

Honeywell

Honeywell Teknoloji A.Ş.
www.honeywell.com

Şirket / Müşteri : Esan Eczacıbaşı Endüstriyel Hammaddeler San. ve Tic. A.Ş.
(Company / Customer)

Yetkili : Önder KURT
(Commision)

esan

Proje Adı : ESAN Çine ÜYS 1.Faz_Kurutma3
(Project Name)

Döküman Adı :
(Project Name)

Proje Numarası : 210510
(Project Number)

Proje Sorumlusu : Yağmur KEPEZ
(Project Manager)

Oluşturma Tarihi : 20.04.2022
(Creation Date)

Güç Beslemesi 400 V 50 Hz
(Power Supply)

Kumanda Voltajı 24 V DC
(Control Voltage)

Proje Onay :

Toplam Sayfa : 139
(Total Page)

Çizen (Drawing) Necip SERT Proje Tasarım	Kontrol (Control) Elc. / Eln. Eng. Mehmet CAN EMO Number : 34502		Kontrol (Control) Proje Sorumlusu Yağmur KEPEZ		Sayfa açıklaması (Page description) Kapak Sayfası	Proje adı (Project name) ESAN Çine ÜYS 1.Faz_Kurutma3	= + Next page: &AAB1/1 Previous page:
--	--	---	--	---	--	--	--

İçindekiler dizini

Sayfa	Sayfa açıklaması	Tag Number	Lokasyon	Tarih	X
/1	Kapak Sayfası			6.05.2022	X
&AAB1/1	Kapak Sayfası			6.05.2022	X
&AAB1/2	İçindekiler dizini			17.04.2024	
&AAB1/2.1	İçindekiler dizini			17.04.2024	
&AAB1/2.2	İçindekiler dizini			17.04.2024	
&AAB1/2.3	İçindekiler dizini			17.04.2024	
&AAB1/2.4	İçindekiler dizini			17.04.2024	
=GB1+A2.B2/1	Açıklama Sayfası	KURUTMA 3		6.05.2022	X
=GB1+A2.B2/11.a	Ana Şalter Güç Devresi			15.08.2022	
=GB1+A2.B2/11.b	Ana Şalter Kumanda Devresi - 1			25.07.2022	
=GB1+A2.B2/11.c	Ana Şalter Analizör Devresi			25.07.2022	
=GB1+A2.B2/11.d	Ana Şalter Acil Stop Devresi			17.04.2024	
=GB1+A2.B2/11.e	Ana Şalter Kumanda Devresi - 2			25.07.2022	
=GB1+A2.B2/13.a	Güç Kaynağı			6.05.2022	
=GB1+A2.B2/13.b	Güç Kaynağı Dağıtım			6.05.2022	
=GB1+A2.B2/14	DCS Haberleşme			15.04.2024	
=GB1+A2.B2/15.a	Havalandırma Ve Aydınlatma - 1			6.05.2022	
=GB1+A2.B2/15.b	Havalandırma Ve Aydınlatma - 2			6.05.2022	
=GB1+A2.B2/15.c	Havalandırma Ve Aydınlatma - 3			6.05.2022	
=GB1+A2.B2/21.a	YEDEK-1		MCC-13	16.04.2024	
=GB1+A2.B2/21.b	YEDEK-1		MCC-13	16.04.2024	
=GB1+A2.B2/21.c	YEDEK-1		MCC-13	16.04.2024	
=GB1+A2.B2/22.a	YEDEK 2		MCC-13	16.04.2024	
=GB1+A2.B2/22.b	YEDEK 2		MCC-13	16.04.2024	
=GB1+A2.B2/22.c	YEDEK 2		MCC-13	16.04.2024	
=GB1+A2.B2/23.a	YEDEK 3		MCC-13	16.04.2024	
=GB1+A2.B2/23.b	YEDEK 3		MCC-13	16.04.2024	
=GB1+A2.B2/23.c	YEDEK 3		MCC-13	16.04.2024	
=GB1+A2.B2/24.a	YEDEK 4		MCC-13	16.04.2024	
=GB1+A2.B2/24.b	YEDEK 4		MCC-13	16.04.2024	
=GB1+A2.B2/24.c	YEDEK 4		MCC-13	16.04.2024	
=GB1+A2.B2/25.a	Besleme Bandı-1	DRY3-CNV001-XM1	MCC-8.3	15.04.2024	
=GB1+A2.B2/25.b	Besleme Bandı-1	DRY3-CNV001-XM1	MCC-8.3	15.04.2024	

Çizen (Drawing)	Kontrol (Control)		Kontrol (Control)		Sayfa açıklaması (Page description)	Proje adı (Project name)	=
Necip SERT Proje Tasarım	Elc. / Eln. Eng. Mehmet CAN EMO Number : 34502		Proje Sorumlusu Yağmur KEPEZ		İçindekiler dizini	ESAN Çine ÜYS 1.Faz_Kurutma3	+
							Next page: 2.1
					Previous page: 1		

İçindekiler dizini

Sayfa	Sayfa açıklaması	Tag Number	Lokasyon	Tarih	X
=GB1+A2.B2/25.c	Besleme Bandı-1	DRY3-CNV001-XM1	MCC-8.3	15.04.2024	
=GB1+A2.B2/26.a	YEDEK		MCC-8.4	15.04.2024	
=GB1+A2.B2/26.b	YEDEK		MCC-8.4	15.04.2024	
=GB1+A2.B2/26.c	YEDEK		MCC-8.4	15.04.2024	
=GB1+A2.B2/27.a	YEDEK		MCC-6.1	15.04.2024	
=GB1+A2.B2/27.b	YEDEK		MCC-6.1	15.04.2024	
=GB1+A2.B2/27.c	YEDEK		MCC-6.1	15.04.2024	
=GB1+A2.B2/28.a	Fırın-3 Döndürme Motoru	DRY3-DRY001-XM1	MCC-2.1	17.04.2024	
=GB1+A2.B2/28.b	Fırın-3 Döndürme Motoru	DRY3-DRY001-XM1	MCC-2.1	17.04.2024	
=GB1+A2.B2/28.c	Fırın-3 Döndürme Motoru	DRY3-DRY001-XM1	MCC-2.1	17.04.2024	
=GB1+A2.B2/30.a	Fırın 3 Çıkış Vibro İletici	DRY3-VFR001-XM1	MCC-4.1	15.04.2024	
=GB1+A2.B2/30.b	Fırın 3 Çıkış Vibro İletici	DRY3-VFR001-XM1	MCC-4.1	15.04.2024	
=GB1+A2.B2/30.c	Fırın 3 Çıkış Vibro İletici	DRY3-VFR001-XM1	MCC-4.1	15.04.2024	
=GB1+A2.B2/31.a	Fırın 3 Çıkış Elevatörü	DRY3-ELV001-XM1	MCC-11.1	15.04.2024	
=GB1+A2.B2/31.b	Fırın 3 Çıkış Elevatörü	DRY3-ELV001-XM1	MCC-11.1	15.04.2024	
=GB1+A2.B2/31.c	Fırın 3 Çıkış Elevatörü	DRY3-ELV001-XM1	MCC-11.1	15.04.2024	
=GB1+A2.B2/32.a	YEDEK		MCC-6.2	15.04.2024	
=GB1+A2.B2/32.b	YEDEK		MCC-6.2	15.04.2024	
=GB1+A2.B2/32.c	YEDEK		MCC-6.2	15.04.2024	
=GB1+A2.B2/34.a	8.elek üstü besleme silosu rotary valf	DRY3-FDV001-XM1	MCC-8.2	15.04.2024	
=GB1+A2.B2/34.b	8.elek üstü besleme silosu rotary valf	DRY3-FDV001-XM1	MCC-8.2	15.04.2024	
=GB1+A2.B2/34.c	8.elek üstü besleme silosu rotary valf	DRY3-FDV001-XM1	MCC-8.2	15.04.2024	
=GB1+A2.B2/35.a	Fırın 3 Çıkış Bandı-1	DRY3-CNV003-XM1	MCC-6.3	15.04.2024	
=GB1+A2.B2/35.b	Fırın 3 Çıkış Bandı-1	DRY3-CNV003-XM1	MCC-6.3	17.04.2024	
=GB1+A2.B2/35.c	Fırın 3 Çıkış Bandı-1	DRY3-CNV003-XM1	MCC-6.3	15.04.2024	
=GB1+A2.B2/36.a	YEDEK		MCC-6.4	15.04.2024	
=GB1+A2.B2/36.b	YEDEK		MCC-6.4	15.04.2024	
=GB1+A2.B2/36.c	YEDEK		MCC-6.4	15.04.2024	
=GB1+A2.B2/37.a	Fırın 3 Çıkış Alger Elevatörü	DRY3-ELV003-XM1	MCC-9.1	15.04.2024	
=GB1+A2.B2/37.b	Fırın 3 Çıkış Alger Elevatörü	DRY3-ELV003-XM1	MCC-9.1	15.04.2024	
=GB1+A2.B2/37.c	Fırın 3 Çıkış Alger Elevatörü	DRY3-ELV003-XM1	MCC-9.1	15.04.2024	
=GB1+A2.B2/38.a	Fırın 3 Filtre Fan Motor	DRY3-FTV001-XM1	MCC-15.1	15.04.2024	
=GB1+A2.B2/38.b	Fırın 3 Filtre Fan Motor	DRY3-FTV001-XM1	MCC-15.1	15.04.2024	

Çizen (Drawing)	Kontrol (Control)			Sayfa açıklaması (Page description)	Proje adı (Project name)	=	
Necip SERT Proje Tasarım	Elc. / Eln. Eng. Mehmet CAN EMO Number : 34502			Proje Sorumlusu Yağmur KEPEZ	İçindekiler dizini	ESAN Çine ÜYS 1.Faz_Kurutma3	+
							Next page: 2.2
					Previous page: 2		

İçindekiler dizini

Sayfa	Sayfa açıklaması	Tag Number	Lokasyon	Tarih	X
=GB1+A2.B2/38.c	Fırın 3 Filtre Fan Motor	DRY3-FTV001-XM1	MCC-15.1	15.04.2024	
=GB1+A2.B2/39.a	Fırın 3 Filtre Rotary Valfi	DRY3-FDV002-XM1	MCC-8.1	15.04.2024	
=GB1+A2.B2/39.b	Fırın 3 Filtre Rotary Valfi	DRY3-FDV002-XM1	MCC-8.1	15.04.2024	
=GB1+A2.B2/39.c	Fırın 3 Filtre Rotary Valfi	DRY3-FDV002-XM1	MCC-8.1	15.04.2024	
=GB1+A2.B2/41.a	Vibro İletici 1	DRY3-VFR002-XM1	MCC-4.2	15.04.2024	
=GB1+A2.B2/41.b	Vibro İletici 1	DRY3-VFR002-XM1	MCC-4.2	15.04.2024	
=GB1+A2.B2/41.c	Vibro İletici 1	DRY3-VFR002-XM1	MCC-4.2	15.04.2024	
=GB1+A2.B2/42.a	Vibro İletici 2	DRY3-VFR003-XM1	MCC-4.3	15.04.2024	
=GB1+A2.B2/42.b	Vibro İletici 2	DRY3-VFR003-XM1	MCC-4.3	16.04.2024	
=GB1+A2.B2/42.c	Vibro İletici 2	DRY3-VFR003-XM1	MCC-4.3	16.04.2024	
=GB1+A2.B2/119	ÇIKIŞLAR - 1		MCC-13	16.04.2024	
=GB1+A2.B2/120	ÇIKIŞLAR-2		MCC-13	16.04.2024	
=GB1+A2.B2/121	ÇIKIŞLAR-3		MCC-13	16.04.2024	
=GB1+A2.B3&EFA1/1	Açıklama Sayfası	KURUTMA 3		6.05.2022	X
=GB1+A2.B3&EFA1/11	2130R03S01 DI OWERWIEW			6.05.2022	
=GB1+A2.B3&EFA1/12	2130R03S02 DI OWERWIEW			6.05.2022	
=GB1+A2.B3&EFA1/13	2130R03S03 DI OWERWIEW			6.05.2022	
=GB1+A2.B3&EFA1/14	2130R03S04 DI OWERWIEW			6.05.2022	
=GB1+A2.B3&EFA1/15	2130R03S05 DO OWERWIEW			6.05.2022	
=GB1+A2.B3&EFA1/16	2130R03S06 AI OWERWIEW			6.05.2022	
=GB1+A2.B3&EFA1/17	2130R03S07 AI OWERWIEW			6.05.2022	
=GB1+A2.B3&EFA1/18	2130R03S08 AI OWERWIEW			6.05.2022	
=GB1+A2.B3&EFA1/19	2130R03S09 AI OWERWIEW			6.05.2022	
=GB1+A2.B3&EFA1/20	2130R03S10 AO OWERWIEW			6.05.2022	
=GB1+A2.B3&EFA1/21	2130R03S11 AO OWERWIEW			6.05.2022	
=GB1+A2.B3&EFA1/22	2130R03S12			6.05.2022	
=GB1+A2.B3&EFA1/31	2130R04S01			6.05.2022	
=GB1+A2.B3&EFA1/32	2130R04S02			6.05.2022	
=GB1+A2.B3&EFA1/33	2130R04S03			6.05.2022	
=GB1+A2.B3&EFA1/34	2130R04S04			6.05.2022	
=GB1+A2.B3&EFA1/35	2130R04S05			6.05.2022	
=GB1+A2.B3&EFA1/36	2130R04S06			6.05.2022	
=GB1+A2.B3&EFA1/37	2130R04S07			6.05.2022	

Çizen (Drawing)	Kontrol (Control)		Kontrol (Control)		Sayfa açıklaması (Page description)	Proje adı (Project name)	=
Necip SERT Proje Tasarım	Elc. / Eln. Eng. Mehmet CAN EMO Number : 34502		Proje Sorumlusu Yağmur KEPEZ		İçindekiler dizini	ESAN Çine ÜYS 1.Faz_Kurutma3	+
							Next page: 2.3
					Previous page: 2.1		

İçindekiler dizini

Sayfa	Sayfa açıklaması	Tag Number	Lokasyon	Tarih	X
=GB1+A2.B3&EFA1/38	2130R04S08			6.05.2022	
=GB1+A2.B3&EFA1/39	2130R04S09			6.05.2022	
=GB1+A2.B3&EFA1/40	2130R04S10			6.05.2022	
=GB1+A2.B3&EFA1/41	2130R04S11			6.05.2022	
=GB1+A2.B3&EFA1/42	2130R04S12			6.05.2022	
=GB1+A2.B3&EFS1/1	Açıklama Sayfası	KURUTMA 3		6.05.2022	X
=GB1+A2.B3&EFS1/11	Güç Sayfası - 1			18.07.2022	
=GB1+A2.B3&EFS1/13.a	Güç Kaynağı - 1			6.07.2022	
=GB1+A2.B3&EFS1/13.b	Güç Kaynağı - 2			6.07.2022	
=GB1+A2.B3&EFS1/14	Havalandırma Ve Aydınlatma-1			6.07.2022	
=GB1+A2.B3&EFS1/16.a	RACK - 03 24VDC Modül Besleme Dağıtım			6.05.2022	
=GB1+A2.B3&EFS1/16.b	RACK - 03 24VDC Terminal Besleme Dağıtım			17.04.2024	
=GB1+A2.B3&EFS1/17.a	RACK - 04 24VDC Modül Besleme Dağıtım			6.05.2022	
=GB1+A2.B3&EFS1/17.b	RACK - 04 24VDC Terminal Besleme Dağıtım			6.05.2022	
=GB1+A2.B3&EFS1/23	Network Ağ Bağlantıları			7.07.2022	
=GB1+A2.B3&EFS1/24	REDUNDANT CPU 24VDC Besleme			13.07.2022	
=GB1+A2.B3&EFS1/25	RACK - 03 24VDC Modül Besleme			13.07.2022	
=GB1+A2.B3&EFS1/26	RACK - 04 24VDC Modül Besleme			6.05.2022	
=GB1+A2.B3&EFS1/31.a	RACK - 3 SLOT - 1 Digital Input (32 Channel) (1-16) 2 WIRE			17.04.2024	
=GB1+A2.B3&EFS1/31.b	RACK - 3 SLOT - 1 Digital Input (32 Channel) (17-32) 2 WIRE			17.04.2024	
=GB1+A2.B3&EFS1/32.a	RACK - 3 SLOT - 2 Digital Input (32 Channel) (1-16) 2 WIRE			17.04.2024	
=GB1+A2.B3&EFS1/32.b	RACK - 3 SLOT - 2 Digital Input (32 Channel) (17-32) 2 WIRE			17.04.2024	
=GB1+A2.B3&EFS1/33.a	RACK - 3 SLOT - 3 Digital Input (32 Channel) (1-16) 2 WIRE			17.04.2024	
=GB1+A2.B3&EFS1/33.b	RACK - 3 SLOT - 3 Digital Input (32 Channel) (17-32) 2 WIRE			17.04.2024	
=GB1+A2.B3&EFS1/34.a	RACK - 3 SLOT - 4 Digital Input (32 Channel) (1-16) 2 WIRE			17.04.2024	
=GB1+A2.B3&EFS1/34.b	RACK - 3 SLOT - 4 Digital Input (32 Channel) (17-32) 3 WIRE			17.04.2024	
=GB1+A2.B3&EFS1/35.a	RACK - 3 SLOT - 5 Digital Output (32 Channel) (1-8) DRY CONTACT			17.04.2024	
=GB1+A2.B3&EFS1/35.b	RACK - 3 SLOT - 5 Digital Output (32 Channel) (9-16) DRY CONTACT			17.04.2024	
=GB1+A2.B3&EFS1/35.c	RACK - 3 SLOT - 5 Digital Output (32 Channel) (17-22) DRY CONTACT			17.04.2024	
=GB1+A2.B3&EFS1/35.d	RACK - 3 SLOT - 5 Digital Output (32 Channel) (23-32) LİVE CONTACT			17.04.2024	
=GB1+A2.B3&EFS1/36.a	RACK - 3 SLOT - 6 Analog Input (16 Channel) (1-8) HI LEVEL			17.04.2024	
=GB1+A2.B3&EFS1/36.b	RACK - 3 SLOT - 6 Analog Input (16 Channel) (9-16) HI LEVEL			17.04.2024	
=GB1+A2.B3&EFS1/37.a	RACK - 3 SLOT - 7 Analog Input (8 Channel) (1-4) RTD			17.04.2024	

Çizen (Drawing)	Kontrol (Control)		Kontrol (Control)		Sayfa açıklaması (Page description)	Proje adı (Project name)	=
Necip SERT Proje Tasarım	Elc. / Eln. Eng. Mehmet CAN EMO Number : 34502		Proje Sorumlusu Yağmur KEPEZ		İçindekiler dizini	ESAN Çine ÜYS 1.Faz_Kurutma3	+
							Next page: 2.4
					Previous page: 2.2		

Honeywell

Honeywell Teknoloji A.Ş.
www.honeywell.com

ESAN Çine ÜYS 1.Faz_Kurutma3

KURUTMA 3

= GB1

2130UOC01

+ A2.B3

DCS

+ EFA1

Genel bakış PLC

Çizen (Drawing)	Kontrol (Control)	ARKPAN® imagineering solutions™	Kontrol (Control)	Honeywell	Sayfa açıklaması (Page description)	Proje adı (Project name)	= GB1
Necip SERT Proje Tasarım	Elc. / Eln. Eng. Mehmet CAN EMO Number : 34502		Proje Sorumlusu Yağmur KEPEZ		Açıklama Sayfası KURUTMA 3	ESAN Çine ÜYS 1.Faz_Kurutma3	+ A2.B3
							Next page: 11
							Previous page: +B2&/121



-R03S01
&EFS1/ 25.1

DI 32x24VDC

HONEYWELL

DCS PANOSU KAPAKLARI KAPALI / AÇIK	-14S35:14	-X10:1 01		-X10:19 17	17	VİBRO İLETİCİ 1 MOTORU ÇALIŞTI
DCS PANOSU SICAKLIK NORMAL / YÜKSEK	-14S31:14	-X10:2 02		-X10:20 18	18	VİBRO İLETİCİ 1 MOTORU TERMİK
DCS PANOSU GUC KAYNAGI 1 NORMAL / ARIZA	-13RL1:24	-X10:3 03		-X10:21 19	19	VİBRO İLETİCİ 1 MOTORU LOKAL REMOTE
DCS PANOSU GUC KAYNAGI 2 NORMAL / ARIZA	-13RL2:24	-X10:4 04		-X10:22 20	20	VİBRO İLETİCİ 1 MOTORU BAKIM ŞALTERİ
DCS PANOSU ŞEBEKE ENERJİSİ NORMAL / HATA	-11RL1:24	-X10:5 05		-X10:23 21	21	VİBRO İLETİCİ 1 MOTORU MCC SICAKLIK
DCS PANOSU UPS ENERJİSİ NORMAL / HATA	-11RL2:24	-X10:6 06		-X10:24 22	22	VİBRO İLETİCİ 2 MOTORU ÇALIŞTI
DCS DİYOT MODÜLÜ ALARM BİLGİSİ	07	-X10:7 07		-X10:25 23	23	VİBRO İLETİCİ 2 MOTORU TERMİK
DCS DİYOT MODÜLÜ BATTERY MOD	08	-X10:8 08		-X10:26 24	24	VİBRO İLETİCİ 2 MOTORU LOKAL REMOTE
MCC PANOSU FAZ KORUMA ROLESİ NORMAL / HATA	+B2-11RL1:34	-X10:9 09		-X10:27 25	25	VİBRO İLETİCİ 2 MOTORU BAKIM ŞALTERİ
MCC PANOSU ACİL STOP BUTONU NORMAL / BASILI	+B2-12RL1:24	-X10:10 10		-X10:28 26	26	VİBRO İLETİCİ 2 MOTORU MCC SICAKLIK
KONTROL ODASI ACİL STOP BUTONU NORMAL / BASILI	+B2-12RL2:24	-X10:11 11		-X10:29 27	27	YEDEK
TOROİD KAÇAK AKIM NORMAL / AÇMA	+B2-11RL2:24	-X10:12 12		-X10:30 28	28	YEDEK
MCC PANOSU GUC KAYNAGI 1 NORMAL / ARIZA	+B2-13RL1:14	-X10:13 13		-X10:31 29	29	YEDEK
MCC PANOSU GUC KAYNAGI 2 NORMAL / ARIZA	+B2-13RL2:14	-X10:14 14		-X10:32 30	30	YEDEK
MCC PANOSU ANA ŞALTER MAN BİLGİSİ	+B2-12RL3:14	-X10:15 15		-X10:33 31	31	YEDEK
MCC PANOSU ANA ŞALTER AUTO BİLGİSİ	+B2-12RL4:14	-X10:16 16		-X10:34 32	32	YEDEK
		-X10:17		-X10:35		
		-X10:18		-X10:36		

900G32-0101

Çizen (Drawing)	Kontrol (Control)		Kontrol (Control)		Sayfa açıklaması (Page description)	Proje adı (Project name)	=	GB1
Necip SERT Proje Tasarım	Elc. / Eln. Eng. Mehmet CAN EMO Number : 34502		Proje Sorumlusu Yağmur KEPEZ		2130R03S01 DI OWERWIEW	ESAN Çine ÜYS 1.Faz_Kurutma3	+	AZ.B3
							Next page:	12
							Previous page:	1



-R03S02
&EFS1/ 25.2

DI 32x24VDC

HONEYWELL

YEDEK	01	-X10:1 01		-X10:19 17	17	BESLEME BANDI 2 MOTORU BANT KAYDI
YEDEK	02	-X10:2 02		-X10:20 18	18	BRULOR SEKONDER FAN MOTORU MOTORU ÇALIŞTI
YEDEK	03	-X10:3 03		-X10:21 19	19	BRULOR SEKONDER FAN MOTORU MOTORU TERMİK
YEDEK	04	-X10:4 04		-X10:22 20	20	BRULOR SEKONDER FAN MOTORU MOTORU LOKAL REMOTE
YEDEK	05	-X10:5 05		-X10:23 21	21	BRULOR SEKONDER FAN MOTORU MOTORU BAKIM ŞALTERİ
BESLEME BANDI 1 MOTORU ÇALIŞTI	06	-X10:6 06		-X10:24 22	22	FIRIN 3 DONDURME MOTORU ÇALIŞTI
BESLEME BANDI 1 MOTORU TERMİK	07	-X10:7 07		-X10:25 23	23	FIRIN 3 DONDURME MOTORU MOTORU TERMİK
BESLEME BANDI 1 MOTORU LOKAL REMOTE	08	-X10:8 08		-X10:26 24	24	FIRIN 3 DONDURME MOTORU MOTORU LOKAL REMOTE
BESLEME BANDI 1 MOTORU BAKIM ŞALTERİ	09	-X10:9 09		-X10:27 25	25	FIRIN 3 DONDURME MOTORU MOTORU BAKIM ŞALTERİ
BESLEME BANDI 1 MOTORU İPLİ EMNİYET ŞALTERİ	10	-X10:10 10		-X10:28 26	26	FIRIN 3 VİBRO İLETİCİ MOTORU ÇALIŞTI
BESLEME BANDI 1 MOTORU BANT KAYDI	11	-X10:11 11		-X10:29 27	27	FIRIN 3 VİBRO İLETİCİ MOTORU TERMİK
BESLEME BANDI 2 MOTORU ÇALIŞTI	12	-X10:12 12		-X10:30 28	28	FIRIN 3 VİBRO İLETİCİ MOTORU LOKAL REMOTE
BESLEME BANDI 2 MOTORU TERMİK	13	-X10:13 13		-X10:31 29	29	FIRIN 3 VİBRO İLETİCİ MOTORU BAKIM ŞALTERİ
BESLEME BANDI 2 MOTORU LOKAL REMOTE	14	-X10:14 14		-X10:32 30	30	FIRIN 3 VİBRO İLETİCİ MOTORU MCC SICAKLIK
BESLEME BANDI 2 MOTORU BAKIM ŞALTERİ	15	-X10:15 15		-X10:33 31	31	BRULOR ÇALIŞTI
BESLEME BANDI 2 MOTORU İPLİ EMNİYET ŞALTERİ	16	-X10:16 16		-X10:34 32	32	BRULOR ARIZA

900G32-0101

Çizen (Drawing)	Kontrol (Control)		Kontrol (Control)		Sayfa açıklaması (Page description)	Proje adı (Project name)	=	GB1
Necip SERT Proje Tasarım	Elc. / Eln. Eng. Mehmet CAN EMO Number : 34502		Proje Sorumlusu Yağmur KEPEZ		2130R03S02 DI OWERWIEW	ESAN Çine ÜYS 1.Faz_Kurutma3	+	AZ.B3
							Next page:	13
							Previous page:	11



-R03S03
&EFS1/ 25.3

DI 32x24VDC



HONEYWELL

FIRIN 3 ÇIKIŞ KLEPESİ ACIK	01	-X10:1 01		-X10:19 17	17	FIRIN 3 ÇIKIŞ BANDI 1 MOTORU LOKAL REMOTE
FIRIN 3 ÇIKIŞ KLEPESİ KAPALI	02	-X10:2 02		-X10:20 18	18	FIRIN 3 ÇIKIŞ BANDI 1 MOTORU BAKIM ŞALTERİ
FIRIN 3 ÇIKIŞ ELEVATÖRÜ MOTORU ÇALIŞTI	03	-X10:3 03		-X10:21 19	19	FIRIN 3 ÇIKIŞ BANDI 1 MOTORU İPLİ EMNİYET ŞALTERİ
FIRIN 3 ÇIKIŞ ELEVATÖRÜ MOTORU TERMİK	04	-X10:4 04		-X10:22 20	20	FIRIN 3 ÇIKIŞ BANDI 1 MOTORU BANT KAYDI
FIRIN 3 ÇIKIŞ ELEVATÖRÜ MOTORU LOKAL REMOTE	05	-X10:5 05		-X10:23 21	21	FIRIN 3 ÇIKIŞ BANDI 2 MOTORU ÇALIŞTI
FIRIN 3 ÇIKIŞ ELEVATÖRÜ MOTORU BAKIM ŞALTERİ	06	-X10:6 06		-X10:24 22	22	FIRIN 3 ÇIKIŞ BANDI 2 MOTORU TERMİK
NÖLTEK PNOMATİK BESLEME ELEVATÖRÜ ÇALIŞTI	07	-X10:7 07		-X10:25 23	23	FIRIN 3 ÇIKIŞ BANDI 2 MOTORU LOKAL REMOTE
NÖLTEK PNOMATİK BESLEME ELEVATÖRÜ TERMİK	08	-X10:8 08		-X10:26 24	24	FIRIN 3 ÇIKIŞ BANDI 2 MOTORU BAKIM ŞALTERİ
NÖLTEK PNOMATİK BESLEME ELEVATÖRÜ LOKAL REMOTE	09	-X10:9 09		-X10:27 25	25	FIRIN 3 ÇIKIŞ BANDI 2 MOTORU İPLİ EMNİYET ŞALTERİ
NÖLTEK PNOMATİK BESLEME ELEVATÖRÜ BAKIM ŞALTERİ	10	-X10:10 10		-X10:28 26	26	FIRIN 3 ÇIKIŞ BANDI 2 MOTORU BANT KAYDI
8.ELEK ÜSTÜ BESLEME SİLOSU ROTARY VALF ÇALIŞTI	11	-X10:11 11		-X10:29 27	27	FIRIN 3 ÇIKIŞ ALGER ELEVATÖRÜ MOTORU ÇALIŞTI
8.ELEK ÜSTÜ BESLEME SİLOSU ROTARY VALF TERMİK	12	-X10:12 12		-X10:30 28	28	FIRIN 3 ÇIKIŞ ALGER ELEVATÖRÜ MOTORU TERMİK
8.ELEK ÜSTÜ BESLEME SİLOSU ROTARY VALF LOKAL REMOTE	13	-X10:13 13		-X10:31 29	29	FIRIN 3 ÇIKIŞ ALGER ELEVATÖRÜ MOTORU LOKAL REMOTE
8.ELEK ÜSTÜ BESLEME SİLOSU ROTARY VALF BAKIM ŞALTERİ	14	-X10:14 14		-X10:32 30	30	FIRIN 3 ÇIKIŞ ALGER ELEVATÖRÜ MOTORU BAKIM ŞALTERİ
FIRIN 3 ÇIKIŞ BANDI 1 MOTORU ÇALIŞTI	15	-X10:15 15		-X10:33 31	31	YEDEK
FIRIN 3 ÇIKIŞ BANDI 1 MOTORU TERMİK	16	-X10:16 16		-X10:34 32	32	YEDEK
		-X10:17 17		-X10:35 33		
		-X10:18 18		-X10:36 34		

900G32-0101

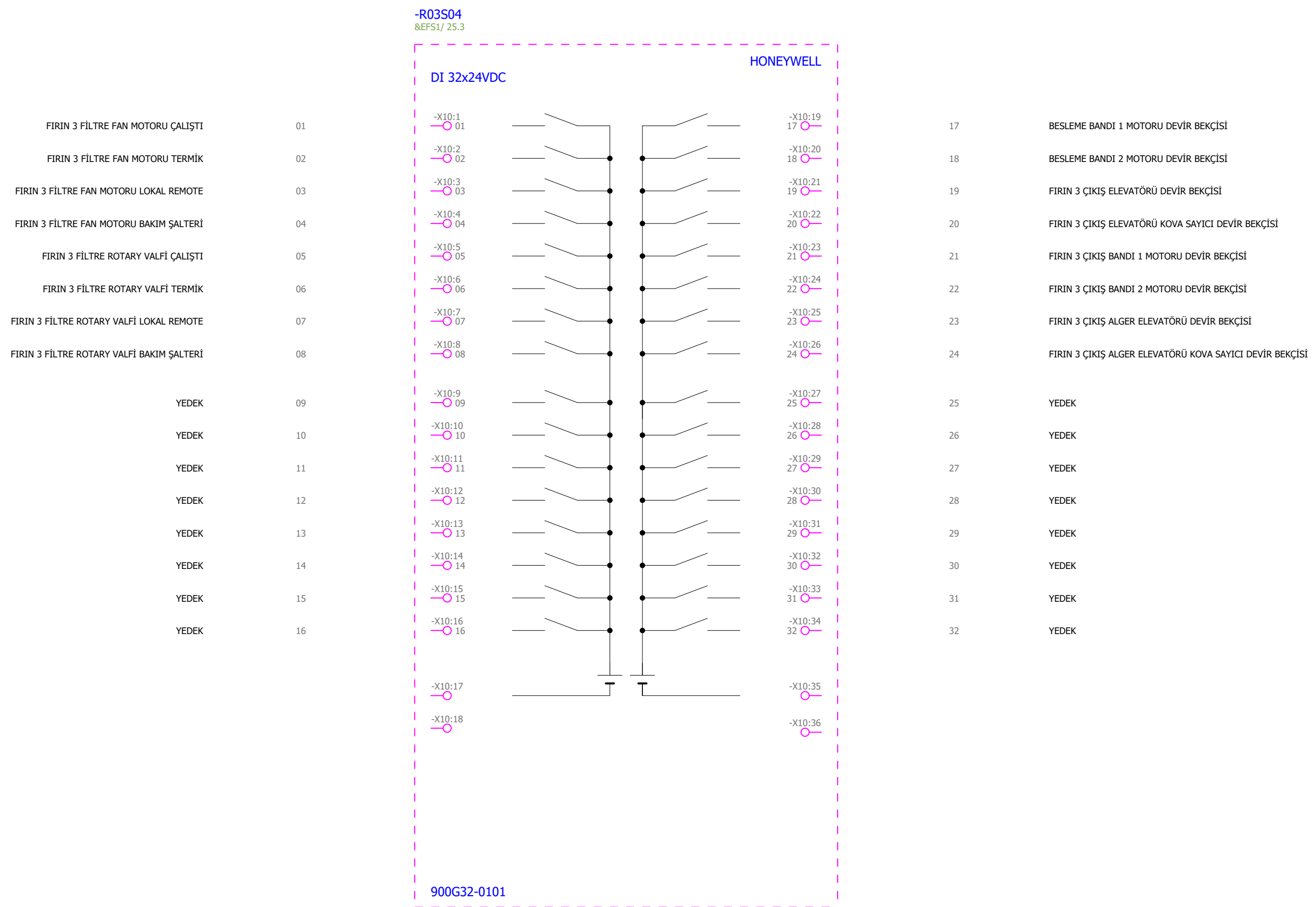
Çizen (Drawing)	Kontrol (Control)		Kontrol (Control)		Sayfa açıklaması (Page description)	Proje adı (Project name)	=	GB1
Necip SERT Proje Tasarım	Elc. / Eln. Eng. Mehmet CAN EMO Number : 34502		Proje Sorumlusu Yağmur KEPEZ		2130R03S03 DI OWERWIEW	ESAN Çine ÜYS 1.Faz_Kurutma3	+	AZ.B3
							Next page:	14
							Previous page:	12



Çizen (Drawing)	Kontrol (Control)		Kontrol (Control)		Sayfa açıklaması (Page description)	Proje adı (Project name)		
Necip SERT Proje Tasarım	Elc. / Eln. Eng. Mehmet CAN EMO Number : 34502		Proje Sorumlusu Yağmur KEPEZ		2130R03S04 DI OWERWIEW	ESAN Çine ÜYS 1.Faz_Kurutma3	=	GB1
							+	A2,B3
							Next page:	15
					Previous page:	13		



-R03S05
&EFS1/ 25.4

DQ 32x24VDC/0.5A

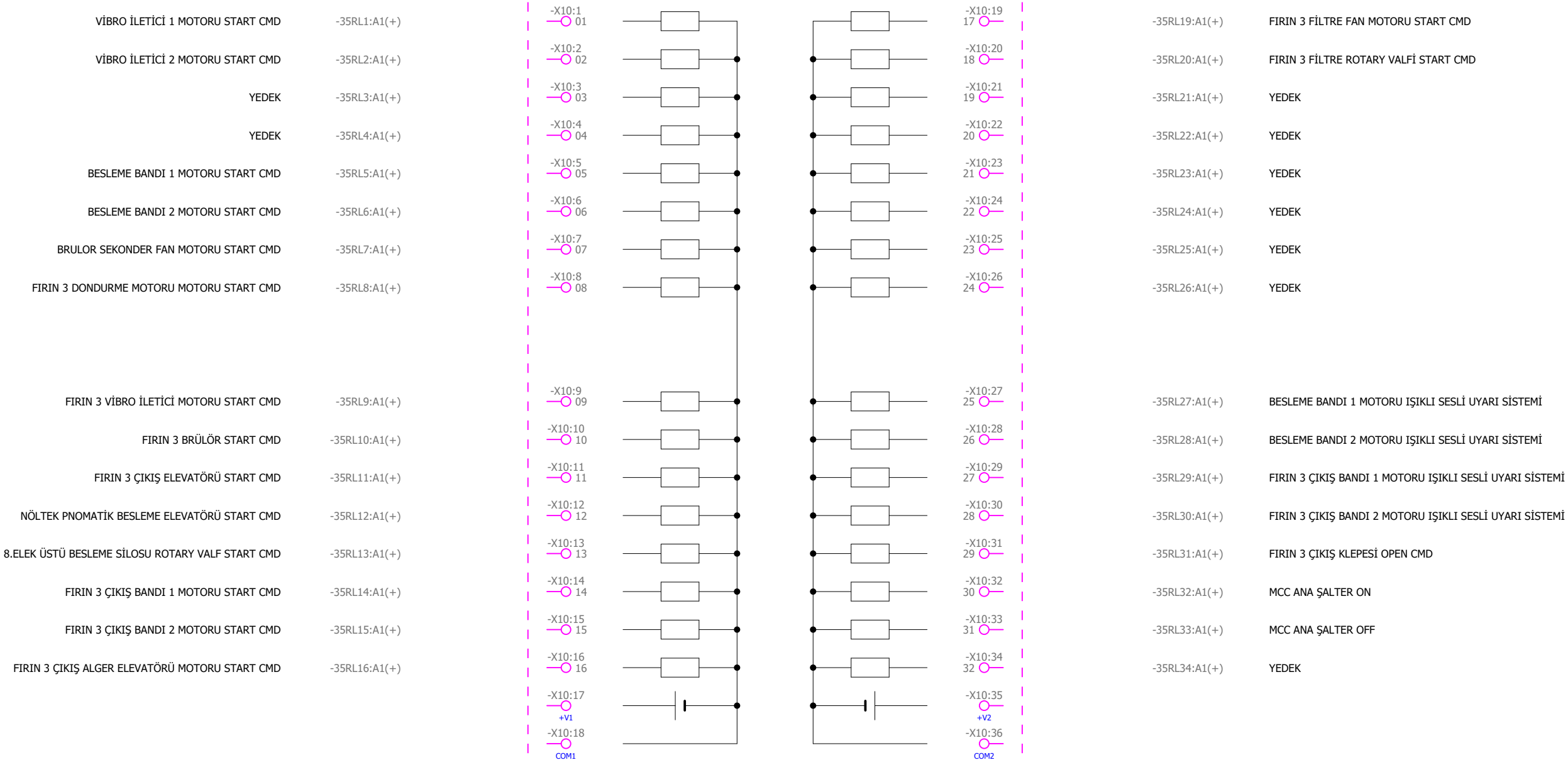
HONEYWELL



900H32-0102

Çizen (Drawing)	Kontrol (Control)		Kontrol (Control)		Sayfa açıklaması (Page description)	Proje adı (Project name)	=	GB1
Necip SERT Proje Tasarım	Elc. / Eln. Eng. Mehmet CAN EMO Number : 34502		Proje Sorumlusu Yağmur KEPEZ		2130R03S05 DO OWERWIEW	ESAN Çine ÜYS 1.Faz_Kurutma3	+	AZ.B3
							Next page:	16
							Previous page:	14

-R03S06
&EFS1/ 25.5

AI 16xI HI LEVEL

HONEYWELL

FIRIN 3 URUN GIRIS NEM DEGERI

1

-X10:1
1+

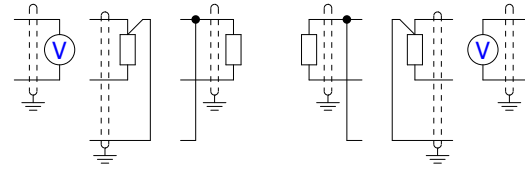

-X10:17
9+

17

FIRIN 3 ÇIKIŞ ELEVATÖRÜ VİBRASYON SENSÖRÜ

FIRIN 3 URUN GIRIS NEM DEGERI

3

-X10:3
1-

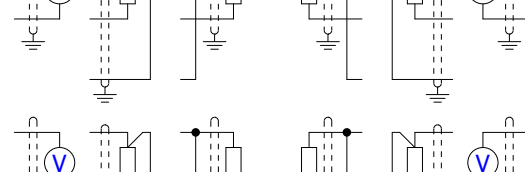

-X10:19
9-

19

FIRIN 3 ÇIKIŞ ELEVATÖRÜ VİBRASYON SENSÖRÜ

FIRIN 3 URUN ÇIKIS NEM DEGERI

4

-X10:2
2+

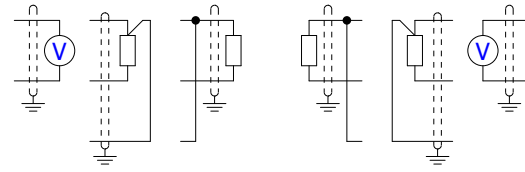

-X10:18
10+

18

ELEME TESİSİ DEĞİRMEN BESLEME SİLOSU SEVİYE

FIRIN 3 VİBRASYON SENSÖRÜ 1

5

-X10:5
3+

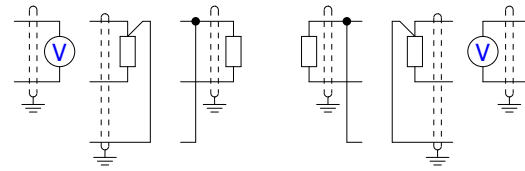

-X10:21
11+

21

FIRIN 3 ÇIKIŞ ALGER ELEVATÖRÜ VİBRASYON SENSÖRÜ

FIRIN 3 VİBRASYON SENSÖRÜ 1

7

-X10:7
3-

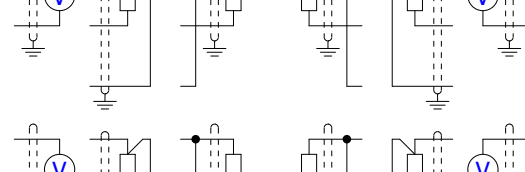

-X10:23
11-

23

FIRIN 3 ÇIKIŞ ALGER ELEVATÖRÜ VİBRASYON SENSÖRÜ

FIRIN 3 VİBRASYON SENSÖRÜ 2

6

-X10:6
4+

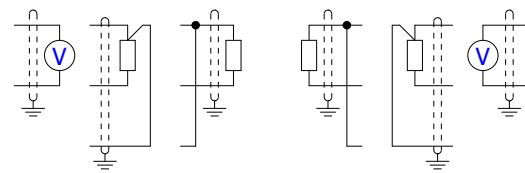

-X10:22
12+

22

ALGER BESLEME SİLOSU SEVİYE

FIRIN 3 VİBRASYON SENSÖRÜ 2

8

-X10:8
4-

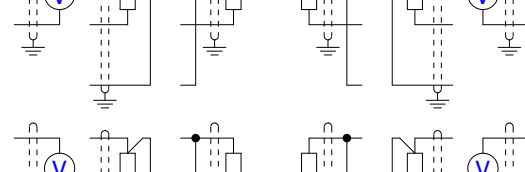

-X10:24
12-

24

ALGER BESLEME SİLOSU SEVİYE

FIRIN 3 VİBRASYON SENSÖRÜ 3

9

-X10:9
5+

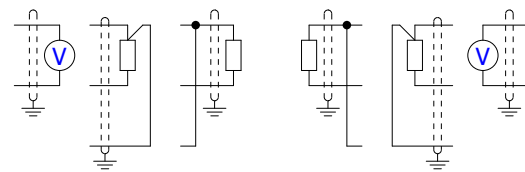

-X10:25
13+

25

FIRIN 3 FİLTRE FAN MOTORU DEBİMETRE

FIRIN 3 VİBRASYON SENSÖRÜ 3

11

-X10:11
5-

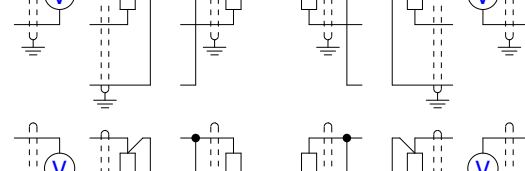

-X10:27
13-

27

FIRIN 3 FİLTRE FAN MOTORU DEBİMETRE

FIRIN 3 VİBRASYON SENSÖRÜ 4

10

-X10:10
6+

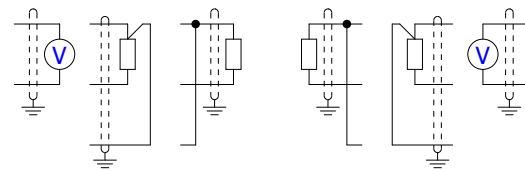

-X10:26
14+

26

FIRIN 3 FİLTRE FAN MOTORU FARK BASINÇ

FIRIN 3 VİBRASYON SENSÖRÜ 4

12

-X10:12
6-

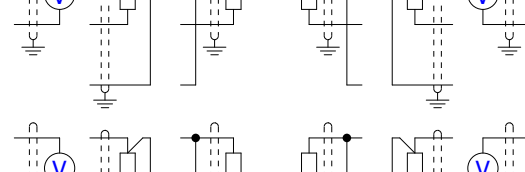

-X10:28
14-

28

FIRIN 3 FİLTRE FAN MOTORU FARK BASINÇ

FIRIN 3 VİBRASYON SENSÖRÜ 5

13

-X10:13
7+

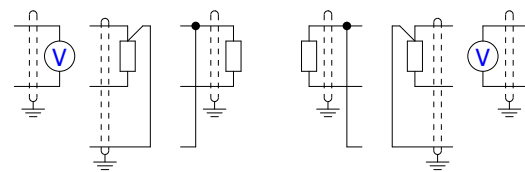

-X10:29
15+

29

FIRIN 3 FİLTRE FAN MOTORU VİBRASYON SENSÖRÜ

FIRIN 3 VİBRASYON SENSÖRÜ 5

15

-X10:15
7-

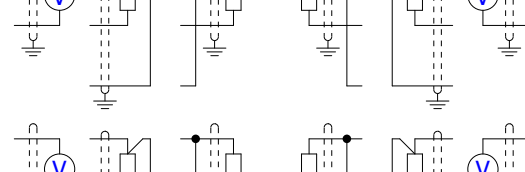

-X10:31
15-

31

FIRIN 3 FİLTRE FAN MOTORU VİBRASYON SENSÖRÜ

FIRIN 3 VİBRASYON SENSÖRÜ 6

14

-X10:14
8+

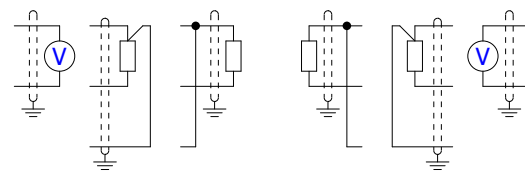

-X10:30
16+

30

YEDEK

FIRIN 3 VİBRASYON SENSÖRÜ 6

16

-X10:16
8-

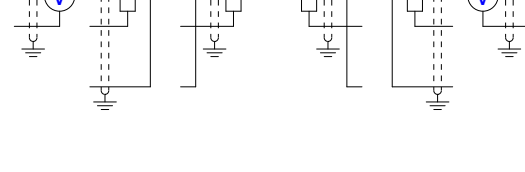



-X10:32
16-

32

YEDEK

900A16-0103

Çizen (Drawing)	Kontrol (Control)		Kontrol (Control)		Sayfa açıklaması (Page description)	Proje adı (Project name)	=	GB1
Necip SERT Proje Tasarım	Elc. / Eln. Eng. Mehmet CAN EMO Number : 34502		Proje Sorumlusu Yağmur KEPEZ		2130R03S06 AI OWERWIEW	ESAN Çine ÜYS 1.Faz_Kurutma3	+	AZ.B3
							Next page:	17
							Previous page:	15

-R03S07
&EFS1/ 25.5

AI 8xU/I/R/RTD BA

HONEYWELL

BESLEME BANDI 1 REDUKTOR SICAKLIGI

1

-X10:1
RTD

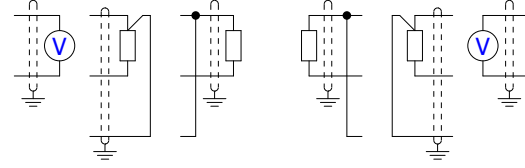

-X10:11
AI5

11

FIRIN 3 URUN CIKIS SICAKLIGI

BESLEME BANDI 1 REDUKTOR SICAKLIGI

2

-X10:2

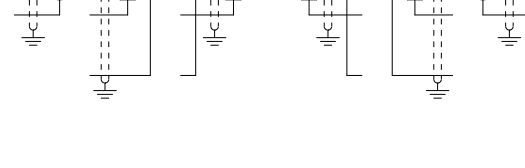

-X10:12
AI5

12

FIRIN 3 URUN CIKIS SICAKLIGI

BESLEME BANDI 1 MOTOR SICAKLIGI

4

-X10:4
AI2

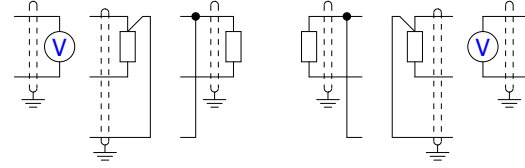

-X10:14
AI6

14

FIRIN 3 ÇIKIŞ ELEVATÖRU REDUKTOR SICAKLIGI

BESLEME BANDI 1 MOTOR SICAKLIGI

5

-X10:5
AI2

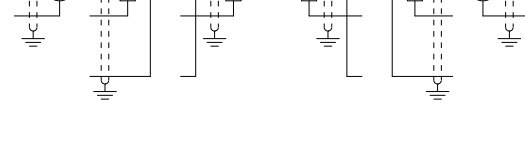

-X10:15
AI6

15

FIRIN 3 ÇIKIŞ ELEVATÖRU REDUKTOR SICAKLIGI

BESLEME BANDI 2 REDUKTOR SICAKLIGI

6

-X10:6
AI3

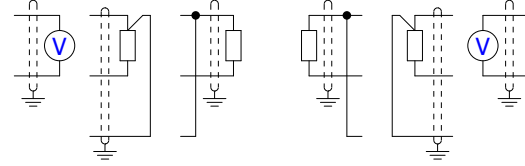

-X10:16
AI7

16

FIRIN 3 ÇIKIŞ ELEVATÖRU MOTOR SICAKLIGI

BESLEME BANDI 2 REDUKTOR SICAKLIGI

7

-X10:7
AI3

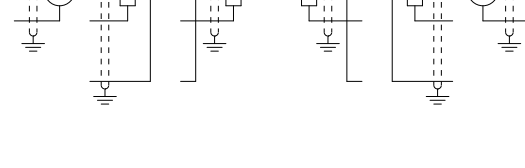

-X10:17
AI7

17

FIRIN 3 ÇIKIŞ ELEVATÖRU MOTOR SICAKLIGI

BESLEME BANDI 2 MOTOR SICAKLIGI

9

-X10:9
AI4

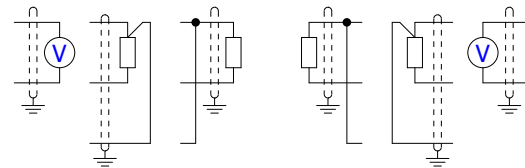

-X10:19
AI8

19

FIRIN 3 ÇIKIŞ ELEVATÖRU RULMAN SICAKLIGI

BESLEME BANDI 2 MOTOR SICAKLIGI

10

-X10:10
AI4

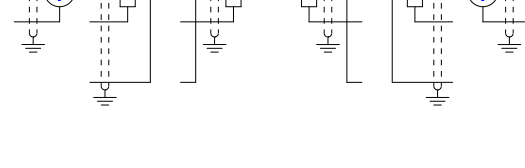



-X10:20
AI8

20

FIRIN 3 ÇIKIŞ ELEVATÖRU RULMAN SICAKLIGI

900A01-0202

Çizen (Drawing)	Kontrol (Control)		Kontrol (Control)		Sayfa açıklaması (Page description)	Proje adı (Project name)	=	GB1
Necip SERT Proje Tasarım	Elc. / Eln. Eng. Mehmet CAN EMO Number : 34502		Proje Sorumlusu Yağmur KEPEZ		2130R03S07 AI OWERWIEW	ESAN Çine ÜYS 1.Faz_Kurutma3	+	A2,B3
							Next page:	18
							Previous page:	16

-R03S08
&EFS1/ 25.6

AI 8xU/I/R/RTD BA

HONEYWELL

FIRIN 3 ÇIKIŞ BANDI 1 REDUKTOR SICAKLIĞI

1

-X10:1
RTD

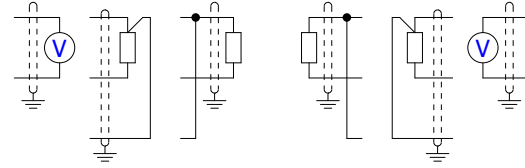

-X10:11
AI5

11

FIRIN 3 ÇIKIŞ ALGER ELEVATÖRU REDUKTOR SICAKLIGI

FIRIN 3 ÇIKIŞ BANDI 1 REDUKTOR SICAKLIĞI

2

-X10:2

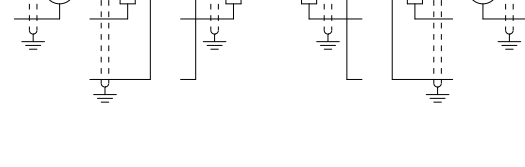

-X10:12
AI5

12

FIRIN 3 ÇIKIŞ ALGER ELEVATÖRU REDUKTOR SICAKLIGI

FIRIN 3 ÇIKIŞ BANDI 1 MOTOR SICAKLIĞI

4

-X10:4
AI2

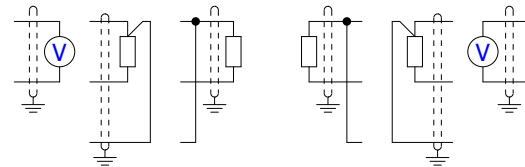

-X10:14
AI6

14

FIRIN 3 ÇIKIŞ ALGER ELEVATÖRU MOTOR SICAKLIGI

FIRIN 3 ÇIKIŞ BANDI 1 MOTOR SICAKLIĞI

5

-X10:5
AI2

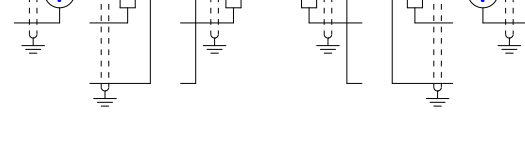

-X10:15
AI6

15

FIRIN 3 ÇIKIŞ ALGER ELEVATÖRU MOTOR SICAKLIGI

FIRIN 3 ÇIKIŞ BANDI 2 REDUKTOR SICAKLIĞI

6

-X10:6
AI3

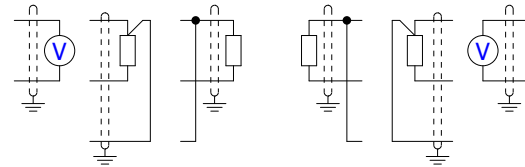

-X10:16
AI7

16

FIRIN 3 ÇIKIŞ ALGER ELEVATÖRU RULMAN SICAKLIGI

FIRIN 3 ÇIKIŞ BANDI 2 REDUKTOR SICAKLIĞI

7

-X10:7
AI3

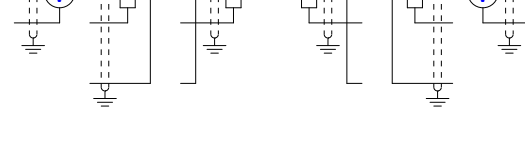

-X10:17
AI7

17

FIRIN 3 ÇIKIŞ ALGER ELEVATÖRU RULMAN SICAKLIGI

FIRIN 3 ÇIKIŞ BANDI 2 MOTOR SICAKLIĞI

9

-X10:9
AI4

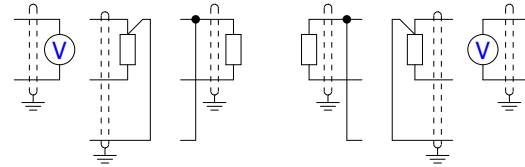

-X10:19
AI8

19

YEDEK

FIRIN 3 ÇIKIŞ BANDI 2 MOTOR SICAKLIĞI

10

-X10:10
AI4

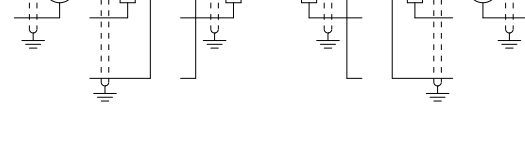



-X10:20
AI8

20

YEDEK

900A01-0202

Çizen (Drawing)	Kontrol (Control)		Kontrol (Control)		Sayfa açıklaması (Page description)	Proje adı (Project name)	=	GB1
Necip SERT Proje Tasarım	Elc. / Eln. Eng. Mehmet CAN EMO Number : 34502		Proje Sorumlusu Yağmur KEPEZ		2130R03S08 AI OWERWIEW	ESAN Çine ÜYS 1.Faz_Kurutma3	+	A2,B3
							Next page:	19
							Previous page:	17

-R03S09
&EFS1/ 25.7

AI 8xU/I/R/RTD BA

HONEYWELL

FIRIN 3 FİLTRE FAN MOTORU SICAKLIGI

1

-X10:1
RTD

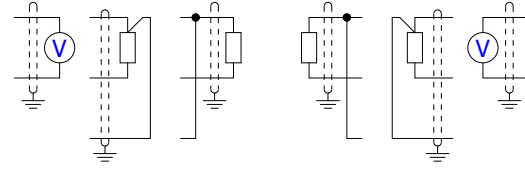

-X10:11
AI5

11

YEDEK

FIRIN 3 FİLTRE FAN MOTORU SICAKLIGI

2

-X10:2

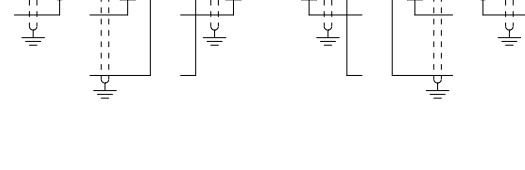

-X10:12
AI5

12

YEDEK

-X10:3

YEDEK

4

-X10:4
AI2

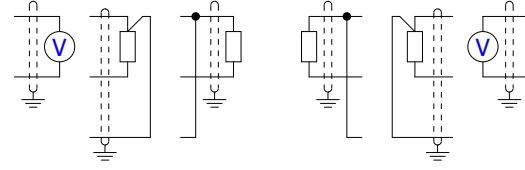

-X10:14
AI6

14

YEDEK

YEDEK

5

-X10:5
AI2

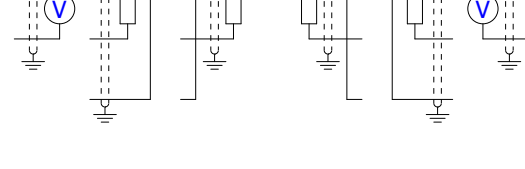

-X10:15
AI6

15

YEDEK

YEDEK

6

-X10:6
AI3

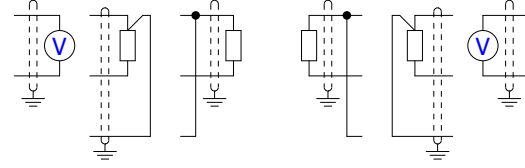

-X10:16
AI7

16

YEDEK

YEDEK

7

-X10:7
AI3

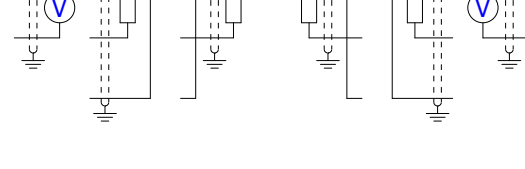

-X10:17
AI7

17

YEDEK

-X10:8

YEDEK

9

-X10:9
AI4

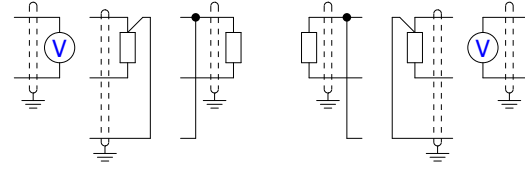

-X10:19
AI8

19

YEDEK

YEDEK

10

-X10:10
AI4

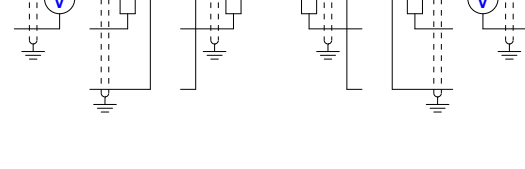



-X10:20
AI8

20

YEDEK

900A01-0202

Çizen (Drawing)	Kontrol (Control)		Kontrol (Control)		Sayfa açıklaması (Page description)	Proje adı (Project name)	=	GB1
Necip SERT Proje Tasarım	Elc. / Eln. Eng. Mehmet CAN EMO Number : 34502		Proje Sorumlusu Yağmur KEPEZ		2130R03S09 AI OWERWIEW	ESAN Çine ÜYS 1.Faz_Kurutma3	+	A2,B3
							Next page:	20
							Previous page:	18

-R03S10
&EFS1/ 25.7

AQ 8xU/I HS

HONEYWELL

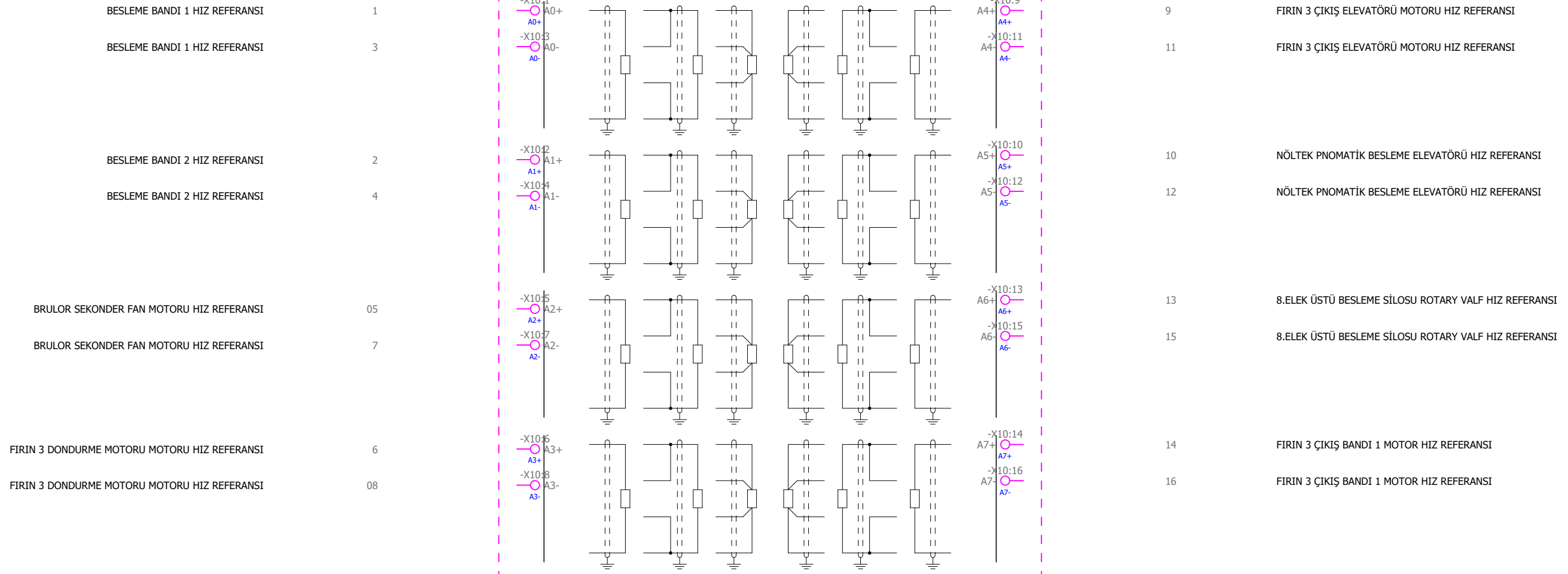

900B08-0202

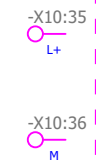

Çizen (Drawing)	Kontrol (Control)		Kontrol (Control)		Sayfa açıklaması (Page description)	Proje adı (Project name)	=	GB1
Necip SERT Proje Tasarım	Elc. / Eln. Eng. Mehmet CAN EMO Number : 34502		Proje Sorumlusu Yağmur KEPEZ		2130R03S10 AO OWERWIEW	ESAN Çine ÜYS 1.Faz_Kurutma3	+	A2.B3
							Next page:	21
							Previous page:	19

-R03S11
&EFS1/ 25.8

AQ 8xU/I HS

HONEYWELL

FIRIN 3 ÇIKIŞ BANDI 2 MOTOR HIZ REFERANSI 1
 FIRIN 3 ÇIKIŞ BANDI 2 MOTOR HIZ REFERANSI 3
 FIRIN 3 ÇIKIŞ ALGER ELEVATÖR MOTOR HIZ REFERANSI 2
 FIRIN 3 ÇIKIŞ ALGER ELEVATÖR MOTOR HIZ REFERANSI 4
 FIRIN 3 FİLTRE FAN MOTORU HIZ REFERANSI 05
 FIRIN 3 FİLTRE FAN MOTORU HIZ REFERANSI 7
 FIRIN 3 FİLTRE ROTARY VALFİ HIZ REFERANSI 6
 FIRIN 3 FİLTRE ROTARY VALFİ HIZ REFERANSI 08

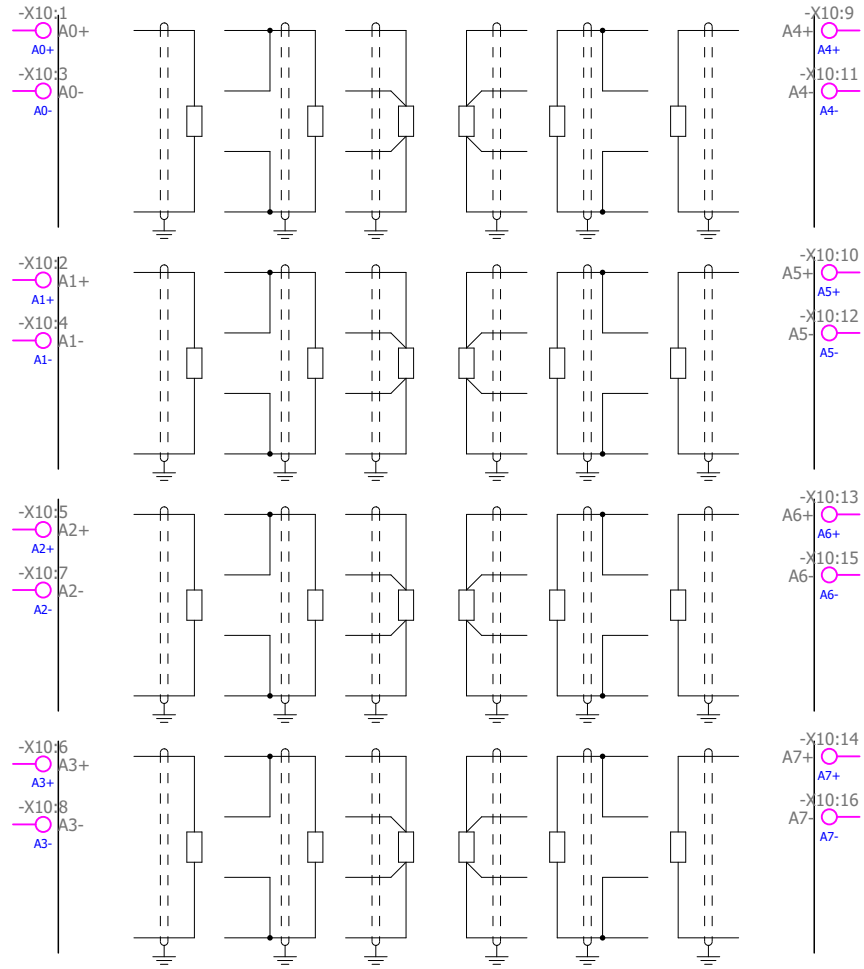



9 YEDEK
 11 YEDEK
 10 YEDEK
 12 YEDEK
 13 YEDEK
 15 YEDEK
 14 YEDEK
 16 YEDEK

900B08-0202

-X10:35
L+

-X10:36
M

Çizen (Drawing)	Kontrol (Control)		Kontrol (Control)		Sayfa açıklaması (Page description)	Proje adı (Project name)	=	GB1
Necip SERT Proje Tasarım	Elc. / Eln. Eng. Mehmet CAN EMO Number : 34502		Proje Sorumlusu Yağmur KEPEZ		2130R03S11 AO OWERWIEW	ESAN Çine ÜYS 1.Faz_Kurutma3	+	A2.B3
							Next page:	22
							Previous page:	20

-R03S12
&EFS1/ 25.9

HONEYWELL

-X10:1
01

-X10:19
17

-X10:2
02

-X10:20
18

-X10:3
03

-X10:21
19

-X10:4
04

-X10:22
20

-X10:5
05

-X10:23
21

-X10:6
06

-X10:24
22

-X10:7
07

-X10:25
23

-X10:8
08

-X10:26
24

-X10:9
09

-X10:27
25

-X10:10
10

-X10:28
26

-X10:11
11

-X10:29
27

-X10:12
12

-X10:30
28

-X10:13
13

-X10:31
29

-X10:14
14

-X10:32
30

-X10:15
15

-X10:33
31

-X10:16
16



-X10:34
32

-X10:17
17

-X10:35
33

-X10:18
18

-X10:36
34

Çizen (Drawing)	Kontrol (Control)		Kontrol (Control)		Sayfa açıklaması (Page description)	Proje adı (Project name)	=	GB1
Necip SERT Proje Tasarım	Elc. / Eln. Eng. Mehmet CAN EMO Number : 34502		Proje Sorumlusu Yağmur KEPEZ		2130R03S12	ESAN Çine ÜYS 1.Faz_Kurutma3	+	A2.B3
							Next page:	31
							Previous page:	21

-R04S01
&EFS1/ 26.1

HONEYWELL

-X10:1
01

-X10:19
17

-X10:2
02

-X10:20
18

-X10:3
03

-X10:21
19

-X10:4
04

-X10:22
20

-X10:5
05

-X10:23
21

-X10:6
06

-X10:24
22

-X10:7
07

-X10:25
23

-X10:8
08

-X10:26
24

-X10:9
09

-X10:27
25

-X10:10
10

-X10:28
26

-X10:11
11

-X10:29
27

-X10:12
12

-X10:30
28

-X10:13
13

-X10:31
29

-X10:14
14

-X10:32
30

-X10:15
15

-X10:33
31

-X10:16
16



-X10:34
32

-X10:17
17

-X10:35
33

-X10:18
18

-X10:36
34

Çizen (Drawing)	Kontrol (Control)		Kontrol (Control)		Sayfa açıklaması (Page description)	Proje adı (Project name)	=	GB1
Necip SERT Proje Tasarım	Elc. / Eln. Eng. Mehmet CAN EMO Number : 34502		Proje Sorumlusu Yağmur KEPEZ		2130R04S01	ESAN Çine ÜYS 1.Faz_Kurutma3	+	A2.B3
							Next page:	32
							Previous page:	22

-R04S02
&EFS1/ 26.2

HONEYWELL

-X10:1
01

-X10:19
17

-X10:2
02

-X10:20
18

-X10:3
03

-X10:21
19

-X10:4
04

-X10:22
20

-X10:5
05

-X10:23
21

-X10:6
06

-X10:24
22

-X10:7
07

-X10:25
23

-X10:8
08

-X10:26
24

-X10:9
09

-X10:27
25

-X10:10
10

-X10:28
26

-X10:11
11

-X10:29
27

-X10:12
12

-X10:30
28

-X10:13
13

-X10:31
29

-X10:14
14

-X10:32
30

-X10:15
15

-X10:33
31

-X10:16
16



-X10:34
32

-X10:17
17

-X10:35
33

-X10:18
18

-X10:36
34

Çizen (Drawing)	Kontrol (Control)		Kontrol (Control)		Sayfa açıklaması (Page description)	Proje adı (Project name)	=	GB1
Necip SERT Proje Tasarım	Elc. / Eln. Eng. Mehmet CAN EMO Number : 34502		Proje Sorumlusu Yağmur KEPEZ		2130R04S02	ESAN Çine ÜYS 1.Faz_Kurutma3	+	A2.B3
							Next page:	33
							Previous page:	31

-R04S03
&EFS1/ 26.3

HONEYWELL

-X10:1
01

-X10:19
17

-X10:2
02

-X10:20
18

-X10:3
03

-X10:21
19

-X10:4
04

-X10:22
20

-X10:5
05

-X10:23
21

-X10:6
06

-X10:24
22

-X10:7
07

-X10:25
23

-X10:8
08

-X10:26
24

-X10:9
09

-X10:27
25

-X10:10
10

-X10:28
26

-X10:11
11

-X10:29
27

-X10:12
12

-X10:30
28

-X10:13
13

-X10:31
29

-X10:14
14

-X10:32
30

-X10:15
15

-X10:33
31

-X10:16
16



-X10:34
32

-X10:17
17

-X10:35
33

-X10:18
18

-X10:36
34

Çizen (Drawing)	Kontrol (Control)		Kontrol (Control)		Sayfa açıklaması (Page description)	Proje adı (Project name)	=	GB1
Necip SERT Proje Tasarım	Elc. / Eln. Eng. Mehmet CAN EMO Number : 34502		Proje Sorumlusu Yağmur KEPEZ		2130R04S03	ESAN Çine ÜYS 1.Faz_Kurutma3	+	A2.B3
							Next page:	34
							Previous page:	32

-R04S04
&EFS1/ 26.3

HONEYWELL

-X10:1
01

-X10:19
17

-X10:2
02

-X10:20
18

-X10:3
03

-X10:21
19

-X10:4
04

-X10:22
20

-X10:5
05

-X10:23
21

-X10:6
06

-X10:24
22

-X10:7
07

-X10:25
23

-X10:8
08

-X10:26
24

-X10:9
09

-X10:27
25

-X10:10
10

-X10:28
26

-X10:11
11

-X10:29
27

-X10:12
12

-X10:30
28

-X10:13
13

-X10:31
29

-X10:14
14

-X10:32
30

-X10:15
15

-X10:33
31

-X10:16
16



-X10:34
32

-X10:17
17

-X10:35
33

-X10:18
18

-X10:36
34

Çizen (Drawing)	Kontrol (Control)		Kontrol (Control)		Sayfa açıklaması (Page description)	Proje adı (Project name)	=	GB1
Necip SERT Proje Tasarım	Elc. / Eln. Eng. Mehmet CAN EMO Number : 34502		Proje Sorumlusu Yağmur KEPEZ		2130R04S04	ESAN Çine ÜYS 1.Faz_Kurutma3	+	A2.B3
							Next page:	35
							Previous page:	33

-R04S05
&EFS1/ 26.4

HONEYWELL

-X10:1
01

-X10:19
17

-X10:2
02

-X10:20
18

-X10:3
03

-X10:21
19

-X10:4
04

-X10:22
20

-X10:5
05

-X10:23
21

-X10:6
06

-X10:24
22

-X10:7
07

-X10:25
23

-X10:8
08

-X10:26
24

-X10:9
09

-X10:27
25

-X10:10
10

-X10:28
26

-X10:11
11

-X10:29
27

-X10:12
12

-X10:30
28

-X10:13
13

-X10:31
29

-X10:14
14

-X10:32
30

-X10:15
15

-X10:33
31

-X10:16
16



-X10:34
32

-X10:17
17

-X10:35
33

-X10:18
18

-X10:36
34

Çizen (Drawing)	Kontrol (Control)		Kontrol (Control)		Sayfa açıklaması (Page description)	Proje adı (Project name)	=	GB1
Necip SERT Proje Tasarım	Elc. / Eln. Eng. Mehmet CAN EMO Number : 34502		Proje Sorumlusu Yağmur KEPEZ		2130R04S05	ESAN Çine ÜYS 1.Faz_Kurutma3	+	AZ.B3
							Next page:	36
							Previous page:	34

-R04S06
&EFS1/ 26.5

HONEYWELL

-X10:1
01

-X10:19
17

-X10:2
02

-X10:20
18

-X10:3
03

-X10:21
19

-X10:4
04

-X10:22
20

-X10:5
05

-X10:23
21

-X10:6
06

-X10:24
22

-X10:7
07

-X10:25
23

-X10:8
08

-X10:26
24

-X10:9
09

-X10:27
25

-X10:10
10

-X10:28
26

-X10:11
11

-X10:29
27

-X10:12
12

-X10:30
28

-X10:13
13

-X10:31
29

-X10:14
14

-X10:32
30

-X10:15
15

-X10:33
31

-X10:16
16



-X10:34
32

-X10:17
17

-X10:35
33

-X10:18
18

-X10:36
34

Çizen (Drawing)	Kontrol (Control)		Kontrol (Control)		Sayfa açıklaması (Page description) 2130R04S06	Proje adı (Project name) ESAN Çine ÜYS 1.Faz_Kurutma3	=	GB1
Necip SERT Proje Tasarım	Elc. / Eln. Eng. Mehmet CAN EMO Number : 34502		Proje Sorumlusu Yağmur KEPEZ				+	A2.B3
							Next page:	37
							Previous page:	35

-R04S07
&EFS1/ 26.5

HONEYWELL

-X10:1
01

-X10:19
17

-X10:2
02

-X10:20
18

-X10:3
03

-X10:21
19

-X10:4
04

-X10:22
20

-X10:5
05

-X10:23
21

-X10:6
06

-X10:24
22

-X10:7
07

-X10:25
23

-X10:8
08

-X10:26
24

-X10:9
09

-X10:27
25

-X10:10
10

-X10:28
26

-X10:11
11

-X10:29
27

-X10:12
12

-X10:30
28

-X10:13
13

-X10:31
29

-X10:14
14

-X10:32
30

-X10:15
15

-X10:33
31

-X10:16
16



-X10:34
32

-X10:17
17

-X10:35
33

-X10:18
18

-X10:36
34

Çizen (Drawing)	Kontrol (Control)		Kontrol (Control)		Sayfa açıklaması (Page description)	Proje adı (Project name)	=	GB1
Necip SERT Proje Tasarım	Elc. / Eln. Eng. Mehmet CAN EMO Number : 34502		Proje Sorumlusu Yağmur KEPEZ		2130R04S07	ESAN Çine ÜYS 1.Faz_Kurutma3	+	A2.B3
							Next page:	38
							Previous page:	36

-R04S08
&EFS1/ 26.6

HONEYWELL

-X10:1
01

-X10:2
02

-X10:3
03

-X10:4
04

-X10:5
05

-X10:6
06

-X10:7
07

-X10:8
08

-X10:9
09

-X10:10
10

-X10:11
11

-X10:12
12

-X10:13
13

-X10:14
14

-X10:15
15

-X10:16
16

-X10:17
17

-X10:18
18

-X10:19
17

-X10:20
18

-X10:21
19

-X10:22
20

-X10:23
21

-X10:24
22

-X10:25
23

-X10:26
24

-X10:27
25

-X10:28
26

-X10:29
27

-X10:30
28

-X10:31
29



-X10:32
30

-X10:33
31

-X10:34
32

-X10:35
33

-X10:36
34

Çizen (Drawing)	Kontrol (Control)		Kontrol (Control)		Sayfa açıklaması (Page description) 2130R04S08	Proje adı (Project name) ESAN Çine ÜYS 1.Faz_Kurutma3	=	GB1
Necip SERT Proje Tasarım	Elc. / Eln. Eng. Mehmet CAN EMO Number : 34502		Proje Sorumlusu Yağmur KEPEZ				+	A2.B3
							Next page:	39
							Previous page:	37

-R04S09
&EFS1/ 26.7

HONEYWELL

-X10:1
01

-X10:19
17

-X10:2
02

-X10:20
18

-X10:3
03

-X10:21
19

-X10:4
04

-X10:22
20

-X10:5
05

-X10:23
21

-X10:6
06

-X10:24
22

-X10:7
07

-X10:25
23

-X10:8
08

-X10:26
24

-X10:9
09

-X10:27
25

-X10:10
10

-X10:28
26

-X10:11
11

-X10:29
27

-X10:12
12

-X10:30
28

-X10:13
13

-X10:31
29

-X10:14
14

-X10:32
30

-X10:15
15

-X10:33
31

-X10:16
16



-X10:34
32

-X10:17
17

-X10:35
33

-X10:18
18

-X10:36
34

Çizen (Drawing)	Kontrol (Control)		Kontrol (Control)		Sayfa açıklaması (Page description)	Proje adı (Project name)	=	GB1
Necip SERT Proje Tasarım	Elc. / Eln. Eng. Mehmet CAN EMO Number : 34502		Proje Sorumlusu Yağmur KEPEZ		2130R04S09	ESAN Çine ÜYS 1.Faz_Kurutma3	+	AZ.B3
							Next page:	40
							Previous page:	38

-R04S10
&EFS1/ 26.7

HONEYWELL

-X10:1
01

-X10:19
17

-X10:2
02

-X10:20
18

-X10:3
03

-X10:21
19

-X10:4
04

-X10:22
20

-X10:5
05

-X10:23
21

-X10:6
06

-X10:24
22

-X10:7
07

-X10:25
23

-X10:8
08

-X10:26
24

-X10:9
09

-X10:27
25

-X10:10
10

-X10:28
26

-X10:11
11

-X10:29
27

-X10:12
12

-X10:30
28

-X10:13
13

-X10:31
29

-X10:14
14

-X10:32
30

-X10:15
15

-X10:33
31

-X10:16
16



-X10:34
32

-X10:17
17

-X10:35
33

-X10:18
18

-X10:36
34

Çizen (Drawing)	Kontrol (Control)		Kontrol (Control)		Sayfa açıklaması (Page description)	Proje adı (Project name)	=	GB1
Necip SERT Proje Tasarım	Elc. / Eln. Eng. Mehmet CAN EMO Number : 34502		Proje Sorumlusu Yağmur KEPEZ		2130R04S10	ESAN Çine ÜYS 1.Faz_Kurutma3	+	AZ.B3
							Next page:	41
							Previous page:	39

-R04S11
&EFS1/ 26.8

HONEYWELL

-X10:1
01

-X10:2
02

-X10:3
03

-X10:4
04

-X10:5
05

-X10:6
06

-X10:7
07

-X10:8
08

-X10:9
09

-X10:10
10

-X10:11
11

-X10:12
12

-X10:13
13

-X10:14
14

-X10:15
15

-X10:16
16

-X10:17
17

-X10:18
18

-X10:19
17

-X10:20
18

-X10:21
19

-X10:22
20

-X10:23
21

-X10:24
22

-X10:25
23

-X10:26
24

-X10:27
25

-X10:28
26

-X10:29
27

-X10:30
28

-X10:31
29



-X10:32
30

-X10:33
31

-X10:34
32

-X10:35
33

-X10:36
34

Çizen (Drawing)	Kontrol (Control)		Kontrol (Control)		Sayfa açıklaması (Page description)	Proje adı (Project name)	=	GB1
Necip SERT Proje Tasarım	Elc. / Eln. Eng. Mehmet CAN EMO Number : 34502		Proje Sorumlusu Yağmur KEPEZ		2130R04S11	ESAN Çine ÜYS 1.Faz_Kurutma3	+	AZ.B3
							Next page:	42
							Previous page:	40

-R04S12
&EFS1/ 26.9

HONEYWELL

-X10:1
01

-X10:19
17

-X10:2
02

-X10:20
18

-X10:3
03

-X10:21
19

-X10:4
04

-X10:22
20

-X10:5
05

-X10:23
21

-X10:6
06

-X10:24
22

-X10:7
07

-X10:25
23

-X10:8
08

-X10:26
24

-X10:9
09

-X10:27
25

-X10:10
10

-X10:28
26

-X10:11
11

-X10:29
27

-X10:12
12

-X10:30
28

-X10:13
13

-X10:31
29

-X10:14
14

-X10:32
30

-X10:15
15

-X10:33
31

-X10:16
16



-X10:34
32

-X10:17
17

-X10:35
33

-X10:18
18

-X10:36
34

Çizen (Drawing)	Kontrol (Control)		Kontrol (Control)		Sayfa açıklaması (Page description)	Proje adı (Project name)	=	GB1
Necip SERT Proje Tasarım	Elc. / Eln. Eng. Mehmet CAN EMO Number : 34502		Proje Sorumlusu Yağmur KEPEZ		2130R04S12	ESAN Çine ÜYS 1.Faz_Kurutma3	+	A2,B3
							Next page:	&EFS1/1
					Previous page:	41		

Honeywell

Honeywell Teknoloji A.Ş.
www.honeywell.com

ESAN Çine ÜYS 1.Faz_Kurutma3

KURUTMA 3

= GB1

2130UOC01

+ A2.B3

DCS

+ EFS1

Devre şeması Elektrik tekniği

Çizen (Drawing) Necip SERT Proje Tasarım	Kontrol (Control) Elc. / Eln. Eng. Mehmet CAN EMO Number : 34502		Kontrol (Control) Proje Sorumlusu Yağmur KEPEZ		Sayfa açıklaması (Page description) Açıklama Sayfası KURUTMA 3	Proje adı (Project name) ESAN Çine ÜYS 1.Faz_Kurutma3	= GB1 + A2.B3 Next page: 11 Previous page: &EFA1/42
--	--	---	--	---	--	--	--

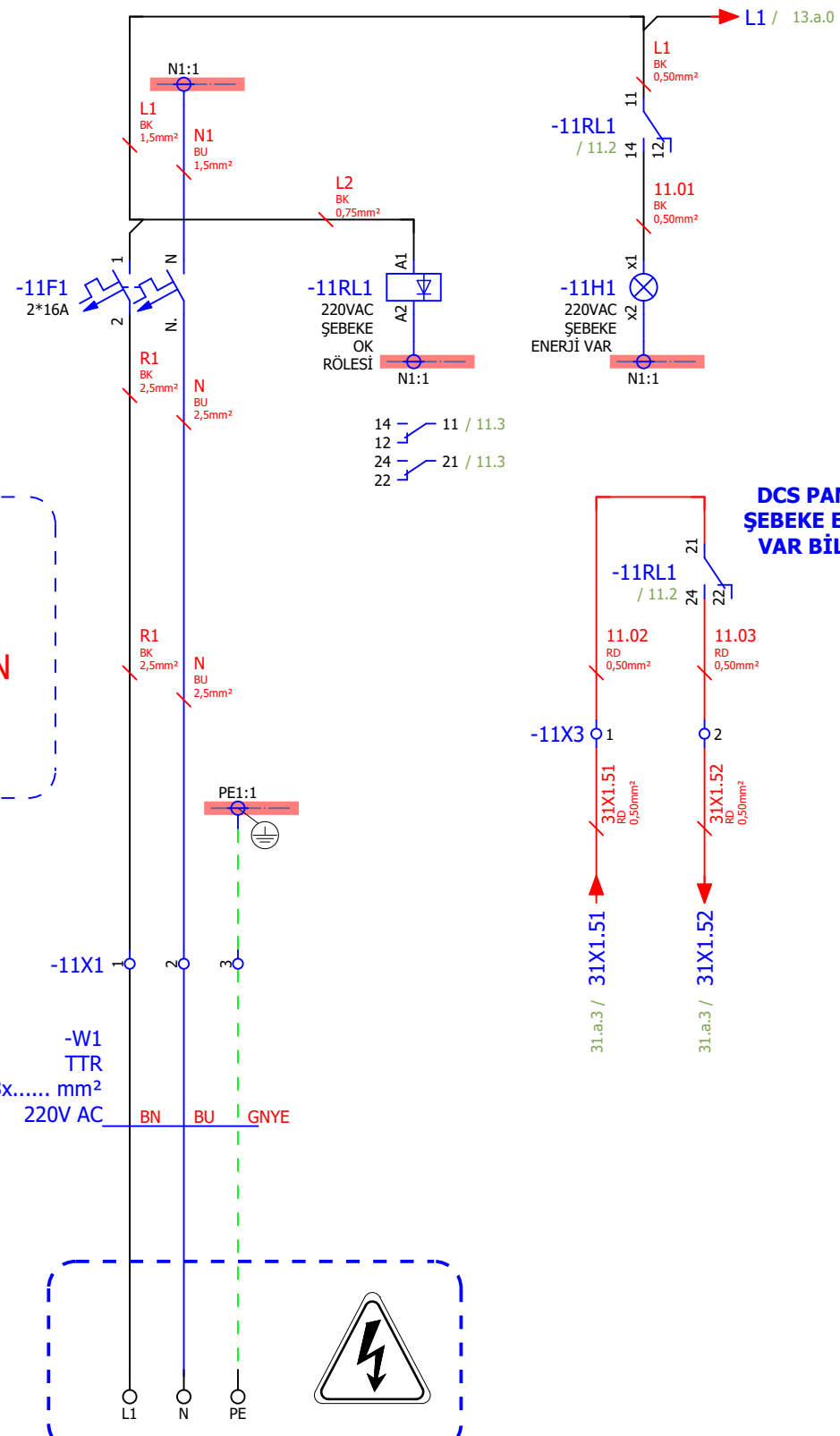

DİKKAT
ŞALTER KAPALI İKEN ENERJİ VAR..

220 VAC
50 Hz

ŞEBEKE BESLEME

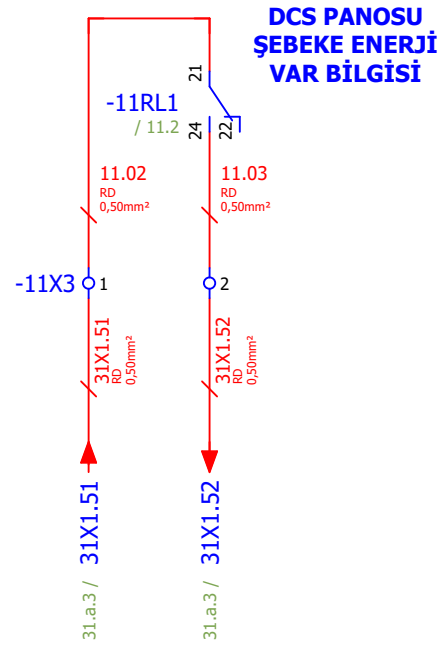

DİKKAT
ŞALTER KAPALI İKEN ENERJİ VAR..

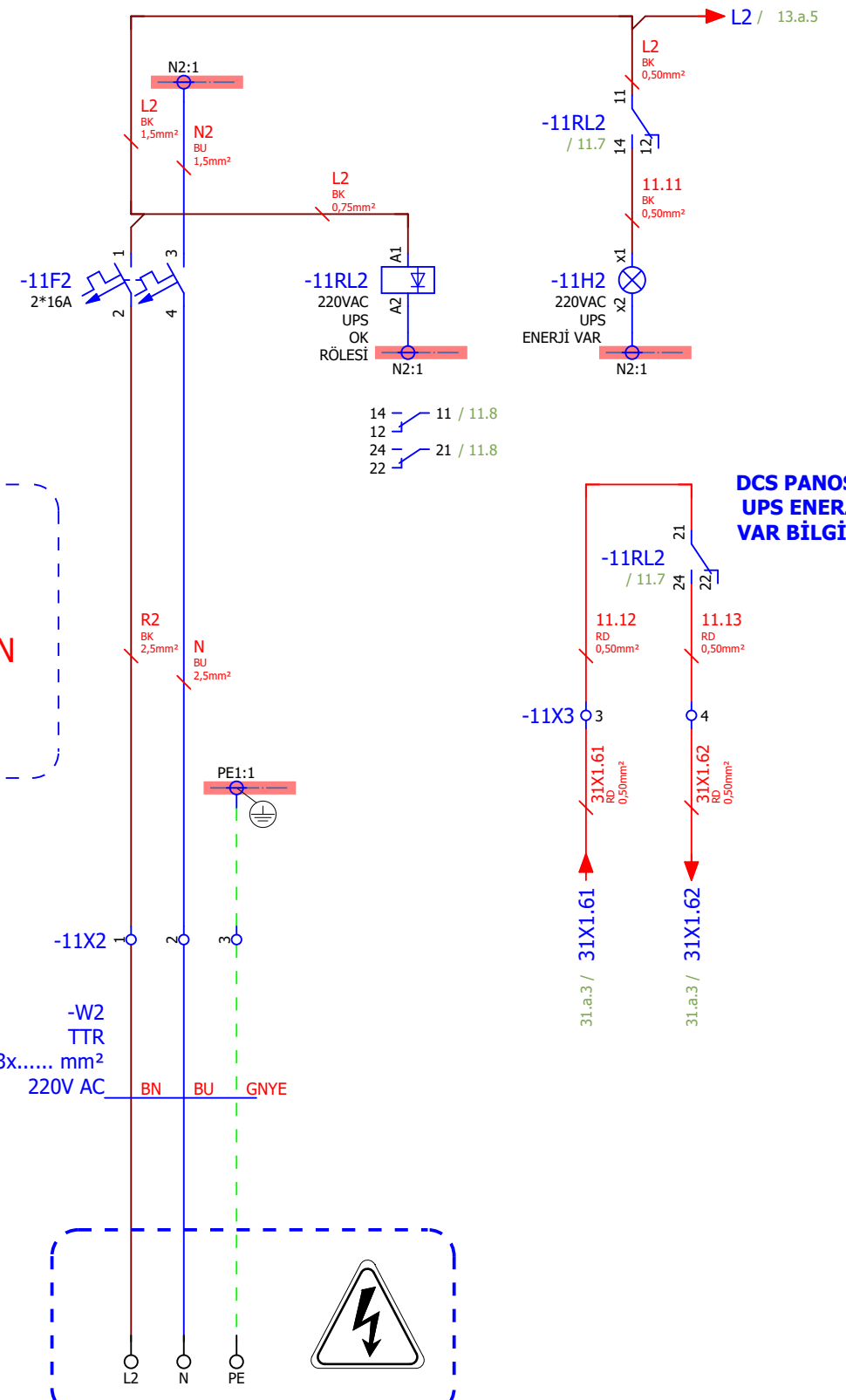

220 VAC
50 Hz

UPS BESLEME

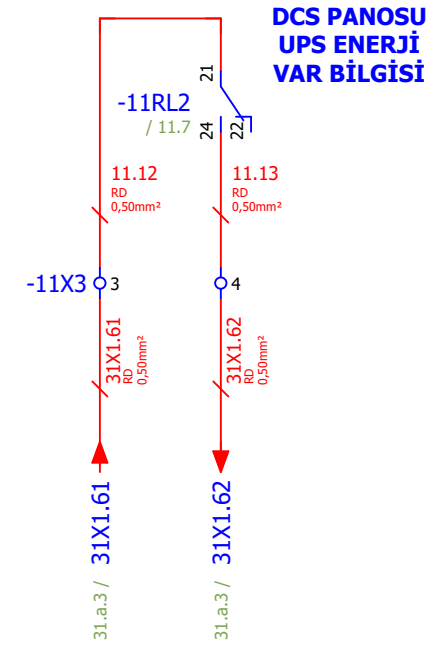

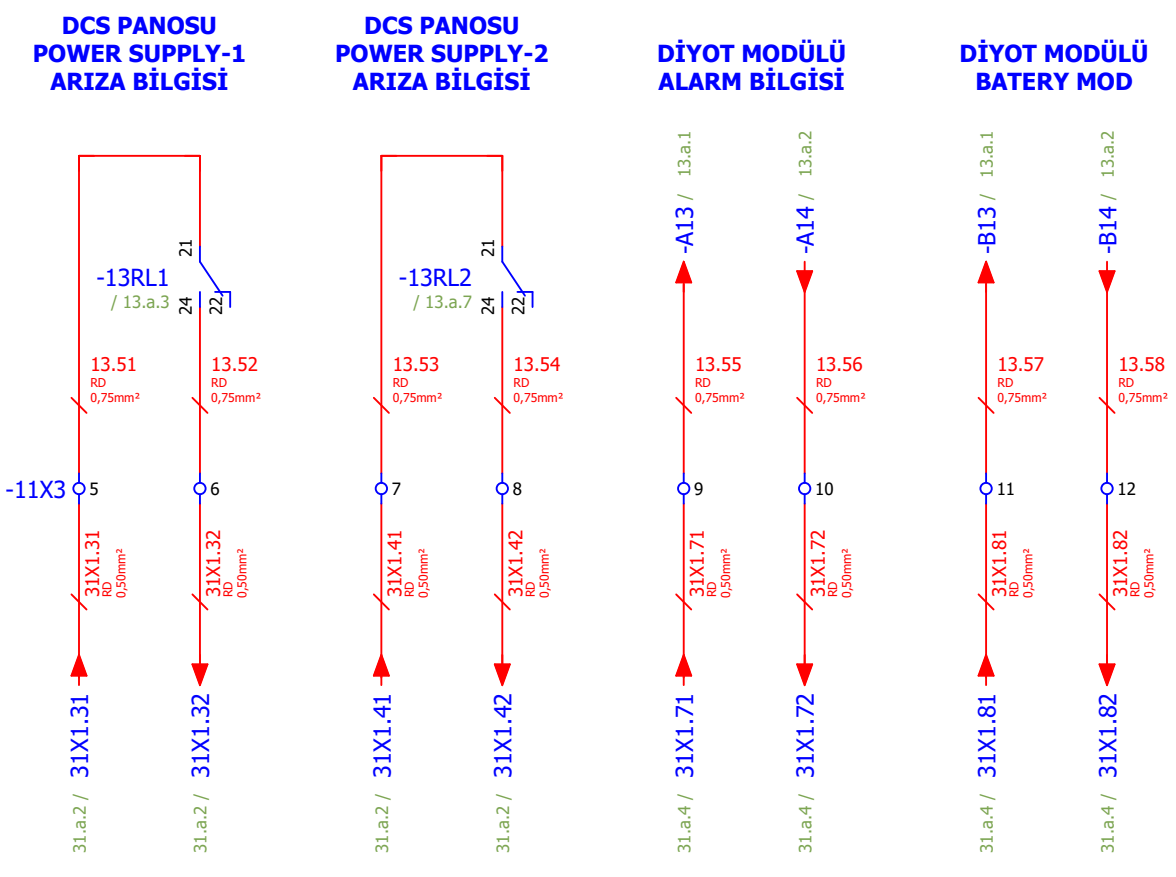
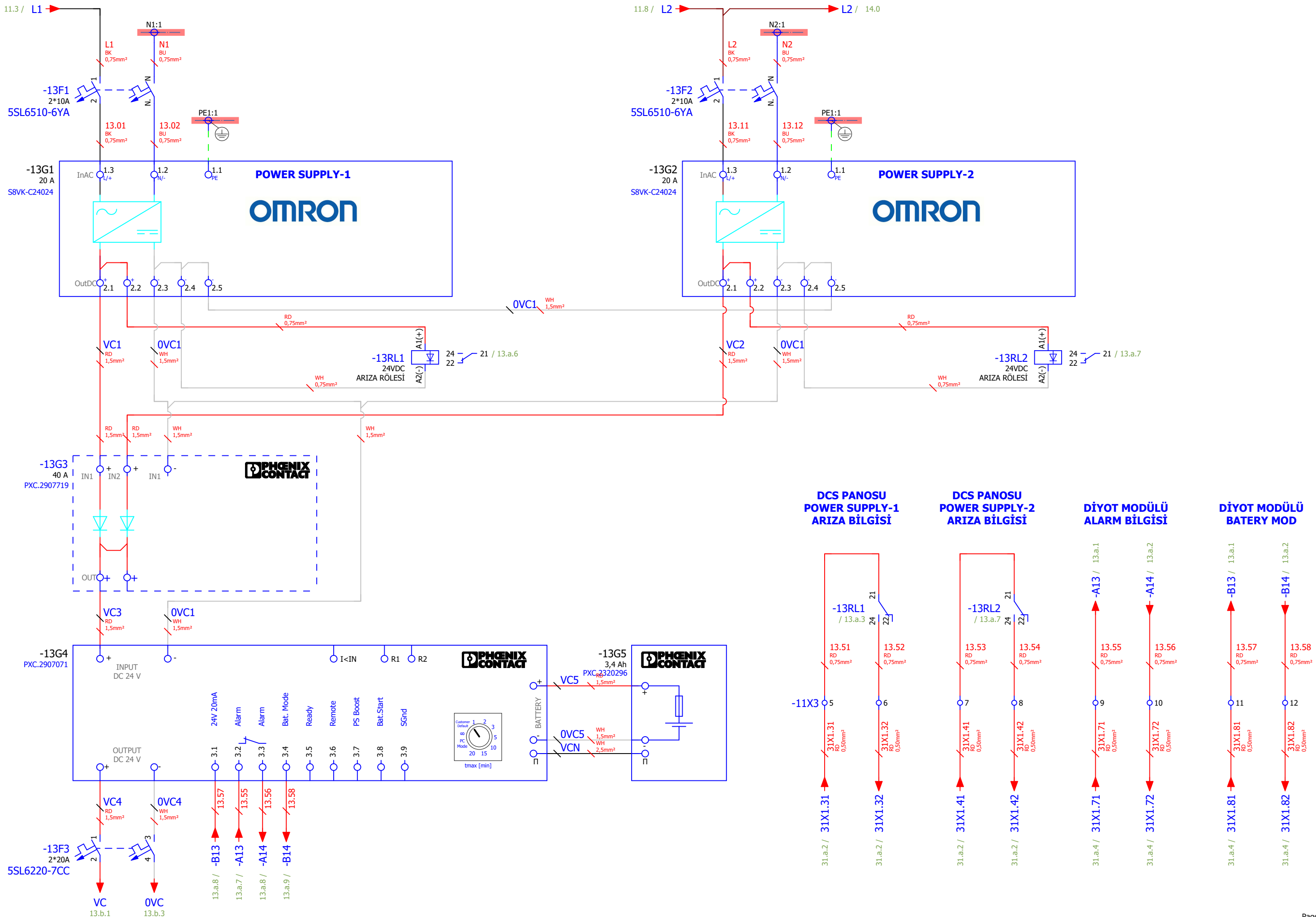

Çizen (Drawing) Necip SERT Proje Tasarım	Kontrol (Control) Elc. / Eln. Eng. Mehmet CAN EMO Number : 34502	ARKPAN imagineering solutions	Kontrol (Control) Proje Sorumlusu Yağmur KEPEZ	Honeywell	Sayfa açıklaması (Page description) Güç Kaynağı - 1	Proje adı (Project name) ESAN Çine ÜYS 1.Faz_Kurutma3	= + Next page: Previous page:	GB1 A2.B3 13.b 11
--	--	----------------------------------	--	-----------	--	--	--	----------------------------

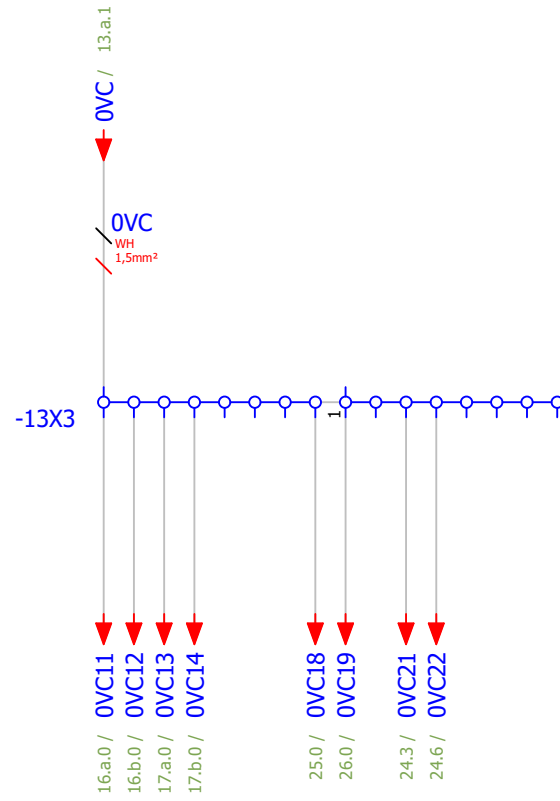
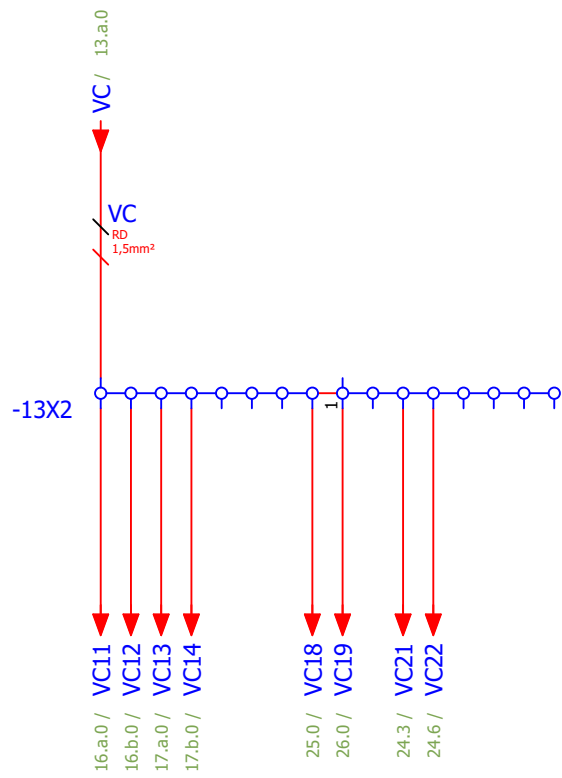

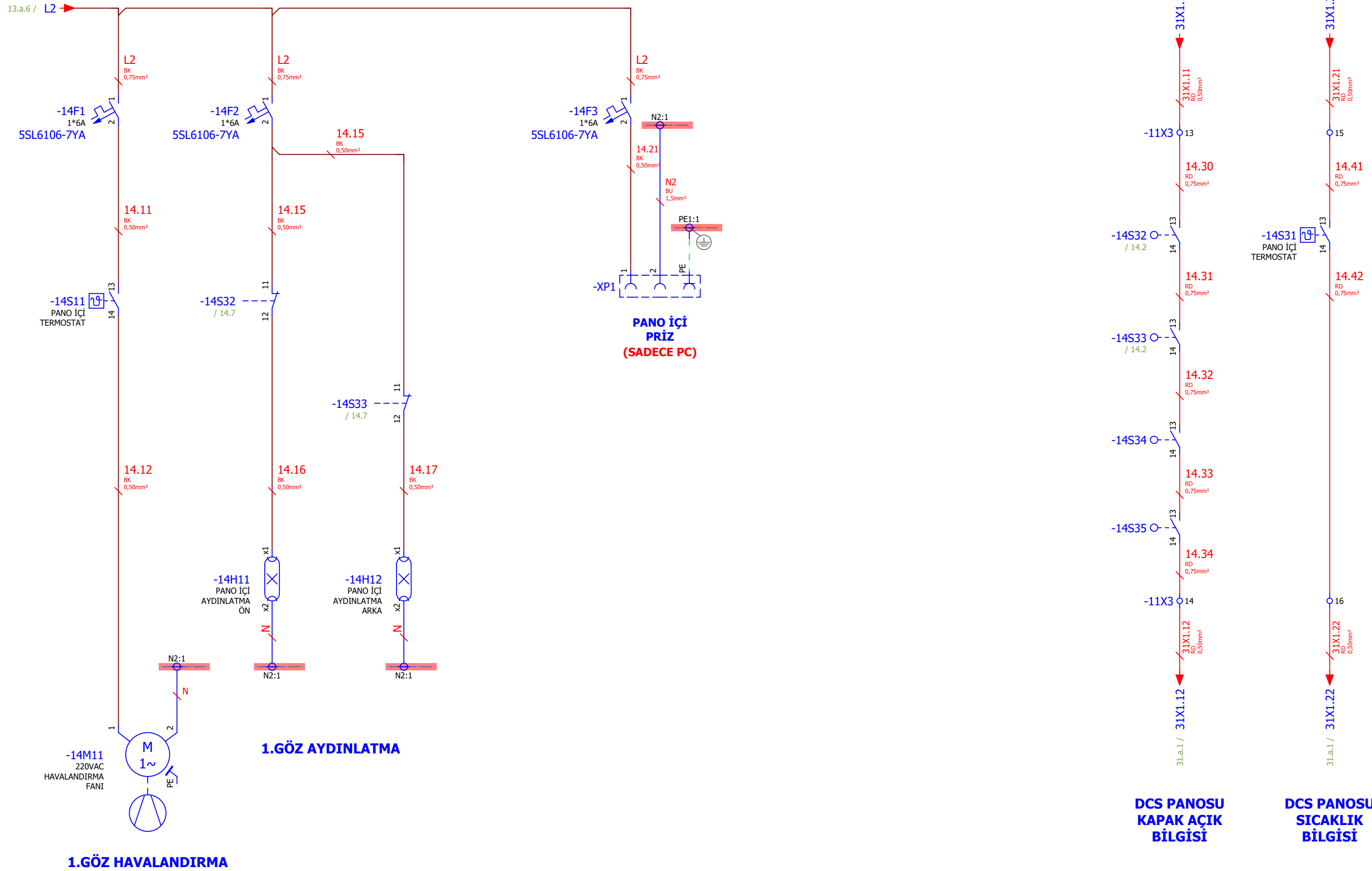

Çizen (Drawing)	Kontrol (Control)		Kontrol (Control)		Sayfa açıklaması (Page description)	Proje adı (Project name)	=	GB1
Necip SERT Proje Tasarım	Elc. / Eln. Eng. Mehmet CAN EMO Number : 34502		Proje Sorumlusu Yağmur KEPEZ		Güç Kaynağı - 2	ESAN Çine ÜYS 1.Faz_Kurutma3	+	A2,B3
							Next page:	14
							Previous page:	13.a



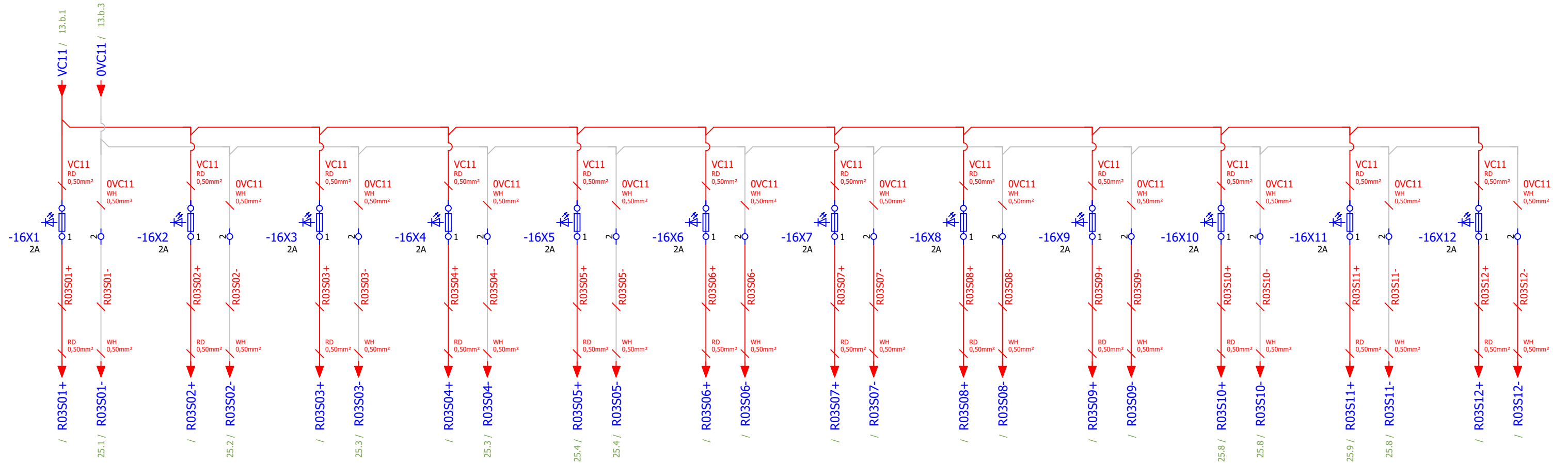

13.b

Çizen (Drawing) Necip SERT Proje Tasarım	Kontrol (Control) Elc. / Eln. Eng. Mehmet CAN EMO Number : 34502	ARKPAN imagineering solutions	Kontrol (Control) Proje Sorumlusu Yağmur KEPEZ	Honeywell	Sayfa açıklaması (Page description) Havalandırma Ve Aydınlatma-1	Proje adı (Project name) ESAN Çine ÜYS 1.Faz_Kurutma3	= + Next page: Previous page:	GB1 A2.B3 16.a 13.b
--	--	---	--	------------------	---	--	--	------------------------------



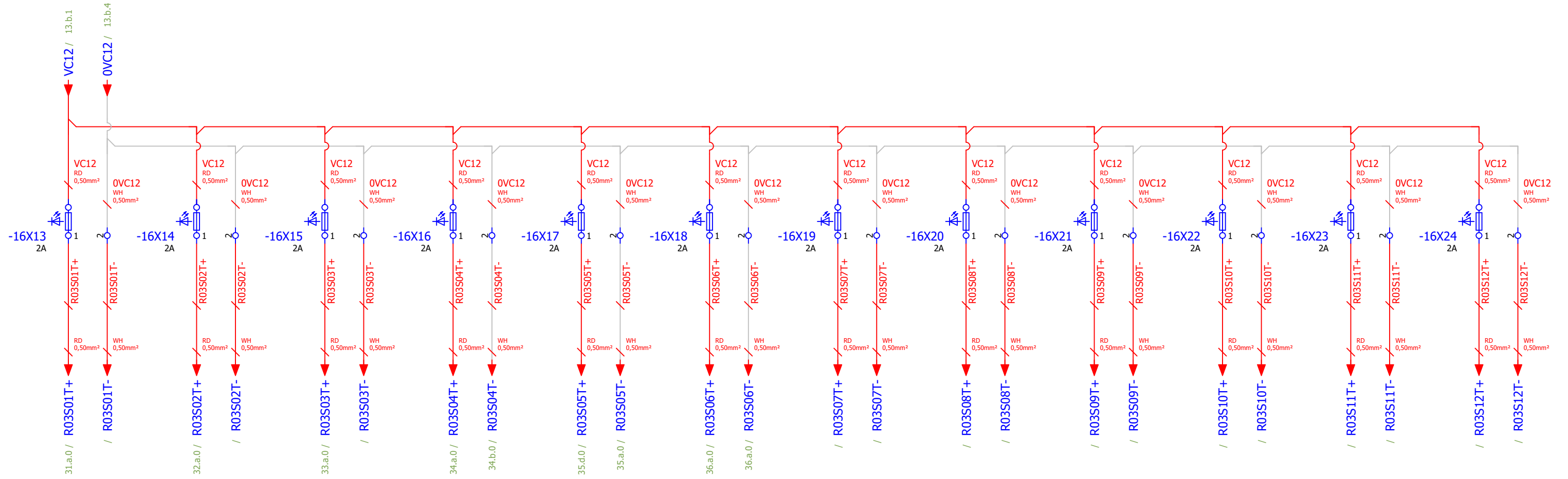

Çizen (Drawing) Necip SERT Proje Tasarım	Kontrol (Control) Elc. / Eln. Eng. Mehmet CAN EMO Number : 34502		Kontrol (Control) Proje Sorumlusu Yağmur KEPEZ		Sayfa açıklaması (Page description) RACK - 03 24VDC Modül Besleme Dağıtım	Proje adı (Project name) ESAN Çine ÜYS 1.Faz_Kurutma3	= GB1 + A2.B3 Next page: 16.b Previous page:
--	--	---	--	---	--	--	---



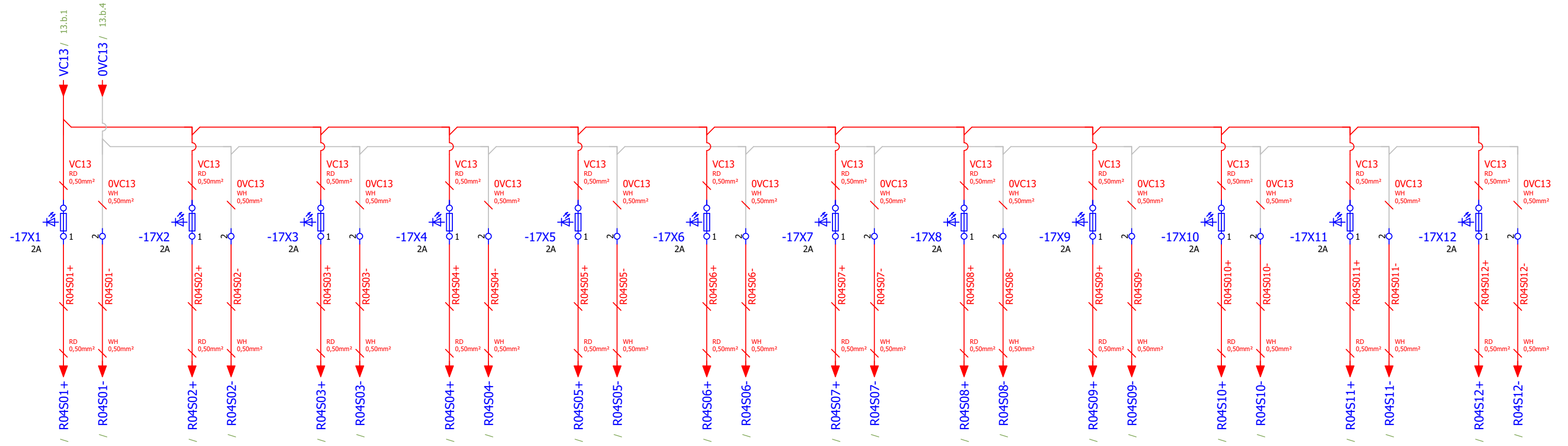

Çizen (Drawing) Necip SERT Proje Tasarım	Kontrol (Control) Elc. / Eln. Eng. Mehmet CAN EMO Number : 34502		Kontrol (Control) Proje Sorumlusu Yağmur KEPEZ		Sayfa açıklaması (Page description) RACK - 03 24VDC Terminal Besleme Dağıtım	Proje adı (Project name) ESAN Çine ÜYS 1.Faz_Kurutma3	= GB1 + A2.B3 Next page: 17.a Previous page: 16.a
--	--	---	--	---	---	--	--

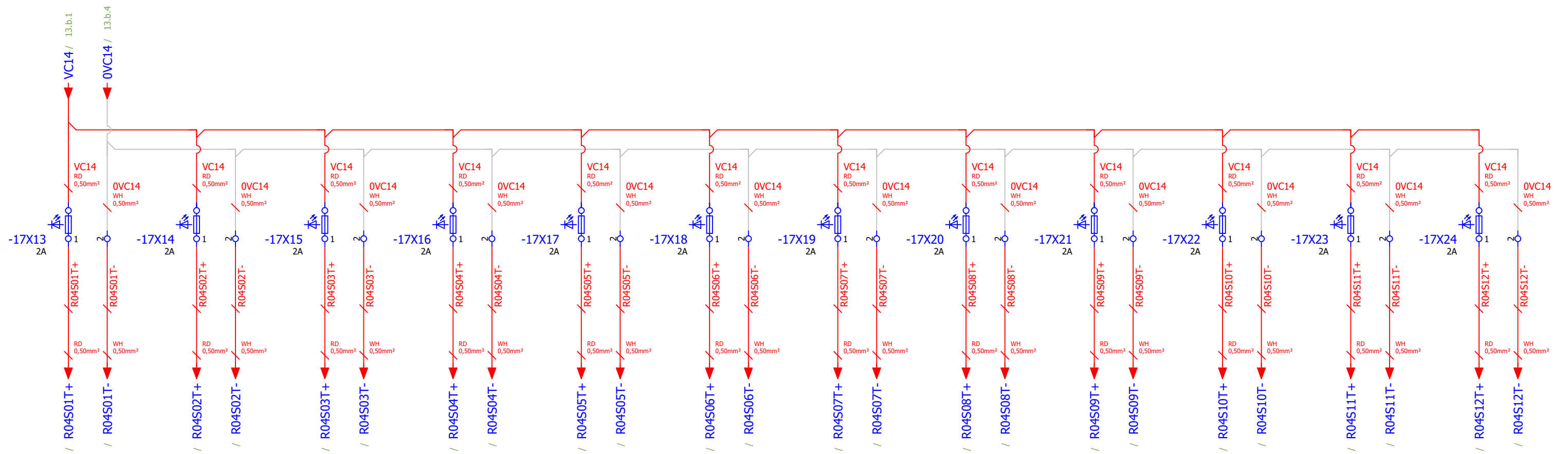

Çizen (Drawing) Necip SERT Proje Tasarım	Kontrol (Control) Elc. / Eln. Eng. Mehmet CAN EMO Number : 34502		Kontrol (Control) Proje Sorumlusu Yağmur KEPEZ		Sayfa açıklaması (Page description) RACK - 04 24VDC Modül Besleme Dağıtım	Proje adı (Project name) ESAN Çine ÜYS 1.Faz_Kurutma3	= + Next page: Previous page:	GB1 A2.B3 17.b 16.b
--	--	---	--	---	--	--	--	------------------------------



Çizen (Drawing) Necip SERT Proje Tasarım	Kontrol (Control) Elc. / Eln. Eng. Mehmet CAN EMO Number : 34502		Kontrol (Control) Proje Sorumlusu Yağmur KEPEZ		Sayfa açıklaması (Page description) RACK - 04 24VDC Terminal Besleme Dağıtım	Proje adı (Project name) ESAN Çine ÜYS 1.Faz_Kurutma3	= + Next page: Previous page:	GB1 A2.B3 23 17.a
--	--	---	--	---	---	--	--	----------------------------

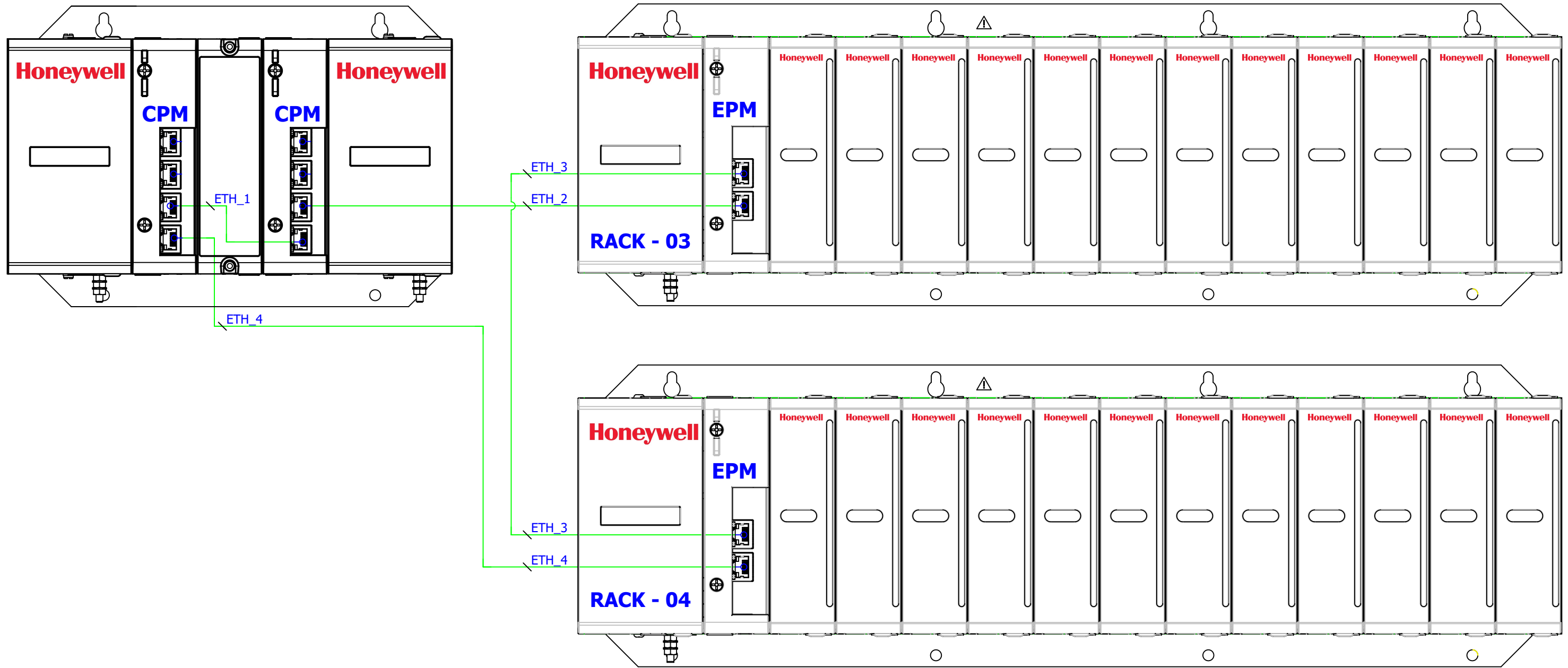

17.b

Çizen (Drawing) Necip SERT Proje Tasarım	Kontrol (Control) Elc. / Eln. Eng. Mehmet CAN EMO Number : 34502		Kontrol (Control) Proje Sorumlusu Yağmur KEPEZ		Sayfa açıklaması (Page description) Network Ağ Bağlantıları	Proje adı (Project name) ESAN Çine ÜYS 1.Faz_Kurutma3	= GB1 + A2.B3 Next page: 24 Previous page: 17.b
--	--	---	--	---	--	--	--

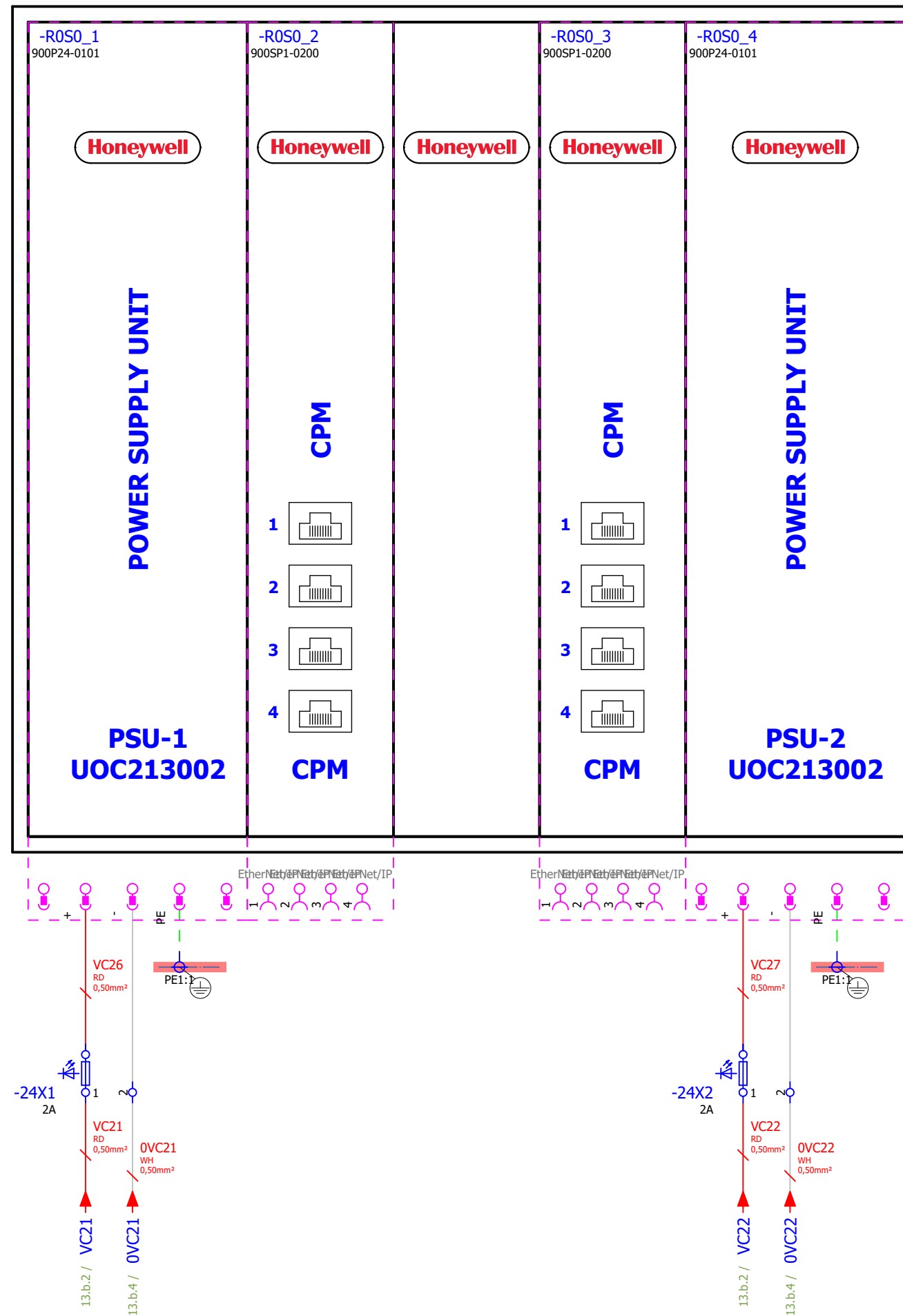

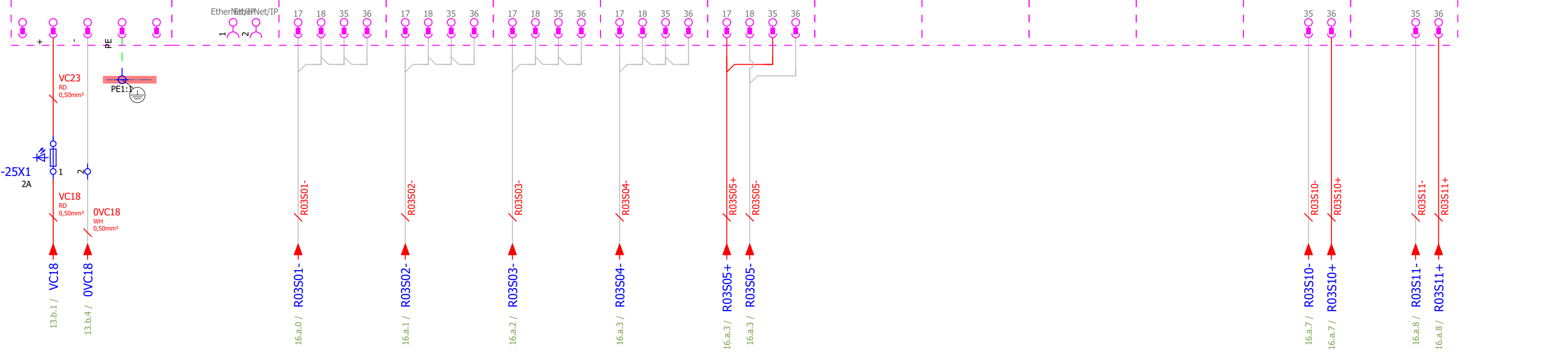
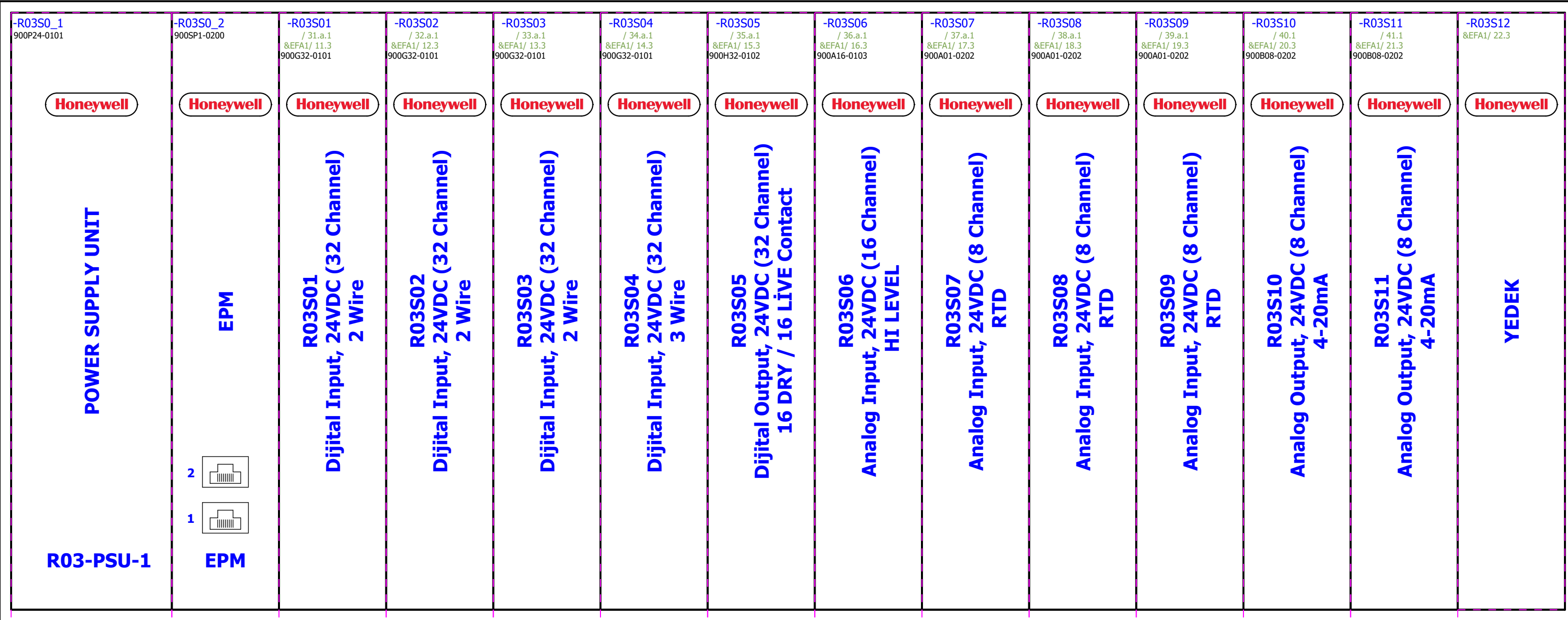

Çizen (Drawing)	Kontrol (Control)		Kontrol (Control)		Sayfa açıklaması (Page description)	Proje adı (Project name)	=	GB1
Necip SERT Proje Tasarım	Elc. / Eln. Eng. Mehmet CAN EMO Number : 34502		Proje Sorumlusu Yağmur KEPEZ		REDUNDANT CPU 24VDC Besleme	ESAN Çine ÜYS 1.Faz_Kurutma3	+	A2.B3
							Next page:	25
							Previous page:	23



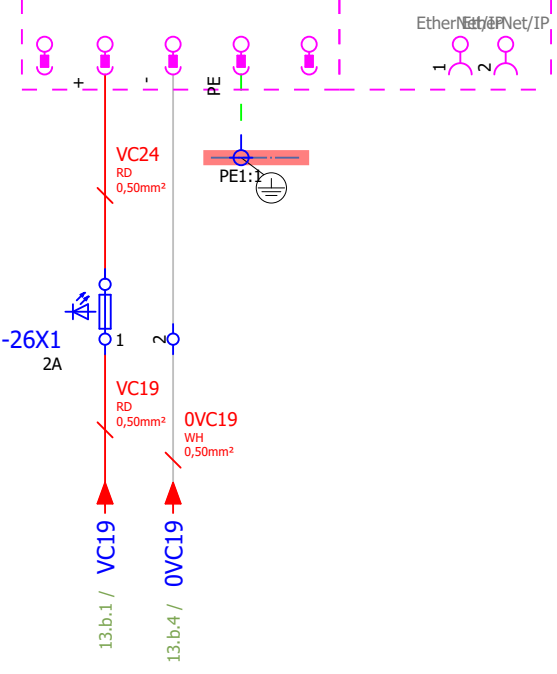
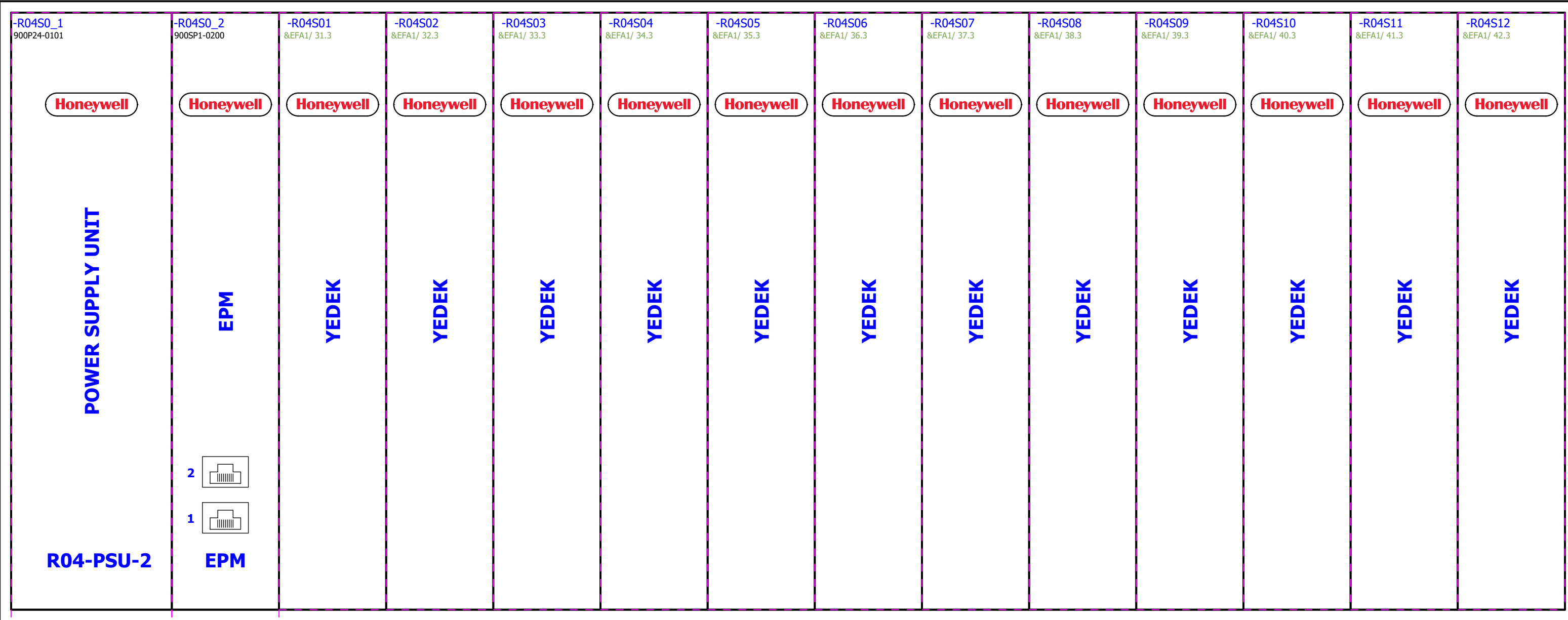

Çizen (Drawing) Necip SERT Proje Tasarım	Kontrol (Control) Elc. / Eln. Eng. Mehmet CAN EMO Number : 34502	ARKPAN imagineering solutions	Kontrol (Control) Proje Sorumlusu Yağmur KEPEZ	Honeywell	Sayfa açıklaması (Page description) RACK - 03 24VDC Modül Besleme	Proje adı (Project name) ESAN Çine ÜYS 1.Faz_Kurutma3	= GB1 + A2.B3 Next page: 26 Previous page: 24
--	--	----------------------------------	--	------------------	--	--	--



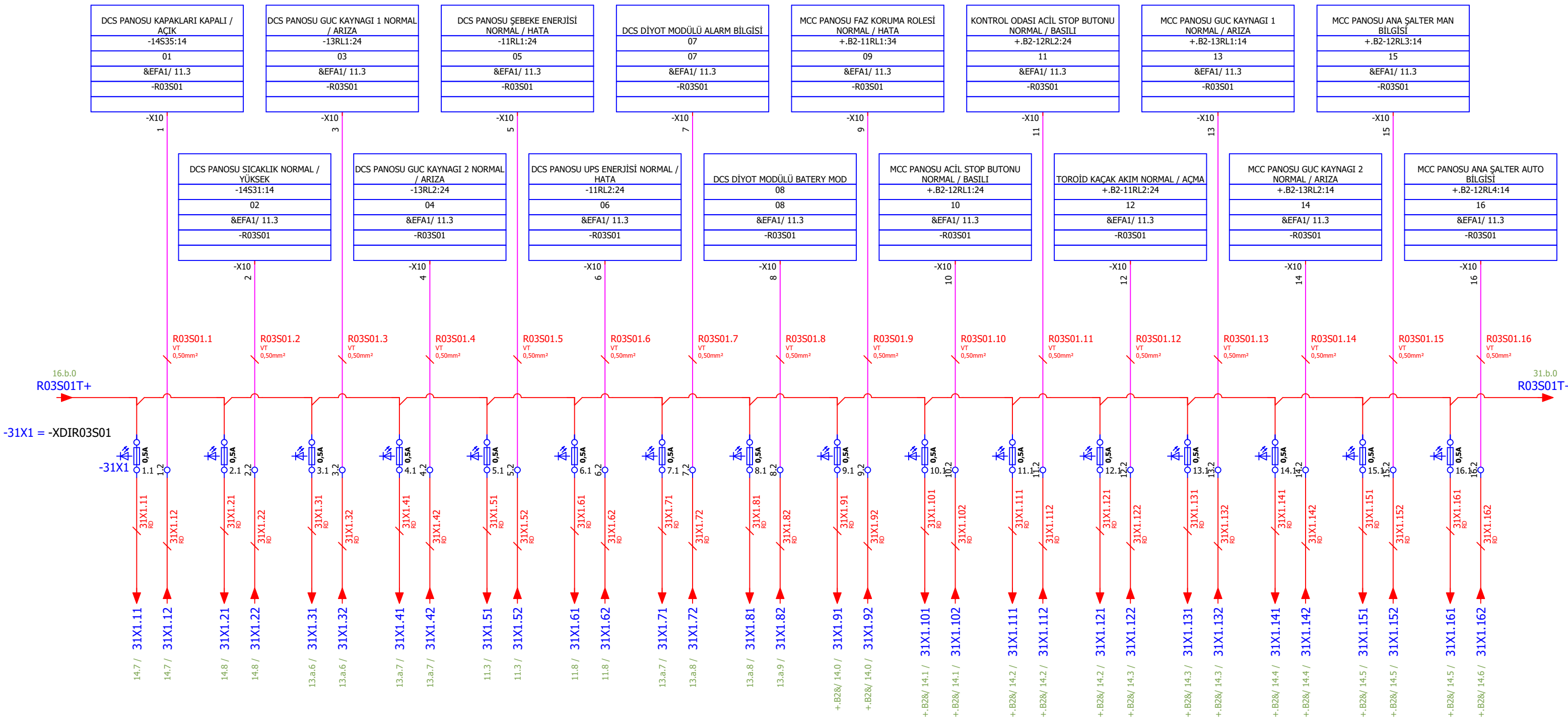

Çizen (Drawing) Necip SERT Proje Tasarım	Kontrol (Control) Elc. / Eln. Eng. Mehmet CAN EMO Number : 34502		Kontrol (Control) Proje Sorumlusu Yağmur KEPEZ		Sayfa açıklaması (Page description) RACK - 04 24VDC Modül Besleme	Proje adı (Project name) ESAN Çine ÜYS 1.Faz_Kurutma3	= + Next page: Previous page:	GB1 A2.B3 31.a 25
--	--	---	--	---	--	--	--	----------------------------



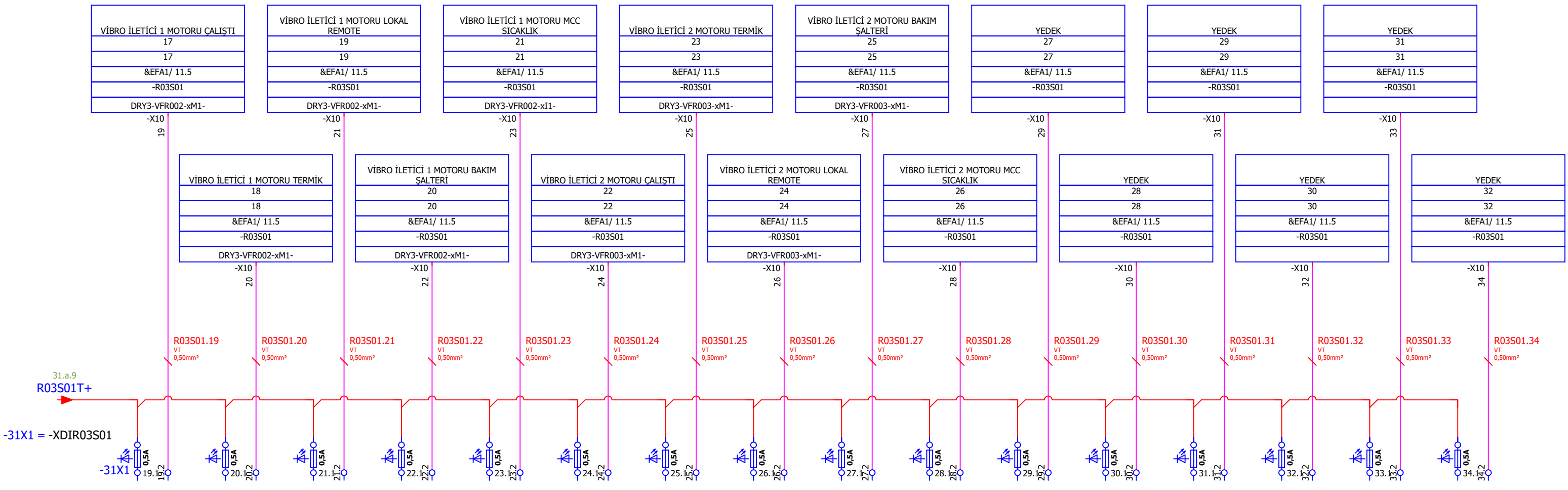

Çizen (Drawing) Necip SERT Proje Tasarım	Kontrol (Control) Elc. / Eln. Eng. Mehmet CAN EMO Number : 34502		Kontrol (Control) Proje Sorumlusu Yağmur KEPEZ		Sayfa açıklaması (Page description) RACK - 3 SLOT - 1 Digital Input (32 Channel) (1-16) 2 WIRE	Proje adı (Project name) ESAN Çine ÜYS 1.Faz_Kurutma3	= GB1 + A2.B3 Next page: 31.b Previous page:
--	--	---	--	---	---	--	---

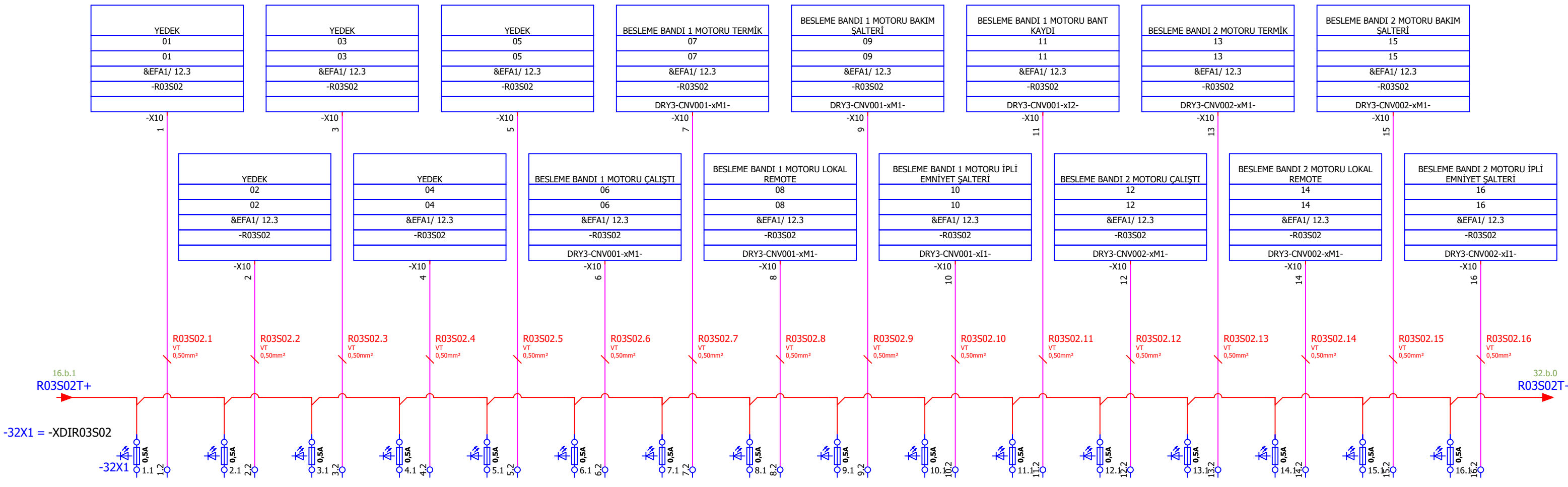

Çizen (Drawing)	Kontrol (Control)		Kontrol (Control)		Sayfa açıklaması (Page description)	Proje adı (Project name)	=	GB1
Necip SERT Proje Tasarım	Elc. / Eln. Eng. Mehmet CAN EMO Number : 34502		Proje Sorumlusu Yağmur KEPEZ		RACK - 3 SLOT - 1 Digital Input (32 Channel) (17-32) 2 WIRE	ESAN Çine ÜYS 1.Faz_Kurutma3	+	A2.B3
							Next page:	32.a
							Previous page:	31.a



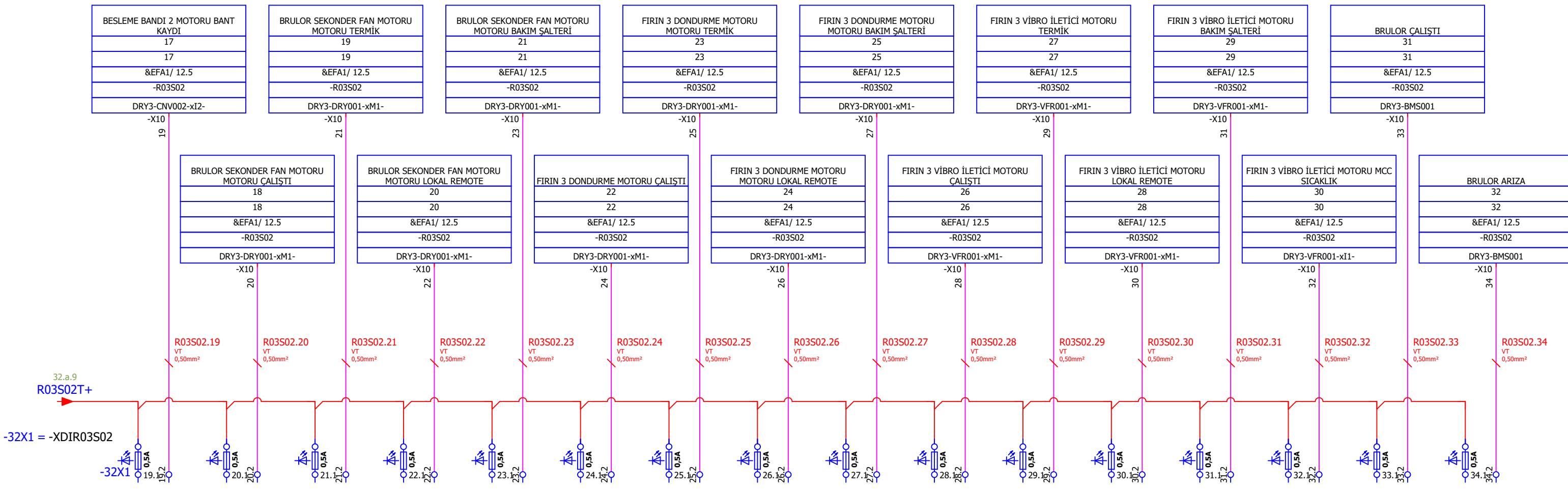

Çizen (Drawing) Necip SERT Proje Tasarım	Kontrol (Control) Elc. / Eln. Eng. Mehmet CAN EMO Number : 34502		Kontrol (Control) Proje Sorumlusu Yağmur KEPEZ		Sayfa açıklaması (Page description) RACK - 3 SLOT - 2 Digital Input (32 Channel) (1-16) 2 WIRE	Proje adı (Project name) ESAN Çine ÜYS 1.Faz_Kurutma3	= GB1 + A2.B3 Next page: 32.b Previous page: 31.b
--	--	---	--	---	---	--	--



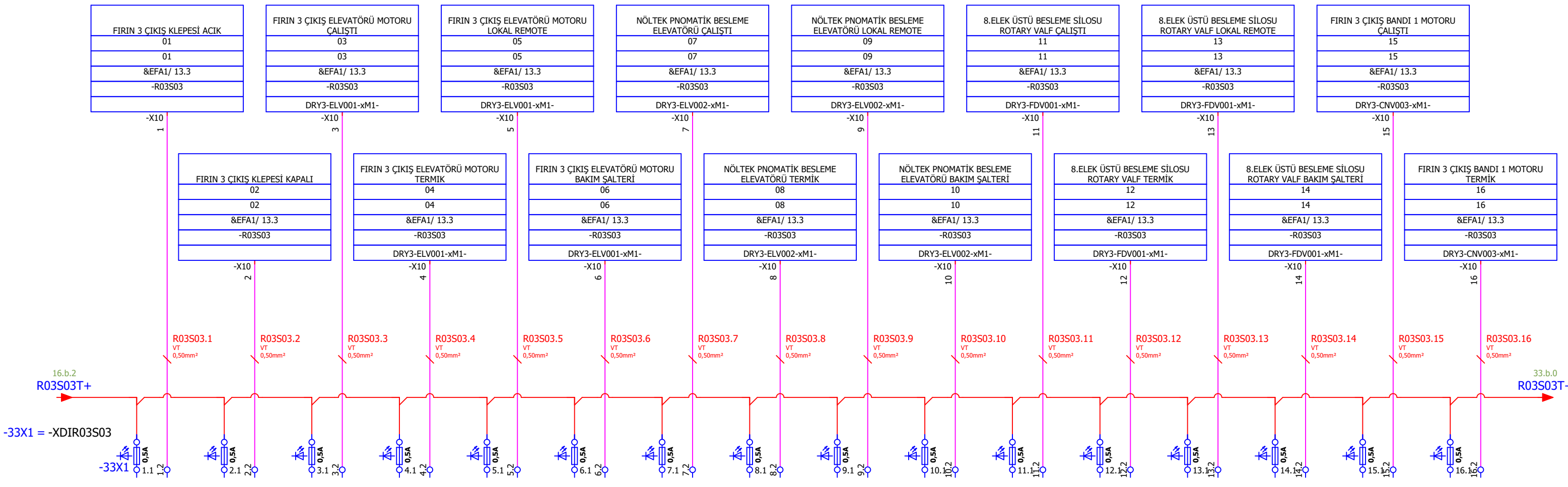

Çizen (Drawing)	Kontrol (Control)		Kontrol (Control)		Sayfa açıklaması (Page description)	Proje adı (Project name)	=	GB1
Necip SERT Proje Tasarım	Elc. / Eln. Eng. Mehmet CAN EMO Number : 34502		Proje Sorumlusu Yağmur KEPEZ		RACK - 3 SLOT - 2 Digital Input (32 Channel) (17-32) 2 WIRE	ESAN Çine ÜYS 1.Faz_Kurutma3	+	A2.B3
							Next page:	33.a
							Previous page:	32.a



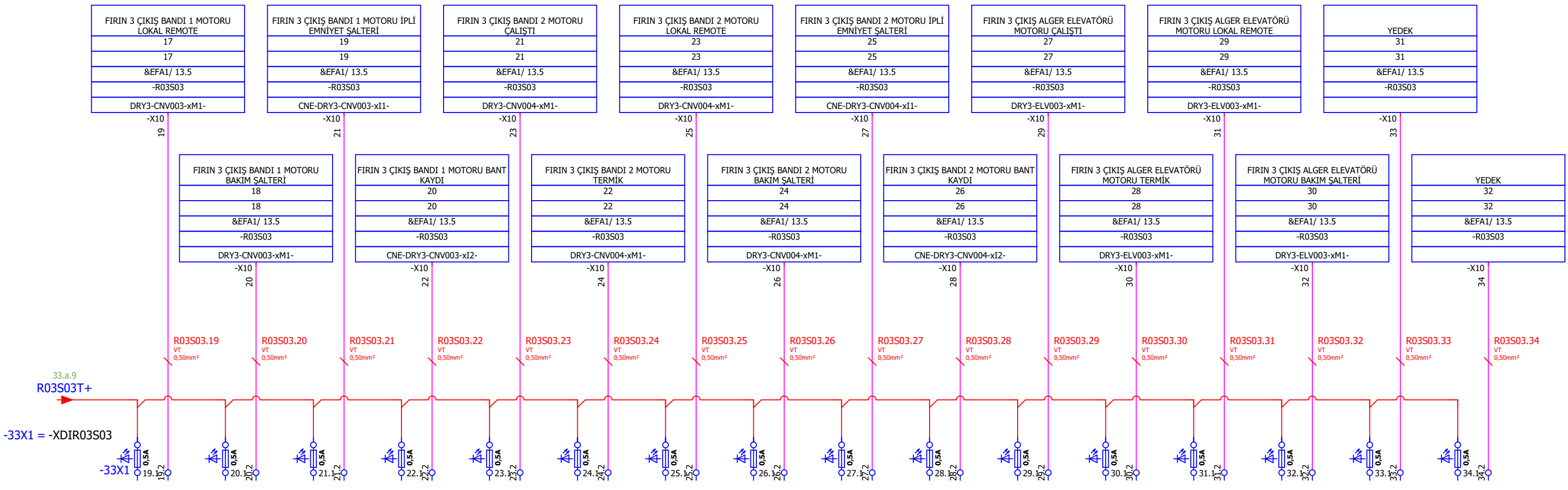

Çizen (Drawing)	Kontrol (Control)		Kontrol (Control)		Sayfa açıklaması (Page description)	Proje adı (Project name)	=	GB1
Necip SERT Proje Tasarım	Elc. / Eln. Eng. Mehmet CAN EMO Number : 34502		Proje Sorumlusu Yağmur KEPEZ		RACK - 3 SLOT - 3 Digital Input (32 Channel) (1-16) 2 WIRE	ESAN Çine ÜYS 1.Faz_Kurutma3	+	A2.B3
							Next page:	33.b
							Previous page:	32.b

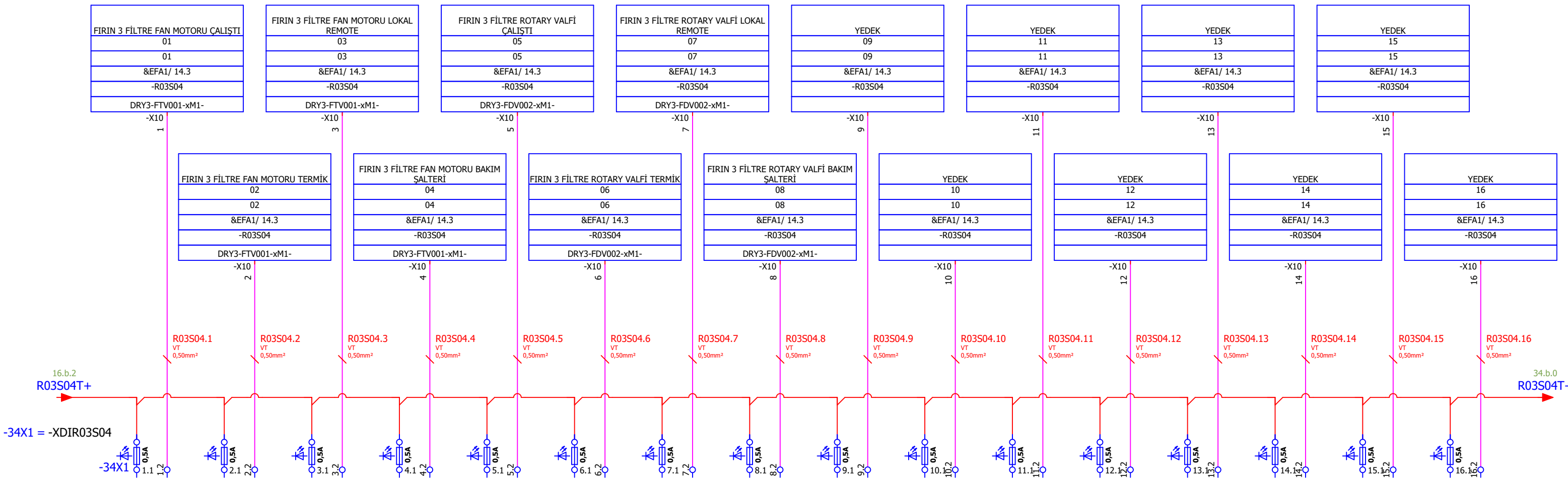

Çizen (Drawing)	Kontrol (Control)		Kontrol (Control)		Sayfa açıklaması (Page description)	Proje adı (Project name)	=	GB1
Necip SERT Proje Tasarım	Elc. / Eln. Eng. Mehmet CAN EMO Number : 34502		Proje Sorumlusu Yağmur KEPEZ		RACK - 3 SLOT - 3 Digital Input (32 Channel) (17-32) 2 WIRE	ESAN Çine ÜYS 1.Faz_Kurutma3	+	A2.B3
							Next page:	34.a
							Previous page:	33.a



-34X1 = -XDIR03S04

Çizen (Drawing) Necip SERT Proje Tasarım	Kontrol (Control) Elc. / Eln. Eng. Mehmet CAN EMO Number : 34502		Kontrol (Control) Proje Sorumlusu Yağmur KEPEZ		Sayfa açıklaması (Page description) RACK - 3 SLOT - 4 Digital Input (32 Channel) (1-16) 2 WIRE	Proje adı (Project name) ESAN Çine ÜYS 1.Faz_Kurutma3	= GB1 + A2.B3 Next page: 34.b Previous page: 33.b
--	--	---	--	---	---	--	--

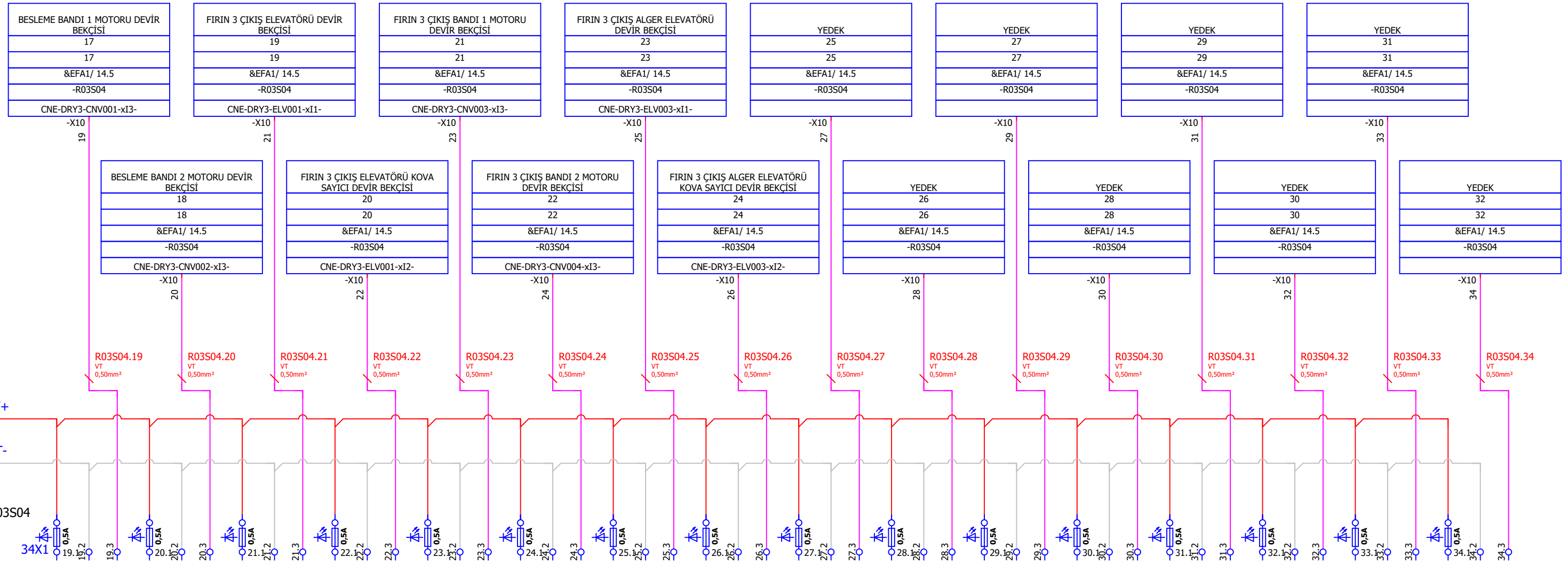

Çizen (Drawing)	Kontrol (Control)		Kontrol (Control)		Sayfa açıklaması (Page description)	Proje adı (Project name)	=	GB1
Necip SERT Proje Tasarım	Elc. / Eln. Eng. Mehmet CAN EMO Number : 34502		Proje Sorumlusu Yağmur KEPEZ		RACK - 3 SLOT - 4 Digital Input (32 Channel) (17-32) 3 WIRE	ESAN Çine ÜYS 1.Faz_Kurutma3	+	A2.B3
					Next page:		35.a	
					Previous page:		34.a	

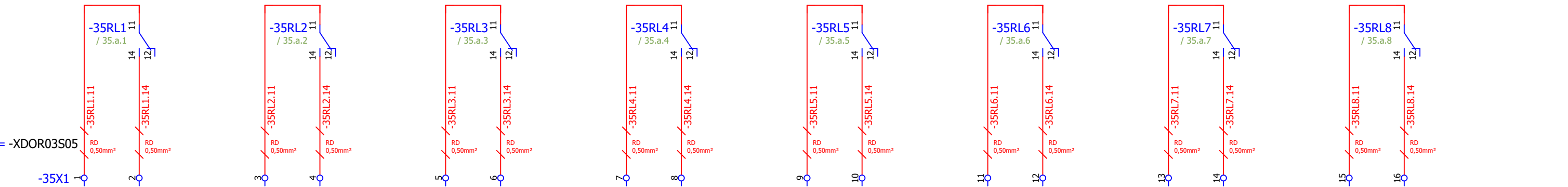
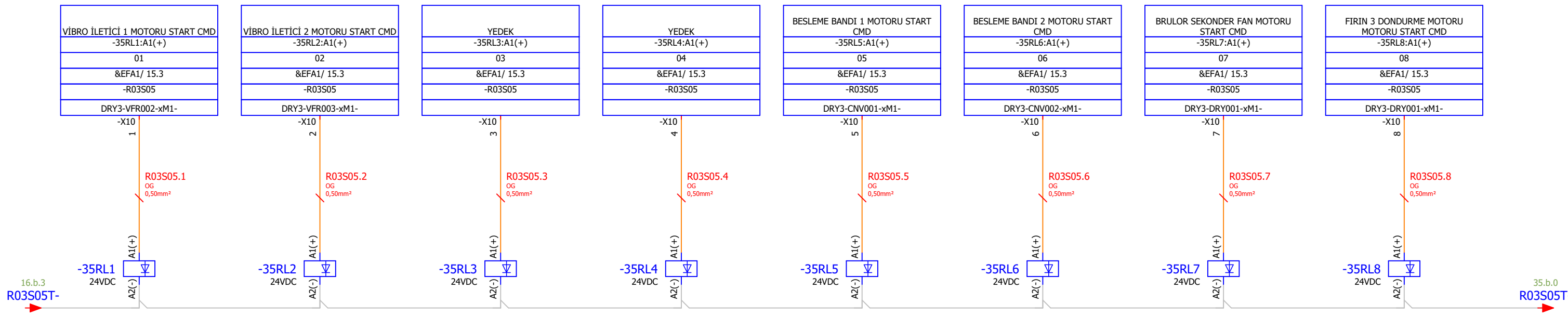

-35X1 = -XDOR03S05

Çizen (Drawing) Necip SERT Proje Tasarım	Kontrol (Control) Elc. / Eln. Eng. Mehmet CAN EMO Number : 34502		Kontrol (Control) Proje Sorumlusu Yağmur KEPEZ		Sayfa açıklaması (Page description) RACK - 3 SLOT - 5 Digital Output (32 Channel) (1-8) DRY CONTACT	Proje adı (Project name) ESAN Çine ÜYS 1.Faz_Kurutma3	= GB1 + A2.B3 Next page: 35.b Previous page: 34.b
--	--	--	--	--	--	--	--

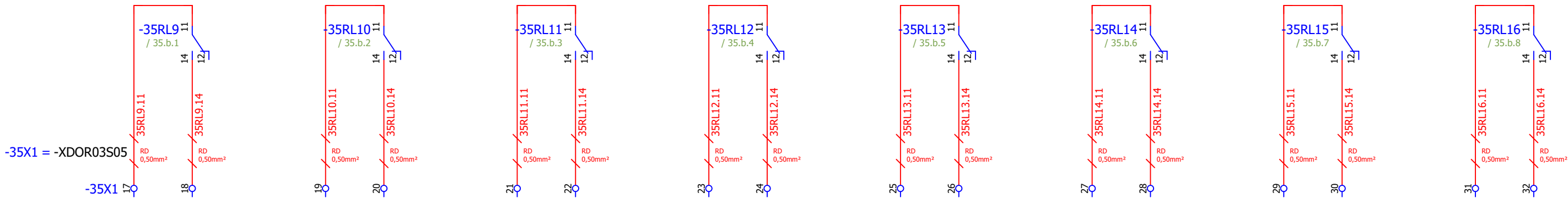
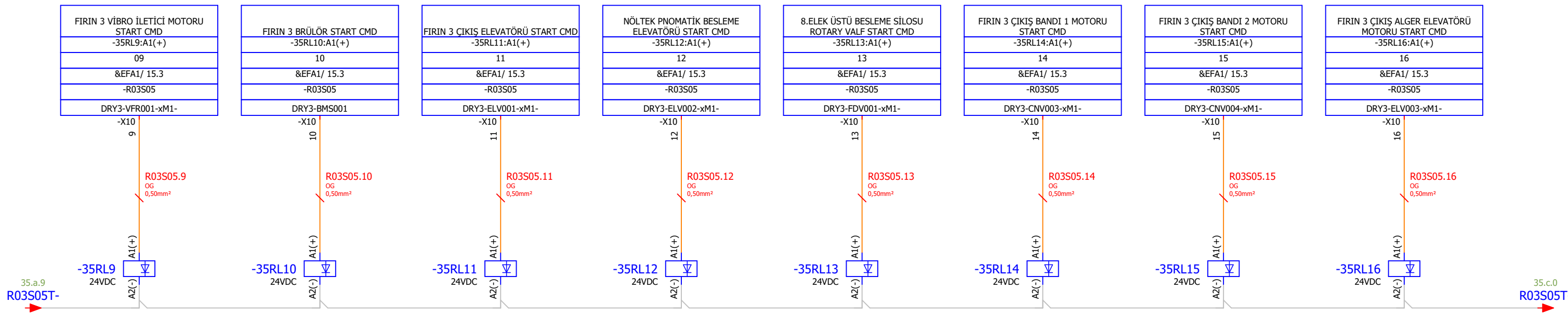

Çizen (Drawing)	Kontrol (Control)		Kontrol (Control)		Sayfa açıklaması (Page description)	Proje adı (Project name)	=	GB1
Necip SERT Proje Tasarım	Elc. / Eln. Eng. Mehmet CAN EMO Number : 34502		Proje Sorumlusu Yağmur KEPEZ		RACK - 3 SLOT - 5 Digital Output (32 Channel) (9-16) DRY CONTACT	ESAN Çine ÜYS 1.Faz_Kurutma3	+	A2.B3
							Next page:	35.c
							Previous page:	35.a

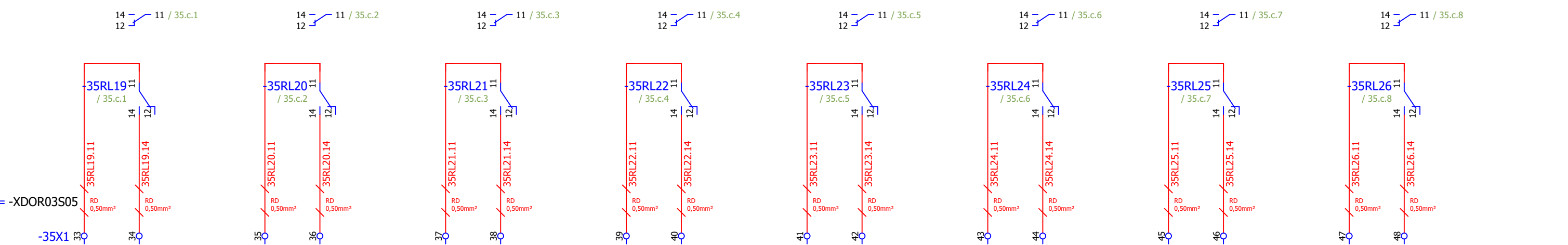
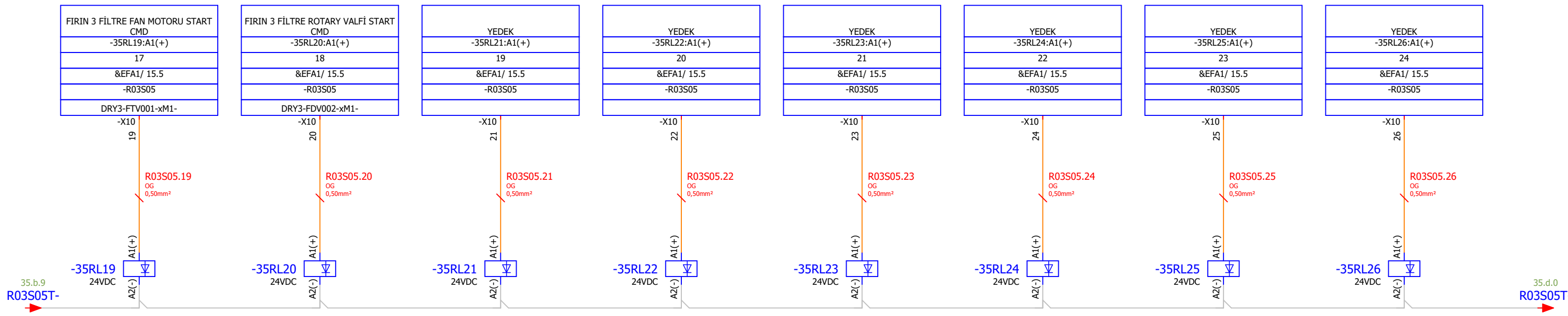

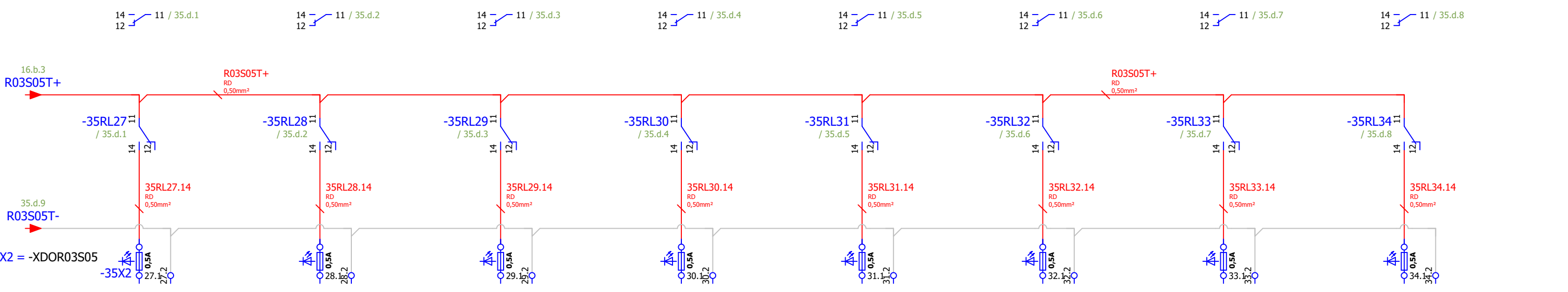
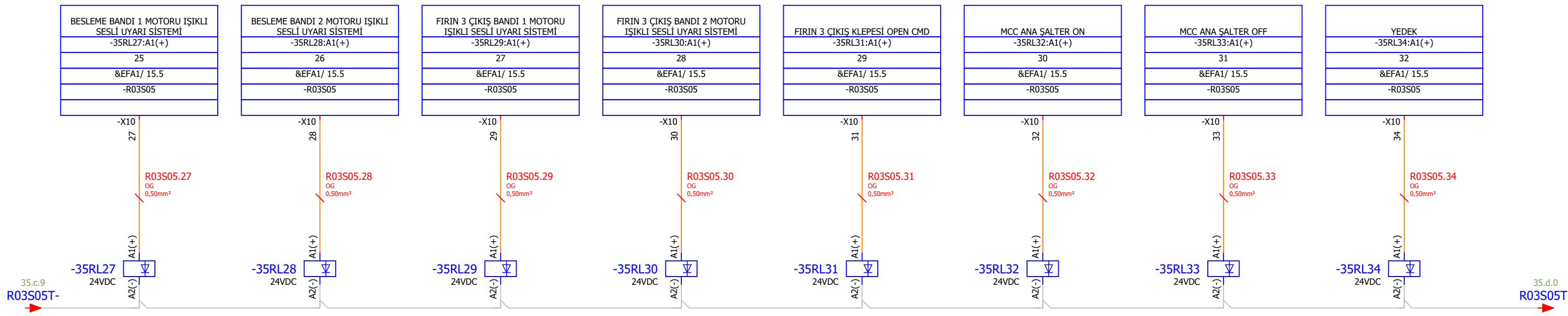

Çizen (Drawing)	Kontrol (Control)		Kontrol (Control)		Sayfa açıklaması (Page description)	Proje adı (Project name)	=	GB1
Necip SERT Proje Tasarım	Elc. / Eln. Eng. Mehmet CAN EMO Number : 34502		Proje Sorumlusu Yağmur KEPEZ		RACK - 3 SLOT - 5 Digital Output (32 Channel) (17-22) DRY CONTACT	ESAN Çine ÜYS 1.Faz_Kurutma3	+	A2.B3
							Next page:	35.d
							Previous page:	35.b



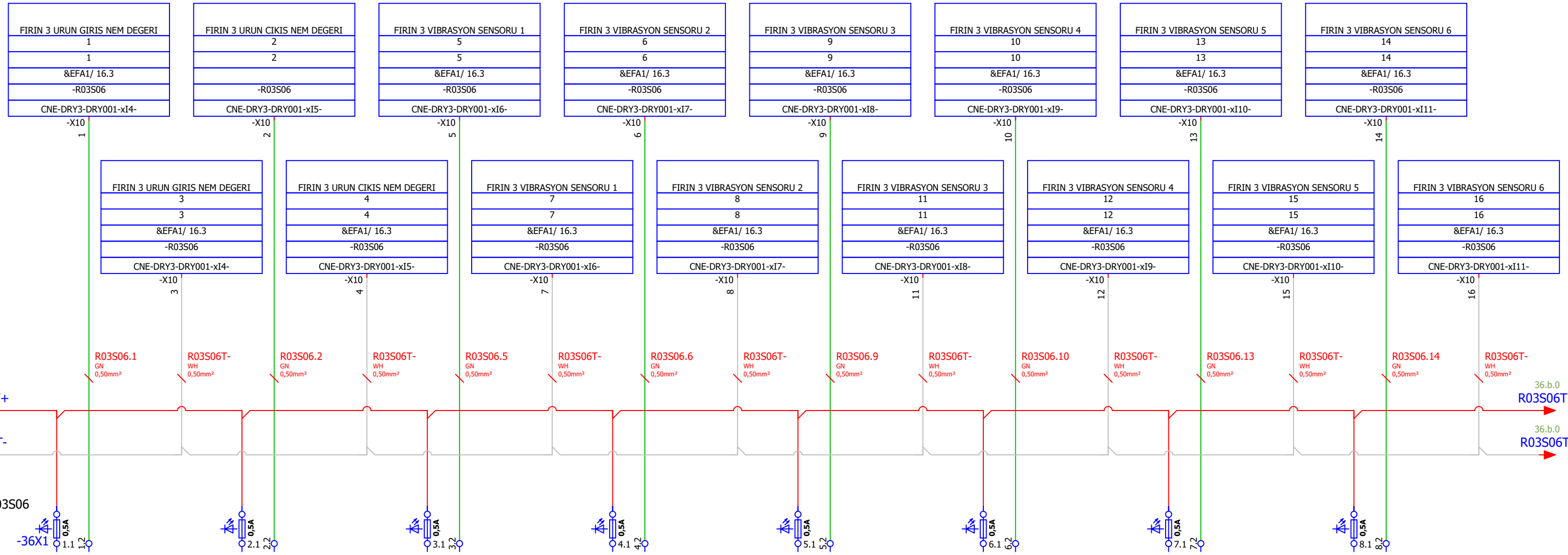

Çizen (Drawing)	Kontrol (Control)		Kontrol (Control)		Sayfa açıklaması (Page description)	Proje adı (Project name)	=	GB1
Necip SERT Proje Tasarım	Elc. / Eln. Eng. Mehmet CAN EMO Number : 34502		Proje Sorumlusu Yağmur KEPEZ		RACK - 3 SLOT - 5 Digital Output (32 Channel) (23-32) LİVE CONTACT	ESAN Çine ÜYS 1.Faz_Kurutma3	+	A2.B3
							Next page:	36.a
							Previous page:	35.c

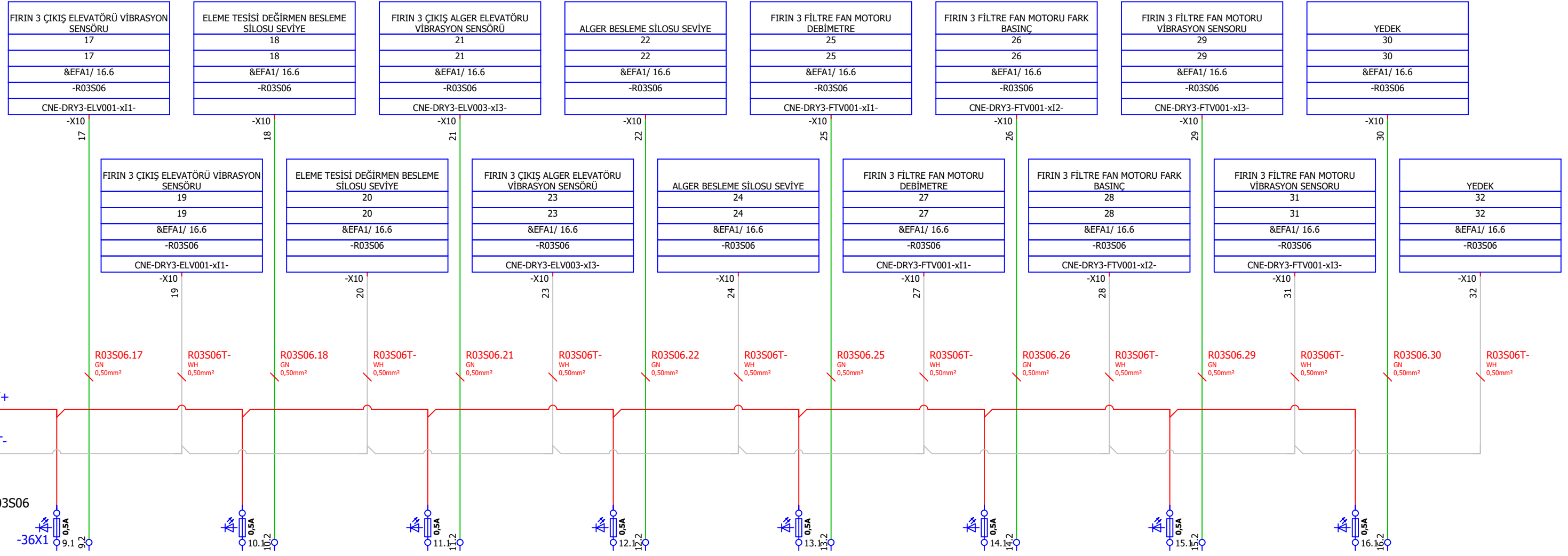

Çizen (Drawing)	Kontrol (Control)		Kontrol (Control)		Sayfa açıklaması (Page description)	Proje adı (Project name)	=	GB1
Necip SERT Proje Tasarım	Elc. / Eln. Eng. Mehmet CAN EMO Number : 34502		Proje Sorumlusu Yağmur KEPEZ		RACK - 3 SLOT - 6 Analog Input (16 Channel) (1-8) HI LEVEL	ESAN Çine ÜYS 1.Faz_Kurutma3	+	A2.B3
							Next page:	36.b
							Previous page:	35.d



Çizen (Drawing)	Kontrol (Control)		Kontrol (Control)		Sayfa açıklaması (Page description)	Proje adı (Project name)	=	GB1
Necip SERT Proje Tasarım	Elc. / Eln. Eng. Mehmet CAN EMO Number : 34502		Proje Sorumlusu Yağmur KEPEZ		RACK - 3 SLOT - 6 Analog Input (16 Channel) (9-16) HI LEVEL	ESAN Çine ÜYS 1.Faz_Kurutma3	+	A2.B3
							Next page:	37.a
							Previous page:	36.a

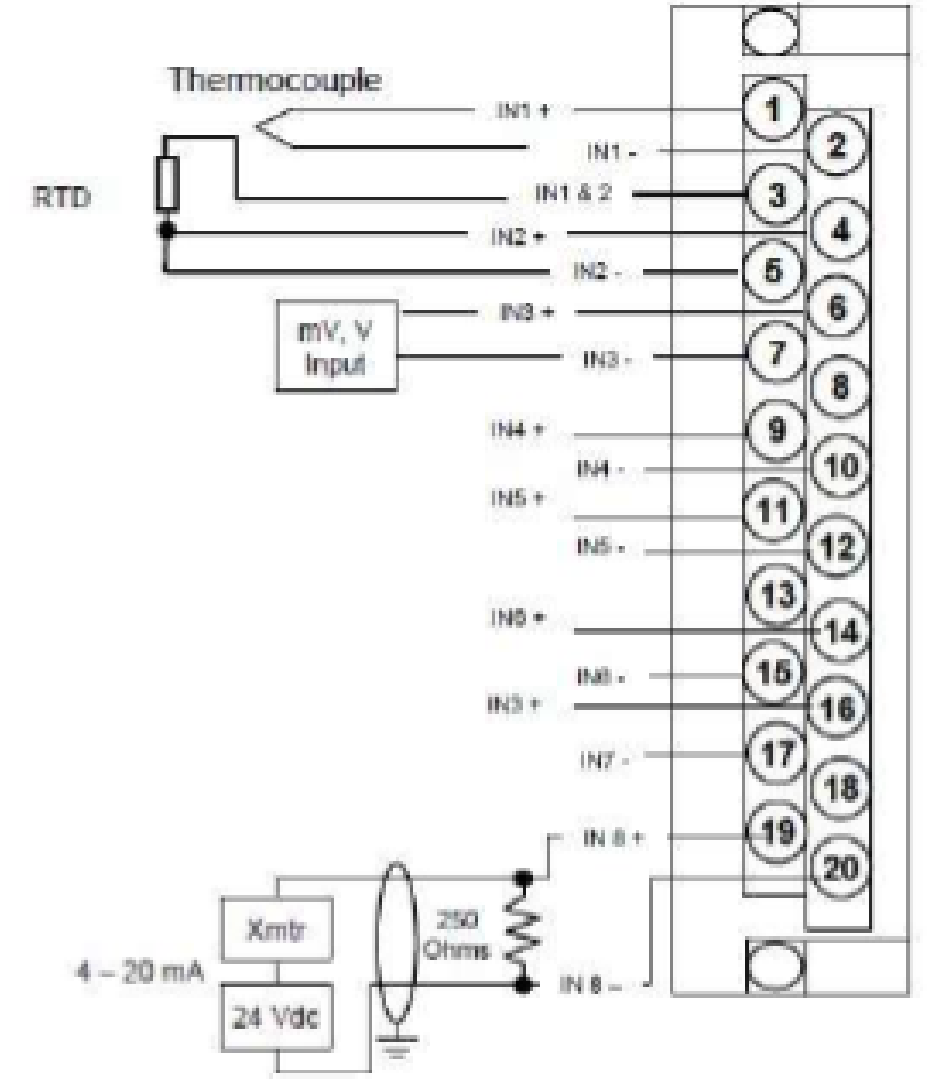
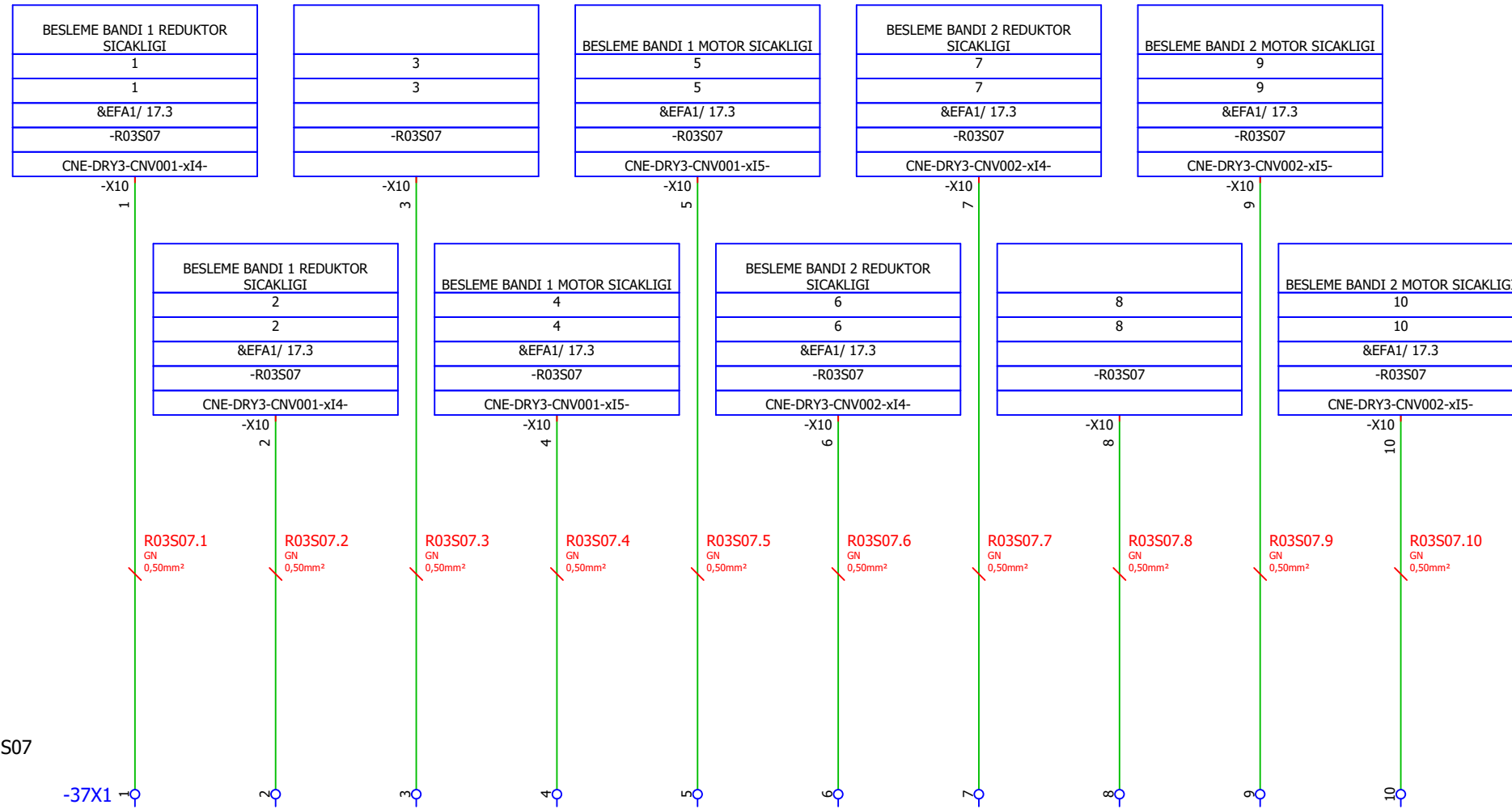

Çizen (Drawing)	Kontrol (Control)		Kontrol (Control)		Sayfa açıklaması (Page description)	Proje adı (Project name)	=	GB1
Necip SERT Proje Tasarım	Elc. / Eln. Eng. Mehmet CAN EMO Number : 34502		Proje Sorumlusu Yağmur KEPEZ		RACK - 3 SLOT - 7 Analog Input (8 Channel) (1-4) RTD	ESAN Çine ÜYS 1.Faz_Kurutma3	Next page:	37.b
							Previous page:	36.b

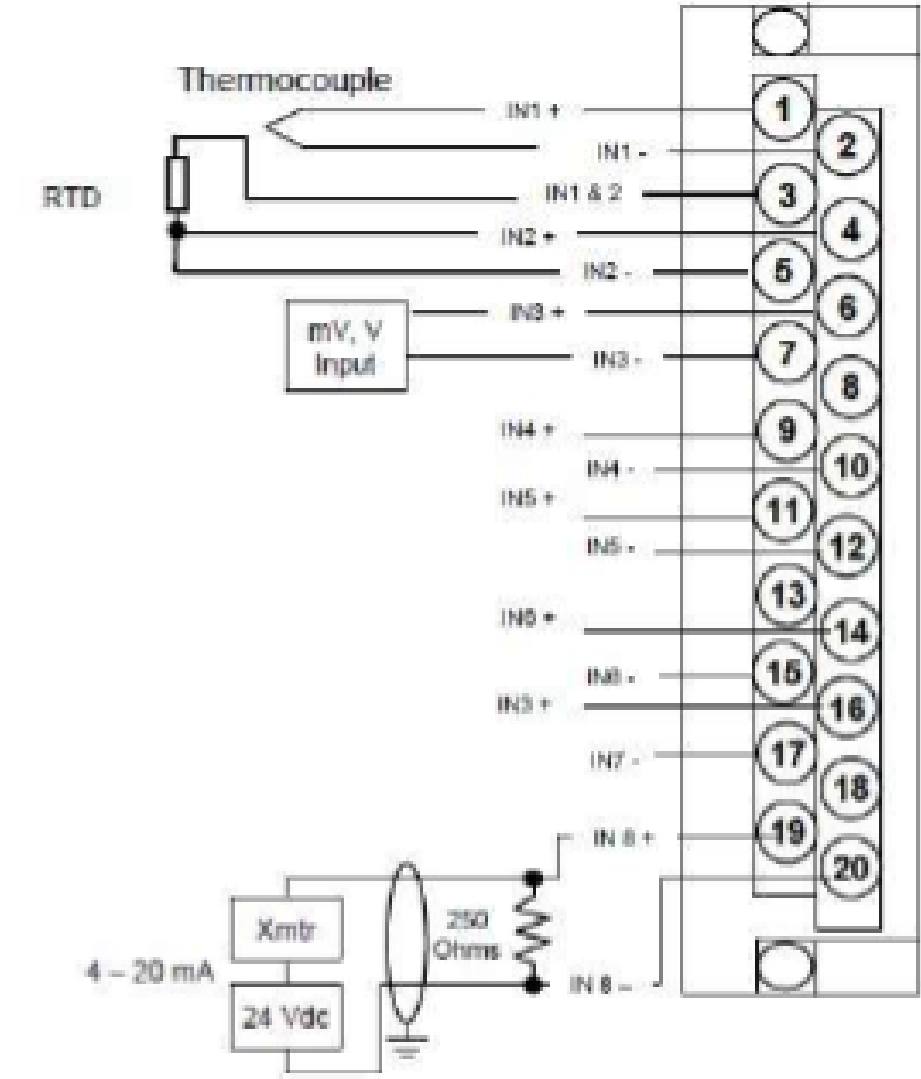
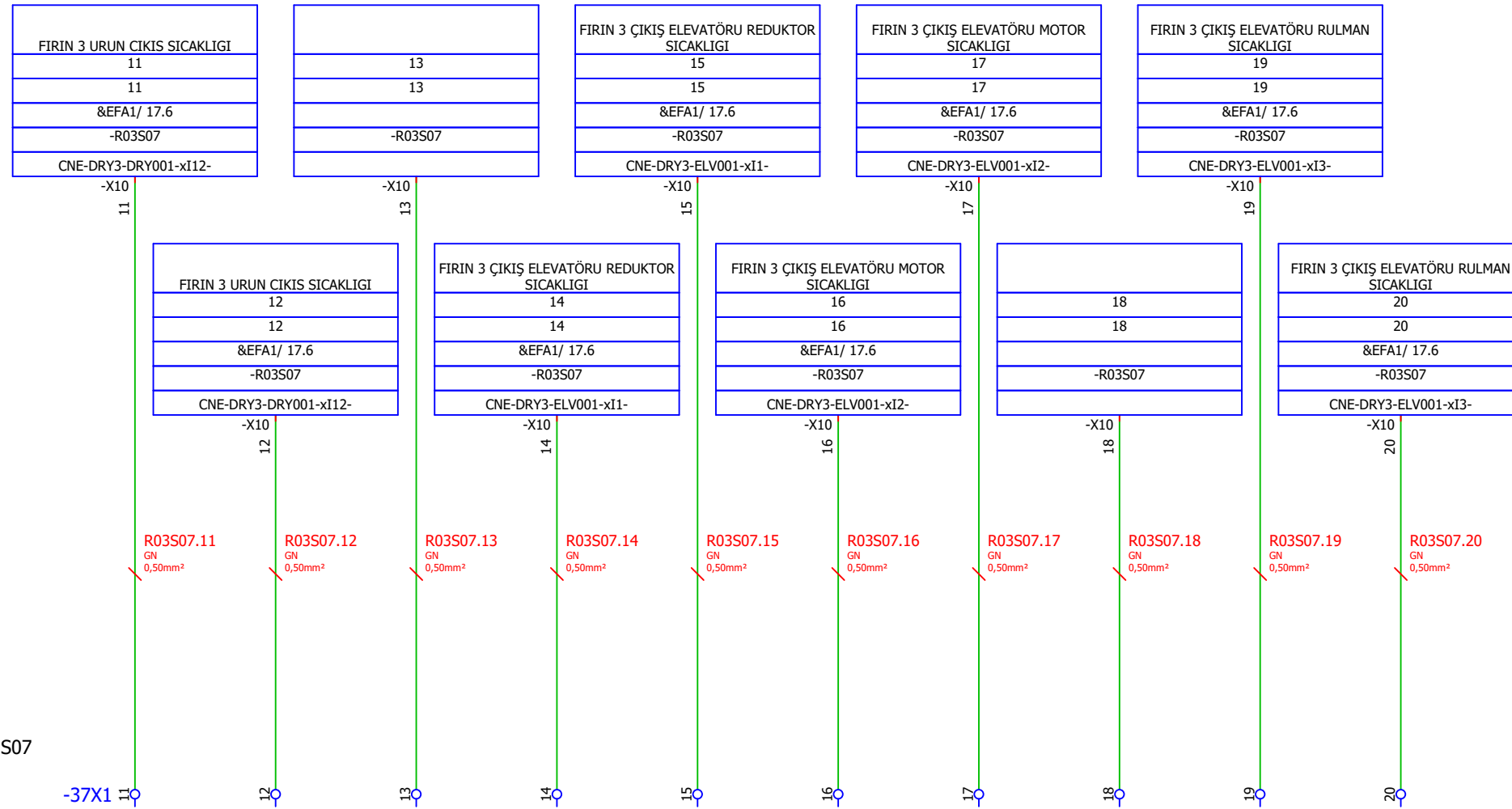

-37X1 = -XAIR03S07

Çizen (Drawing) Necip SERT Proje Tasarım	Kontrol (Control) Elc. / Eln. Eng. Mehmet CAN EMO Number : 34502		Kontrol (Control) Proje Sorumlusu Yağmur KEPEZ		Sayfa açıklaması (Page description) RACK - 3 SLOT - 7 Analog Input (8 Channel) (5-8) RTD	Proje adı (Project name) ESAN Çine ÜYS 1.Faz_Kurutma3	= + Next page: Previous page:	GB1 A2.B3 38.a 37.a
--	--	--	--	--	---	--	--	------------------------------

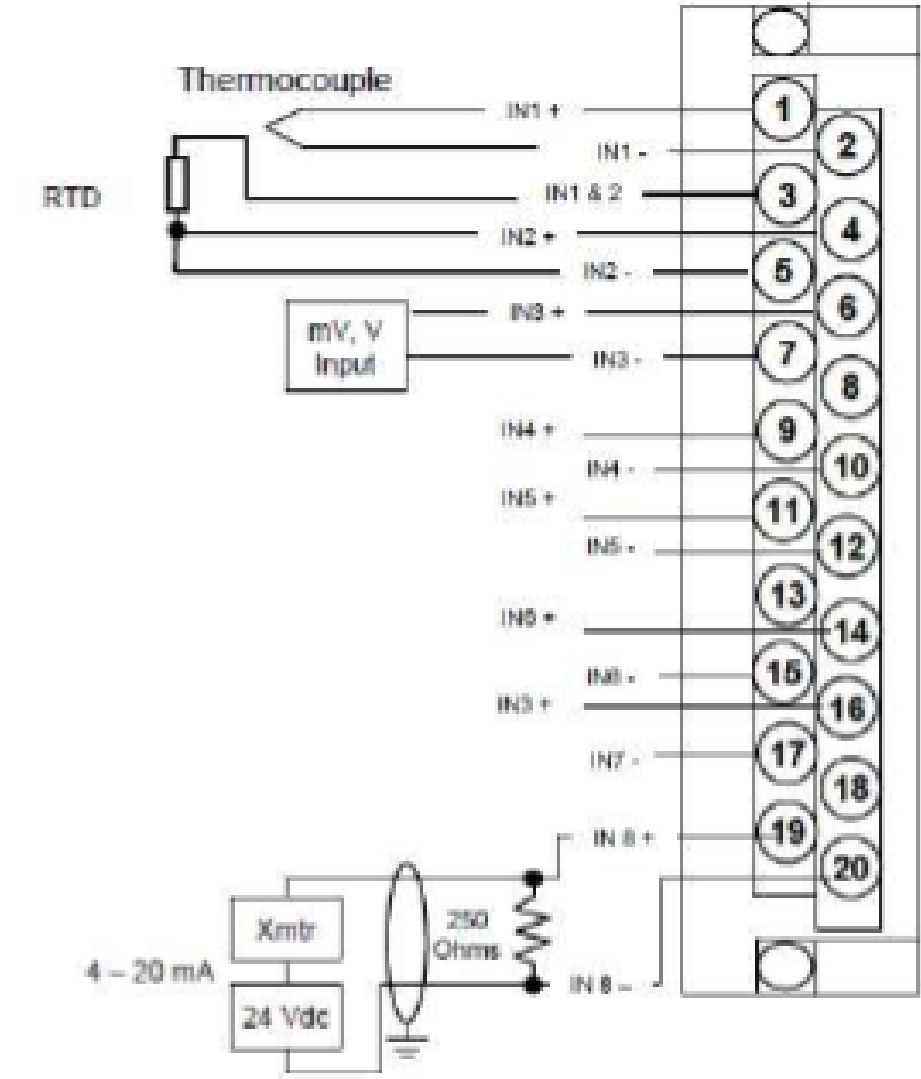

-38X1 = -XAIR03S08

Çizen (Drawing)	Kontrol (Control)		Kontrol (Control)		Sayfa açıklaması (Page description)	Proje adı (Project name)	=	GB1
Necip SERT Proje Tasarım	Elc. / Eln. Eng. Mehmet CAN EMO Number : 34502		Proje Sorumlusu Yağmur KEPEZ		RACK - 3 SLOT - 8 Analog Input (8 Channel) (1-4) RTD	ESAN Çine ÜYS 1.Faz_Kurutma3	+	A2.B3
							Next page:	38.b
							Previous page:	37.b

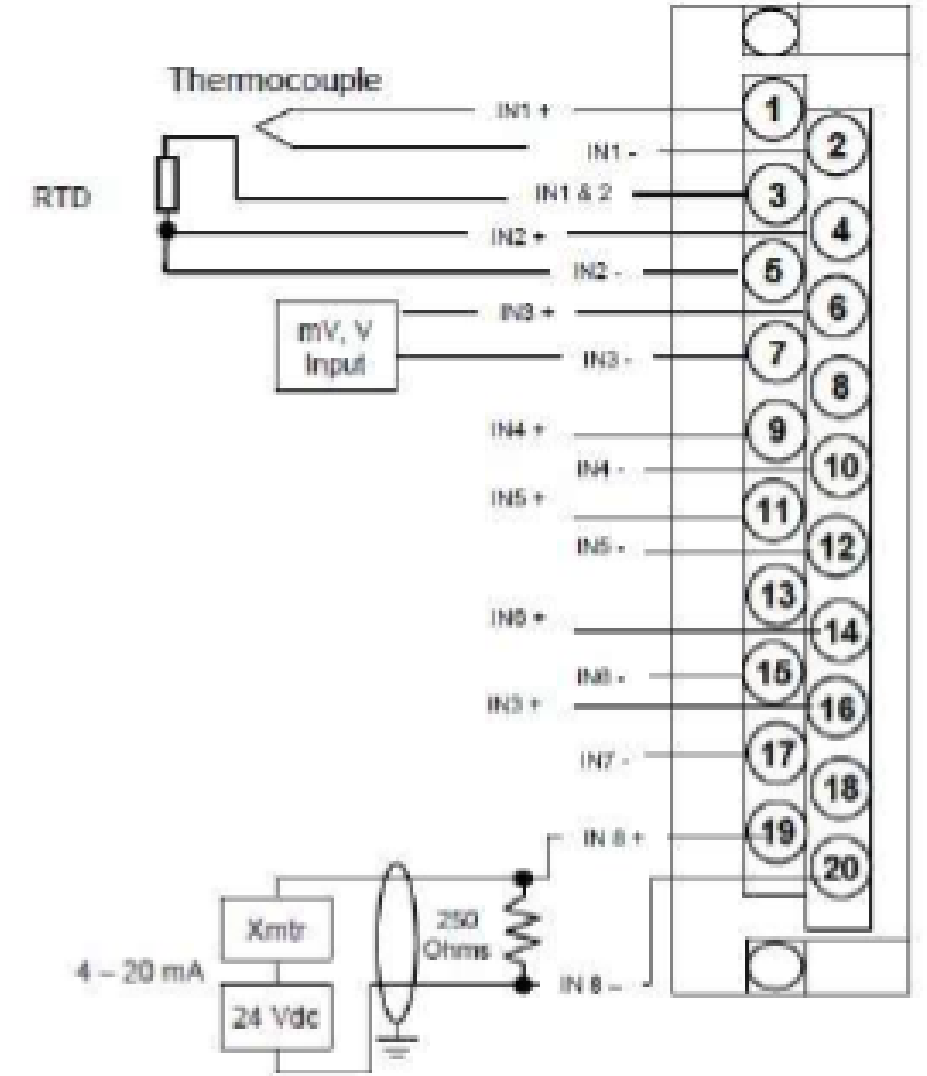
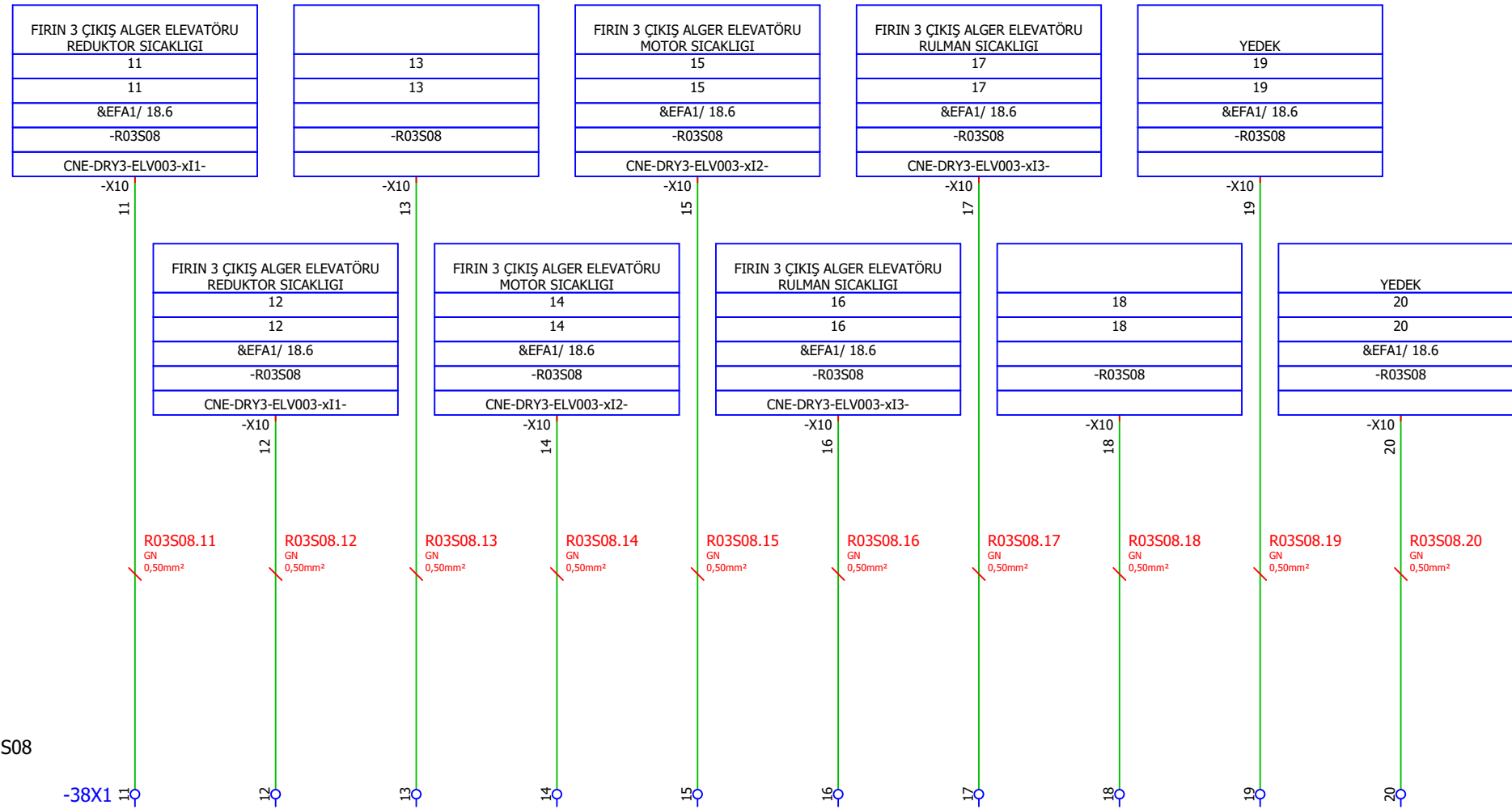

Çizen (Drawing)	Kontrol (Control)		Kontrol (Control)		Sayfa açıklaması (Page description)	Proje adı (Project name)	=	GB1
Necip SERT Proje Tasarım	Elc. / Eln. Eng. Mehmet CAN EMO Number : 34502		Proje Sorumlusu Yağmur KEPEZ		RACK - 3 SLOT - 8 Analog Input (8 Channel) (5-8) RTD	ESAN Çine ÜYS 1.Faz_Kurutma3	+	A2.B3
							Next page:	39.a
							Previous page:	38.a

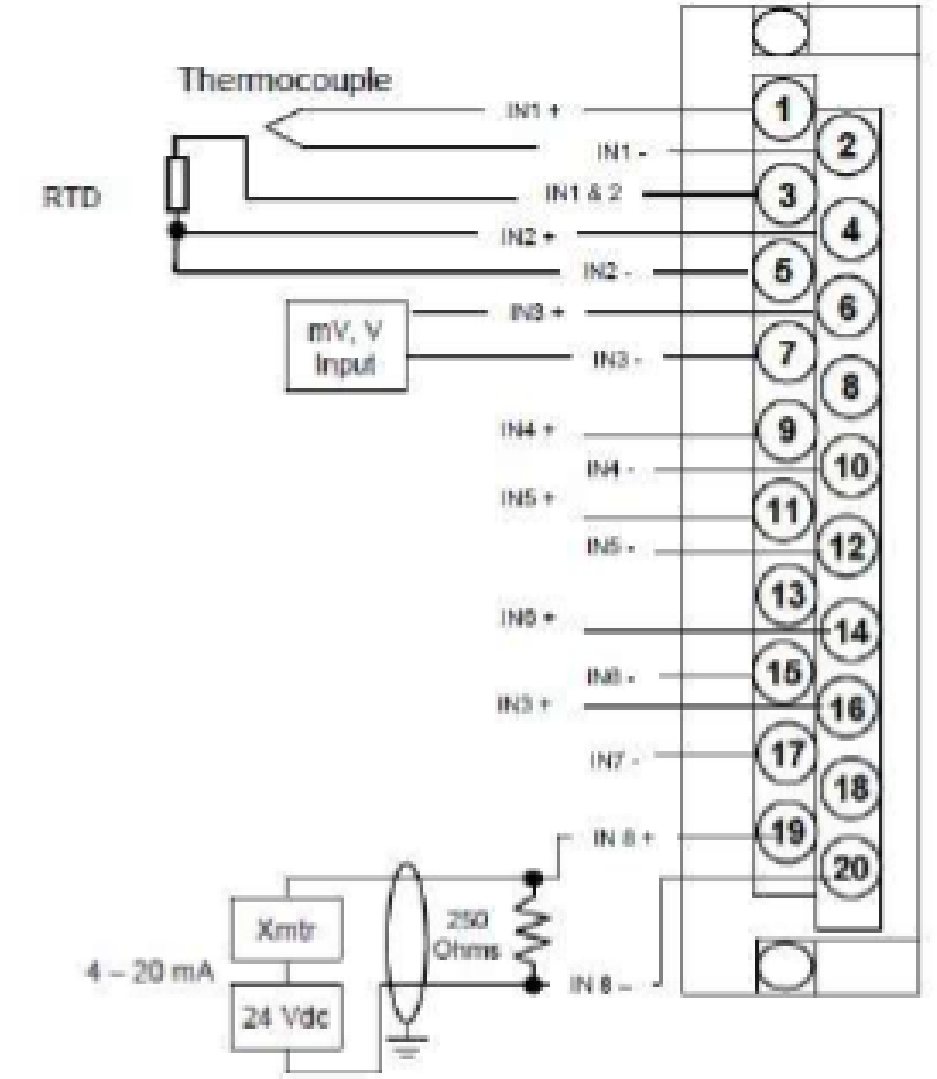
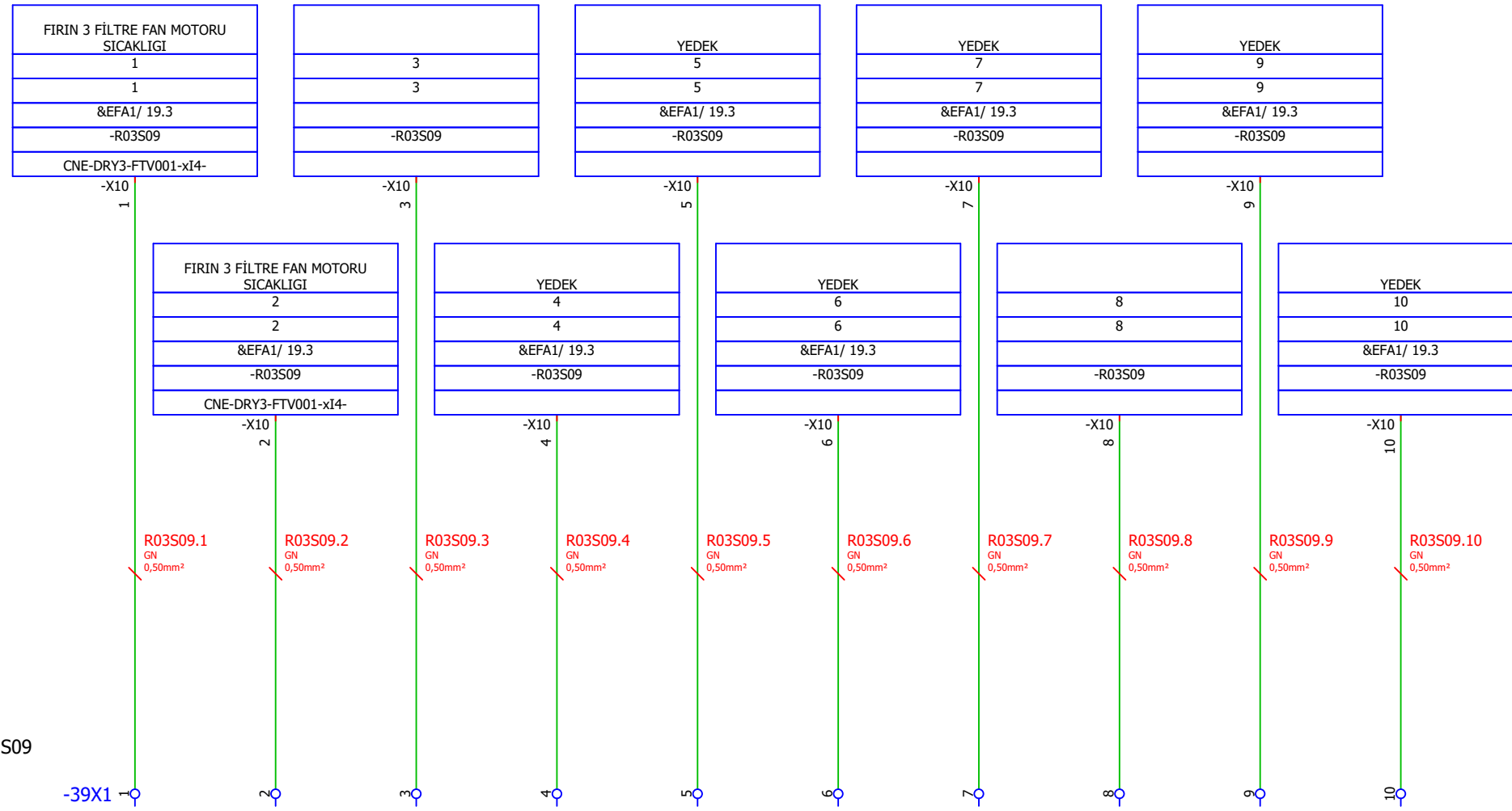

-39X1 = -XAIR03S09

Çizen (Drawing)	Kontrol (Control)		Kontrol (Control)		Sayfa açıklaması (Page description)	Proje adı (Project name)	=	GB1
Necip SERT Proje Tasarım	Elc. / Eln. Eng. Mehmet CAN EMO Number : 34502		Proje Sorumlusu Yağmur KEPEZ		RACK - 3 SLOT - 9 Analog Input (8 Channel) (1-4) RTD	ESAN Çine ÜYS 1.Faz_Kurutma3	+	A2.B3
							Next page:	39.b
							Previous page:	38.b

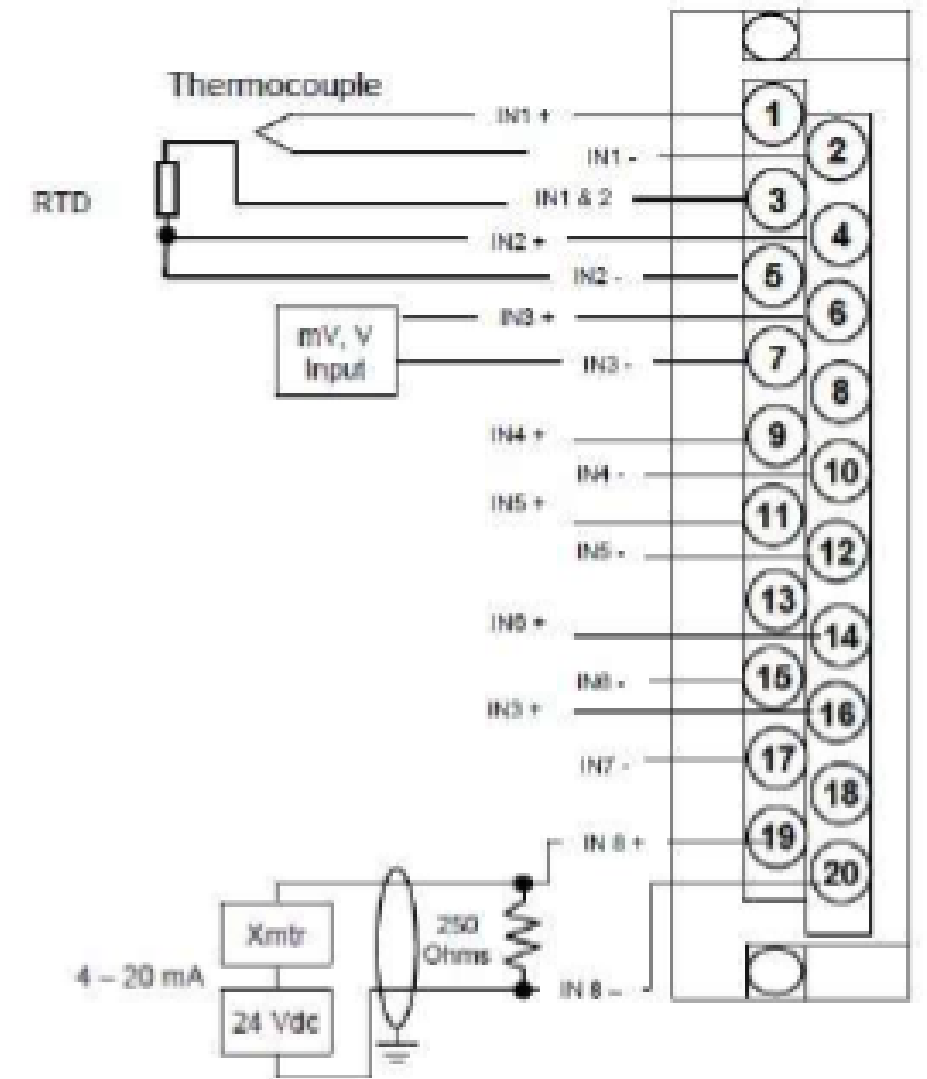
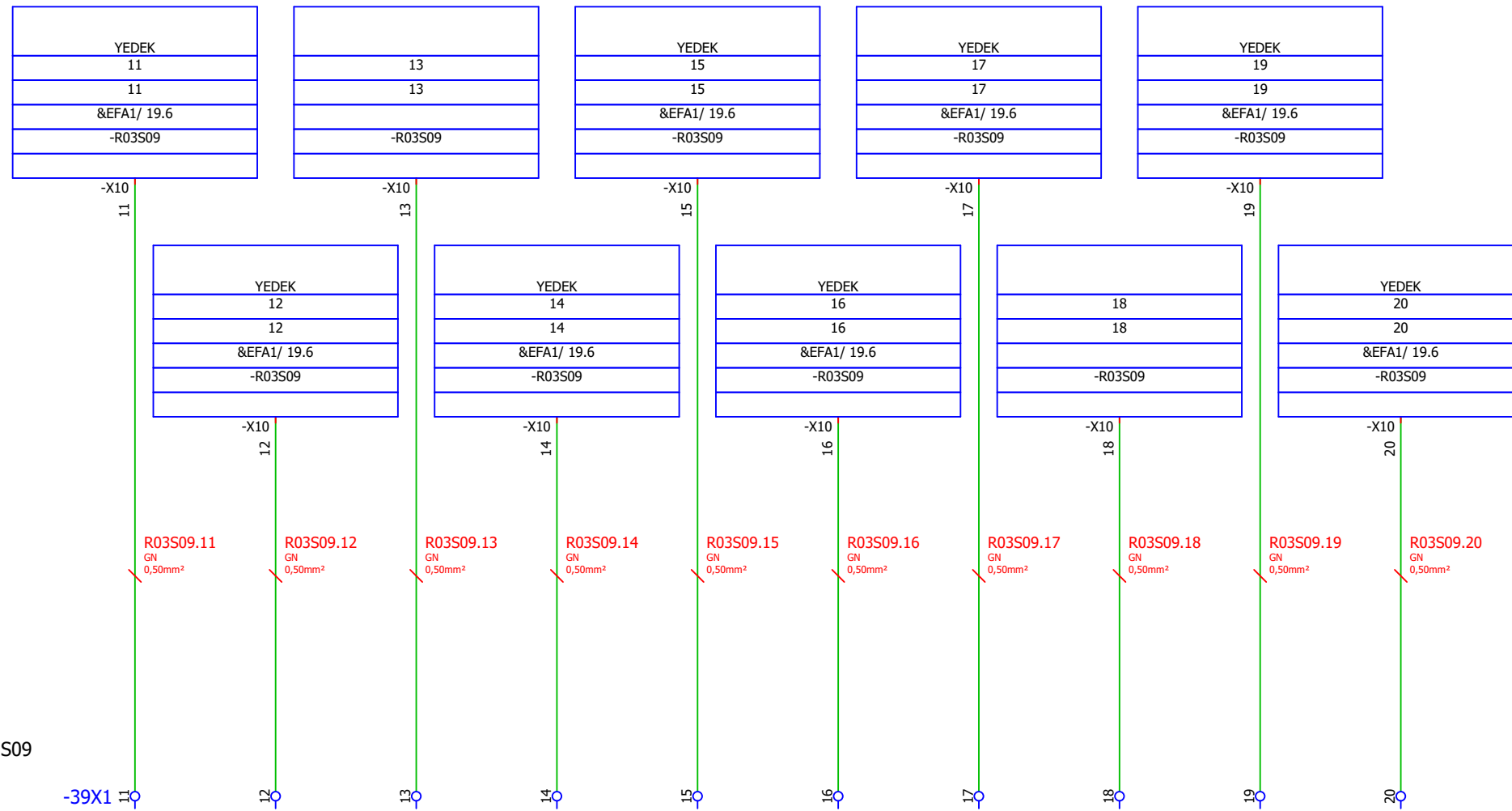

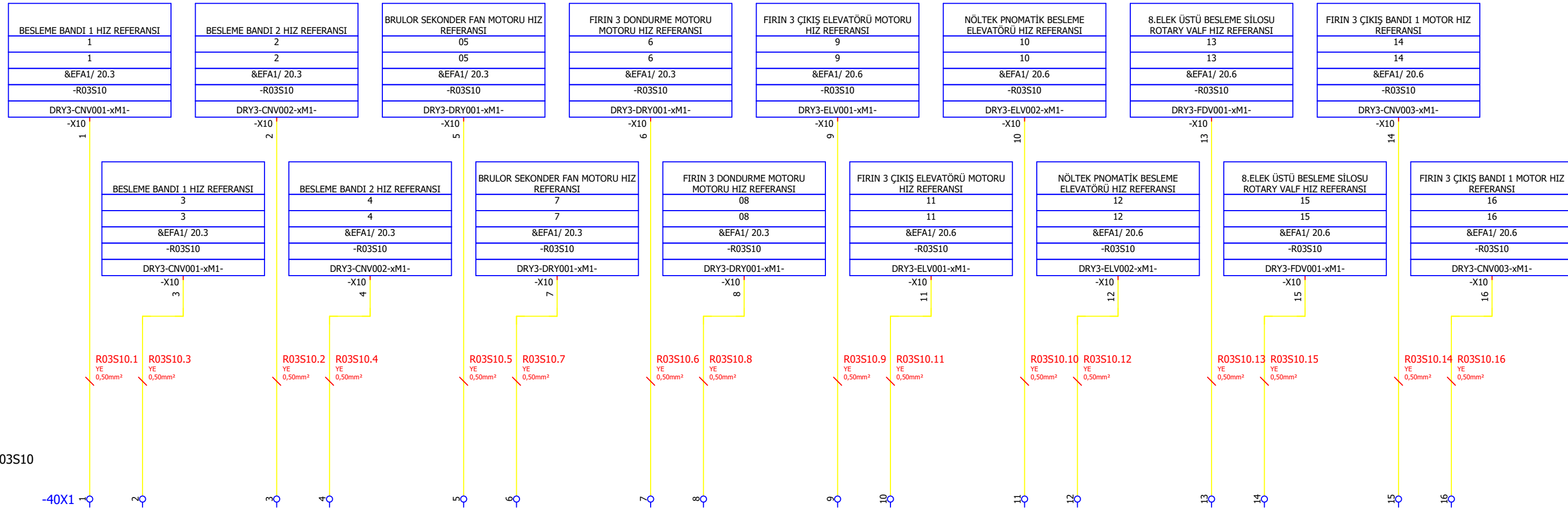

Çizen (Drawing)	Kontrol (Control)		Kontrol (Control)		Sayfa açıklaması (Page description)	Proje adı (Project name)	=	GB1
Necip SERT Proje Tasarım	Elc. / Eln. Eng. Mehmet CAN EMO Number : 34502		Proje Sorumlusu Yağmur KEPEZ		RACK - 3 SLOT - 9 Analog Input (8 Channel) (5-8) RTD	ESAN Çine ÜYS 1.Faz_Kurutma3	+	A2.B3
							Next page:	40
							Previous page:	39.a

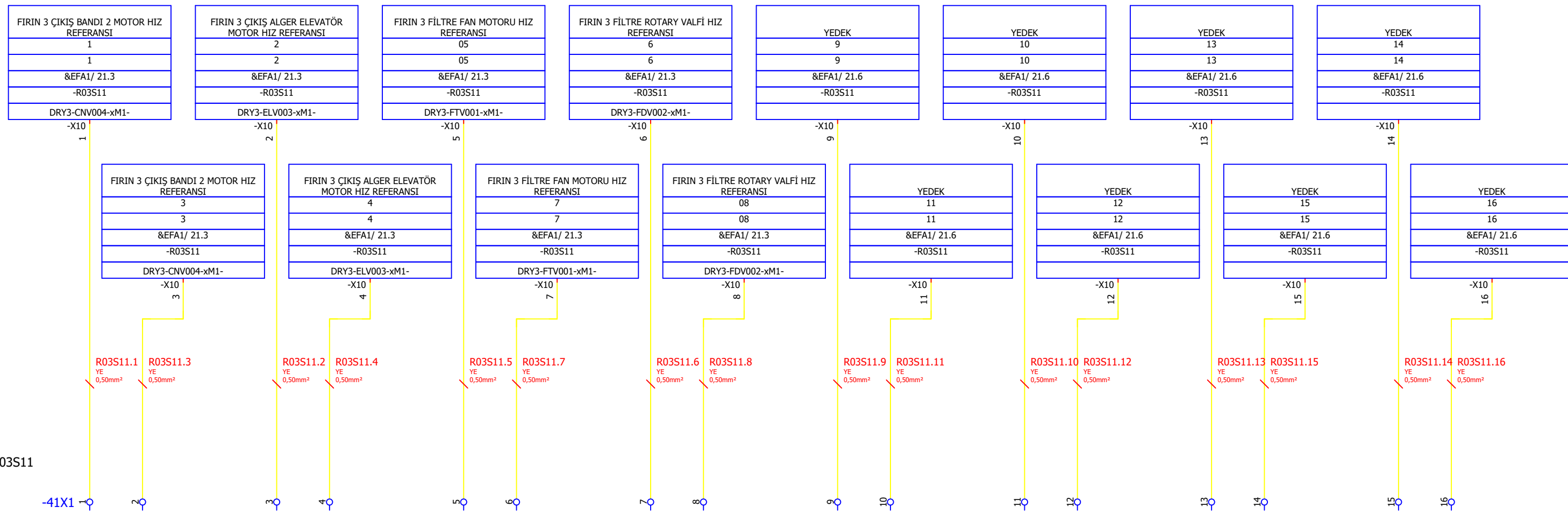

Çizen (Drawing)	Kontrol (Control)		Kontrol (Control)		Sayfa açıklaması (Page description)	Proje adı (Project name)	=	40
Necip SERT Proje Tasarım	Elc. / Eln. Eng. Mehmet CAN EMO Number : 34502		Proje Sorumlusu Yağmur KEPEZ		RACK - 3 SLOT - 10 Analog Output (8 Channel) (1-8) 2 WIRE	ESAN Çine ÜYS 1.Faz_Kurutma3	+	A2.B3
							Next page:	41
							Previous page:	39.b



Çizen (Drawing)	Kontrol (Control)		Kontrol (Control)		Sayfa açıklaması (Page description)	Proje adı (Project name)	=	GB1
Necip SERT Proje Tasarım	Elc. / Eln. Eng. Mehmet CAN EMO Number : 34502		Proje Sorumlusu Yağmur KEPEZ		RACK - 3 SLOT - 11 Analog Output (8 Channel) (1-8) 2 WIRE	ESAN Çine ÜYS 1.Faz_Kurutma3	+	A2.B3
							Next page:	
					Previous page:		40	