 **MITSUBISHI  
ELECTRIC**  
**INVERTER**



# FR-A800

# INSTRUCTION MANUAL (DETAILED)

---

*High functionality and high performance*

**FR-A820-00046(0.4K) to 04750(90K)(-GF)**  
**FR-A840-00023(0.4K) to 06830(280K)(-GF)**  
**FR-A842-07700(315K) to 12120(500K)(-GF)**  
**FR-A846-00023(0.4K) to 03610(132K)**

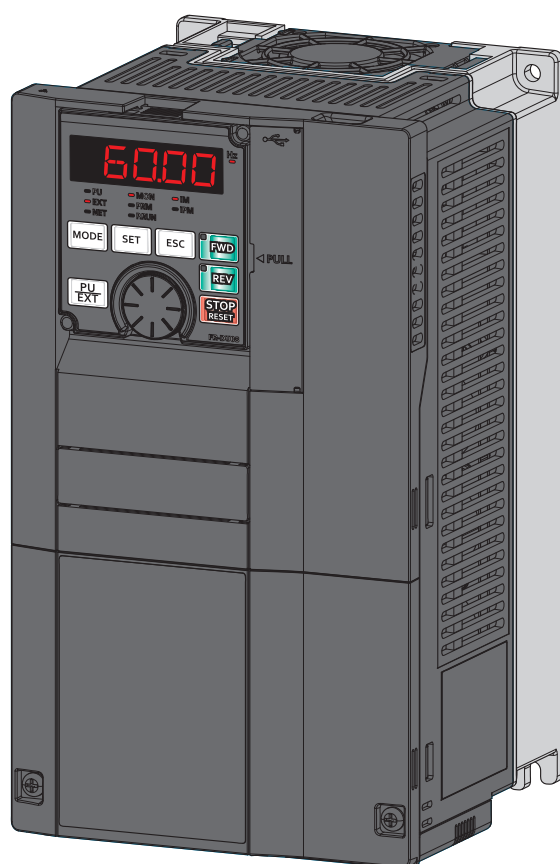

Safety instructions . . . . .	9
-------------------------------	---

## **Chapter 1 INTRODUCTION . . . . . 16**

1.1 Product checking and accessories . . . . .	17
1.2 Component names . . . . .	19
1.3 Operation steps . . . . .	21
1.4 Related manuals . . . . .	23

## **Chapter 2 INSTALLATION AND WIRING . . . . . 26**

2.1 Peripheral devices . . . . .	27
2.1.1 Inverter and peripheral devices . . . . .	27
2.1.2 Peripheral devices . . . . .	29
2.2 Removal and reinstallation of the operation panel or the front covers . . . . .	33
2.3 Installation of the inverter and enclosure design . . . . .	37
2.3.1 Inverter installation environment . . . . .	37
2.3.2 Amount of heat generated by the inverter . . . . .	40
2.3.3 Cooling system types for inverter enclosure . . . . .	41
2.3.4 Inverter installation . . . . .	42
2.3.5 Protruding the heat sink through a panel . . . . .	44
2.4 Terminal connection diagrams . . . . .	46
2.5 Main circuit terminals . . . . .	54
2.5.1 Details on the main circuit terminals . . . . .	54
2.5.2 Main circuit terminal layout and wiring to power supply and motor . . . . .	55
2.5.3 Recommended cables and wiring length . . . . .	57
2.5.4 Earthing (grounding) precautions . . . . .	67
2.6 Control circuit . . . . .	68
2.6.1 Details on the control circuit terminals . . . . .	68
2.6.2 Control logic (sink/source) change . . . . .	72
2.6.3 Wiring of control circuit . . . . .	74
2.6.4 Wiring precautions . . . . .	77
2.6.5 When using separate power supplies for the control circuit and the main circuit . . . . .	77
2.6.6 When supplying 24 V external power to the control circuit . . . . .	80
2.6.7 Safety stop function . . . . .	82
2.7 Communication connectors and terminals . . . . .	84
2.7.1 PU connector . . . . .	84
2.7.2 USB connector . . . . .	85
2.7.3 RS-485 terminal block . . . . .	86
2.8 Connection to a motor with encoder (Vector control) . . . . .	87

2.9	Parameter settings for a motor with encoder .....	94
<hr/>		
2.10	Connection of stand-alone option units .....	97
<hr/>		
2.10.1	Connection of the brake resistor .....	97
2.10.2	Connection of the brake unit (FR-BU2) .....	100
2.10.3	Connection of the brake unit (FR-BU) .....	103
2.10.4	Connection of the brake unit (BU type) .....	103
2.10.5	Connection of the high power factor converter (FR-HC2) .....	104
2.10.6	Connection of the multifunction regeneration converter (FR-XC) .....	105
2.10.7	Connection of the power regeneration common converter (FR-CV) .....	107
2.10.8	Connection of the power regeneration converter (MT-RC) .....	108
2.10.9	Connection of the DC reactor (FR-HEL) .....	109
2.11	Wiring for use of the CC-Link IE Field Network (FR-A800-GF) .....	110
<hr/>		
2.11.1	System configuration example .....	110
2.11.2	Network configuration .....	110
2.11.3	Network components .....	110
2.11.4	Component names of the CC-Link IE Field Network communication circuit board .....	111
2.11.5	Wiring method .....	112
2.11.6	Operation status LEDs .....	113

## **Chapter 3 PRECAUTIONS FOR USE OF THE INVERTER . . . . 116**

---

3.1	Electro-magnetic interference (EMI) and leakage currents .....	116
<hr/>		
3.1.1	Leakage currents and countermeasures .....	116
3.1.2	Techniques and measures for electromagnetic compatibility (EMC) .....	118
3.1.3	Built-in EMC filter .....	120
3.2	Power supply harmonics .....	123
<hr/>		
3.2.1	Power supply harmonics .....	123
3.2.2	Harmonic suppression guidelines in Japan .....	123
3.3	Installation of a reactor .....	127
<hr/>		
3.4	Power shutdown and magnetic contactor (MC) .....	128
<hr/>		
3.5	Countermeasures against deterioration of the 400 V class motor insulation .....	130
<hr/>		
3.6	Checklist before starting operation .....	131
<hr/>		
3.7	Failsafe system which uses the inverter .....	134

## **Chapter 4 BASIC OPERATION . . . . . 138**

---

4.1	Operation panel (FR-DU08) .....	138
<hr/>		
4.1.1	Components of the operation panel (FR-DU08) .....	138
4.1.2	Basic operation of the operation panel .....	140
4.1.3	Digital characters and their corresponding printed equivalents .....	141
4.1.4	Changing the parameter setting value .....	142
4.2	Monitoring the inverter .....	143
<hr/>		
4.2.1	Monitoring of output current and output voltage .....	143

4.2.2	First priority monitor screen. . . . .	143
4.2.3	Displaying the set frequency. . . . .	143
4.3	Easy setting of the inverter operation mode . . . . .	144
<hr/>		
4.4	Frequently-used parameters (simple mode parameters). . . . .	146
<hr/>		
4.4.1	Simple mode parameter list . . . . .	146
4.5	Basic operation procedure (PU operation) . . . . .	149
<hr/>		
4.5.1	Setting the frequency on the operation panel (example: operating at 30 Hz). . . . .	149
4.5.2	Perform PU operation using the setting dial like a potentiometer . . . . .	150
4.5.3	Setting the frequency with switches (multi-speed setting) . . . . .	151
4.5.4	Setting the frequency using an analog signal (voltage input) . . . . .	152
4.5.5	Setting the frequency using an analog signal (current input) . . . . .	153
4.6	Basic operation procedure (External operation) . . . . .	155
<hr/>		
4.6.1	Setting the frequency on the operation panel . . . . .	155
4.6.2	Setting the frequency and giving a start command with switches (multi-speed setting) (Pr.4 to Pr.6) . . . . .	156
4.6.3	Setting the frequency using an analog signal (voltage input) . . . . .	157
4.6.4	Changing the frequency (60 Hz, initial value) at the maximum voltage input (5 V, initial value). . . . .	159
4.6.5	Setting the frequency using an analog signal (current input) . . . . .	160
4.6.6	Changing the frequency (60 Hz, initial value) at the maximum current input (at 20 mA, initial value) . . . . .	161
4.7	Basic operation procedure (JOG operation) . . . . .	162
<hr/>		
4.7.1	Giving a start command by using external signals for JOG operation . . . . .	162
4.7.2	Giving a start command from the operation panel for JOG operation. . . . .	163
<hr/>		
<b>Chapter 5</b>	<b>PARAMETERS . . . . .</b>	<b>166</b>
<hr/>		
5.1	Parameter list. . . . .	166
<hr/>		
5.1.1	Parameter list (by parameter number) . . . . .	166
5.1.2	Use of a function group number for the identification of parameters . . . . .	201
5.1.3	Parameter list (by function group number) . . . . .	203
5.2	Control method . . . . .	216
<hr/>		
5.2.1	Vector control and Real sensorless vector control . . . . .	218
5.2.2	Changing the control method and mode. . . . .	221
5.2.3	Selecting the Advanced magnetic flux vector control . . . . .	228
5.2.4	Selecting the PM sensorless vector control . . . . .	230
5.2.5	Low-speed range torque characteristics . . . . .	233
5.3	Speed control under Real sensorless vector control, vector control, PM sensorless vector control . . . . .	235
<hr/>		
5.3.1	Setting procedure of Real sensorless vector control (speed control) . . . . .	240
5.3.2	Setting procedure of Vector control (speed control) . . . . .	242
5.3.3	Setting procedure of PM sensorless vector control (speed control) . . . . .	244
5.3.4	Setting the torque limit level . . . . .	245
5.3.5	Performing high-accuracy, fast-response control (gain adjustment for Real sensorless vector control, Vector control, and PM sensorless vector control) . . . . .	254
5.3.6	Troubleshooting in the speed control . . . . .	261
5.3.7	Speed feed forward control, model adaptive speed control . . . . .	263
5.3.8	Torque bias . . . . .	265
5.3.9	Avoiding motor overrunning . . . . .	269
5.3.10	Notch filter. . . . .	271
5.4	Torque control under Real sensorless vector control and Vector control . . . . .	272
<hr/>		
5.4.1	Torque control. . . . .	272



5.4.2	Setting procedure of Real sensorless vector control (torque control) . . . . .	280
5.4.3	Setting procedure for Vector control (torque control) . . . . .	282
5.4.4	Torque command . . . . .	283
5.4.5	Speed limit . . . . .	287
5.4.6	Torque control gain adjustment . . . . .	294
5.4.7	Troubleshooting in torque control . . . . .	295
5.4.8	Torque control by variable-current limiter control . . . . .	296
<b>5.5</b>	<b>Position control under vector control and PM sensorless vector control . . . . .</b>	<b>298</b>
5.5.1	About position control . . . . .	298
5.5.2	Setting procedure of Vector control (position control) . . . . .	300
5.5.3	Setting procedure of PM sensorless vector control (position control) . . . . .	302
5.5.4	Simple positioning function by parameters . . . . .	303
5.5.5	Position control by the FR-A8AL pulse train input . . . . .	316
5.5.6	Position control by pulse train input to the inverter . . . . .	319
5.5.7	Clear signal selection . . . . .	320
5.5.8	Pulse monitor . . . . .	321
5.5.9	Electronic gear settings . . . . .	325
5.5.10	Position adjustment parameter settings . . . . .	327
5.5.11	Position control gain adjustment . . . . .	328
5.5.12	Troubleshooting in position control . . . . .	329
<b>5.6</b>	<b>Adjustment during Real sensorless vector control, Vector control, PM sensorless vector control . . . . .</b>	<b>332</b>
5.6.1	Speed detection filter and torque detection filter . . . . .	332
5.6.2	Excitation ratio . . . . .	332
5.6.3	Gain adjustment of current controllers for the d axis and the q axis . . . . .	333
<b>5.7</b>	<b>(E) Environment setting parameters . . . . .</b>	<b>334</b>
5.7.1	Real time clock function . . . . .	334
5.7.2	Reset selection / disconnected PU detection / PU stop selection . . . . .	336
5.7.3	PU display language selection . . . . .	339
5.7.4	Buzzer control . . . . .	340
5.7.5	PU contrast adjustment . . . . .	340
5.7.6	Display-off setting . . . . .	340
5.7.7	Direct setting . . . . .	340
5.7.8	Resetting USB host errors . . . . .	341
5.7.9	Easy frequency setting (Volume-knob-like setting) and key lock function selection . . . . .	341
5.7.10	Frequency change increment amount setting . . . . .	342
5.7.11	Multiple rating setting . . . . .	343
5.7.12	Using the power supply exceeding 480 VAC . . . . .	345
5.7.13	Parameter write selection . . . . .	345
5.7.14	Password . . . . .	348
5.7.15	Free parameter . . . . .	350
5.7.16	Setting multiple parameters by batch . . . . .	350
5.7.17	Extended parameter display and user group function . . . . .	354
5.7.18	PWM carrier frequency and Soft-PWM control . . . . .	356
5.7.19	Inverter parts life display . . . . .	359
5.7.20	Maintenance timer alarm . . . . .	363
5.7.21	Current average value monitor signal . . . . .	363
<b>5.8</b>	<b>(F) Setting of acceleration/deceleration time and acceleration/deceleration pattern . . . . .</b>	<b>367</b>
5.8.1	Setting the acceleration and deceleration time . . . . .	367
5.8.2	Acceleration/deceleration pattern . . . . .	372
5.8.3	Remote setting function . . . . .	377
5.8.4	Starting frequency and start-time hold function . . . . .	381
5.8.5	Minimum motor speed frequency and hold function at the motor start up . . . . .	382
5.8.6	Shortest acceleration/deceleration and optimum acceleration/deceleration (automatic acceleration/deceleration) . . . . .	384
5.8.7	Lift operation (automatic acceleration/deceleration) . . . . .	387
<b>5.9</b>	<b>(D) Operation command and frequency command . . . . .</b>	<b>389</b>
5.9.1	Operation mode selection . . . . .	389
5.9.2	Startup of the inverter in Network operation mode at power-ON . . . . .	398

5.9.3	Start command source and frequency command source during communication operation	400
5.9.4	Reverse rotation prevention selection	406
5.9.5	Frequency setting using pulse train input	406
5.9.6	JOG operation	410
5.9.7	Operation by multi-speed setting	411
<b>5.10</b>	<b>(H) Protective function parameter</b>	<b>415</b>
5.10.1	Motor overheat protection (electronic thermal O/L relay)	415
5.10.2	Fault definition	422
5.10.3	Cooling fan operation selection	423
5.10.4	Earth (ground) fault detection at start	425
5.10.5	Varying the activation level of the undervoltage protective function	425
5.10.6	Initiating a protective function	425
5.10.7	I/O phase loss protection selection	426
5.10.8	Retry function	426
5.10.9	Limiting the output frequency (maximum/minimum frequency)	428
5.10.10	Avoiding machine resonance points (frequency jump)	429
5.10.11	Stall prevention operation	431
5.10.12	Load characteristics fault detection	439
5.10.13	Motor overspeeding detection	443
<b>5.11</b>	<b>(M) Item and output signal for monitoring</b>	<b>444</b>
5.11.1	Speed indication and its setting change to rotations per minute	444
5.11.2	Monitor item selection on operation panel or via communication	446
5.11.3	Monitor display selection for terminals FM/CA and AM	457
5.11.4	Adjustment of terminal FM/CA and terminal AM	463
5.11.5	Energy saving monitoring	467
5.11.6	Output terminal function selection	473
5.11.7	Output frequency detection	484
5.11.8	Output current detection function	487
5.11.9	Output torque detection function	488
5.11.10	Remote output function	489
5.11.11	Analog remote output function	490
5.11.12	Fault code output selection	492
5.11.13	Pulse train output to announce cumulative output energy	493
5.11.14	Detection of control circuit temperature	494
5.11.15	Encoder pulse dividing output	495
<b>5.12</b>	<b>(T) Multi-function input terminal parameters</b>	<b>496</b>
5.12.1	Analog input selection	496
5.12.2	Analog input terminal (terminal 1, 4) function assignment	500
5.12.3	Analog input compensation	501
5.12.4	Response level of analog input and noise elimination	503
5.12.5	Frequency setting voltage (current) bias and gain	505
5.12.6	Torque (magnetic flux) setting voltage (current) bias and gain	510
5.12.7	Checking of current input on analog input terminal	517
5.12.8	Input terminal function selection	521
5.12.9	Inverter output shutoff	524
5.12.10	External fault input signal	525
5.12.11	Selecting the condition to activate the Second function selection (RT) signal or the Third function selection (X9) signal	525
<b>5.13</b>	<b>(C) Motor constant parameters</b>	<b>528</b>
5.13.1	Applied motor	528
5.13.2	Offline auto tuning for an induction motor	532
5.13.3	Offline auto tuning for a PM motor (under Vector control)	542
5.13.4	Offline auto tuning for a PM motor (motor constant tuning)	551
5.13.5	Online auto tuning	558
5.13.6	Signal loss detection of encoder signals	561
<b>5.14</b>	<b>(A) Application parameters</b>	<b>562</b>
5.14.1	Electronic bypass function	563
5.14.2	Self power management	569
5.14.3	Brake sequence function	572
5.14.4	Start count monitor	576

5.14.5	Stop-on-contact control	577
5.14.6	Load torque high-speed frequency control	580
5.14.7	Traverse function	582
5.14.8	Anti-sway control	584
5.14.9	Orientation control	585
5.14.10	PID control	601
5.14.11	Changing the display increment of numerical values used in PID control	615
5.14.12	PID Pre-charge function	618
5.14.13	Dancer control	622
5.14.14	Automatic restart after instantaneous power failure/flying start with an induction motor	628
5.14.15	Automatic restart after instantaneous power failure/flying start with a PM motor	635
5.14.16	Offline auto tuning for a frequency search	638
5.14.17	Power failure time deceleration-to-stop function	642
5.14.18	PLC function	646
5.14.19	Trace function	649
<b>5.15</b>	<b>(N) Communication operation parameters</b>	<b>659</b>
<hr/>		
5.15.1	Wiring and configuration of PU connector	659
5.15.2	Wiring and configuration of RS-485 terminals	661
5.15.3	Initial setting of operation via communication	663
5.15.4	Initial settings and specifications of RS-485 communication	670
5.15.5	Mitsubishi inverter protocol (computer link communication)	672
5.15.6	MODBUS RTU communication specification	686
5.15.7	CC-Link IE Field Network function setting (FR-A800-GF)	699
5.15.8	USB device communication	701
5.15.9	Automatic connection with GOT	701
5.15.10	Backup/restore	702
<b>5.16</b>	<b>(G) Control parameters</b>	<b>705</b>
<hr/>		
5.16.1	Manual torque boost	706
5.16.2	Base frequency voltage	707
5.16.3	Load pattern selection	708
5.16.4	Excitation current low-speed scaling factor	711
5.16.5	Energy saving control	712
5.16.6	Adjustable 5 points V/F	713
5.16.7	SF-PR slip amount adjustment mode	714
5.16.8	DC injection brake, zero speed control, and servo lock	715
5.16.9	Output stop function	720
5.16.10	Start signal operation selection / stop selection	722
5.16.11	Regenerative brake selection and DC feeding mode	724
5.16.12	Regeneration avoidance function	732
5.16.13	Increased magnetic excitation deceleration	735
5.16.14	Slip compensation	736
5.16.15	Encoder feedback control	736
5.16.16	Droop control	738
5.16.17	Speed smoothing control	741
<b>5.17</b>	<b>Parameter clear / All parameter clear</b>	<b>743</b>
<hr/>		
<b>5.18</b>	<b>Copying and verifying parameters on the operation panel</b>	<b>744</b>
<hr/>		
5.18.1	Parameter copy	744
5.18.2	Parameter verification	746
<b>5.19</b>	<b>Copying and verifying parameters using a USB memory</b>	<b>747</b>
<hr/>		
<b>5.20</b>	<b>Checking parameters changed from their initial values (initial value change list)</b>	<b>751</b>
<hr/>		
<b>5.21</b>	<b>CC-Link IE Field Network (FR-A800-GF)</b>	<b>752</b>
<hr/>		
5.21.1	Cyclic transmission	752
5.21.2	I/O signal list	753
5.21.3	Details of the remote input and output signals	756
5.21.4	Details of the remote register	758

5.21.5	Programming examples	763
5.21.6	Instructions	770
5.21.7	Troubleshooting	770

## **Chapter 6 PROTECTIVE FUNCTIONS . . . . . 772**

6.1	Inverter fault and alarm indications	772
6.2	Reset method for the protective functions	773
6.3	Check and clear of the fault history	774
6.4	List of fault displays	776
6.5	Causes and corrective actions	779
6.6	Check first when you have a trouble	800
6.6.1	Motor does not start	800
6.6.2	Motor or machine is making abnormal acoustic noise	803
6.6.3	Inverter generates abnormal noise	803
6.6.4	Motor generates heat abnormally	804
6.6.5	Motor rotates in the opposite direction	804
6.6.6	Speed greatly differs from the setting	804
6.6.7	Acceleration/deceleration is not smooth	805
6.6.8	Speed varies during operation	806
6.6.9	Operation mode is not changed properly	807
6.6.10	Operation panel (FR-DU08) display is not operating	807
6.6.11	The motor current is too large	807
6.6.12	Speed does not accelerate	808
6.6.13	Unable to write parameter setting	809
6.6.14	Power lamp is not lit	809

## **Chapter 7 PRECAUTIONS FOR MAINTENANCE AND INSPECTION. . . . . 812**

7.1	Inspection item	812
7.1.1	Daily inspection	812
7.1.2	Periodic inspection	812
7.1.3	Daily and periodic inspection	813
7.1.4	Checking the inverter and converter modules	814
7.1.5	Cleaning	815
7.1.6	Replacement of parts	815
7.1.7	Removal and reinstallation of the control circuit terminal block	819
7.2	Measurement of main circuit voltages, currents, and powers	821
7.2.1	Measurement of powers	823
7.2.2	Measurement of voltages	823
7.2.3	Measurement of currents	823
7.2.4	Measurement of inverter input power factor	823
7.2.5	Measurement of converter output voltage (between terminals P and N)	823
7.2.6	Measurement of inverter output frequency	823
7.2.7	Insulation resistance test using megger	824
7.2.8	Withstand voltage test	824

## **Chapter 8 SPECIFICATIONS . . . . . 826**

---

8.1	Inverter rating . . . . .	826
8.2	Motor rating . . . . .	829
8.2.1	Vector control dedicated motor SF-V5RU (1500 r/min series) . . . . .	829
8.2.2	Vector control dedicated motor SF-THY . . . . .	832
8.2.3	IPM motor MM-CF (2000 r/min series) . . . . .	833
8.3	Common specifications . . . . .	835
8.4	Outline dimension drawings . . . . .	837
8.4.1	Inverter outline dimension drawings . . . . .	837
8.4.2	Dedicated motor outline dimension drawings . . . . .	845

---

## **Chapter 9 APPENDIX . . . . . 856**

---

9.1	For customers replacing the conventional model with this inverter . . . . .	856
9.1.1	Replacement of the FR-A700 series . . . . .	856
9.1.2	Replacement of the FR-A500(L) series . . . . .	857
9.2	International standards . . . . .	858
9.3	Acquisition of type certification for ship classification standards (400 V class) . . . . .	858
9.3.1	Applicable models . . . . .	858
9.3.2	Details of type certification for standard model / Separated converter type . . . . .	858
9.3.3	Details of type certification for IP55 compatible model . . . . .	860
9.3.4	Wiring for compliance with EMC standards . . . . .	862
9.4	Specification comparison between PM sensorless vector control and induction motor control . . . . .	863
9.5	Parameters (functions) and instruction codes under different control methods . . . . .	864
9.6	For customers using HMS network options . . . . .	893
9.7	Ready bit status selection (Pr.349, N240) . . . . .	897

---

# Safety instructions

---

Thank you for choosing Mitsubishi Electric inverter.

This Instruction Manual (Detailed) provides detailed instructions for advanced settings of the FR-A800 series inverters.

Incorrect handling might cause an unexpected fault. Before using this product, read all the relevant instruction manuals carefully to ensure proper use.

Do not attempt to install, operate, maintain or inspect this product until you have read the Instruction Manuals and appended documents carefully. Do not use this product until you have a full knowledge of this product mechanism, safety information and instructions.

Installation, operation, maintenance and inspection must be performed by qualified personnel. Here, qualified personnel means a person who meets all the following conditions:

- A person who possesses a certification in regard with electric appliance handling, or person took a proper engineering training. Such training may be available at your local Mitsubishi Electric office. Contact your local sales office for schedules and locations.
- A person who can access operating manuals for the protective devices (for example, light curtain) connected to the safety control system, or a person who has read these manuals thoroughly and familiarized themselves with the protective devices.

In this Instruction Manual, the safety instruction levels are classified into "WARNING" and "CAUTION".



**WARNING**

Incorrect handling may cause hazardous conditions, resulting in death or severe injury.



**CAUTION**

Incorrect handling may cause hazardous conditions, resulting in medium or slight injury, or may cause only material damage.

Note that even the  **CAUTION** level may lead to a serious consequence depending on conditions. Be sure to follow the instructions of both levels as they are critical to personnel safety.

## ◆ Electric shock prevention

### WARNING

- Do not remove the front cover or the wiring cover while the power of this product is ON, and do not run this product with the front cover or the wiring cover removed as the exposed high voltage terminals or the charging part of the circuitry can be touched. Doing so may cause an electric shock.
- Even if power is OFF, do not remove the front cover except for wiring or periodic inspection as the inside of this product is charged. Doing so may cause an electric shock.
- Before wiring or inspection, check that the LED display of the operation panel is OFF. Any person who is involved in wiring or inspection shall wait for 10 minutes or longer after the power supply has been cut off, and check that there are no residual voltage using a digital multimeter or the like. The capacitor is charged with high voltage for some time after power OFF, and it is dangerous.
- This product must be earthed (grounded). Earthing (grounding) must conform to the requirements of national and local safety regulations and electrical code (NEC section 250, IEC 61140 class 1 and other applicable standards). A neutral-point earthed (grounded) power supply must be used for 400 V class of this product to be compliant with EN standard.
- Any person who is involved in wiring or inspection of this product shall be fully competent to do the work.
- This product body must be installed before wiring. Otherwise you may get an electric shock or be injured.
- Do not touch the setting dial or keys with wet hands. Doing so may cause an electric shock.
- Do not subject the cables to scratches, excessive stress, heavy loads or pinching. Doing so may cause an electric shock.
- Do not change the cooling fan while power is ON as it is dangerous.
- Do not touch the printed circuit board or handle the cables with wet hands. Doing so may cause an electric shock.
- Never touch the motor terminals, etc. right after powering OFF as the DC voltage is applied to the motor for 1 second at powering OFF if the main circuit capacitor capacity is measured. Doing so may cause an electric shock.
- Before wiring or inspection for a PM motor, confirm that the PM motor is stopped as a PM motor is a synchronous motor with high-performance magnets embedded inside and high-voltage is generated at the motor terminals while the motor is running even after the power of this product is turned OFF. In an application, such as fan and blower, that the motor may be driven by the load, connect a low-voltage manual contactor at the output side of this product and keep it open during wiring and inspection of this product. Otherwise you may get an electric shock.

## ◆ Fire prevention

### CAUTION

- This product must be installed on a nonflammable wall without holes in it so that its components cannot be touched from behind. Installing it on or near flammable material may cause a fire.
- If this product becomes faulty, the product power must be switched OFF. A continuous flow of large current may cause a fire.
- When using a brake resistor, a sequence that will turn OFF power when a fault signal is output must be configured. Otherwise the brake resistor may excessively overheat due to damage of the brake transistor and such, causing a fire.
- Do not connect a resistor directly to the DC terminals P/+ and N/-. Doing so could cause a fire.
- Be sure to perform daily and periodic inspections as specified in the Instruction Manual. There is a possibility of explosion, damage, or fire if this product is used without inspection.

## ◆ Injury prevention

### CAUTION

- The voltage applied to each terminal must be as specified in the Instruction Manual. Otherwise an explosion or damage may occur.
- The cables must be connected to the correct terminals. Otherwise an explosion or damage may occur.
- The polarity (+ and -) must be correct. Otherwise an explosion or damage may occur.
- While power is ON or for some time after power-OFF, do not touch this product as it will be extremely hot. Doing so may cause burns.

## ◆ Additional instructions

The following instructions must be also followed. If this product is handled incorrectly, it may cause unexpected fault, an injury, or an electric shock.

---

### CAUTION

---

#### Transportation and installation

- To prevent injury, wear cut-resistant gloves when opening packaging with sharp tools.
- Use proper lifting techniques or a trolley when carrying products. Failure to do so may lead to injuries.
- Do not stand or place any heavy object on this product.
- Do not stack the boxes containing this product higher than the number recommended.
- When carrying this product, do not hold it by the front cover. It may fall or break.
- During installation, caution must be taken not to drop this product as doing so may cause injuries.
- The product must be installed on a surface that withstands the weight of the product.
- Do not install this product on a hot surface.
- Ensure the mounting orientation of this product is correct.
- Ensure this product is mounted securely in its enclosure.
- Do not install or operate this product if it is damaged or has parts missing.
- Foreign conductive objects must be prevented from entering this product. That includes screws and metal fragments or other flammable substance such as oil.
- As this product is a precision instrument, do not drop or subject it to impact.
- The surrounding air temperature must be between  $-10$  and  $+50^{\circ}\text{C}^{*1}$  (non-freezing) for this product at HD (heavy duty), ND (normal duty) (initial setting), or LD (light duty) rating, and between  $-10$  and  $+40^{\circ}\text{C}^{*2}$  (non-freezing) for this product at SLD (super light duty) rating. Otherwise the product may be damaged.
- The ambient humidity must be 95% RH or less (non-condensing) for this product. Otherwise the product may be damaged. (Refer to [page 37](#) for details.)
- The temporary storage temperature (applicable to a short limited time such as a transportation time) must be between  $-20$  and  $+65^{\circ}\text{C}$ . Otherwise this product may be damaged.
- This product must be used indoors (without corrosive gas, flammable gas, oil mist, dust and dirt). Otherwise the product may be damaged.
- Do not use this product at an altitude above 2500 m. Vibration should not exceed  $5.9\text{ m/s}^{2*3}$  at 10 to 55 Hz in X, Y, and Z directions. Otherwise the product may be damaged. (For details, refer to [page 37](#).)
- If halogens (including fluorine, chlorine, bromine, and iodine) contained in fumigants for wood packages enter this product, the product may be damaged. Prevent the entry of fumigant residuals or use an alternative method such as heat disinfection. Note that sterilization of disinfection of wood packages should be performed before packing the product.

#### Wiring

- Do not install a power factor correction capacitor, surge absorber, or radio noise filter on the output side of this product. These devices may overheat or burn out.
- The output terminals (terminals U, V, and W) must be connected to a motor correctly. Otherwise the motor will rotate inversely.
- Even with the power OFF, high voltage is still applied to the terminals U, V and W while the PM motor is running. Ensure the PM motor has stopped before carrying out any wiring. Otherwise you may get an electric shock.
- Never connect a PM motor to a commercial power supply. Connecting a commercial power supply to the input terminals (U, V, W) of a PM motor will burn it out. The PM motor must be applied a power from this product with the output terminals (U, V, W).

#### Test operation

- Before starting the test operation, confirm or adjust the parameter settings. Failure to do so may cause some machines to make unexpected motions.

---

\*1 0 to  $+50^{\circ}\text{C}$  for the FR-A800-GF.

\*2 0 to  $40^{\circ}\text{C}$  for the FR-A800-GF.

\*3  $2.9\text{ m/s}^2$  or less for the FR-A840-04320(160K) or higher.



---

 **WARNING**

---

**Usage**

- Stay away from the equipment after using the retry function in this product as the equipment will restart suddenly after the output shutoff of this product.
  - Depending on the function settings of this product, the product does not stop its output even when the STOP/RESET key on the operation panel is pressed. To prepare for it, provide a separate circuit and switch (to turn OFF the power of this product, or apply a mechanical brake, etc.) for an emergency stop.
  - Be sure to turn OFF the start (STF/STR) signal before clearing the fault as this product will restart the motor suddenly after a fault is cleared.
  - Do not use a PM motor for an application that the motor may be driven by the load and run at a speed higher than the maximum motor speed.
  - Use only a three-phase induction motor or PM motor as a load on this product. Connection of any other electrical equipment to the output of this product may damage the equipment.
  - Performing pre-excitation (by using the LX or X13 signal) during torque control (under Real sensorless vector control) may rotate a motor at a low speed even though a start command (STF or STR) is not given. This product with the start command ON may also rotate the motor at a low speed when the speed limit value is set to zero. Confirm that the motor running does not cause any safety problems before performing pre-excitation.
  - Do not modify this product.
  - Do not remove any part which is not instructed to be removed in the Instruction Manuals. Doing so may lead to a failure or damage of this product.
-

---

## CAUTION

---

### Usage

- The electronic thermal O/L relay function may not be enough for protection of a motor from overheating. It is recommended to install an external thermal relay or a PTC thermistor for overheat protection.
- Do not repeatedly start or stop this product with a magnetic contactor on its input side. Doing so may shorten the life of this product.
- Use a noise filter or other means to minimize electromagnetic interference with other electronic equipment used nearby this product.
- Appropriate precautions must be taken to suppress harmonics. Otherwise harmonics in power systems generated from this product may heat/damage a power factor correction capacitor or a generator.
- To drive a 400 V class motor with this product, use an insulation-enhanced motor, or take measures to suppress surge voltage. Otherwise surge voltage, which is attributed to the length and thickness of wire, may occur at the motor terminals, causing the motor insulation to deteriorate.
- As all parameters return to their initial values after the Parameter clear or All parameter clear is performed, the needed parameters for this product operation must be set again before the operation is started.
- This product can be easily set for high-speed operation. Therefore, consider all things related to the operation such as the performance of a motor and equipment in a system before the setting change.
- This product's brake function cannot be used as a mechanical brake. Use a separate device instead.
- Perform an inspection and test operation of this product if it has been stored for a long period of time.
- To avoid damage to this product due to static electricity, static electricity in your body must be discharged before you touch this product.
- Only one PM motor can be connected to a single unit of this product.
- A PM motor must be used under PM sensorless vector control. Do not use a synchronous motor, induction motor, or synchronous induction motor.
- Do not connect a PM motor to this product with it set to the induction motor control setting (initial setting). Do not connect an induction motor to this product with it set to the PM sensorless vector control setting. Doing so will cause failure.
- As a process of starting a PM motor, turn ON the power of this product first, and then close the contactor on the output side of this product.
- To maintain the security (confidentiality, integrity, and availability) of the inverter and the system against unauthorized access, DoS<sup>\*1</sup> attacks, computer viruses, and other cyberattacks from external devices via network, take appropriate measures such as firewalls, virtual private networks (VPNs), and antivirus solutions. We shall have no responsibility or liability for any problems involving inverter trouble and system trouble by DoS attacks, unauthorized access, computer viruses, and other cyberattacks.

### Emergency stop

- A safety backup such as an emergency brake must be provided for devices or equipment in a system to prevent hazardous conditions in case of failure of this product or an external device controlling this product.
- If the breaker installed on the input side of this product trips, check for wiring faults (such as short circuits) and damage to internal parts of this product. Identify and remove the cause of the trip before resetting the tripped breaker (or before applying the power to this product again).
- When any protective function is activated, take an appropriate corrective action before resetting this product to resume the operation.

### Maintenance, inspection and parts replacement

- Do not carry out a megger (insulation resistance) test on the control circuit of this product. Doing so will cause failure.

### Disposal

- This product must be treated as industrial waste.

---

\*1 DoS: A denial-of-service (DoS) attack disrupts services by overloading systems or exploiting vulnerabilities, resulting in a denial-of-service (DoS) state.

---

## General instruction

---

- For clarity, illustrations in this Instruction Manual may be drawn with covers or safety guards removed. Ensure all covers and safety guards are properly installed prior to starting operation. For details on the PM motor, refer to the Instruction Manual of the PM motor.
-

# CHAPTER 1 INTRODUCTION

1.1	Product checking and accessories .....	17
1.2	Component names .....	19
1.3	Operation steps .....	21
1.4	Related manuals .....	23

# 1 INTRODUCTION

The contents described in this chapter must be read before using this product.

Always read the instructions before use.

For the separated converter type, refer to the "INTRODUCTION" in the FR-A802 (Separated Converter Type) Instruction Manual (Hardware).

For the IP55 compatible model, refer to the "INTRODUCTION" in the FR-A806 (IP55/UL Type 12 specification) Instruction Manual (Hardware).

## ◆ Abbreviations

Item	Description
DU	Operation panel (FR-DU08)
Operation panel	Operation panel (FR-DU08) and LCD operation panel (FR-LU08)
Parameter unit	Parameter unit (FR-PU07)
PU	Operation panel and parameter unit
Inverter	Mitsubishi Electric FR-A800 series inverter
FR-A800-GF	FR-A800 series inverter with built-in CC-Link IE Field Network communication function
Vector control compatible option	FR-A8AP/FR-A8AL/FR-A8APA/FR-A8APR/FR-A8APS (plug-in option), FR-A8TP (control terminal option)
Pr.	Parameter number (Number assigned to function)
PU operation	Operation using the PU (operation panel/parameter unit)
External operation	Operation using the control circuit signals
Combined operation	Combined operation using the PU (operation panel/parameter unit) and External operation
Mitsubishi Electric standard motor	SF-JR
Mitsubishi Electric constant-torque motor	SF-HRCA
Vector control dedicated motor	SF-V5RU
Mitsubishi Electric IPM motor	MM-CF

## ◆ Trademarks

- Microsoft and Visual C++ are registered trademarks of Microsoft Corporation in the United States and other countries.
- Ethernet is a registered trademark of Fuji Xerox Corporation in Japan.
- MODBUS is a registered trademark of SCHNEIDER ELECTRIC USA, INC.
- PROFIBUS and Profibus-DP are trademarks of PROFIBUS & PROFINET International.
- Other company and product names herein are the trademarks and registered trademarks of their respective owners.

## ◆ Notes on descriptions in this Instruction Manual

- Connection diagrams in this Instruction Manual appear with the control logic of the input terminals as sink logic, unless otherwise specified. (For the control logic, refer to [page 72](#).)

## ◆ Harmonic Suppression Guidelines

All the models of the inverters used by specific consumers are covered by "the Harmonic Suppression Guidelines for Consumers Who Receive High Voltage or Special High Voltage". (For details, refer to [page 123](#).)

# 1.1 Product checking and accessories

Unpack the product and check the rating plate and the capacity plate of the inverter to ensure that the model agrees with the order and the product is intact.

## ◆ Inverter model

Symbol	Voltage class	Symbol	Structure, functionality	Symbol	Description	Symbol	Type*1
2	200 V class	0	Standard model	00023 to 12120	Inverter SLD rated current (A)	1	FM
4	400 V class	2	Separated converter type	0.4K to 500K	Inverter ND rated capacity (kW)	2	CA
		6	IP55 compatible model				

FR - A 8 2 0 - 00046 - 1 - [ ] - [ ]

Symbol	Circuit board coating*2	Plated conductor	Symbol	Function
None	Without	Without	None	Standard type
60	With	Without	GF	With built-in CC-link IE Field Network function
06*3	With	With		

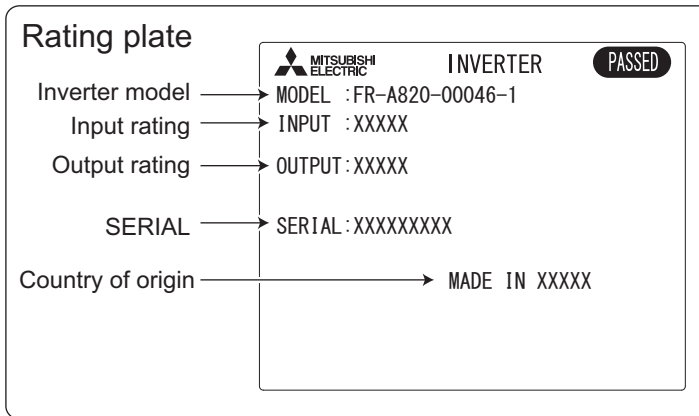
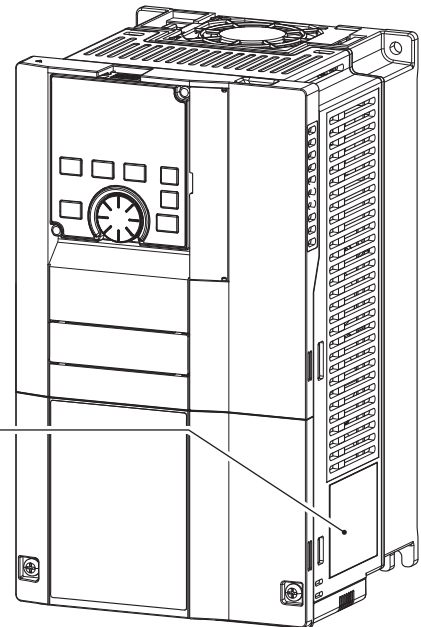

\*1 Specification differs by the type. Major differences are shown in the following table.

Type	Monitor output	Initial setting			
		Built-in EMC filter	Control logic	Rated frequency	Pr.19 Base frequency voltage
FM (terminal FM equipped model)	Terminal FM (pulse train output) Terminal AM (analog voltage output (0 to ±10 VDC))	OFF	Sink logic	60 Hz	9999 (same as the power supply voltage)
CA (terminal CA equipped model)	Terminal CA (analog current output (0 to 20 mADC)) Terminal AM (analog voltage output (0 to ±10 VDC))	ON	Source logic	50 Hz	8888 (95% of the power supply voltage)

\*2 Conforming to IEC 60721-3-3 3C2/3S2

\*3 Applicable for the FR-A820-00340(5.5K) or higher, and the FR-A840-00170(5.5K) or higher.

### NOTE

- In this Instruction Manual, the inverter model name consists of the applicable motor capacity and the rated current. (Example) FR-A820-00046(0.4K)

## ◆ Accessory

- Fan cover fixing screws

These screws are necessary for compliance with the EU Directives. (Refer to the Instruction Manual (Startup).)

Capacity	Screw size (mm)	Quantity
FR-A820-00105(1.5K) to FR-A820-00250(3.7K) FR-A840-00083(2.2K), FR-A840-00126(3.7K)	M3 × 35	1
FR-A820-00340(5.5K), FR-A820-00490(7.5K) FR-A840-00170(5.5K), FR-A840-00250(7.5K)	M3 × 35	2
FR-A820-00630(11K) to FR-A820-01250(22K) FR-A840-00310(11K) to FR-A840-00620(22K)	M4×40	2

- Eyebolt for hanging the inverter

Capacity	Eyebolt size	Quantity
FR-A840-04320(160K) to FR-A840-06830(280K)	M12	2



## ◆ How to read the SERIAL number

### Rating plate example

Symbol Year Month Control number

SERIAL

The SERIAL consists of one symbol, two characters indicating the production year and month, and six characters indicating the control number.

The last digit of the production year is indicated as the Year, and the Month is indicated by 1 to 9, X (October), Y (November), or Z (December).

# 1.2 Component names

Component names are as follows.

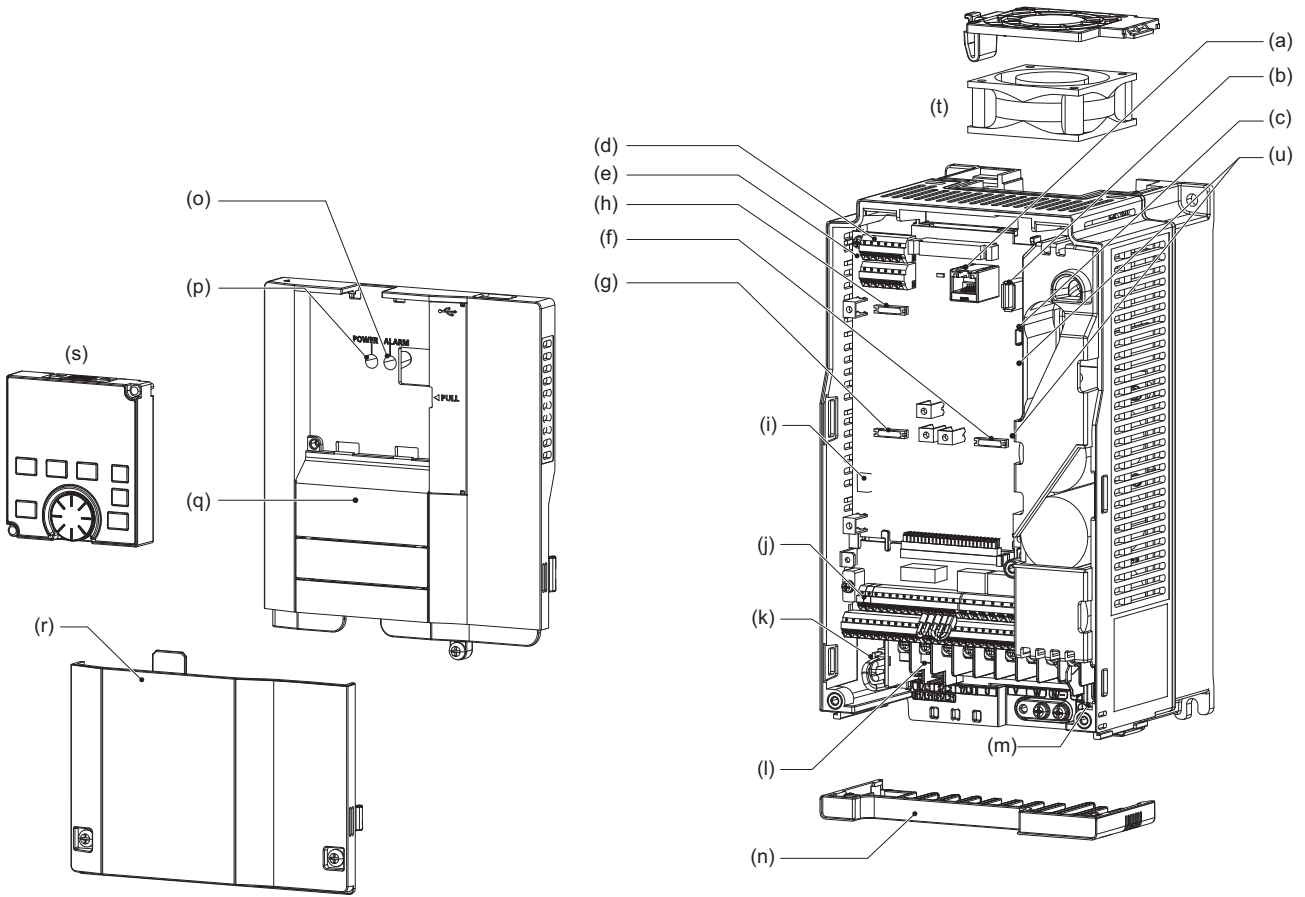



Symbol	Name	Description	Refer to page
(a)	PU connector	Connects the operation panel or the parameter unit. This connector also enables the RS-485 communication.	84
(b)	USB A connector	Connects a USB memory device.	85
(c)	USB mini B connector	Connects a personal computer and enables communication with FR Configurator2.	85
(d)	RS-485 terminals	Enables RS-485, MODBUS RTU communication.	86
(e)	Terminating resistor selection switch (SW1)	Select whether or not to use the terminating resistor for RS-485 communication.	86
(f)	Plug-in option connector 1	Connects a plug-in option or a communication option. (For the FR-A800-GF, a CC-Link IE Field Network communication circuit board is installed to the connector 1. Refer to <a href="#">page 110.</a> )	Instruction Manual of the option
(g)	Plug-in option connector 2		
(h)	Plug-in option connector 3		
(i)	Voltage/current input switches (SW2)	Selects between voltage and current for the input via terminals 2 and 4.	496
(j)	Control circuit terminal block	Connects cables for the control circuit.	68
(k)	EMC filter ON/OFF connector	Turns ON/OFF the EMC filter.	120
(l)	Main circuit terminal block	Connects cables for the main circuit.	54
(m)	Charge lamp	Stays ON while the power is supplied to the main circuit.	55
(n)	Wiring cover	This cover is removable without unplugging cables. (FR-A820-01250(22K) or lower, FR-A840-00620(22K) or lower)	57
(o)	Alarm lamp	Turns ON when the protective function of the inverter is activated.	55
(p)	Power lamp	Stays ON while the power is supplied to the control circuit (R1/L11, S1/L21).	55
(q)	Upper front cover	Remove this cover for the installation of the product, installation of a plug-in (communication) option, RS-485 terminal wiring, switching of the voltage/current input switches, etc. (The FR-A800-GF had a front cover with an LED display cover.)	33
(r)	Lower front cover	Remove this cover for wiring.	33
(s)	Operation panel (FR-DU08)	Operates and monitors the inverter.	138
(t)	Cooling fan	Cools the inverter. (FR-A820-00105(1.5K) or higher, FR-A840-00083(2.2K) or higher)	816
(u)	Switches (SW3 and SW4) for manufacturer setting	Do not change the initial setting (OFF  ).	—

# 1.3 Operation steps

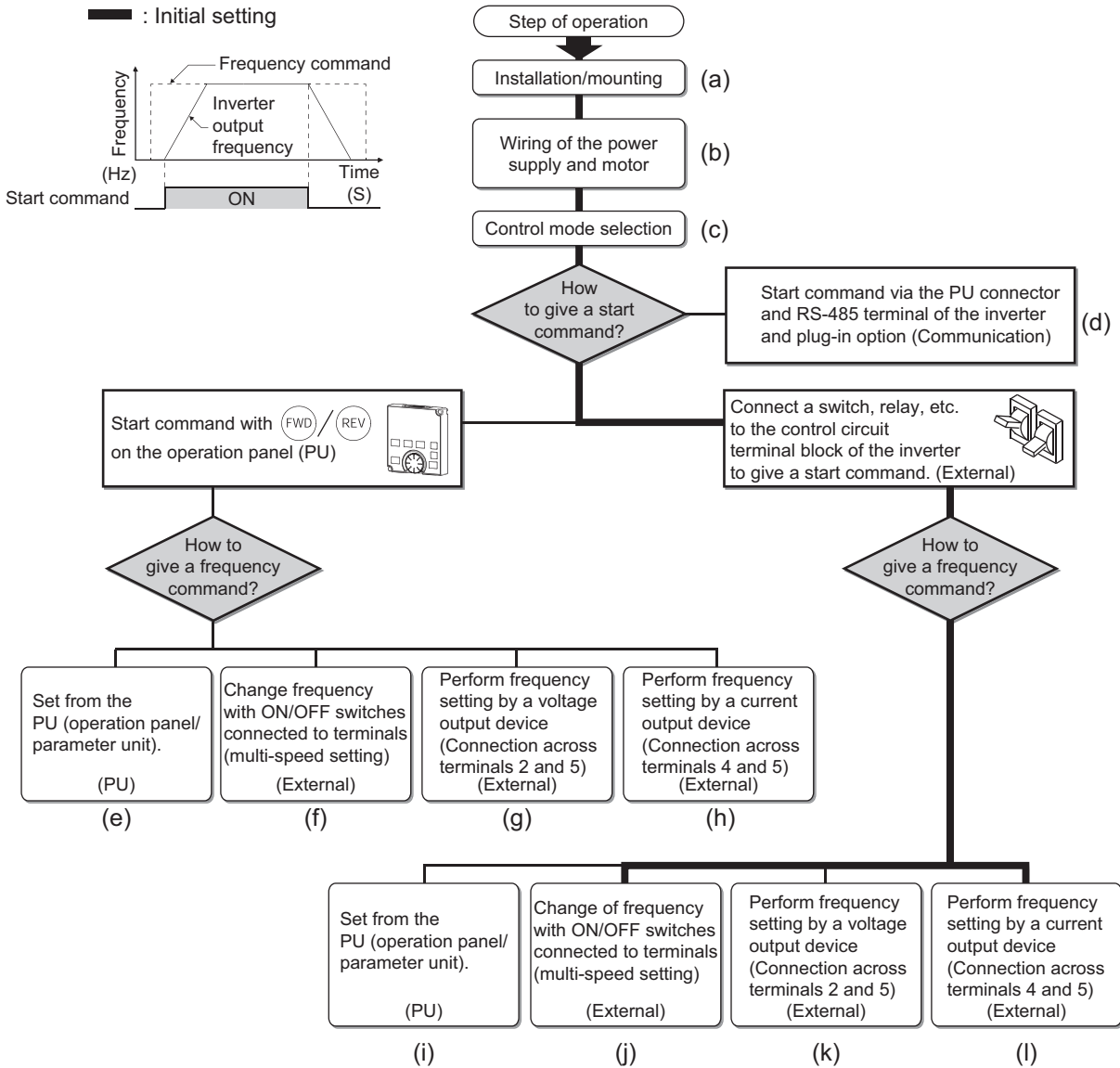

Symbol	Overview	Refer to page
(a)	Install the inverter.	37
(b)	Perform wiring for the power supply and the motor.	55
(c)	Select the control method (V/F control, Advanced magnetic flux vector control, Vector control, or PM sensorless vector control).	221
(d)	Give the start command via communication.	659
(e)	Give both the start and frequency commands from the PU. (PU operation mode)	149
(f)	Give the start command from the PU and the frequency command via terminals RH, RM, and RL. (External/PU combined operation mode 2)	151
(g)	Give the start command from the PU and the frequency command by voltage input via terminal 2. (External/PU combined operation mode 2)	152
(h)	Give the start command from the PU and the frequency command by current input via terminal 4. (External/PU combined operation mode 2)	153
(i)	Give the start command via terminal STF or STR and the frequency command from the PU. (External/PU combined operation mode 1)	155
(j)	Give the start command via terminal STF or STR and the frequency command via terminals RH, RM, and RL. (External operation mode)	156
(k)	Give the start command via terminal STF or STR and the frequency command by voltage input via terminal 2. (External operation mode)	157
(l)	Give the start command via terminal STF or STR and the frequency command by current input via terminal 4. (External operation mode)	160

# 1.4 Related manuals

Manuals related to the FR-A800 inverter are shown in the following table.

Name	Manual number
FR-A800 Instruction Manual (Startup)	IB-0600493
FR-A800-GF Instruction Manual (Startup)	IB-0600600
FR-A802 (Separated Converter Type) Instruction Manual (Hardware)	IB-0600533
FR-A802-GF (Separated Converter Type) Instruction Manual (Hardware)	IB-0600601
FR-CC2 (Converter unit) Instruction Manual	IB-0600542
FR-A806 (IP55/UL Type 12 specification) Instruction Manual (Hardware)	IB-0600531ENG
FR Configurator 2 Instruction Manual	IB-0600516ENG
FR-A800/F800 PLC Function Programming Manual	IB-0600492ENG
FR-A800/F800 Safety Stop Function Instruction Manual	BCN-A23228-001

# MEMO

# CHAPTER 2 INSTALLATION AND WIRING

2.1	Peripheral devices .....	27
2.2	Removal and reinstallation of the operation panel or the front covers.....	33
2.3	Installation of the inverter and enclosure design .....	37
2.4	Terminal connection diagrams.....	46
2.5	Main circuit terminals .....	54
2.6	Control circuit.....	68
2.7	Communication connectors and terminals.....	84
2.8	Connection to a motor with encoder (Vector control) .....	87
2.9	Parameter settings for a motor with encoder .....	94
2.10	Connection of stand-alone option units .....	97
2.11	Wiring for use of the CC-Link IE Field Network (FR-A800-GF) .....	110

# 2 INSTALLATION AND WIRING

---

This chapter explains the installation and the wiring of this product.

Always read the instructions before use.

For the separated converter type, refer to the "INSTALLATION AND WIRING" in the FR-A802 (Separated Converter Type) Instruction Manual (Hardware).

For the IP55 compatible model, refer to the "INSTALLATION AND WIRING" in the FR-A806 (IP55/UL Type 12 specification) Instruction Manual (Hardware).

# 2.1 Peripheral devices

## 2.1.1 Inverter and peripheral devices

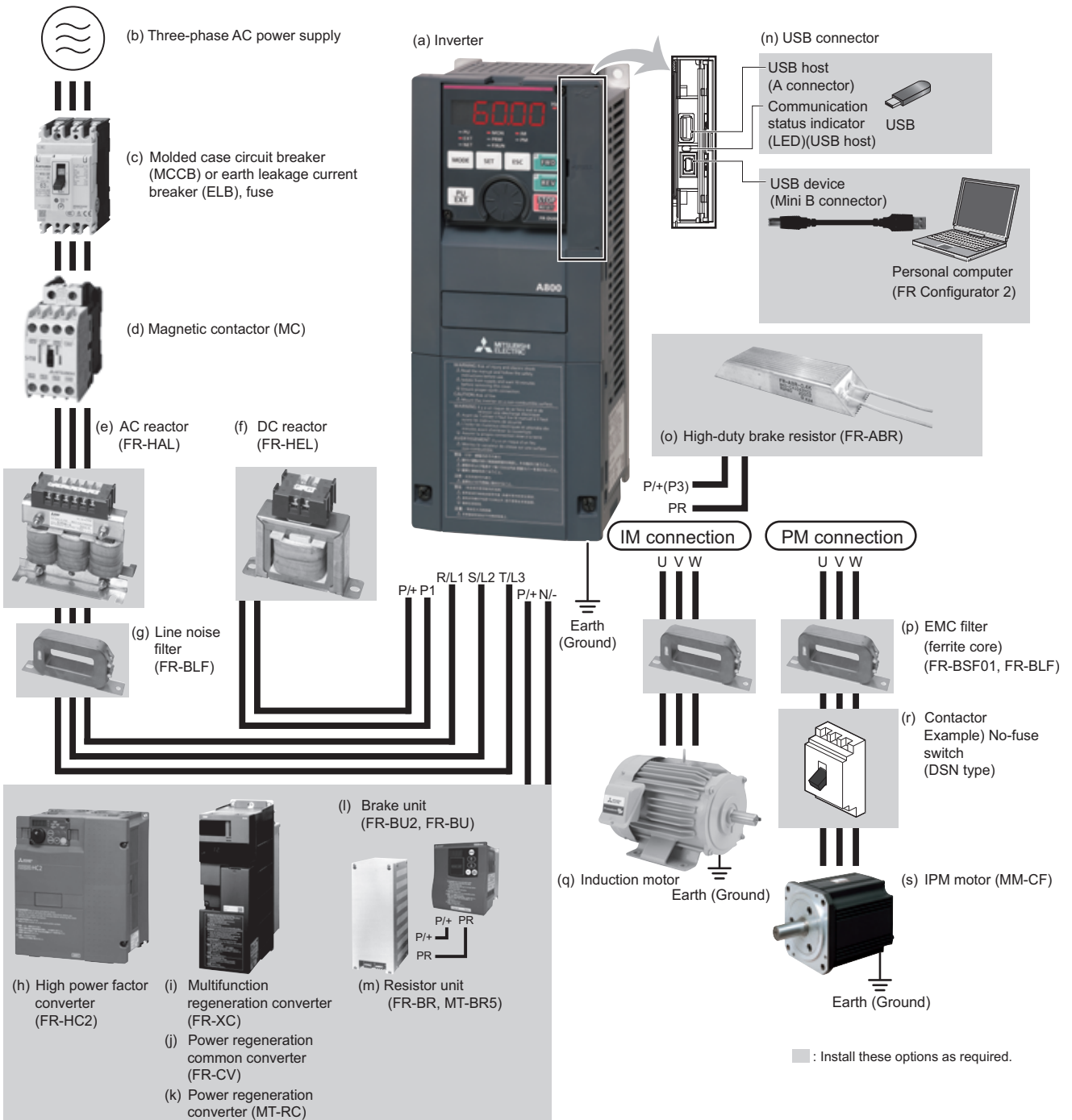



Symbol	Name	Overview	Refer to page
(a)	Inverter (FR-A800)	The life of the inverter is influenced by the surrounding air temperature. The surrounding air temperature should be as low as possible within the permissible range. This must be noted especially when the inverter is installed in an enclosure. Incorrect wiring may lead to damage of the inverter. The control signal lines must be kept fully away from the main circuit lines to protect them from noise. The built-in EMC filter can reduce the noise.	37, 46, 120
(b)	Three-phase AC power supply	Must be within the permissible power supply specifications of the inverter.	826
(c)	Molded case circuit breaker (MCCB), earth leakage circuit breaker (ELB), or fuse	Must be selected carefully since an inrush current flows in the inverter at power ON.	29
(d)	Magnetic contactor (MC)	Install this to ensure safety. Do not use this to start and stop the inverter. Doing so will shorten the life of the inverter.	128
(e)	AC reactor (FR-HAL)	Install this to suppress harmonics and to improve the power factor. An AC reactor (FR-HAL) (option) is required when installing the inverter near a large power supply system (1000 kVA or more). Under such condition, the inverter may be damaged if you do not use a reactor. Select a reactor according to the applied motor capacity.	127
(f)	DC reactor (FR-HEL)	Install this to suppress harmonics and to improve the power factor. Select a reactor according to the applied motor capacity. For the FR-A820-03800(75K) or higher, FR-A840-02160(75K) or higher, or a motor with a capacity of 75 kW or higher, always connect the FR-HEL. When using the DC reactor with the FR-A820-03160(55K) or lower, FR-A840-01800(55K) or lower, remove the jumper across terminals P/+ and P1 before connecting the DC reactor to the inverter.	127
(g)	Noise filter (FR-BLF)	The FR-A820-03160(55K) or lower, FR-A840-01800(55K) or lower are equipped with the common mode choke.	118
(h)	High power factor converter (FR-HC2)	Suppresses the power supply harmonics significantly. Install this as required.	104
(i)	Multifunction regeneration converter (FR-XC) <sup>*1</sup>	Provides a large braking capability. Install this as required.	105
(j)	Power regeneration common converter (FR-CV) <sup>*1</sup>		107
(k)	Power regeneration converter (MT-RC) <sup>*1</sup>		108
(l)	Brake unit (FR-BU2, FR-BU, BU) <sup>*1</sup>	Allows the inverter to provide the optimal regenerative braking capability. Install this as required.	100
(m)	Resistor unit (FR-BR, MT-BR5) <sup>*1</sup>		
(n)	USB connection	Connect between the inverter and a personal computer with a USB (ver. 1.1) cable. Use a USB memory device to copy parameter settings or use the trace function.	85
(o)	High-duty brake resistor (FR-ABR) <sup>*1</sup>	Improves the braking capability of the inverter built-in brake. Remove the jumper across terminals PR and PX to connect this (7.5K or lower). Always install a thermal relay when using a brake resistor for the inverters with 11K or higher capacity.	97
(p)	Noise filter (ferrite core) (FR-BSF01, FR-BLF)	Install this to reduce the electromagnetic noise generated from the inverter. The noise filter is effective in the range from about 0.5 to 5 MHz. A wire should be wound four turns at maximum.	118
(q)	Induction motor	Connect a squirrel-cage induction motor.	—
(r)	Example) No-fuse switch (DSN type)	Connect this for an application where a PM motor is driven by the load even while the inverter power is OFF. Do not open or close the contactor while the inverter is running (outputting).	—
(s)	IPM motor (MM-CF)	Use the specified motor. An IPM motor cannot be driven by the commercial power supply.	833

\*1 To select a stand-alone option, refer to the Instruction Manual of each option.

**NOTE**

- To prevent an electric shock, always earth (ground) the motor and inverter.
- Do not install a power factor correction capacitor, surge suppressor, or capacitor type filter on the inverter's output side. Doing so will cause the inverter shut off or damage the capacitor or surge suppressor. If any of the above devices is connected, immediately remove it. When installing a molded case circuit breaker on the output side of the inverter, contact the manufacturer of the molded case circuit breaker.
- Electromagnetic wave interference:  
The input/output (main circuit) of the inverter includes high frequency components, which may interfere with the communication devices (such as AM radios) used near the inverter. To minimize interference, enabling the built-in EMC filter or installing an external EMC filters is effective. (Refer to [page 120.](#))
- For details on the options and peripheral devices, refer to the respective Instruction Manual.
- A PM motor cannot be driven by the commercial power supply.
- A PM motor is a motor with permanent magnets embedded inside. High voltage is generated at the motor terminals while the motor is running. Before closing the contactor at the output side, make sure that the inverter power is ON and the motor is stopped.

## 2.1.2 Peripheral devices

Check the model of the inverter you purchased. Appropriate peripheral devices must be selected according to the capacity. Refer to the following table for right selection.

## ◆ Molded case circuit breaker / earth leakage circuit breaker

- This is a matrix showing the rated current of the molded case circuit breaker (MCCB) or earth leakage circuit breaker (ELB) (NF or NV type) according to the selected inverter and rating.

Voltage	Inverter model	Without AC/DC power factor improving reactor				With AC/DC power factor improving reactor			
		SLD	LD	ND	HD	SLD	LD	ND	HD
200 V class	FR-A820-00046(0.4K)	10 A	10 A	5 A	5 A	10 A	10 A	5 A	3 A
	FR-A820-00077(0.75K)	15 A	15 A	10 A	5 A	15 A	15 A	10 A	5 A
	FR-A820-00105(1.5K)	20 A	20 A	15 A	10 A	15 A	15 A	15 A	10 A
	FR-A820-00167(2.2K)	30 A	30 A	20 A	15 A	30 A	30 A	15 A	15 A
	FR-A820-00250(3.7K)	50 A	50 A	30 A	20 A	40 A	40 A	30 A	15 A
	FR-A820-00340(5.5K)	75 A	60 A	50 A	30 A	50 A	50 A	40 A	30 A
	FR-A820-00490(7.5K)	100 A	75 A	60 A	50 A	75 A	75 A	50 A	40 A
	FR-A820-00630(11K)	125 A	125 A	75 A	60 A	100 A	100 A	75 A	50 A
	FR-A820-00770(15K)	150 A	150 A	125 A	75 A	125 A	125 A	100 A	75 A
	FR-A820-00930(18.5K)	175 A	175 A	150 A	125 A	150 A	125 A	125 A	100 A
	FR-A820-01250(22K)	225 A	225 A	175 A	150 A	175 A	150 A	125 A	125 A
	FR-A820-01540(30K)	300 A	250 A	225 A	175 A	225 A	200 A	150 A	125 A
	FR-A820-01870(37K)	350 A	300 A	250 A	225 A	250 A	225 A	200 A	150 A
	FR-A820-02330(45K)	400 A	400 A	300 A	250 A	350 A	300 A	225 A	200 A
	FR-A820-03160(55K)	—	—	400 A	300 A	500 A	400 A	300 A	225 A
	FR-A820-03800(75K)	—	—	—	—	500 A	400 A	400 A	300 A
FR-A820-04750(90K)	—	—	—	—	600 A	500 A	400 A	400 A	
400 V class	FR-A840-00023(0.4K)	5 A	5 A	5 A	5 A	5 A	5 A	5 A	3 A
	FR-A840-00038(0.75K)	10 A	10 A	5 A	5 A	10 A	10 A	5 A	5 A
	FR-A840-00052(1.5K)	10 A	10 A	10 A	5 A	10 A	10 A	10 A	5 A
	FR-A840-00083(2.2K)	20 A	20 A	10 A	10 A	15 A	15 A	10 A	10 A
	FR-A840-00126(3.7K)	30 A	30 A	20 A	10 A	20 A	20 A	15 A	10 A
	FR-A840-00170(5.5K)	30 A	30 A	30 A	20 A	30 A	30 A	20 A	15 A
	FR-A840-00250(7.5K)	50 A	50 A	30 A	30 A	40 A	40 A	30 A	20 A
	FR-A840-00310(11K)	60 A	60 A	50 A	30 A	50 A	50 A	40 A	30 A
	FR-A840-00380(15K)	75 A	75 A	60 A	50 A	60 A	60 A	50 A	40 A
	FR-A840-00470(18.5K)	100 A	100 A	75 A	60 A	75 A	75 A	60 A	50 A
	FR-A840-00620(22K)	125 A	125 A	100 A	75 A	100 A	100 A	75 A	60 A
	FR-A840-00770(30K)	150 A	150 A	125 A	100 A	125 A	100 A	100 A	75 A
	FR-A840-00930(37K)	175 A	175 A	150 A	125 A	150 A	125 A	100 A	100 A
	FR-A840-01160(45K)	200 A	200 A	175 A	150 A	175 A	150 A	125 A	100 A
	FR-A840-01800(55K)	—	—	200 A	175 A	225 A	200 A	150 A	125 A
	FR-A840-02160(75K)	—	—	—	—	225 A	225 A	200 A	150 A
	FR-A840-02600(90K)	—	—	—	—	350 A	225 A	225 A	200 A
	FR-A840-03250(110K)	—	—	—	—	400 A	350 A	225 A	225 A
	FR-A840-03610(132K)	—	—	—	—	400 A	400 A	350 A	225 A
	FR-A840-04320(160K)	—	—	—	—	500 A	400 A	400 A	350 A
FR-A840-04810(185K)	—	—	—	—	600 A	500 A	400 A	400 A	
FR-A840-05470(220K)	—	—	—	—	600 A	600 A	500 A	400 A	
FR-A840-06100(250K)	—	—	—	—	700 A	600 A	600 A	500 A	
FR-A840-06830(280K)	—	—	—	—	800 A	700 A	600 A	600 A	

### NOTE

- Select an MCCB according to the power supply capacity.
- Install one MCCB per inverter. For the use in the United States or Canada, refer to "Instructions for UL and cUL" in the Instruction Manual (Startup) or Instruction Manual (Hardware), and select an appropriate fuse or molded case circuit breaker (MCCB).

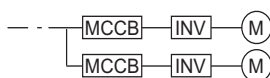

- When the inverter capacity is larger than the motor capacity, select an MCCB and a magnetic contactor according to the inverter model, and select cables and reactors according to the motor output.
- When the breaker installed on the inverter input side is shut off, check for the wiring fault (short circuit), damage to internal parts of the inverter etc. The cause of the output shutoff must be identified and removed before turning ON the power of the breaker.

## ◆ Magnetic contactor at the inverter's input line

- This is a matrix showing the model name of the Mitsubishi magnetic contactor to be installed at the inverter's input line according to the selected inverter and rating.

Voltage	Inverter model	Without AC/DC power factor improving reactor				With AC/DC power factor improving reactor			
		SLD	LD	ND	HD	SLD	LD	ND	HD
200 V class	FR-A820-00046(0.4K)	S-T10	S-T10	S-T10	S-T10	S-T10	S-T10	S-T10	S-T10
	FR-A820-00077(0.75K)	S-T10	S-T10	S-T10	S-T10	S-T10	S-T10	S-T10	S-T10
	FR-A820-00105(1.5K)	S-T10	S-T10	S-T10	S-T10	S-T10	S-T10	S-T10	S-T10
	FR-A820-00167(2.2K)	S-T21	S-T21	S-T10	S-T10	S-T10	S-T10	S-T10	S-T10
	FR-A820-00250(3.7K)	S-T25	S-T25	S-T21	S-T10	S-T21	S-T21	S-T10	S-T10
	FR-A820-00340(5.5K)	S-T35	S-T35	S-T35	S-T21	S-T35	S-T25	S-T21	S-T10
	FR-A820-00490(7.5K)	S-T50	S-T35	S-T35	S-T35	S-T35	S-T35	S-T35	S-T21
	FR-A820-00630(11K)	S-T65	S-T50	S-T35	S-T35	S-T50	S-T50	S-T35	S-T35
	FR-A820-00770(15K)	S-T65	S-T65	S-T50	S-T35	S-T50	S-T50	S-T50	S-T35
	FR-A820-00930(18.5K)	S-T100	S-T100	S-T65	S-T50	S-T65	S-T65	S-T50	S-T50
	FR-A820-01250(22K)	S-N150	S-T100	S-T100	S-T65	S-T100	S-T100	S-T65	S-T50
	FR-A820-01540(30K)	S-N150	S-N150	S-T100	S-T100	S-N150	S-N125	S-T100	S-T65
	FR-A820-01870(37K)	S-N180	S-N180	S-N150	S-T100	S-N150	S-N150	S-N125	S-T100
	FR-A820-02330(45K)	S-N220	S-N220	S-N180	S-N150	S-N180	S-N180	S-N150	S-N125
	FR-A820-03160(55K)	—	—	S-N220	S-N180	S-N300	S-N300	S-N180	S-N150
	FR-A820-03800(75K)	—	—	—	—	S-N400	S-N300	S-N300	S-N180
FR-A820-04750(90K)	—	—	—	—	S-N600	S-N400	S-N300	S-N300	
400 V class	FR-A840-00023(0.4K)	S-T10	S-T10	S-T10	S-T10	S-T10	S-T10	S-T10	S-T10
	FR-A840-00038(0.75K)	S-T10	S-T10	S-T10	S-T10	S-T10	S-T10	S-T10	S-T10
	FR-A840-00052(1.5K)	S-T10	S-T10	S-T10	S-T10	S-T10	S-T10	S-T10	S-T10
	FR-A840-00083(2.2K)	S-T10	S-T10	S-T10	S-T10	S-T10	S-T10	S-T10	S-T10
	FR-A840-00126(3.7K)	S-T21	S-T21	S-T10	S-T10	S-T12	S-T12	S-T10	S-T10
	FR-A840-00170(5.5K)	S-T21	S-T21	S-T21	S-T10	S-T21	S-T21	S-T12	S-T10
	FR-A840-00250(7.5K)	S-T21	S-T21	S-T21	S-T21	S-T21	S-T21	S-T21	S-T12
	FR-A840-00310(11K)	S-T35	S-T35	S-T21	S-T21	S-T21	S-T21	S-T21	S-T21
	FR-A840-00380(15K)	S-T35	S-T35	S-T35	S-T21	S-T35	S-T35	S-T21	S-T21
	FR-A840-00470(18.5K)	S-T35	S-T35	S-T35	S-T35	S-T35	S-T35	S-T35	S-T21
	FR-A840-00620(22K)	S-T50	S-T50	S-T35	S-T35	S-T50	S-T50	S-T35	S-T35
	FR-A840-00770(30K)	S-T65	S-T65	S-T50	S-T35	S-T50	S-T50	S-T50	S-T35
	FR-A840-00930(37K)	S-T100	S-T100	S-T65	S-T50	S-T65	S-T65	S-T50	S-T50
	FR-A840-01160(45K)	S-N150	S-T100	S-T100	S-T65	S-T100	S-T100	S-T65	S-T50
	FR-A840-01800(55K)	—	—	S-T100	S-T100	S-N150	S-T100	S-T100	S-T65
	FR-A840-02160(75K)	—	—	—	—	S-N180	S-N150	S-T100	S-T100
	FR-A840-02600(90K)	—	—	—	—	S-N220	S-N180	S-N150	S-T100
	FR-A840-03250(110K)	—	—	—	—	S-N300	S-N220	S-N180	S-N150
	FR-A840-03610(132K)	—	—	—	—	S-N300	S-N300	S-N220	S-N180
	FR-A840-04320(160K)	—	—	—	—	S-N400	S-N300	S-N300	S-N220
FR-A840-04810(185K)	—	—	—	—	S-N600	S-N400	S-N300	S-N300	
FR-A840-05470(220K)	—	—	—	—	S-N600	S-N600	S-N400	S-N300	
FR-A840-06100(250K)	—	—	—	—	S-N600	S-N600	S-N600	S-N400	
FR-A840-06830(280K)	—	—	—	—	S-N800	S-N600	S-N600	S-N600	

**NOTE**

- The matrix shows the magnetic contactor selected according to the standards of Japan Electrical Manufacturers' Association (JEM standards) for AC-1 class. The electrical durability of magnetic contactor is 500,000 times. When the MC is used for emergency stops during motor driving, the electrical durability is 25 times. If using the MC for emergency stop during motor driving, select the MC for the inverter input current according to the rated current against JEM 1038 standards for AC-3 class. When installing an MC on the inverter output side to switch to the commercial-power supply operation while running a general-purpose motor, select the MC for the rated motor current according to the rated current against JEM 1038 standards for AC-3 class.
- When the inverter capacity is larger than the motor capacity, select an MCCB and a magnetic contactor according to the inverter model, and select cables and reactors according to the motor output.
- When the breaker installed on the inverter input side is shut off, check for the wiring fault (short circuit), damage to internal parts of the inverter etc. The cause of the output shutoff must be identified and removed before turning ON the power of the breaker.

## 2.2 Removal and reinstallation of the operation panel or the front covers

### ◆ Removal and reinstallation of the operation panel

- Loosen the two screws on the operation panel. (These screws cannot be removed.)
- Press the upper edge of the operation panel while pulling out the operation panel.

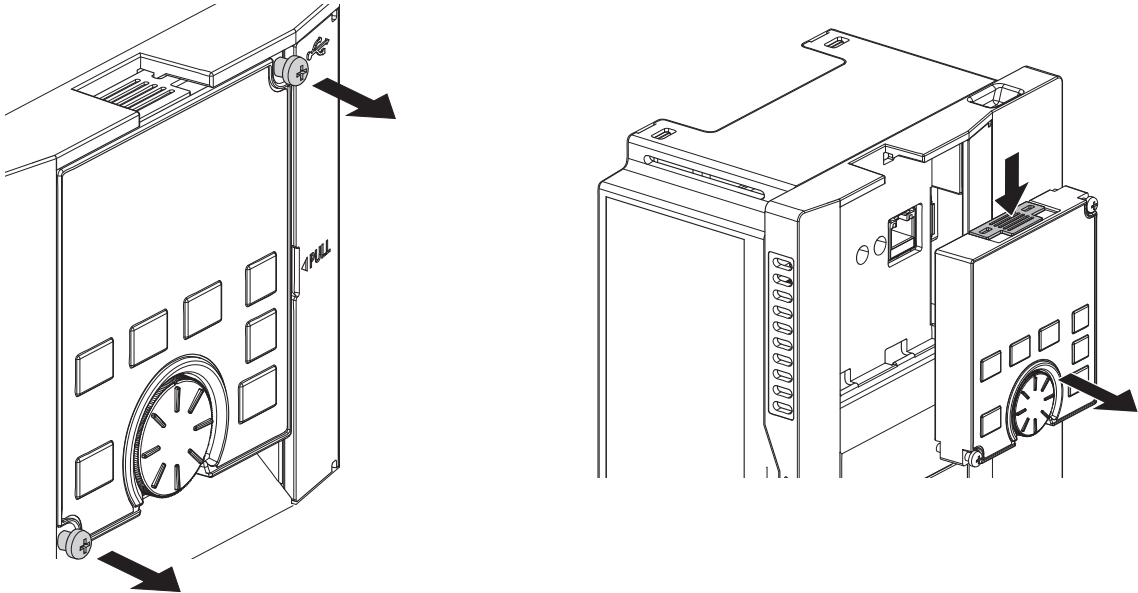

To reinstall the operation panel, align its connector on the back with the PU connector of the inverter, and insert the operation panel. After confirming that the operation panel is fit securely, tighten the screws. (Tightening torque: 0.40 to 0.45 N·m)

### ◆ Removal of the lower front cover (FR-A820-01540(30K) or lower, FR-A840-00770(30K) or lower)

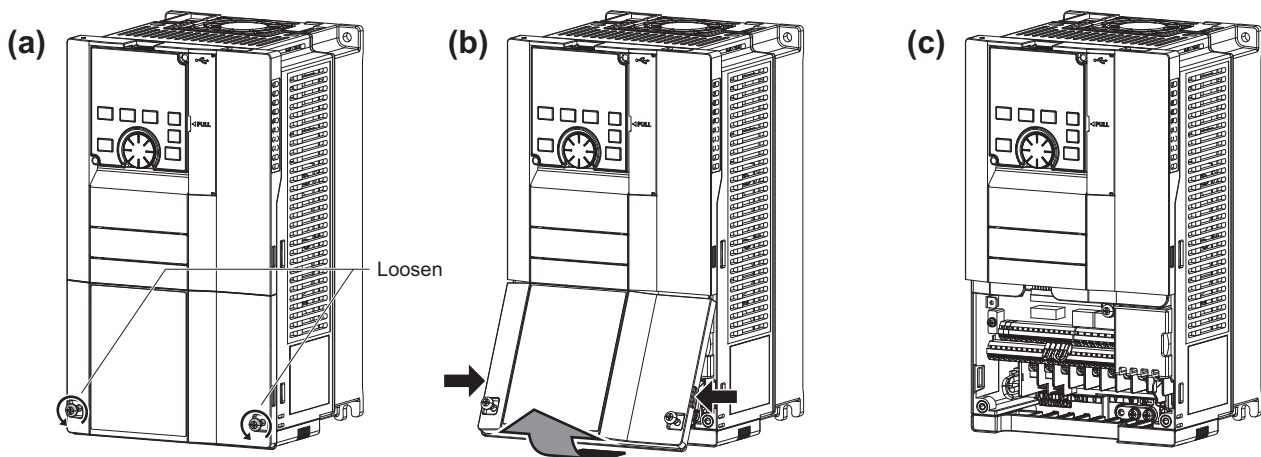

- Loosen the screws on the lower front cover. (These screws cannot be removed.)
- While holding the areas around the installation hooks on the sides of the lower front cover, pull out the cover using its upper side as a support.
- With the lower front cover removed, the main circuit and the control circuit can be wired.

## ◆ Removal of the upper front cover (FR-A820-01540(30K) or lower, FR-A840-00770(30K) or lower)

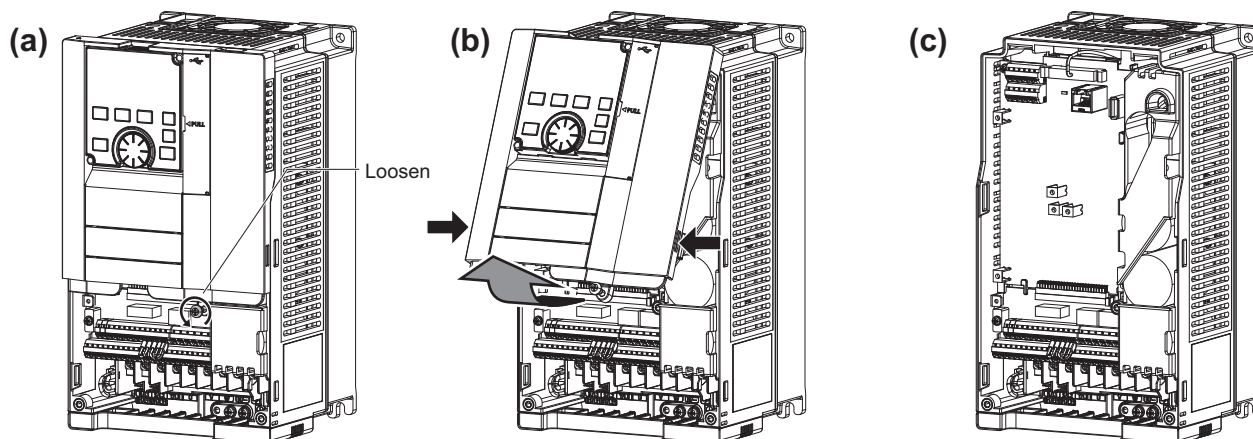

- (a) With the lower front cover removed, loosen the screw on the upper front cover. (This screw cannot be removed.) (FR-A820-00340(5.5K) to FR-A820-01540(30K) and FR-A840-00170(5.5K) to FR-A840-00770(30K) have two mounting screws.)
- (b) While holding the areas around the installation hooks on the sides of the upper front cover, pull out the cover using its upper side as a support.
- (c) With the upper front cover removed, the RS-485 terminals can be wired and the plug-in option can be installed.

## ◆ Reinstallation of the front covers (FR-A820-01540(30K) or lower, FR-A840-00770(30K) or lower)

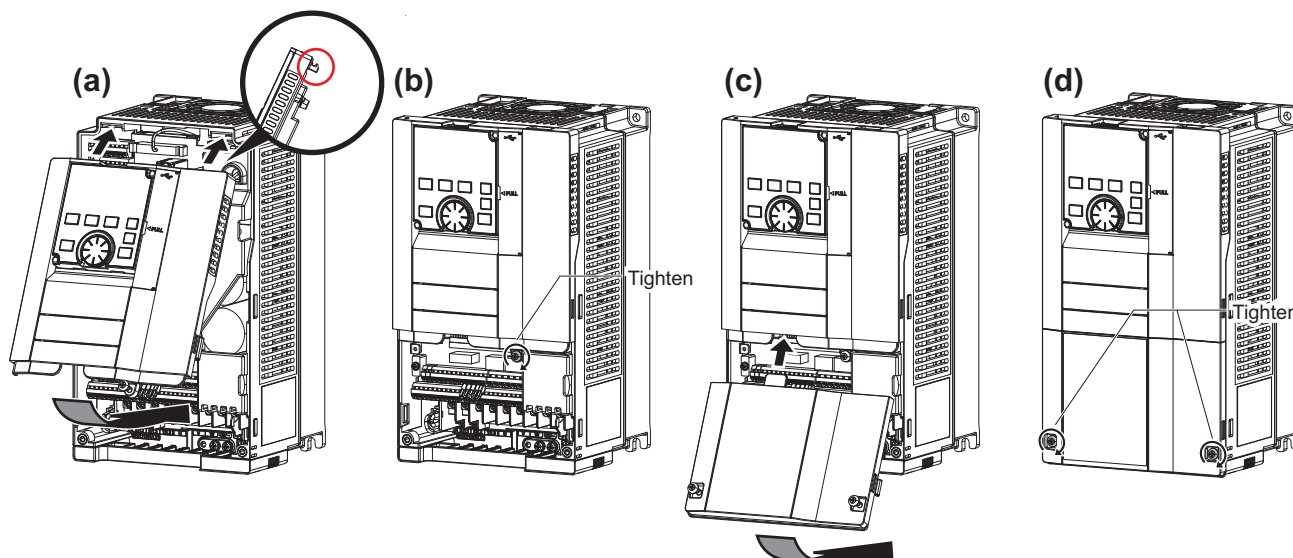

- (a) Clip on the upper front cover as illustrated. Check that it is properly secured.
- (b) Tighten the screws on the lower part of the cover. (FR-A820-00340(5.5K) to FR-A820-01540(30K) and FR-A840-00170(5.5K) to FR-A840-00770(30K) have two mounting screws.)
- (c) Install the lower front cover by inserting the upper hook into the socket of the upper front cover.
- (d) Tighten the screws on the lower part of the lower front cover.

### NOTE

- When installing the upper front cover, fit the connector of the operation panel securely along the guides of the PU connector.



◆ Removal of the lower front cover (FR-A820-01870(37K) or higher, FR-A840-00930(37K) or higher)

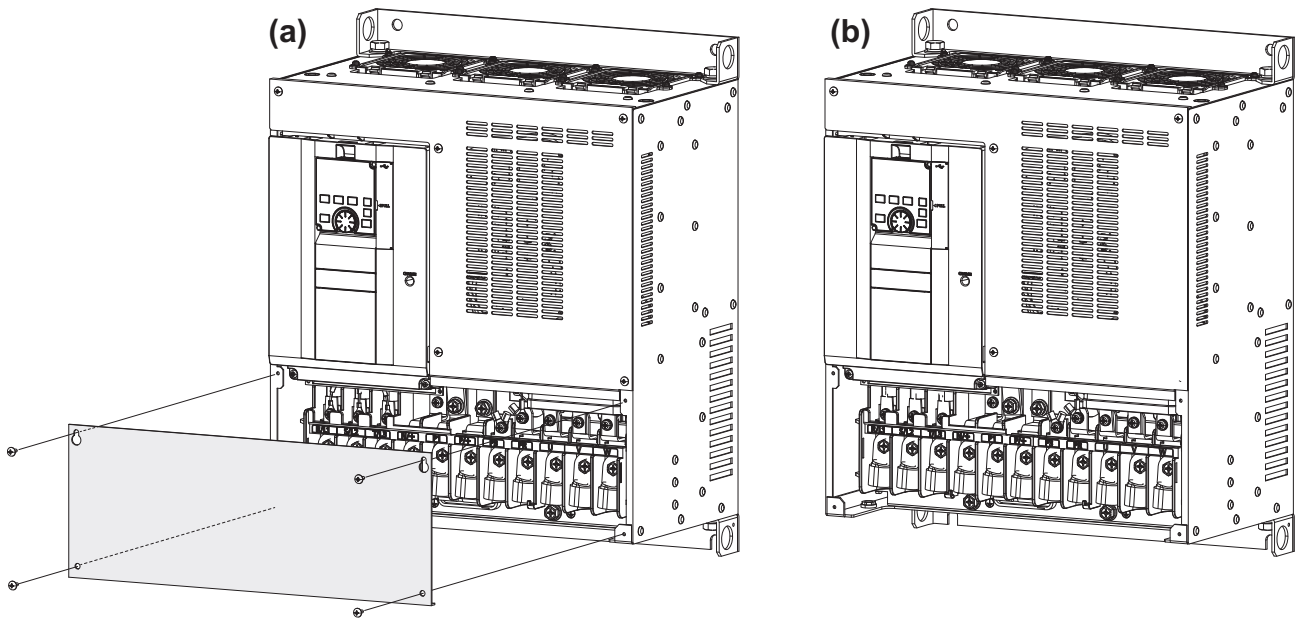

- (a) Remove the mounting screws to remove the lower front cover.  
 (b) With the lower front cover removed, the main circuit can be wired.

◆ Removal of the upper front cover (FR-A820-01870(37K) or higher, FR-A840-00930(37K) or higher)

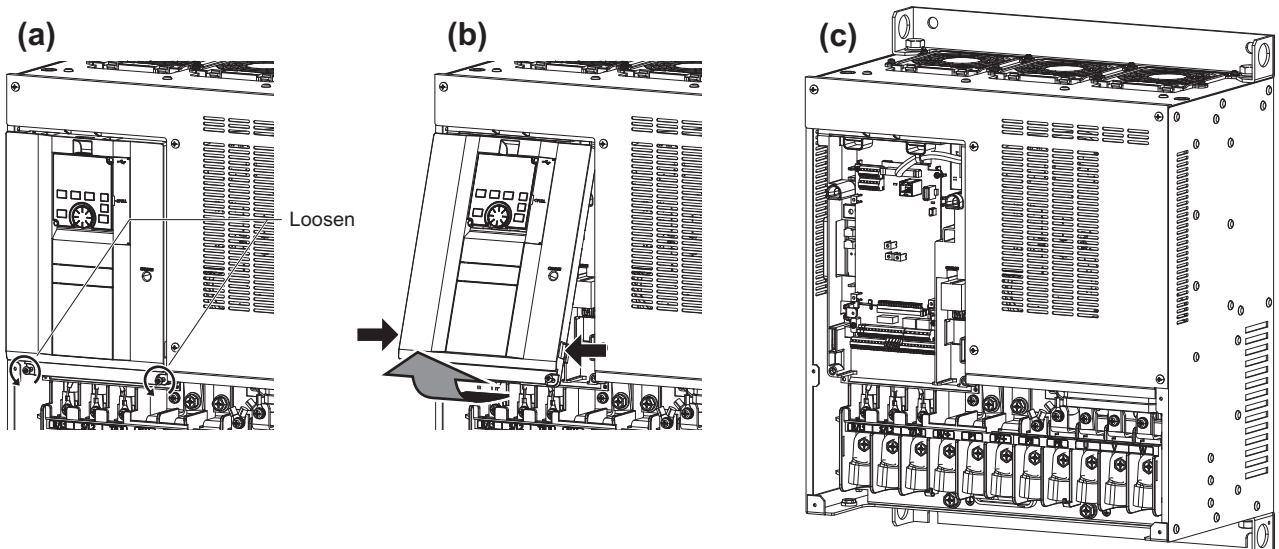

- (a) With the lower front cover removed, loosen the screws on the upper front cover. (These screws cannot be removed.)  
 (b) While holding the areas around the installation hooks on the sides of the upper front cover, pull out the cover using its upper side as a support.  
 (c) With the upper front cover removed, the control circuit and the RS-485 terminals can be wired and the plug-in option can be installed.



◆ Reinstallation of the front covers (FR-A820-01870(37K) or higher, FR-A840-00930(37K) or higher)

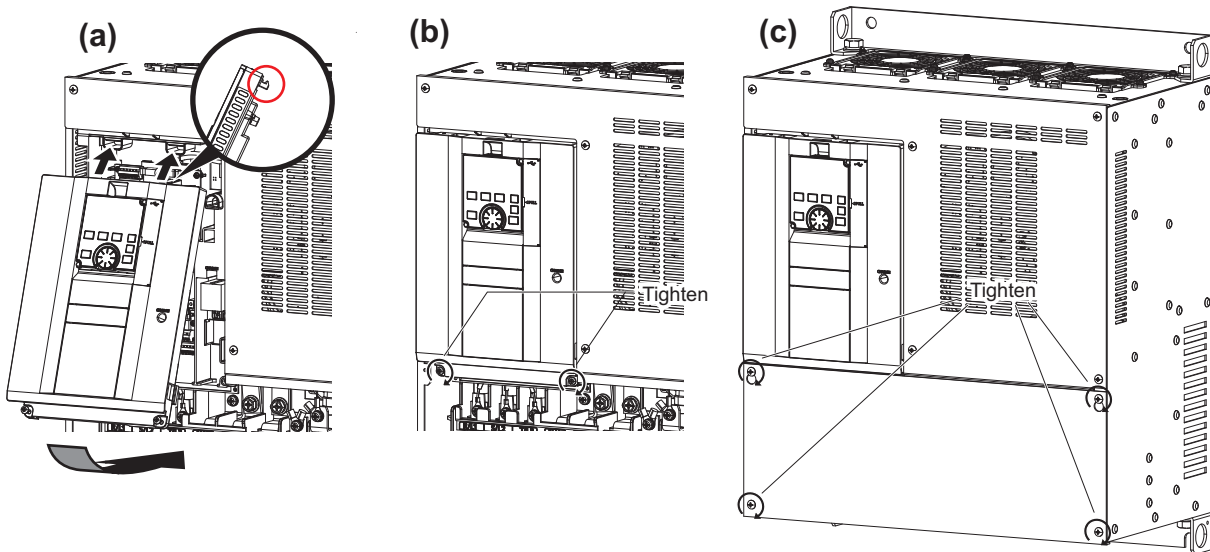

- (a) Clip on the upper front cover as illustrated.  
Check that it is properly secured.
- (b) Tighten the screws on the lower part of the cover.
- (c) Attach the lower front cover using the screws.

**NOTE**

- Fully make sure that the front cover has been reinstalled securely. Always tighten the installation screws of the front cover.

## 2.3 Installation of the inverter and enclosure design

When designing or manufacturing an inverter enclosure, determine the structure, size, and device layout of the enclosure by fully considering the conditions such as heat generation of the contained devices and the operating environment. An inverter unit uses many semiconductor devices. To ensure higher reliability and long period of operation, operate the inverter in the ambient environment that completely satisfies the equipment specifications.

### 2.3.1 Inverter installation environment

The following table lists the standard specifications of the inverter installation environment. Using the inverter in an environment that does not satisfy the conditions deteriorates the performance, shortens the life, and causes a failure. Refer to the following points, and take adequate measures.

#### ◆ Standard environmental specifications of the inverter

Item		Description	
Surrounding air temperature	LD, ND (initial setting), HD	-10 to +50°C <sup>*1</sup> (non-freezing)	
	SLD	-10 to +40°C <sup>*2</sup> (non-freezing)	
Ambient humidity		With circuit board coating (conforming to class 3C2/3S2 in IEC 60721-3-3): 95% RH or less (non-condensing) Without circuit board coating: 90% RH or less (non-condensing)	
Storage temperature		-20 to +65°C <sup>*3</sup>	
Atmosphere		Indoors (free from corrosive gas, flammable gas, oil mist, dust and dirt)	
Altitude		Maximum 2500 m <sup>*4</sup>	
Vibration		5.9 m/s <sup>2</sup> or less <sup>*5</sup> at 10 to 55 Hz (in either X, Y, or Z direction)	

\*1 0 to +50°C for the FR-A800-GF.

\*2 0 to +40°C for the FR-A800-GF.

\*3 Temperature applicable for a short time, for example, in transit.

\*4 For the installation at an altitude above 1000 m, consider a 3% reduction in the rated current per 500 m increase in altitude.

\*5 2.9 m/s<sup>2</sup> or less for the FR-A840-04320(160K) or higher.

#### ◆ Temperature

The permissible surrounding air temperature of the inverter is between -10°C and +50°C (-10°C and +40°C at the SLD rating). (The permissible surrounding air temperature of the FR-A800-GF is between 0 and +50°C (0 and +40°C for the SLD rating).) Always operate the inverter within this temperature range. Operation outside this range will considerably shorten the service lives of the semiconductors, parts, capacitors and others. Take the following measures to keep the surrounding air temperature of the inverter within the specified range.

##### ■ Measures against high temperature

- Use a forced ventilation system or similar cooling system. (Refer to [page 41](#).)
- Install the enclosure in an air-conditioned electric chamber.
- Block direct sunlight.
- Provide a shield or similar plate to avoid direct exposure to the radiated heat and wind of a heat source.
- Ventilate the area around the enclosure well.

##### ■ Measures against low temperature

- Provide a space heater in the enclosure.
- Do not power OFF the inverter. (Keep the start signal of the inverter OFF.)

##### ■ Sudden temperature changes

- Select an installation place where temperature does not change suddenly.
- Avoid installing the inverter near the air outlet of an air conditioner.
- If temperature changes are caused by opening/closing of a door, install the inverter away from the door.

- For the amount of heat generated by the inverter unit, refer to [page 40](#).

## ◆ Humidity

Operate the inverter within the ambient air humidity of usually 45 to 90% (up to 95% with circuit board coating). Too high humidity will pose problems of reduced insulation and metal corrosion. On the other hand, too low humidity may cause a spatial electrical breakdown. The humidity conditions for the insulation distance defined in JEM 1103 standard "Insulation Distance from Control Equipment" is 45 to 85%.

### ■ Measures against high humidity

- Make the enclosure enclosed, and provide it with a hygroscopic agent.
- Provide dry air into the enclosure from outside.
- Provide a space heater in the enclosure.

### ■ Measures against low humidity

Air with proper humidity can be blown into the enclosure from outside. Also, when installing or inspecting the unit, discharge your body (static electricity) beforehand, and keep your body away from the parts and patterns.

### ■ Measures against condensation

Condensation may occur if frequent operation stops change the in-enclosure temperature suddenly or if the outside air temperature changes suddenly.

Condensation causes such faults as reduced insulation and corrosion.

- Take the measures against high humidity.
- Do not power OFF the inverter. (Keep the start signal of the inverter OFF.)

## ◆ Dust, dirt, oil mist

Dust and dirt will cause such faults as poor contacts, reduced insulation and cooling effect due to the moisture-absorbed accumulated dust and dirt, and in-enclosure temperature rise due to a clogged filter. In an atmosphere where conductive powder floats, dust and dirt will cause such faults as malfunction, deteriorated insulation and short circuit in a short time. Since oil mist will cause similar conditions, it is necessary to take adequate measures.

### ■ Countermeasure

- Place the inverter in a totally enclosed enclosure.  
Take measures if the in-enclosure temperature rises. (Refer to [page 41](#).)
- Purge air.  
Pump clean air from outside to make the in-enclosure air pressure higher than the outside air pressure.

## ◆ Corrosive gas, salt damage

If the inverter is exposed to corrosive gas or to salt near a beach, the printed board patterns and parts will corrode or the relays and switches will result in poor contact.

In such places, take the measures given in the previous paragraph.

## ◆ Explosive, flammable gases

As the inverter is non-explosion proof, it must be contained in an explosion-proof enclosure. In places where explosion may be caused by explosive gas, dust or dirt, an enclosure cannot be used unless it structurally complies with the guidelines and has passed the specified tests. This makes the enclosure itself expensive (including the test charges). The best way is to avoid installation in such places and install the inverter in a non-hazardous place.

## ◆ High altitude

Use the inverter at an altitude of within 2500 m. For use at an altitude above 1000 m, consider a 3% reduction in the rated current per 500 m increase in altitude.

If it is used at a higher place, it is likely that thin air will reduce the cooling effect and low air pressure will deteriorate dielectric strength.

## ◆ Vibration, impact

The vibration resistance of the inverter is up to  $5.9 \text{ m/s}^2$  ( $2.9 \text{ m/s}^2$  or less for the FR-A840-04320(160K) or higher) at 10 to 55 Hz frequency and 1 mm amplitude for the directions of X, Y, Z axes. Applying vibration and impacts for a long time may loosen the structures and cause poor contacts of connectors, even if those vibration and impacts are within the specified values. Especially when impacts are applied repeatedly, caution must be taken because such impacts may break the installation feet.

### ■ Countermeasure

- Provide the enclosure with rubber vibration isolators.
- Strengthen the structure to prevent the enclosure from resonance.
- Install the enclosure away from the sources of the vibration.

## 2.3.2 Amount of heat generated by the inverter

### ◆ Installing the heat sink inside the enclosure

When the heat sink is installed inside the enclosure, the amount of heat generated by the inverter unit is shown in the following tables.

Voltage	Inverter model	Amount of heat generated (W)			
		SLD	LD	ND	HD
200 V class	FR-A820-00046(0.4K)	60	55	40	30
	FR-A820-00077(0.75K)	95	85	60	40
	FR-A820-00105(1.5K)	140	130	110	70
	FR-A820-00167(2.2K)	200	185	130	100
	FR-A820-00250(3.7K)	310	285	190	135
	FR-A820-00340(5.5K)	355	320	240	160
	FR-A820-00490(7.5K)	525	480	350	230
	FR-A820-00630(11K)	570	515	370	280
	FR-A820-00770(15K)	770	700	590	450
	FR-A820-00930(18.5K)	950	850	720	600
	FR-A820-01250(22K)	1000	950	880	840
	FR-A820-01540(30K)	1450	1300	1050	880
	FR-A820-01870(37K)	1650	1480	1270	1050
	FR-A820-02330(45K)	2120	1900	1610	1300
	FR-A820-03160(55K)	2750	2450	1830	1450
	FR-A820-03800(75K)	3020	2710	2180	1700
FR-A820-04750(90K)	3960	3530	2700	2220	
400 V class	FR-A840-00023(0.4K)	55	50	40	30
	FR-A840-00038(0.75K)	75	70	55	40
	FR-A840-00052(1.5K)	85	80	70	50
	FR-A840-00083(2.2K)	130	120	100	75
	FR-A840-00126(3.7K)	175	160	130	90
	FR-A840-00170(5.5K)	245	230	170	135
	FR-A840-00250(7.5K)	345	315	220	165
	FR-A840-00310(11K)	370	345	280	210
	FR-A840-00380(15K)	450	415	390	285
	FR-A840-00470(18.5K)	565	520	450	385
	FR-A840-00620(22K)	740	675	520	450
	FR-A840-00770(30K)	930	825	690	560
	FR-A840-00930(37K)	1110	1020	840	700
	FR-A840-01160(45K)	1340	1220	1020	860
	FR-A840-01800(55K)	2000	1640	1290	1060
	FR-A840-02160(75K)	2520	2100	1790	1350
	FR-A840-02600(90K)	3150	2575	2200	1770
	FR-A840-03250(110K)	3600	2800	2300	1850
	FR-A840-03610(132K)	4050	3600	2800	2250
	FR-A840-04320(160K)	4650	3800	3450	2650
FR-A840-04810(185K)	5300	4650	3850	3400	
FR-A840-05470(220K)	5850	5100	4550	3700	
FR-A840-06100(250K)	6650	5850	5100	4500	
FR-A840-06830(280K)	7550	6600	5900	5050	

#### NOTE

- The figures indicate the amount of heat generated when the output current is the rated current, power supply voltage is 220 V (200 V class) or 440 V (400 V class), and the carrier frequency is 2 kHz.

## ◆ Installing the heat sink outside the enclosure

When the heat sink is installed outside the enclosure, the amount of heat generated by the inverter unit is shown in the following tables. (For details on protruding the heat sink through a panel, refer to [page 44.](#))

Voltage	Inverter model	Amount of heat generated (W)							
		Heat sink section (outside of enclosure)				Control section (inside of enclosure)			
		SLD	LD	ND	HD	SLD	LD	ND	HD
200 V class	FR-A820-00105(1.5K)	104	95	77	40	36	35	33	30
	FR-A820-00167(2.2K)	161	147	95	70	39	38	35	30
	FR-A820-00250(3.7K)	263	240	155	103	47	45	35	32
	FR-A820-00340(5.5K)	265	235	174	110	90	85	66	50
	FR-A820-00490(7.5K)	375	340	244	155	150	140	106	75
	FR-A820-00630(11K)	405	365	261	190	165	150	109	90
	FR-A820-00770(15K)	555	500	421	315	215	200	169	135
	FR-A820-00930(18.5K)	690	615	520	430	260	235	200	170
	FR-A820-01250(22K)	700	665	620	595	300	285	260	245
	FR-A820-01540(30K)	1035	925	745	615	415	375	305	265
	FR-A820-01870(37K)	1170	1040	895	735	480	440	375	315
	FR-A820-02330(45K)	1520	1360	1150	920	600	540	460	380
	FR-A820-03160(55K)	1960	1740	1280	1000	790	710	550	450
	FR-A820-03800(75K)	2165	1930	1530	1180	855	780	650	520
FR-A820-04750(90K)	2860	2530	1925	1560	1100	1000	775	660	
400 V class	FR-A840-00023(0.4K)	20	18	12	6	35	32	28	24
	FR-A840-00038(0.75K)	36	32	23	12	39	38	32	28
	FR-A840-00052(1.5K)	42	39	33	19	43	41	37	31
	FR-A840-00083(2.2K)	77	71	57	38	53	49	43	37
	FR-A840-00126(3.7K)	120	109	86	53	55	51	44	37
	FR-A840-00170(5.5K)	180	170	120	90	65	60	50	45
	FR-A840-00250(7.5K)	260	235	160	115	85	80	60	50
	FR-A840-00310(11K)	260	245	195	145	110	100	85	65
	FR-A840-00380(15K)	315	290	275	200	135	125	115	85
	FR-A840-00470(18.5K)	395	360	310	265	170	160	140	120
	FR-A840-00620(22K)	510	465	360	305	230	210	160	145
	FR-A840-00770(30K)	655	575	480	385	275	250	210	175
	FR-A840-00930(37K)	780	720	590	485	330	300	250	215
	FR-A840-01160(45K)	970	880	740	610	370	340	280	250
	FR-A840-01800(55K)	1400	1140	890	730	600	500	400	330
	FR-A840-02160(75K)	1780	1470	1250	925	740	630	540	425
	FR-A840-02600(90K)	2235	1820	1540	1230	915	755	660	540
	FR-A840-03250(110K)	2540	1960	1590	1260	1060	840	710	590
	FR-A840-03610(132K)	2830	2500	1950	1570	1220	1100	850	680
	FR-A840-04320(160K)	3250	2660	2410	1850	1400	1140	1040	800
FR-A840-04810(185K)	3700	3250	2690	2380	1600	1400	1160	1020	
FR-A840-05470(220K)	4090	3570	3180	2590	1760	1530	1370	1110	
FR-A840-06100(250K)	4650	4090	3570	3150	2000	1760	1530	1350	
FR-A840-06830(280K)	5280	4620	4130	3530	2270	1980	1770	1520	

### NOTE

- The figures indicate the amount of heat generated when the output current is the rated current, power supply voltage is 220 V (200 V class) or 440 V (400 V class), and the carrier frequency is 2 kHz.

## 2.3.3 Cooling system types for inverter enclosure

From the enclosure that contains the inverter, the heat of the inverter and other equipment (transformers, lamps, resistors, etc.) and the incoming heat such as direct sunlight must be dissipated to keep the in-enclosure temperature lower than the permissible temperatures of the in-enclosure equipment including the inverter.

The cooling systems are classified as follows in terms of the cooling calculation method.

- Cooling by natural heat dissipation from the enclosure surface (totally enclosed type)
- Cooling by heat sink (aluminum fin, etc.)

- Cooling by ventilation (forced ventilation type, pipe ventilation type)
- Cooling by heat exchanger or cooler (heat pipe, cooler, etc.)

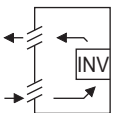
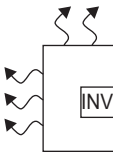
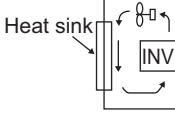
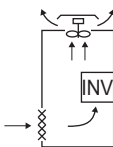
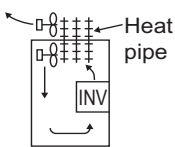
Cooling system		Enclosure structure	Comment
Natural	Natural ventilation (enclosed type / open type)		This system is low in cost and generally used, but the enclosure size increases as the inverter capacity increases. This system is for relatively small capacities.
	Natural ventilation (totally enclosed type)		Being a totally enclosed type, this system is the most appropriate for hostile environment having dust, dirt, oil mist, etc. The enclosure size increases depending on the inverter capacity.
Forced air	Heat sink cooling		This system has restrictions on the heat sink mounting position and area. This system is for relatively small capacities.
	Forced ventilation		This system is for general indoor installation. This is appropriate for enclosure downsizing and cost reduction, and often used.
	Heat pipe		This system is a totally enclosed type, and is appropriate for enclosure downsizing.

## 2.3.4 Inverter installation

### ◆ Inverter placement

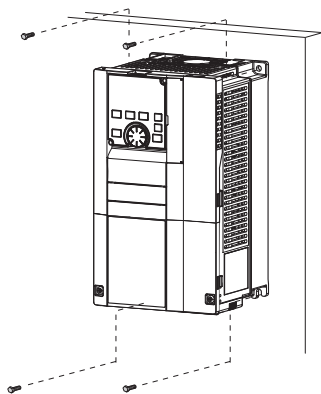

Fix six positions for the FR-A840-04320(160K) or higher.

- Install the inverter on a strong surface securely with screws.
- Leave enough clearances and take cooling measures.
- Avoid places where the inverter is subjected to direct sunlight, high temperature and high humidity.
- Install the inverter on a nonflammable wall surface.
- When encasing multiple inverters in an enclosure, install them in parallel as a cooling measure.
- For heat dissipation and maintenance, keep clearance between the inverter and the other devices or enclosure surface. The space below the inverter is required for wiring, and the space above the inverter is required for heat dissipation.
- When designing or building an enclosure for the inverter, carefully consider influencing factors such as heat generation of the contained devices and the operating environment.

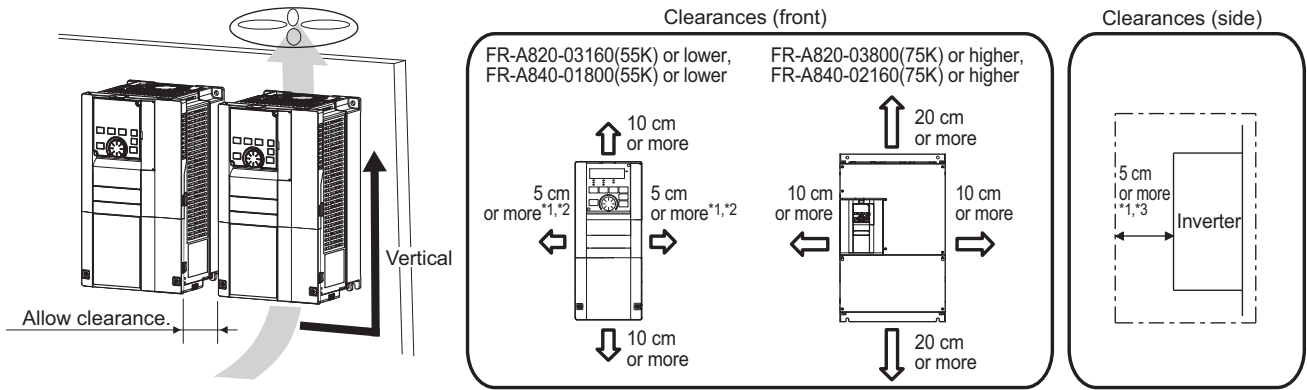

\*1 For the FR-A820-00250(3.7K) or lower and FR-A840-00126(3.7K) or lower, allow 1 cm or more clearance.

\*2 When using the FR-A820-01250(22K) or lower and FR-A840-00620(22K) or lower at the surrounding air temperature of 40°C or less (30°C or less for the SLD rated inverter), inverters can be mounted side by side without leaving any clearance.

\*3 There needs to be a space of at least 30 cm in front of the inverter to replace the cooling fan of the FR-A840-04320(160K) or higher. Refer to [page 816](#) for fan replacement.

## ◆ Installation orientation of the inverter

Install the inverter on a wall as specified. Do not mount it horizontally or in any other way.

## ◆ Above the inverter

Heat is blown up from inside the inverter by the small fan built in the unit. Any equipment placed above the inverter should be heat resistant.

## ◆ Arrangement of multiple inverters

When multiple inverters are placed in the same enclosure, generally arrange them horizontally as shown in the figure (a). When it is inevitable to arrange them vertically to minimize space, take such measures as to provide guides between the inverters since heat generated in the inverters in bottom row can increase the temperatures in the inverters in top row, causing inverter failures.

When installing multiple inverters, fully take measures to prevent the surrounding air temperature of the inverter from being higher than the permissible value by providing ventilation or increasing the enclosure size.

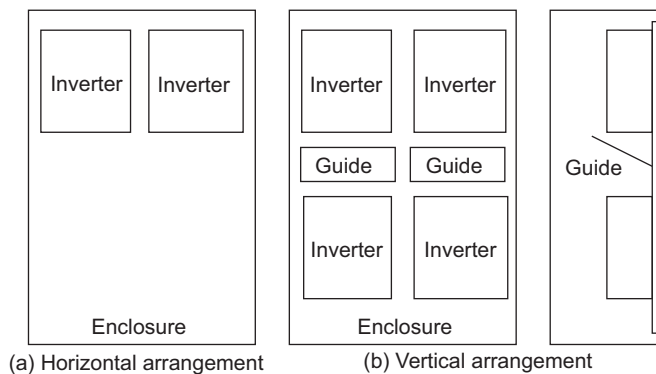

Arrangement of multiple inverters



## ◆ Arrangement of the ventilation fan and inverter

Heat generated in the inverter is blown up from the bottom of the unit as warm air by the cooling fan. When installing a ventilation fan for that heat, determine the place of ventilation fan installation after fully considering an air flow. (Air passes through areas of low resistance. Make an airway and airflow plates to expose the inverter to cool air.)

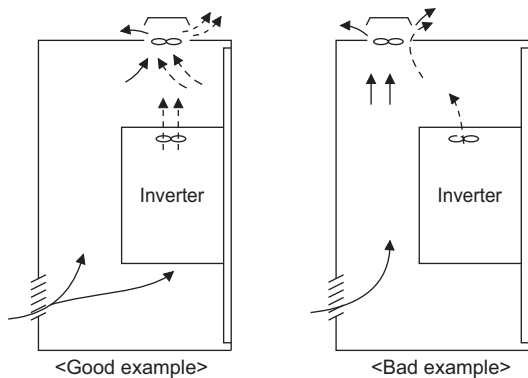

Arrangement of the ventilation fan and inverter

## 2.3.5 Protruding the heat sink through a panel

When encasing the inverter to an enclosure, the heat generated in the enclosure can be greatly reduced by protruding the heat sink of the inverter.

When installing the inverter in a compact enclosure, etc., this installation method is recommended.

### ◆ When using the panel through attachment (FR-A8CN)

For the FR-A820-00105(1.5K) to 04750(90K) and the FR-A840-00023(0.4K) to 03610(132K), a heat sink can be protruded outside the enclosure using a panel through attachment (FR-A8CN). (For the FR-A840-04320(160K) or higher, the attachment is not necessary when the heat sink is to be protruded.)

For a panel cut dimension drawing and an installation procedure of the panel through attachment (FR-A8CN) to the inverter, refer to a manual of FR-A8CN.

### ◆ Protrusion of heat sink for the FR-A840-04320(160K) or higher

#### ■ Panel cutting

Cut the panel of the enclosure according to the inverter capacity.

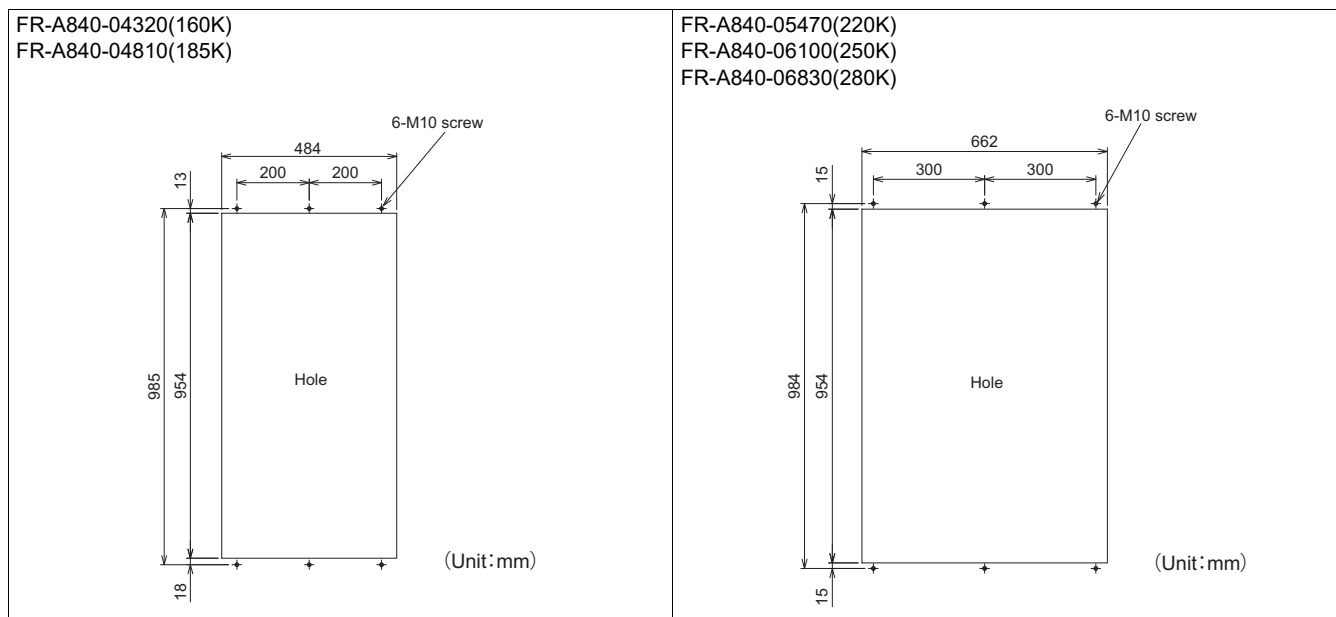

## ■ Mount point change of installation frame from the rear to the front

The upper and lower installation frames are attached on the inverter (one for each position).

Change the mount point of the upper and lower installation frames from the rear to the front as shown in the figure.

When reattaching the installation frames, make sure that the installation orientation is correct.

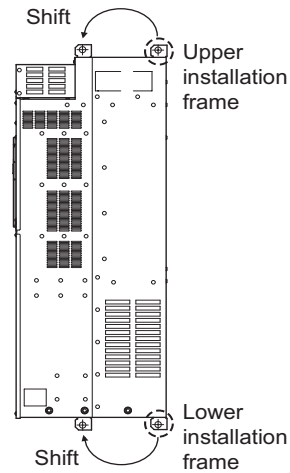

## ■ Installation of the inverter on the enclosure

Push the inverter heat sink part outside the enclosure, and fix the inverter to the panel with upper and lower installation frames.

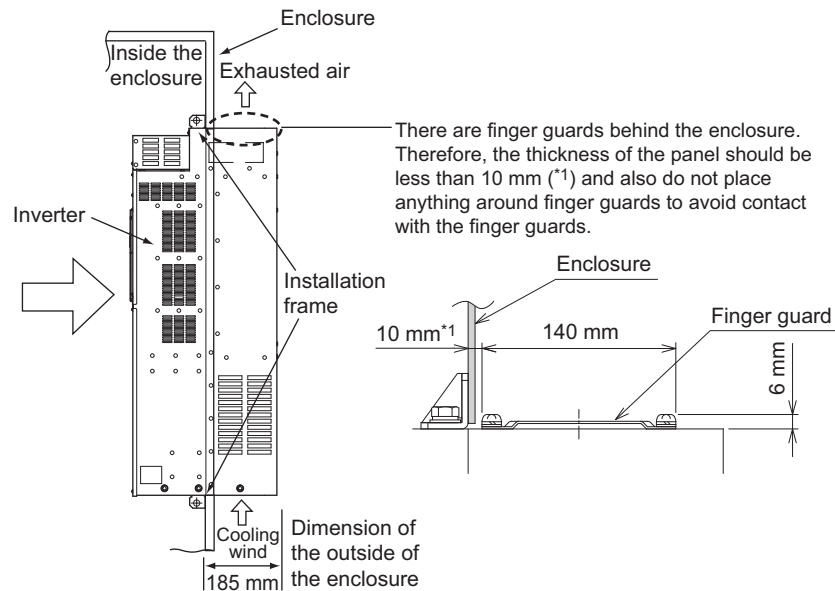

### NOTE

- As the heat sink part protruded through the panel includes a cooling fan, this type of installation is not suitable for the environment of water drops, oil, mist, dust, etc.
- Be careful not to drop screws, dust etc. into the inverter and cooling fan section.

# 2.4 Terminal connection diagrams

## ◆ Type FM

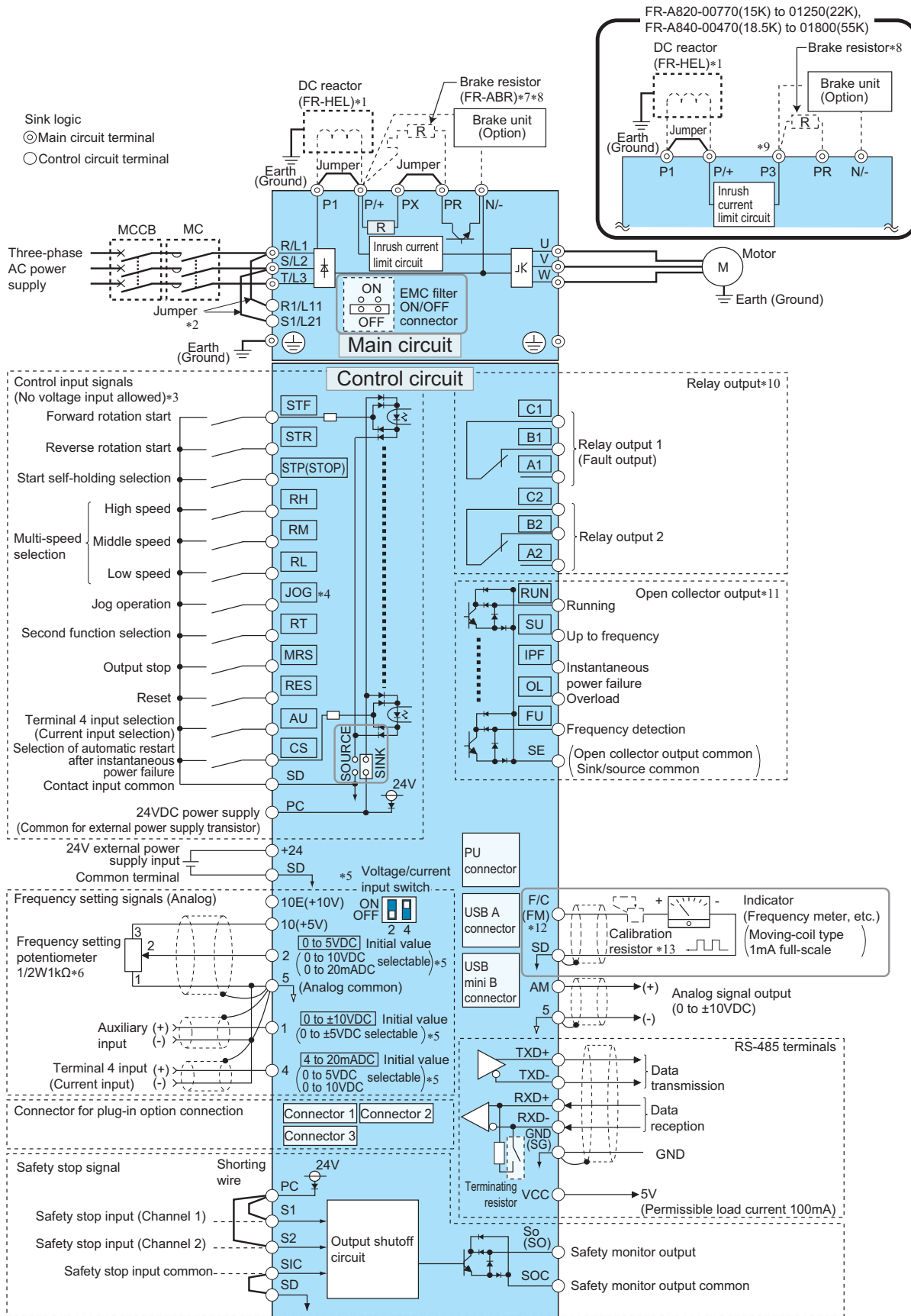

- \*1 For the FR-A820-03800(75K) or higher, the FR-A840-02160(75K) or higher, or whenever a 75 kW or higher motor is used, always connect a DC reactor (FR-HEL), which is available as an option. Refer to [page 826](#) to select the right DC reactor according to the applicable motor capacity. When a DC reactor is connected to the FR-A820-03160(55K) or lower or the FR-A840-01800(55K) or lower, if a jumper is installed across terminals P1 and P/+, remove the jumper before installing the DC reactor. (The jumper is not installed for the FR-A820-03800(75K) or higher and the FR-A840-02160(75K) or higher.)
- \*2 When using separate power supply for the control circuit, remove the jumper between R1/L11 and S1/L21.
- \*3 The function of these terminals can be changed using the Input terminal function selection (**Pr.178 to Pr.189**). (Refer to [page 521](#).)
- \*4 Terminal JOG is also used as a pulse train input terminal. Use **Pr.291** to choose JOG or pulse.
- \*5 Terminal input specifications can be changed by analog input specification switchover (**Pr.73, Pr.267**). To input a voltage, set the corresponding switch of the voltage/current input selection switch assembly to the OFF position. To input a current, set the switch to the ON position. Terminals 10 and 2 are also used as a PTC input terminal (**Pr.561**). (Refer to [page 421](#).)
- \*6 It is recommended to use 2 W 1 k $\Omega$  when the frequency setting signal is changed frequently.
- \*7 Remove the jumper between terminals PR and PX to connect the brake resistor. (FR-A820-00490(7.5K) or lower and FR-A840-00250(7.5K) or lower).
- \*8 Connect a brake resistor across terminals P/+ (P3) and PR. (Terminal PR is equipped in the FR-A820-00046(0.4K) to 01250(22K), and FR-A840-00023(0.4K) to 01800(55K).) Install a thermal relay to prevent overheating and damage of brake resistors. (Refer to [page 97](#).)
- \*9 Do not connect the DC power supply (under DC feeding mode) to terminal P3.
- \*10 The function of these terminals can be changed using the Output terminal function selection (**Pr.195 or Pr.196**). (Refer to [page 473](#).)
- \*11 The function of these terminals can be changed using the Output terminal function selection (**Pr.190 to Pr.194**). (Refer to [page 473](#).)
- \*12 Terminal FM can be used to output pulse trains as open collector output by setting **Pr.291**.
- \*13 Not required when calibrating the scale with the operation panel.

## NOTE

- To prevent a malfunction due to noise, keep the signal cables 10 cm or more away from the power cables. Also, keep the cables of the main circuit for input and output separated.
- After wiring, wire offcuts must not be left in the inverter.  
Wire offcuts can cause a fault, failure or malfunction. Always keep the inverter clean.  
When drilling mounting holes in an enclosure etc., take caution not to allow chips and other foreign matter to enter the inverter.
- Set the switches of the voltage/current input selection switch assembly correctly. Incorrect setting may cause a fault, failure or malfunction.

# ◆ Type CA

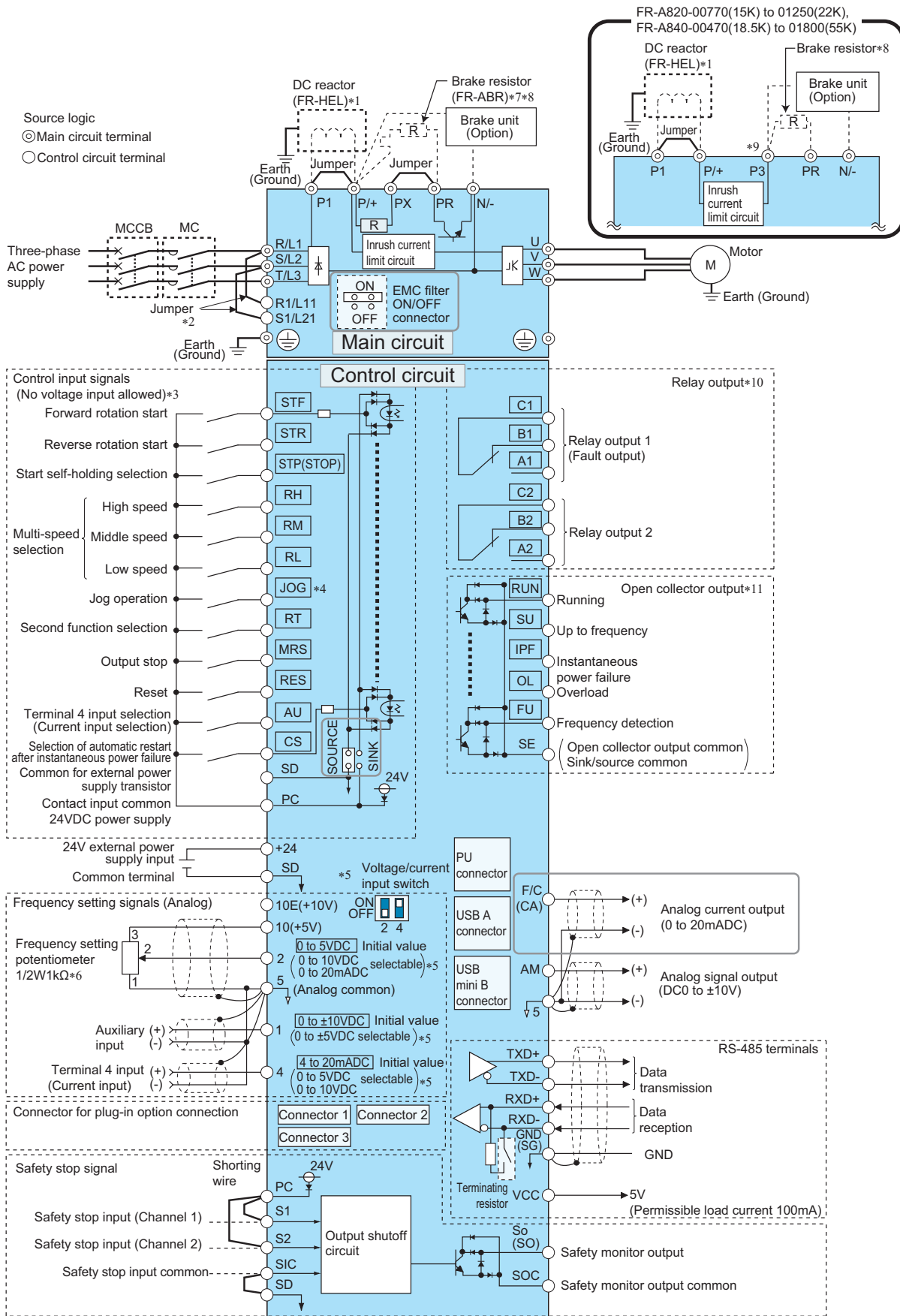

- \*1 For the FR-A820-03800(75K) or higher, the FR-A840-02160(75K) or higher, or whenever a 75 kW or higher motor is used, always connect a DC reactor (FR-HEL), which is available as an option. Refer to [page 826](#) to select the right DC reactor according to the applicable motor capacity. When a DC reactor is connected to the FR-A820-03160(55K) or lower or the FR-A840-01800(55K) or lower, if a jumper is installed across terminals P1 and P/+, remove the jumper before installing the DC reactor. (The jumper is not installed for the FR-A820-03800(75K) or higher and the FR-A840-02160(75K) or higher.)
- \*2 When using separate power supply for the control circuit, remove the jumper between R1/L11 and S1/L21.
- \*3 The function of these terminals can be changed using the Input terminal function selection (**Pr.178 to Pr.189**). (Refer to [page 521](#).)
- \*4 Terminal JOG is also used as a pulse train input terminal. Use **Pr.291** to choose JOG or pulse.
- \*5 Terminal input specifications can be changed by analog input specification switchover (**Pr.73, Pr.267**). To input a voltage, set the corresponding switch of the voltage/current input selection switch assembly to the OFF position. To input a current, set the switch to the ON position. Terminals 10 and 2 are also used as a PTC input terminal (**Pr.561**). (Refer to [page 421](#).)
- \*6 It is recommended to use 2 W 1 k $\Omega$  when the frequency setting signal is changed frequently.
- \*7 Remove the jumper between terminals PR and PX to connect the brake resistor. (FR-A820-00490(7.5K) or lower and FR-A840-00250(7.5K) or lower).
- \*8 Connect a brake resistor across terminals P/+ (P3) and PR. (Terminal PR is equipped in the FR-A820-00046(0.4K) to 01250(22K), and FR-A840-00023(0.4K) to 01800(55K).) Install a thermal relay to prevent overheating and damage of brake resistors. (Refer to [page 97](#).)
- \*9 Do not connect the DC power supply (under DC feeding mode) to terminal P3.
- \*10 The function of these terminals can be changed using the Output terminal function selection (**Pr.195 or Pr.196**). (Refer to [page 473](#).)
- \*11 The function of these terminals can be changed with the output terminal assignment (**Pr.190 to Pr.194**). (Refer to [page 473](#).)

## NOTE

- To prevent a malfunction due to noise, keep the signal cables 10 cm or more away from the power cables. Also, keep the cables of the main circuit for input and output separated.
- After wiring, wire offcuts must not be left in the inverter.  
Wire offcuts can cause a fault, failure or malfunction. Always keep the inverter clean.  
When drilling mounting holes in an enclosure etc., take caution not to allow chips and other foreign matter to enter the inverter.
- Set the switches of the voltage/current input selection switch assembly correctly. Incorrect setting may cause a fault, failure or malfunction.

# ◆ Type FM (FR-A800-GF)

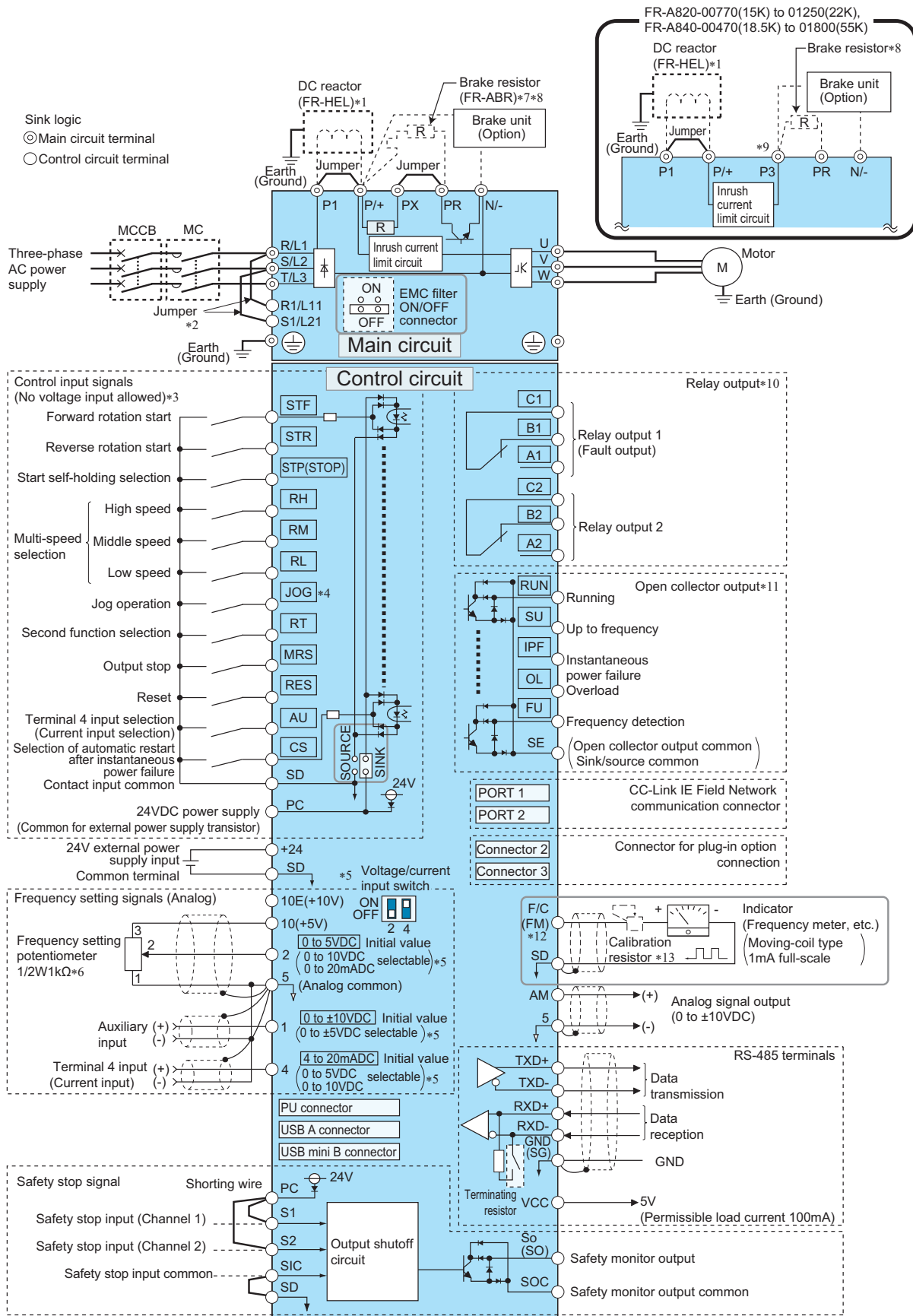

\*1 For the FR-A820-03800(75K) or higher, the FR-A840-02160(75K) or higher, or whenever a 75 kW or higher motor is used, always connect a DC reactor (FR-HEL), which is available as an option. Refer to page 826 to select the right DC reactor according to the applicable motor capacity. When a DC reactor is connected to the FR-A820-03160(55K) or lower or the FR-A840-01800(55K) or lower, if a jumper is installed across terminals P1 and P/+, remove the jumper before installing the DC reactor. (The jumper is not installed for the FR-A820-03800(75K) or higher and the FR-A840-02160(75K) or higher.)

- \*2 When using separate power supply for the control circuit, remove the jumper between R1/L11 and S1/L21.
- \*3 The function of these terminals can be changed using the Input terminal function selection (**Pr.178 to Pr.189**). (Refer to [page 521](#).)
- \*4 Terminal JOG is also used as a pulse train input terminal. Use **Pr.291** to choose JOG or pulse.
- \*5 Terminal input specifications can be changed by analog input specification switchover (**Pr.73, Pr.267**). To input a voltage, set the corresponding switch of the voltage/current input selection switch assembly to the OFF position. To input a current, set the switch to the ON position. Terminals 10 and 2 are also used as a PTC input terminal (**Pr.561**). (Refer to [page 421](#).)
- \*6 It is recommended to use 2 W 1 k $\Omega$  when the frequency setting signal is changed frequently.
- \*7 Remove the jumper between terminals PR and PX to connect the brake resistor. (FR-A820-00490(7.5K) or lower and FR-A840-00250(7.5K) or lower).
- \*8 Connect a brake resistor across terminals P/+ (P3) and PR. (Terminal PR is equipped in the FR-A820-00046(0.4K) to 01250(22K), and FR-A840-00023(0.4K) to 01800(55K).) Install a thermal relay to prevent overheating and damage of brake resistors. (Refer to [page 97](#).)
- \*9 Do not connect the DC power supply (under DC feeding mode) to terminal P3.
- \*10 The function of these terminals can be changed using the Output terminal function selection (**Pr.195 or Pr.196**). (Refer to [page 473](#).)
- \*11 The function of these terminals can be changed using the Output terminal function selection (**Pr.190 to Pr.194**). (Refer to [page 473](#).)
- \*12 Terminal FM can be used to output pulse trains as open collector output by setting **Pr.291**.
- \*13 Not required when calibrating the scale with the operation panel.

**NOTE**

- To prevent a malfunction due to noise, keep the signal cables 10 cm or more away from the power cables. Also, keep the cables of the main circuit for input and output separated.
- After wiring, wire offcuts must not be left in the inverter.  
Wire offcuts can cause a fault, failure or malfunction. Always keep the inverter clean.  
When drilling mounting holes in an enclosure etc., take caution not to allow chips and other foreign matter to enter the inverter.
- Set the switches of the voltage/current input selection switch assembly correctly. Incorrect setting may cause a fault, failure or malfunction.



# ◆ Type CA (FR-A800-GF)

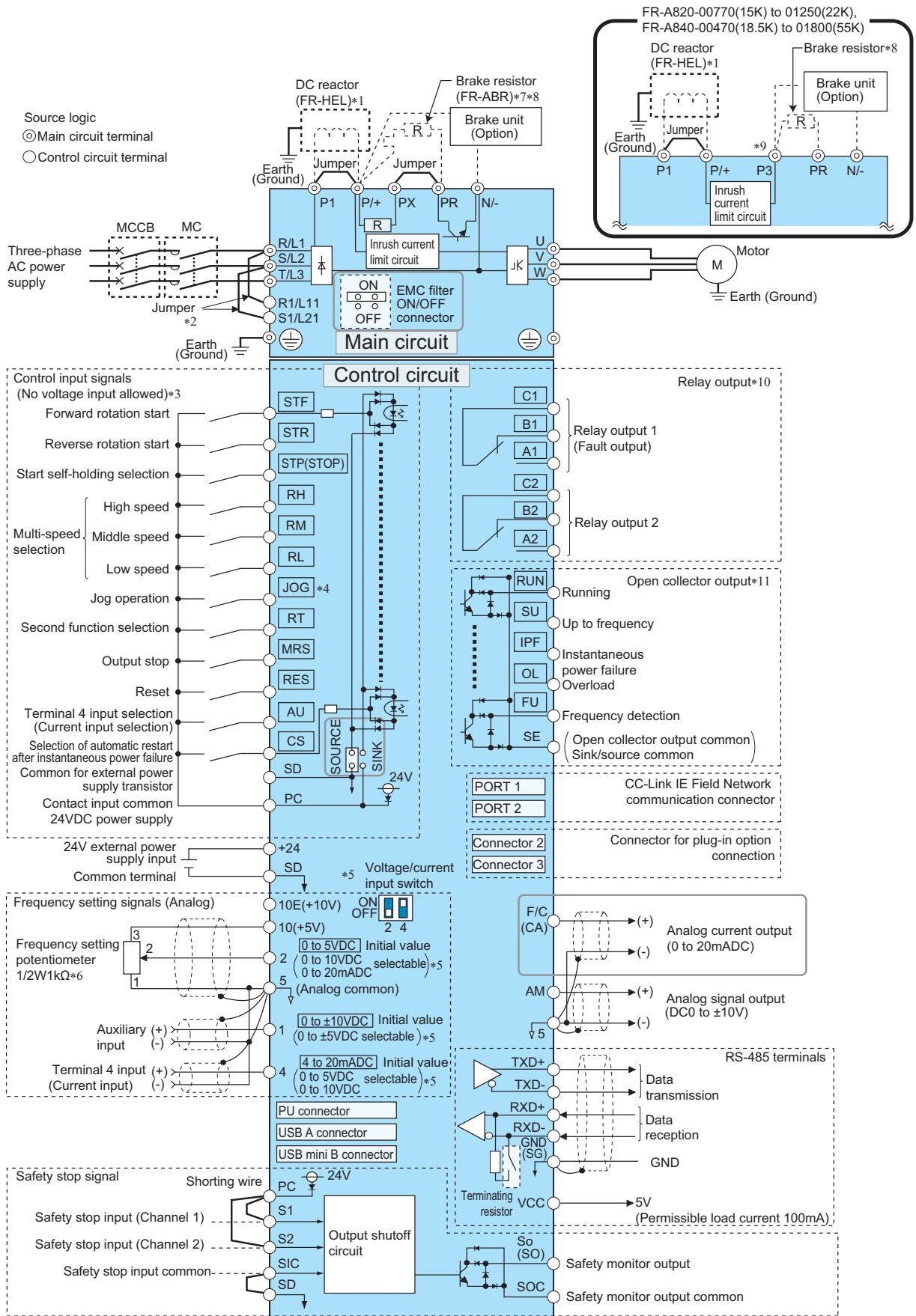

- \*1 For the FR-A820-03800(75K) or higher, the FR-A840-02160(75K) or higher, or whenever a 75 kW or higher motor is used, always connect a DC reactor (FR-HEL), which is available as an option. Refer to [page 826](#) to select the right DC reactor according to the applicable motor capacity. When a DC reactor is connected to the FR-A820-03160(55K) or lower or the FR-A840-01800(55K) or lower, if a jumper is installed across terminals P1 and P/+, remove the jumper before installing the DC reactor. (The jumper is not installed for the FR-A820-03800(75K) or higher and the FR-A840-02160(75K) or higher.)
- \*2 When using separate power supply for the control circuit, remove the jumper between R1/L11 and S1/L21.
- \*3 The function of these terminals can be changed using the Input terminal function selection (**Pr.178 to Pr.189**). (Refer to [page 521](#).)
- \*4 Terminal JOG is also used as a pulse train input terminal. Use **Pr.291** to choose JOG or pulse.
- \*5 Terminal input specifications can be changed by analog input specification switchover (**Pr.73, Pr.267**). To input a voltage, set the corresponding switch of the voltage/current input selection switch assembly to the OFF position. To input a current, set the switch to the ON position. Terminals 10 and 2 are also used as a PTC input terminal (**Pr.561**). (Refer to [page 421](#).)
- \*6 It is recommended to use 2 W 1 k $\Omega$  when the frequency setting signal is changed frequently.
- \*7 Remove the jumper between terminals PR and PX to connect the brake resistor. (FR-A820-00490(7.5K) or lower and FR-A840-00250(7.5K) or lower).
- \*8 Connect a brake resistor across terminals P/+ (P3) and PR. (Terminal PR is equipped in the FR-A820-00046(0.4K) to 01250(22K), and FR-A840-00023(0.4K) to 01800(55K).) Install a thermal relay to prevent overheating and damage of brake resistors. (Refer to [page 97](#).)
- \*9 Do not connect the DC power supply (under DC feeding mode) to terminal P3.
- \*10 The function of these terminals can be changed using the Output terminal function selection (**Pr.195 or Pr.196**). (Refer to [page 473](#).)
- \*11 The function of these terminals can be changed with the output terminal assignment (**Pr.190 to Pr.194**). (Refer to [page 473](#).)

## NOTE

- To prevent a malfunction due to noise, keep the signal cables 10 cm or more away from the power cables. Also, keep the cables of the main circuit for input and output separated.
- After wiring, wire offcuts must not be left in the inverter.  
Wire offcuts can cause a fault, failure or malfunction. Always keep the inverter clean.  
When drilling mounting holes in an enclosure etc., take caution not to allow chips and other foreign matter to enter the inverter.
- Set the switches of the voltage/current input selection switch assembly correctly. Incorrect setting may cause a fault, failure or malfunction.

## 2.5 Main circuit terminals

### 2.5.1 Details on the main circuit terminals

Terminal symbol	Terminal name	Terminal function description	Refer to page
R/L1, S/L2, T/L3	AC power input	Connect these terminals to the commercial power supply. Do not connect anything to these terminals when using the high power factor converter (FR-HC2), multifunction regeneration converter (FR-XC) <sup>*1</sup> , or power regeneration common converter (FR-CV).	—
U, V, W	Inverter output	Connect these terminals to a three-phase squirrel cage motor or a PM motor.	—
R1/L11, S1/L21	Power supply for the control circuit	Connected to the AC power supply terminals R/L1 and S/L2. To retain the fault display and fault output, or to use the high power factor converter (FR-HC2), multifunction regeneration converter (FR-XC) <sup>*1</sup> , or power regeneration common converter (FR-CV), remove the jumpers across terminals R/L1 and R1/L11 and across S/L2 and S1/L21, and supply external power to these terminals. The power capacity necessary when separate power is supplied from R1/L11 and S1/L21 differs according to the inverter capacity. FR-A820-00630(11K) or lower, FR-A840-00380(15K) or lower: 60 VA FR-A820-00770(15K) or higher, FR-A840-00470(18.5K) or higher: 80 VA	77
P/+, PR	Brake resistor connection for FR-A820-00630(11K) or lower, or FR-A840-00380(15K) or lower	Connect an optional brake resistor (FR-ABR) across terminals P/+ and PR. Remove the jumper across terminals PR and PX for the inverter capacity that has terminal PX. Connecting a brake resistor increases the regenerative braking capability.	97
P3, PR	Brake resistor connection for FR-A820-00770(15K) to 01250(22K), or FR-A840-00470(18.5K) to 01800(55K)	Connect an optional brake resistor across terminals P3 and PR. Connecting a brake resistor increases the regenerative braking capability.	
P/+, N/-	Brake unit connection	Connect the brake unit (FR-BU2, FR-BU, BU), power regeneration common converter (FR-CV), power regeneration converter (MT-RC), high power factor converter (FR-HC2), multifunction regeneration converter (FR-XC), or DC power supply (under DC feeding mode). When connecting multiple inverters, FR-A820-00770(15K) to 01250(22K) or FR-A840-00470(18.5K) to 01800(55K), in parallel using the FR-CV, FR-HC2, or FR-XC <sup>*1</sup> , always use either terminal P/+ or P3 for the connection. (Do not use terminals P/+ and P3 together.) Do not connect the DC power supply between terminals P3 and N/-. Use terminals P/+ and N/- for DC feeding.	100
P/+, P1	DC reactor connection for FR-A820-03160(55K) or lower, or FR-A840-01800(55K) or lower	Remove the jumper across terminals P/+ and P1, and connect a DC reactor. When a DC reactor is not connected, the jumper across terminals P/+ and P1 should not be removed. When using a motor with a capacity of 75 kW or higher, always connect a DC reactor, which is available as an option.	109
	DC reactor connection for FR-A820-03800(75K) or higher, or FR-A840-02160(75K) or higher	Always connect a DC reactor, which is available as an option.	
PR, PX	Built-in brake circuit connection	When the jumper is connected across terminals PX and PR (initial status), the built-in brake circuit is valid. The built-in brake circuit is equipped in the FR-A820-00490(7.5K) or lower and FR-A840-00250(7.5K) or lower.	—
	Earth (ground)	For earthing (grounding) the inverter chassis. Be sure to earth (ground) the inverter.	67

\*1 Available when used in the common bus regeneration mode

**NOTE**

- When connecting an optional brake resistor (FR-ABR) or a brake unit (FR-BU2, FR-BU, BU), remove the jumpers across terminals PR and PX. For the details, refer to [page 97](#).

## 2.5.2 Main circuit terminal layout and wiring to power supply and motor

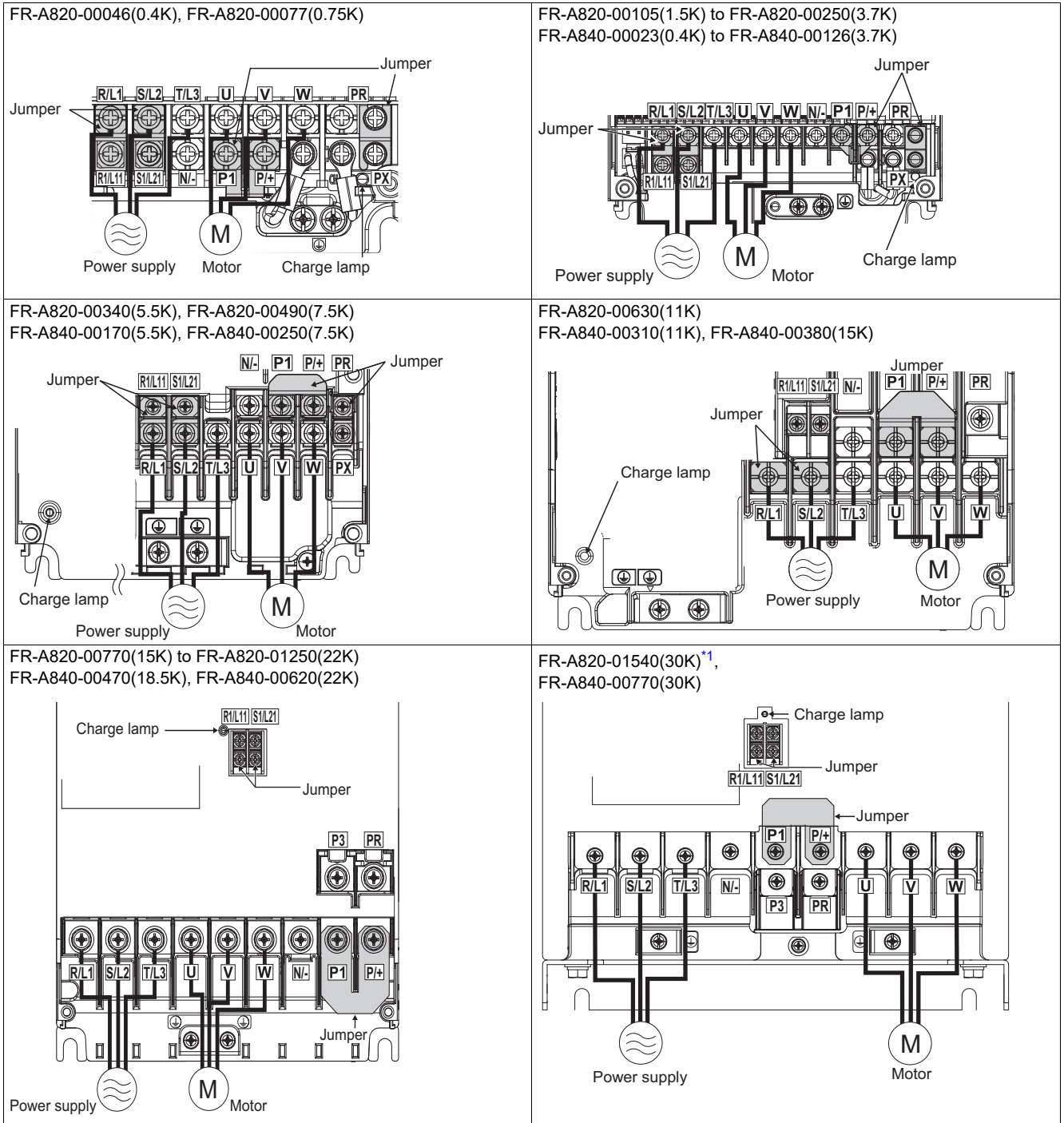

FR-A820-01870(37K), FR-A820-02330(45K)

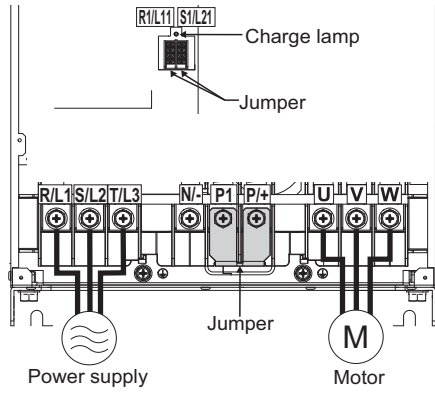

FR-A820-03160(55K)

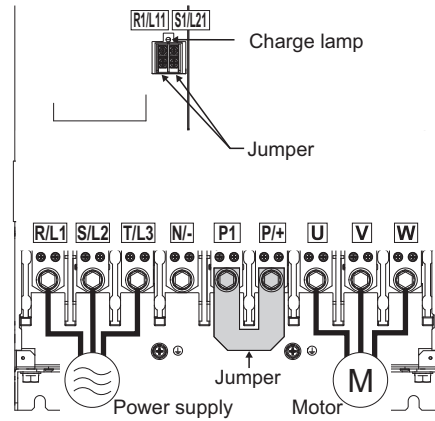

FR-A820-03800(75K), FR-A820-04750(90K)

FR-A840-03250(110K) to FR-A840-04810(185K)\*2

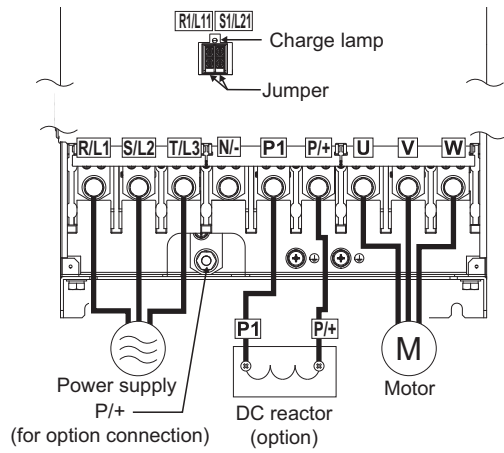

FR-A840-00930(37K) to FR-A840-01800(55K)

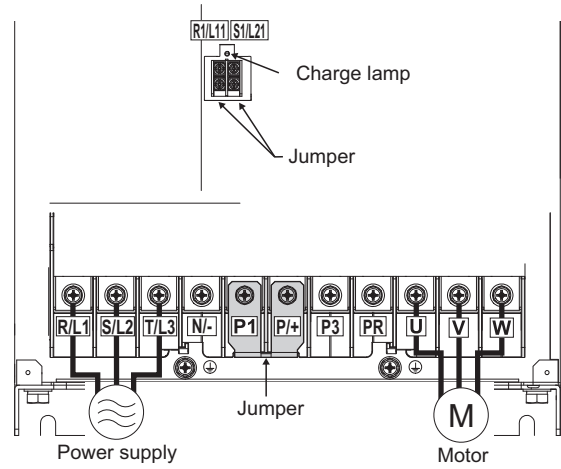

FR-A840-02160(75K), FR-A840-02600(90K)

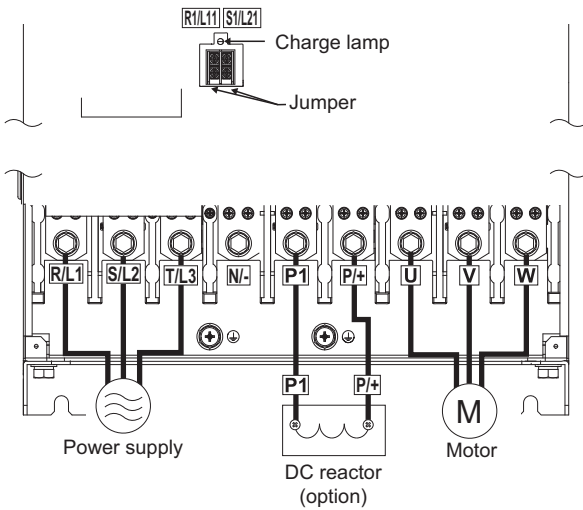

FR-A840-05470(220K) to FR-A840-06830(280K)

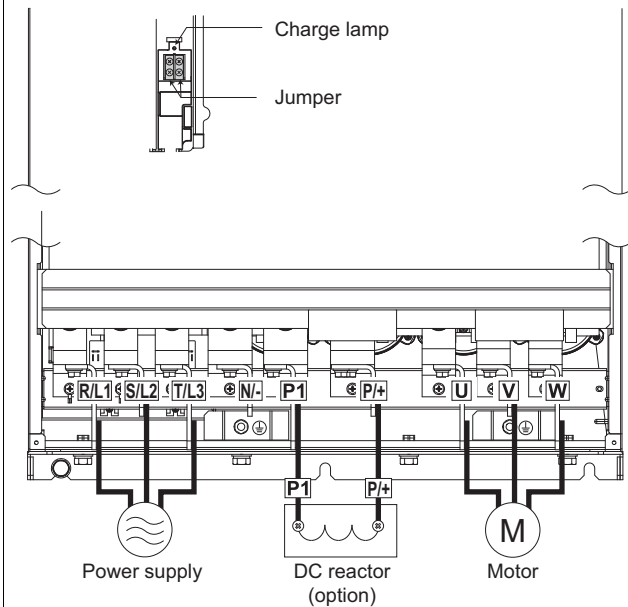

\*1 Terminals P3 and PR of the FR-A820-01540(30K) are not provided with a screw. Do not connect anything to them.

\*2 When an option other than the DC reactor must be connected to terminal P/+, use terminal P/+ (for option connection).

**NOTE**

- Make sure the power cables are connected to the R/L1, S/L2, and T/L3. (Phase need not be matched.) Never connect the power cable to the U, V, and W of the inverter. Doing so will damage the inverter.
- Connect the motor to U, V, and W. (The phases must be matched.)
- When wiring the inverter main circuit conductor of the FR-A840-05470(220K) or higher, tighten a nut from the right side of the conductor. When wiring two cables, place cables on both sides of the conductor. For wiring, use bolts (nuts) provided with the inverter. (Refer to the following figure.)

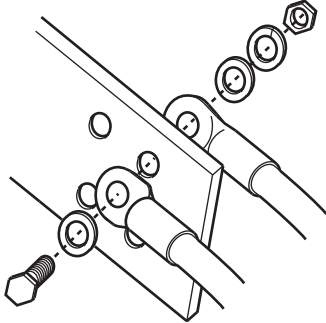
**■ Handling of the wiring cover**

(FR-A820-00630(11K) to 01250(22K), FR-A840-00310(11K) to 00620(22K))

For the hook of the wiring cover, cut off the necessary parts using a pair of needle-nose pliers etc.

**NOTE**

- Cut off the same number of lugs as wires. If parts where no wire is put through have been cut off (10 mm or more), protective structure (IEC 60529) becomes an open type (IP00).

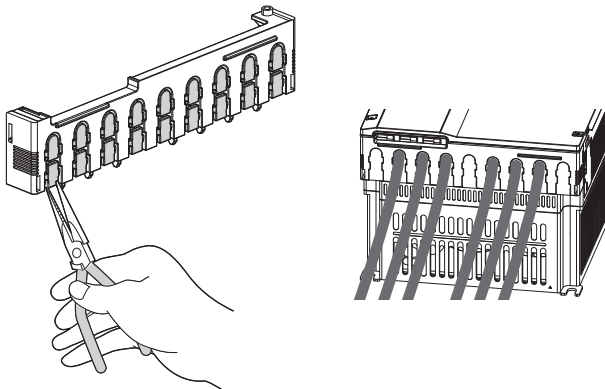

## 2.5.3 Recommended cables and wiring length

Select a recommended size cable to ensure that the voltage drop ratio is within 2%.

If the wiring distance is long between the inverter and motor, the voltage drop in the main circuit will cause the motor torque to decrease especially at a low speed.

The following tables show the recommended cable size for cables that are 20 m in length.

## ◆ For the ND rating

- 200 V class (220 V input power supply, without a power factor improving AC or DC reactor)

Applicable inverter model FR-A820-□	Terminal screw size <sup>4</sup>	Tightening torque (N·m)	Crimp terminal		Cable gauge								
					HIV cables, etc. (mm <sup>2</sup> ) <sup>*1</sup>				AWG/MCM <sup>*2</sup>		PVC cables, etc. (mm <sup>2</sup> ) <sup>*3</sup>		
			R/L1, S/L2, T/L3	U, V, W	R/L1, S/L2, T/L3	U, V, W	P/+, P1	Earthing (grounding) cable	R/L1, S/L2, T/L3	U, V, W	R/L1, S/L2, T/L3	U, V, W	Earthing (grounding) cable
00046(0.4K) to 00167(2.2K)	M4	1.5	2-4	2-4	2	2	2	2	14	14	2.5	2.5	2.5
00250(3.7K)	M4	1.5	5.5-4	5.5-4	3.5	3.5	3.5	3.5	12	12	4	4	4
00340(5.5K)	M5 (M4)	2.5	5.5-5	5.5-5	5.5	5.5	5.5	5.5	10	10	6	6	6
00490(7.5K)	M5 (M4)	2.5	14-5	8-5	14	8	14	5.5	6	8	16	10	16
00630(11K)	M5	2.5	14-5	14-5	14	14	14	8	6	6	16	16	16
00770(15K)	M6	4.4	22-6	22-6	22	22	22	14	4	4	25	25	16
00930(18.5K)	M8 (M6)	7.8	38-8	22-8	38	22	38	14	2	4	35	25	25
01250(22K)	M8 (M6)	7.8	38-8	38-8	38	38	38	22	2	2	35	35	25
01540(30K)	M8 (M6)	7.8	60-8	60-8	60	60	60	22	1/0	1/0	50	50	25
01870(37K)	M10 (M8)	26.5	80-10	60-10	80	60	80	22	3/0	1/0	70	70	35
02330(45K)	M10 (M8)	26.5	100-10	100-10	100	100	100	38	4/0	4/0	95	95	50
03160(55K)	M12 (M8)	46	100-12	100-12	100	100	100	38	4/0	4/0	95	95	50

- 200 V class (220 V input power supply, with a power factor improving AC or DC reactor)

Applicable inverter model FR-A820-□	Terminal screw size <sup>4</sup>	Tightening torque (N·m)	Crimp terminal		Cable gauge								
					HIV cables, etc. (mm <sup>2</sup> ) <sup>*1</sup>				AWG/MCM <sup>*2</sup>		PVC cables, etc. (mm <sup>2</sup> ) <sup>*3</sup>		
			R/L1, S/L2, T/L3	U, V, W	R/L1, S/L2, T/L3	U, V, W	P/+, P1	Earthing (grounding) cable	R/L1, S/L2, T/L3	U, V, W	R/L1, S/L2, T/L3	U, V, W	Earthing (grounding) cable
00046(0.4K) to 00167(2.2K)	M4	1.5	2-4	2-4	2	2	2	2	14	14	2.5	2.5	2.5
00250(3.7K)	M4	1.5	5.5-4	5.5-4	3.5	3.5	3.5	3.5	12	12	4	4	4
00340(5.5K)	M5 (M4)	2.5	5.5-5	5.5-5	5.5	5.5	5.5	5.5	10	10	6	6	6
00490(7.5K)	M5 (M4)	2.5	14-5	8-5	14	8	14	5.5	8	8	10	10	10
00630(11K)	M5	2.5	14-5	14-5	14	14	14	8	6	6	16	16	16
00770(15K)	M6	4.4	22-6	22-6	22	22	22	14	4	4	25	25	16
00930(18.5K)	M8 (M6)	7.8	22-8	22-8	22	22	38	14	4	4	25	25	16
01250(22K)	M8 (M6)	7.8	38-8	38-8	38	38	38	22	2	2	35	35	25
01540(30K)	M8 (M6)	7.8	60-8	60-8	60	60	60	22	1/0	1/0	50	50	25
01870(37K)	M10 (M8)	26.5	60-10	60-10	60	60	80	22	1/0	1/0	70	70	35
02330(45K)	M10 (M8)	26.5	100-10	100-10	100	100	100	38	4/0	4/0	95	95	50
03160(55K)	M12 (M8)	46	100-12	100-12	100	100	100	38	4/0	4/0	95	95	50
03800(75K)	M12 (M8)	46	150-12	150-12	125	125	125	38	250	250	120	120	—
04750(90K)	M12 (M8)	46	150-12	150-12	150	150	150	38	300	300	150	150	—

- 400 V class (440 V input power supply, without a power factor improving AC or DC reactor)

Applicable inverter model FR-A840-□	Terminal screw size <sup>4</sup>	Tightening torque (N·m)	Crimp terminal		Cable gauge								
					HIV cables, etc. (mm <sup>2</sup> ) <sup>*1</sup>				AWG/MCM <sup>*2</sup>		PVC cables, etc. (mm <sup>2</sup> ) <sup>*3</sup>		
			R/L1, S/L2, T/L3	U, V, W	R/L1, S/L2, T/L3	U, V, W	P/+, P1	Earthing (grounding) cable	R/L1, S/L2, T/L3	U, V, W	R/L1, S/L2, T/L3	U, V, W	Earthing (grounding) cable
00023(0.4K) to 00126(3.7K)	M4	1.5	2-4	2-4	2	2	2	2	14	14	2.5	2.5	2.5
00170(5.5K)	M4	1.5	2-4	2-4	2	2	3.5	3.5	12	14	2.5	2.5	4
00250(7.5K)	M4	1.5	5.5-4	5.5-4	3.5	3.5	3.5	3.5	12	12	4	4	4
00310(11K)	M5	2.5	5.5-5	5.5-5	5.5	5.5	5.5	5.5	10	10	6	6	10
00380(15K)	M5	2.5	8-5	5.5-5	8	5.5	8	5.5	8	10	10	6	10
00470(18.5K)	M6	4.4	14-6	8-6	14	8	14	8	6	8	16	10	16
00620(22K)	M6	4.4	14-6	14-6	14	14	22	14	6	6	16	16	16
00770(30K)	M6	4.4	22-6	22-6	22	22	22	14	4	4	25	25	16
00930(37K)	M8	7.8	22-8	22-8	22	22	22	14	4	4	25	25	16
01160(45K)	M8	7.8	38-8	38-8	38	38	38	22	1	2	50	50	25
01800(55K)	M8	7.8	60-8	60-8	60	60	60	22	1/0	1/0	50	50	25



- 400 V class (440 V input power supply, with a power factor improving AC or DC reactor)

Applicable inverter model FR-A840-□	Terminal screw size <sup>4</sup>	Tightening torque (N·m)	Crimp terminal		Cable gauge								
					HIV cables, etc. (mm <sup>2</sup> ) <sup>*1</sup>				AWG/MCM <sup>*2</sup>		PVC cables, etc. (mm <sup>2</sup> ) <sup>*3</sup>		
			R/L1, S/L2, T/L3	U, V, W	R/L1, S/L2, T/L3	U, V, W	P/+, P1	Earthing (grounding) cable	R/L1, S/L2, T/L3	U, V, W	R/L1, S/L2, T/L3	U, V, W	Earthing (grounding) cable
00023(0.4K) to 00126(3.7K)	M4	1.5	2-4	2-4	2	2	2	2	14	14	2.5	2.5	2.5
00170(5.5K)	M4	1.5	2-4	2-4	2	2	3.5	3.5	12	14	2.5	2.5	4
00250(7.5K)	M4	1.5	5.5-4	5.5-4	3.5	3.5	3.5	3.5	12	12	4	4	4
00310(11K)	M5	2.5	5.5-5	5.5-5	5.5	5.5	5.5	5.5	10	10	6	6	10
00380(15K)	M5	2.5	5.5-5	5.5-5	5.5	5.5	8	5.5	10	10	6	6	10
00470(18.5K)	M6	4.4	8-6	8-6	8	8	14	8	8	8	10	10	16
00620(22K)	M6	4.4	14-6	14-6	14	14	22	14	6	6	16	16	16
00770(30K)	M6	4.4	22-6	22-6	22	22	22	14	4	4	25	25	16
00930(37K)	M8	7.8	22-8	22-8	22	22	22	14	4	4	25	25	16
01160(45K)	M8	7.8	38-8	38-8	38	38	38	22	2	2	50	50	25
01800(55K)	M8	7.8	60-8	60-8	60	60	60	22	1/0	1/0	50	50	25
02160(75K)	M10	26.5	60-10	60-10	60	60	60	22	1/0	1/0	50	50	25
02600(90K)	M10	26.5	60-10	60-10	60	60	80	22	3/0	3/0	50	50	25
03250(110K)	M10 (M12)	26.5	80-10	80-10	80	80	80	22	3/0	3/0	70	70	35
03610(132K)	M10 (M12)	26.5	100-10	100-10	100	100	100	38	4/0	4/0	95	95	50
04320(160K)	M12 (M10)	46	150-12	150-12	125	125	150	38	250	250	120	120	70
04810(185K)	M12 (M10)	46	150-12	150-12	150	150	150	38	300	300	150	150	95
05470(220K)	M12 (M10)	46	100-12	100-12	2×100	2×100	2×100	60	2×4/0	2×4/0	2×95	2×95	95
06100(250K)	M12 (M10)	46	100-12	100-12	2×100	2×100	2×125	60	2×4/0	2×4/0	2×95	2×95	95
06830(280K)	M12 (M10)	46	150-12	150-12	2×125	2×125	2×125	60	2×250	2×250	2×120	2×120	120

\*1 For the FR-A820-03160(55K) or lower and FR-A840-01800(55K) or lower, HIV cable (600 V grade heat-resistant PVC insulated wire) etc. with a continuous maximum permissible temperature of 75°C. It assumes that the cables will be used in a surrounding air temperature of 50°C or less and the wiring distance is 20 m or shorter.

For the FR-A820-03800(75K) or higher, FR-A840-02160(75K) or higher, LMFC (heat resistant flexible cross-linked polyethylene insulated cable) etc. with a continuous maximum permissible temperature of 90°C or more. It is assumed that the cables will be used in a surrounding air temperatures of 50°C or less and housed in an enclosure.

\*2 For all the 200 V class capacities and FR-A840-01160(45K) or lower, THHW cable with a continuous maximum permissible temperature of 75°C. It assumes that the cables will be used in a surrounding air temperature of 40°C or less and the wiring distance is 20 m or shorter.

For the FR-A840-01800(55K) or higher, THHN cable with a continuous maximum permissible temperature of 90°C. It is assumed that the cables will be used in a surrounding air temperatures of 40°C or less and housed in an enclosure.

(For the use in the United States or Canada, refer to "Instructions for UL and cUL" in the Instruction Manual (Startup) or Instruction Manual (Hardware).)

\*3 For the FR-A820-00770(15K) or lower and the FR-A840-01160(45K) or lower, PVC cable with a continuous maximum permissible temperature of 70°C. It assumes that the cables will be used in a surrounding air temperature of 40°C or less and the wiring distance is 20 m or shorter.

For the FR-A820-00930(18.5K) or higher and the FR-A840-01800(55K) or higher, XLPE cable with a continuous maximum permissible temperature of 90°C. It is assumed that the cables will be used in a surrounding air temperatures of 40°C or less and housed in an enclosure. (Selection example mainly for use in Europe.)

\*4 Screws for terminals R/L1, S/L2, T/L3, U, V, W, PR, PX, P/+, N/-, and P1, and the screw for earthing (grounding).

The size of screws for terminals PR and PX on FR-A820-00340(5.5K) and FR-A820-00490(7.5K) is indicated in parentheses.

The size of the earthing (grounding) screw on FR-A820-00930(18.5K) or higher and FR-A840-04320(160K) or higher is indicated in parentheses.

The size of the screw for terminal P/+ for option connection on FR-A840-03250(110K) and FR-A840-03610(132K) is indicated in parentheses.

## ◆ For the SLD rating

- 200 V class (220 V input power supply, without a power factor improving AC or DC reactor)

Applicable inverter model FR-A820-□	Terminal screw size <sup>4</sup>	Tightening torque (N·m)	Crimp terminal		Cable gauge								
					HIV cables, etc. (mm <sup>2</sup> ) <sup>*1</sup>				AWG/MCM <sup>*2</sup>		PVC cables, etc. (mm <sup>2</sup> ) <sup>*3</sup>		
			R/L1, S/L2, T/L3	U, V, W	R/L1, S/L2, T/L3	U, V, W	P/+, P1	Earthing (grounding) cable	R/L1, S/L2, T/L3	U, V, W	R/L1, S/L2, T/L3	U, V, W	Earthing (grounding) cable
00046(0.4K)	M4	1.5	2-4	2-4	2	2	2	2	14	14	2.5	2.5	2.5
00077(0.75K)	M4	1.5	2-4	2-4	2	2	2	2	14	14	2.5	2.5	2.5
00105(1.5K)	M4	1.5	2-4	2-4	2	2	2	2	14	14	2.5	2.5	2.5
00167(2.2K)	M4	1.5	5.5-4	5.5-4	3.5	3.5	3.5	3.5	12	12	4	4	4
00250(3.7K)	M4	1.5	5.5-4	5.5-4	5.5	5.5	5.5	5.5	10	10	6	6	6
00340(5.5K)	M5 (M4)	2.5	14-5	8-5	14	8	14	5.5	6	8	16	10	16
00490(7.5K)	M5 (M4)	2.5	14-5	14-5	14	14	14	8	6	6	16	16	16
00630(11K)	M5	2.5	22-5	22-5	22	22	22	14	4	4	25	25	16



Applicable inverter model FR-A820-[]	Terminal screw size <sup>*4</sup>	Tightening torque (N·m)	Crimp terminal		Cable gauge									
					HIV cables, etc. (mm <sup>2</sup> ) <sup>*1</sup>				AWG/MCM <sup>*2</sup>		PVC cables, etc. (mm <sup>2</sup> ) <sup>*3</sup>			
			R/L1, S/L2, T/L3	U, V, W	R/L1, S/L2, T/L3	U, V, W	P/+, P1	Earthing (grounding) cable	R/L1, S/L2, T/L3	U, V, W	R/L1, S/L2, T/L3	U, V, W	Earthing (grounding) cable	
00770(15K)	M6	4.4	38-6	22-6	38	22	38	14		2	4	50	25	25
00930(18.5K)	M8 (M6)	7.8	38-8	38-8	38	38	38	22		2	2	50	50	25
01250(22K)	M8 (M6)	7.8	60-8	60-8	60	60	60	22		1/0	1/0	50	50	25
01540(30K)	M8 (M6)	7.8	80-8	80-8	80	80	80	22		3/0	3/0	70	70	35
01870(37K)	M10 (M8)	26.5	100-10	100-10	100	100	100	38		4/0	4/0	95	95	50
02330(45K)	M10 (M8)	26.5	100-10	100-10	100	100	100	38		4/0	4/0	95	95	50

- 200 V class (220 V input power supply, with a power factor improving AC or DC reactor)

Applicable inverter model FR-A820-[]	Terminal screw size <sup>*4</sup>	Tightening torque (N·m)	Crimp terminal		Cable gauge									
					HIV cables, etc. (mm <sup>2</sup> ) <sup>*1</sup>				AWG/MCM <sup>*2</sup>		PVC cables, etc. (mm <sup>2</sup> ) <sup>*3</sup>			
			R/L1, S/L2, T/L3	U, V, W	R/L1, S/L2, T/L3	U, V, W	P/+, P1	Earthing (grounding) cable	R/L1, S/L2, T/L3	U, V, W	R/L1, S/L2, T/L3	U, V, W	Earthing (grounding) cable	
00046(0.4K)	M4	1.5	2-4	2-4	2	2	2	2		14	14	2.5	2.5	2.5
00077(0.75K)	M4	1.5	2-4	2-4	2	2	2	2		14	14	2.5	2.5	2.5
00105(1.5K)	M4	1.5	2-4	2-4	2	2	2	2		14	14	2.5	2.5	2.5
00167(2.2K)	M4	1.5	5.5-4	5.5-4	3.5	3.5	3.5	3.5		12	12	4	4	4
00250(3.7K)	M4	1.5	5.5-4	5.5-4	5.5	5.5	5.5	5.5		10	10	6	6	6
00340(5.5K)	M5 (M4)	2.5	8-5	8-5	8	8	14	5.5		8	8	10	10	10
00490(7.5K)	M5 (M4)	2.5	14-5	14-5	14	14	14	8		6	6	16	16	16
00630(11K)	M5	2.5	22-5	22-5	22	22	22	14		4	4	25	25	16
00770(15K)	M6	4.4	22-6	22-6	22	22	38	14		4	4	25	25	25
00930(18.5K)	M8 (M6)	7.8	38-8	38-8	38	38	38	22		2	2	50	50	25
01250(22K)	M8 (M6)	7.8	60-8	60-8	60	60	60	22		1/0	1/0	50	50	25
01540(30K)	M8 (M6)	7.8	80-8	80-8	80	80	80	22		3/0	3/0	70	70	35
01870(37K)	M10 (M8)	26.5	100-10	100-10	100	100	100	38		4/0	4/0	95	95	50
02330(45K)	M10 (M8)	26.5	100-10	100-10	100	100	100	38		4/0	4/0	95	95	50
03160(55K)	M12 (M8)	46	150-12	150-12	125	125	125	38		250	250	120	120	—
03800(75K)	M12 (M8)	46	150-12	150-12	150	150	150	38		2×4/0	2×4/0	2×95	2×95	—
04750(90K)	M12 (M8)	46	100-12	100-12	2×100	2×100	2×100	60		2×4/0	2×4/0	2×95	2×95	—

- 400 V class (440 V input power supply, without a power factor improving AC or DC reactor)

Applicable inverter model FR-A840-[]	Terminal screw size <sup>*4</sup>	Tightening torque (N·m)	Crimp terminal		Cable gauge									
					HIV cables, etc. (mm <sup>2</sup> ) <sup>*1</sup>				AWG/MCM <sup>*2</sup>		PVC cables, etc. (mm <sup>2</sup> ) <sup>*3</sup>			
			R/L1, S/L2, T/L3	U, V, W	R/L1, S/L2, T/L3	U, V, W	P/+, P1	Earthing (grounding) cable	R/L1, S/L2, T/L3	U, V, W	R/L1, S/L2, T/L3	U, V, W	Earthing (grounding) cable	
00023(0.4K)	M4	1.5	2-4	2-4	2	2	2	2		14	14	2.5	2.5	2.5
00038(0.75K)	M4	1.5	2-4	2-4	2	2	2	2		14	14	2.5	2.5	2.5
00052(1.5K)	M4	1.5	2-4	2-4	2	2	2	2		14	14	2.5	2.5	2.5
00083(2.2K)	M4	1.5	2-4	2-4	2	2	2	2		14	14	2.5	2.5	2.5
00126(3.7K)	M4	1.5	2-4	2-4	2	2	3.5	3.5		12	14	2.5	2.5	4
00170(5.5K)	M4	1.5	5.5-4	5.5-4	3.5	3.5	3.5	3.5		12	12	4	4	4
00250(7.5K)	M4	1.5	5.5-4	5.5-4	5.5	5.5	5.5	5.5		10	10	6	6	10
00310(11K)	M5	2.5	8-5	5.5-5	8	5.5	8	5.5		8	10	10	6	10
00380(15K)	M5	2.5	14-5	8-5	14	8	14	8		6	8	16	10	16
00470(18.5K)	M6	4.4	14-6	14-6	14	14	22	14		6	6	16	16	16
00620(22K)	M6	4.4	22-6	22-6	22	22	22	14		4	4	25	25	16
00770(30K)	M6	4.4	22-6	22-6	22	22	22	14		4	4	25	25	16
00930(37K)	M8	7.8	38-8	38-8	38	38	38	22		1	2	50	50	25
01160(45K)	M8	7.8	60-8	60-8	60	60	60	22		1/0	1/0	50	50	25

- 400 V class (440 V input power supply, with a power factor improving AC or DC reactor)

Applicable inverter model FR-A840-[]	Terminal screw size <sup>*4</sup>	Tightening torque (N·m)	Crimp terminal		Cable gauge								
					HIV cables, etc. (mm <sup>2</sup> ) <sup>*1</sup>				AWG/MCM <sup>*2</sup>		PVC cables, etc. (mm <sup>2</sup> ) <sup>*3</sup>		
			R/L1, S/L2, T/L3	U, V, W	R/L1, S/L2, T/L3	U, V, W	P/+, P1	Earthing (grounding) cable	R/L1, S/L2, T/L3	U, V, W	R/L1, S/L2, T/L3	U, V, W	Earthing (grounding) cable
00023(0.4K)	M4	1.5	2-4	2-4	2	2	2	2	14	14	2.5	2.5	2.5
00038(0.75K)	M4	1.5	2-4	2-4	2	2	2	2	14	14	2.5	2.5	2.5
00052(1.5K)	M4	1.5	2-4	2-4	2	2	2	2	14	14	2.5	2.5	2.5
00083(2.2K)	M4	1.5	2-4	2-4	2	2	2	2	14	14	2.5	2.5	2.5
00126(3.7K)	M4	1.5	2-4	2-4	2	2	3.5	3.5	14	14	2.5	2.5	4
00170(5.5K)	M4	1.5	5.5-4	5.5-4	3.5	3.5	3.5	3.5	12	12	4	4	4
00250(7.5K)	M4	1.5	5.5-4	5.5-4	5.5	5.5	5.5	5.5	10	10	6	6	10
00310(11K)	M5	2.5	5.5-5	5.5-5	5.5	5.5	8	5.5	10	10	6	6	10
00380(15K)	M5	2.5	8-5	8-5	8	8	14	8	8	8	10	10	16
00470(18.5K)	M6	4.4	14-6	14-6	14	14	22	14	6	6	16	16	16
00620(22K)	M6	4.4	22-6	22-6	22	22	22	14	4	4	25	25	16
00770(30K)	M6	4.4	22-6	22-6	22	22	22	14	4	4	25	25	16
00930(37K)	M8	7.8	38-8	38-8	38	38	38	22	2	2	50	50	25
01160(45K)	M8	7.8	60-8	60-8	60	60	60	22	1/0	1/0	50	50	25
01800(55K)	M8	7.8	60-8	60-8	60	60	60	22	1/0	1/0	50	50	25
02160(75K)	M10	26.5	80-10	80-10	80	80	80	22	3/0	3/0	70	70	35
02600(90K)	M10	26.5	100-10	100-10	100	100	100	38	4/0	4/0	95	95	50
03250(110K)	M10 (M12)	26.5	150-10	150-10	125	125	150	38	250	250	120	120	70
03610(132K)	M10 (M12)	26.5	150-10	150-10	150	150	150	38	300	300	150	150	95
04320(160K)	M12 (M10)	46	100-12	100-12	2×100	2×100	2×100	60	2×4/0	2×4/0	2×95	2×95	95
04810(185K)	M12 (M10)	46	100-12	100-12	2×100	2×100	2×125	60	2×4/0	2×4/0	2×95	2×95	95
05470(220K)	M12 (M10)	46	150-12	150-12	2×125	2×125	2×125	60	2×250	2×250	2×120	2×120	120
06100(250K)	M12 (M10)	46	150-12	150-12	2×150	2×150	2×150	60	2×300	2×300	2×150	2×150	150
06830(280K)	M12 (M10)	46	150-12	150-12	2×200	2×200	2×200	100	2×350	2×350	2×185	2×185	2×95

\*1 For the FR-A820-03160(55K) or lower and FR-A840-01800(55K) or lower, HIV cable (600 V grade heat-resistant PVC insulated wire) etc. with a continuous maximum permissible temperature of 75°C. It assumes that the cables will be used in a surrounding air temperature of 50°C or less and the wiring distance is 20 m or shorter.

For the FR-A820-03800(75K) or higher, FR-A840-02160(75K) or higher, LMFC (heat resistant flexible cross-linked polyethylene insulated cable) etc. with a continuous maximum permissible temperature of 90°C or more. It is assumed that the cables will be used in a surrounding air temperatures of 50°C or less and housed in an enclosure.

\*2 For all the 200 V class capacities and FR-A840-01160(45K) or lower, THHW cable with a continuous maximum permissible temperature of 75°C. It assumes that the cables will be used in a surrounding air temperature of 40°C or less and the wiring distance is 20 m or shorter.

For the FR-A840-01800(55K) or higher, THHN cable with a continuous maximum permissible temperature of 90°C. It is assumed that the cables will be used in a surrounding air temperatures of 40°C or less and housed in an enclosure.

(For the use in the United States or Canada, refer to "Instructions for UL and cUL" in the Instruction Manual (Startup) or Instruction Manual (Hardware).)

\*3 For the FR-A820-00770(15K) or lower and the FR-A840-01160(45K) or lower, PVC cable with a continuous maximum permissible temperature of 70°C. It assumes that the cables will be used in a surrounding air temperature of 40°C or less and the wiring distance is 20 m or shorter.

For the FR-A820-00930(18.5K) or higher and the FR-A840-01800(55K) or higher, XLPE cable with a continuous maximum permissible temperature of 90°C. It is assumed that the cables will be used in a surrounding air temperatures of 40°C or less and housed in an enclosure.

(Selection example mainly for use in Europe.)

\*4 Screws for terminals R/L1, S/L2, T/L3, U, V, W, PR, PX, P/+, N/-, and P1, and the screw for earthing (grounding).

The size of screws for terminals PR and PX on FR-A820-00340(5.5K) and FR-A820-00490(7.5K) is indicated in parentheses.

The size of the earthing (grounding) screw on FR-A820-00930(18.5K) or higher and FR-A840-04320(160K) or higher is indicated in parentheses.

The size of the screw for terminal P/+ for option connection on FR-A840-03250(110K) and FR-A840-03610(132K) is indicated in parentheses.

## ◆ For the LD rating

- 200 V class (220 V input power supply, without a power factor improving AC or DC reactor)

Applicable inverter model FR-A820-[]	Terminal screw size <sup>*4</sup>	Tightening torque (N·m)	Crimp terminal		Cable gauge								
					HIV cables, etc. (mm <sup>2</sup> ) <sup>*1</sup>				AWG/MCM <sup>*2</sup>		PVC cables, etc. (mm <sup>2</sup> ) <sup>*3</sup>		
			R/L1, S/L2, T/L3	U, V, W	R/L1, S/L2, T/L3	U, V, W	P/+, P1	Earthing (grounding) cable	R/L1, S/L2, T/L3	U, V, W	R/L1, S/L2, T/L3	U, V, W	Earthing (grounding) cable
00046(0.4K)	M4	1.5	2-4	2-4	2	2	2	2	14	14	2.5	2.5	2.5
00077(0.75K)	M4	1.5	2-4	2-4	2	2	2	2	14	14	2.5	2.5	2.5
00105(1.5K)	M4	1.5	2-4	2-4	2	2	2	2	14	14	2.5	2.5	2.5
00167(2.2K)	M4	1.5	5.5-4	5.5-4	3.5	3.5	3.5	3.5	12	12	4	4	4
00250(3.7K)	M4	1.5	5.5-4	5.5-4	5.5	5.5	5.5	5.5	10	10	6	6	6

Applicable inverter model FR-A820-□	Terminal screw size <sup>*4</sup>	Tightening torque (N·m)	Crimp terminal		Cable gauge									
					HIV cables, etc. (mm <sup>2</sup> ) <sup>*1</sup>				AWG/MCM <sup>*2</sup>		PVC cables, etc. (mm <sup>2</sup> ) <sup>*3</sup>			
			R/L1, S/L2, T/L3	U, V, W	R/L1, S/L2, T/L3	U, V, W	P/+, P1	Earthing (grounding) cable	R/L1, S/L2, T/L3	U, V, W	R/L1, S/L2, T/L3	U, V, W	Earthing (grounding) cable	
00340(5.5K)	M5 (M4)	2.5	8-5	5.5-5	14	5.5	14	5.5	6	10	16	6	16	
00490(7.5K)	M5 (M4)	2.5	14-5	14-5	14	14	14	8	6	6	16	16	16	
00630(11K)	M5	2.5	22-5	22-5	22	22	22	14	4	4	25	25	16	
00770(15K)	M6	4.4	38-6	22-6	38	22	38	14	2	4	35	25	25	
00930(18.5K)	M8 (M6)	7.8	38-8	38-8	38	38	38	22	2	2	35	35	25	
01250(22K)	M8 (M6)	7.8	60-8	60-8	60	60	60	22	1/0	1/0	50	50	25	
01540(30K)	M8 (M6)	7.8	80-8	60-8	80	60	80	22	3/0	1/0	70	70	35	
01870(37K)	M10 (M8)	26.5	100-10	100-10	100	100	100	38	4/0	4/0	95	95	50	
02330(45K)	M10 (M8)	26.5	100-10	100-10	100	100	100	38	4/0	4/0	95	95	50	

- 200 V class (220 V input power supply, with a power factor improving AC or DC reactor)

Applicable inverter model FR-A820-□	Terminal screw size <sup>*4</sup>	Tightening torque (N·m)	Crimp terminal		Cable gauge									
					HIV cables, etc. (mm <sup>2</sup> ) <sup>*1</sup>				AWG/MCM <sup>*2</sup>		PVC cables, etc. (mm <sup>2</sup> ) <sup>*3</sup>			
			R/L1, S/L2, T/L3	U, V, W	R/L1, S/L2, T/L3	U, V, W	P/+, P1	Earthing (grounding) cable	R/L1, S/L2, T/L3	U, V, W	R/L1, S/L2, T/L3	U, V, W	Earthing (grounding) cable	
00046(0.4K)	M4	1.5	2-4	2-4	2	2	2	2	14	14	2.5	2.5	2.5	
00077(0.75K)	M4	1.5	2-4	2-4	2	2	2	2	14	14	2.5	2.5	2.5	
00105(1.5K)	M4	1.5	2-4	2-4	2	2	2	2	14	14	2.5	2.5	2.5	
00167(2.2K)	M4	1.5	5.5-4	5.5-4	3.5	3.5	3.5	3.5	12	12	4	4	4	
00250(3.7K)	M4	1.5	5.5-4	5.5-4	5.5	5.5	5.5	5.5	10	10	6	6	6	
00340(5.5K)	M5 (M4)	2.5	5.5-5	5.5-5	5.5	5.5	14	5.5	10	10	6	6	6	
00490(7.5K)	M5 (M4)	2.5	14-5	14-5	14	14	14	8	6	6	16	16	16	
00630(11K)	M5	2.5	22-5	22-5	22	22	22	14	4	4	25	25	16	
00770(15K)	M6	4.4	22-6	22-6	22	22	38	14	4	4	25	25	16	
00930(18.5K)	M8 (M6)	7.8	38-8	38-8	38	38	38	22	2	2	35	35	25	
01250(22K)	M8 (M6)	7.8	60-8	60-8	60	60	60	22	1/0	1/0	50	50	25	
01540(30K)	M8 (M6)	7.8	60-8	60-8	60	60	80	22	1/0	1/0	70	70	35	
01870(37K)	M10 (M8)	26.5	100-10	100-10	100	100	100	38	4/0	4/0	95	95	50	
02330(45K)	M10 (M8)	26.5	100-10	100-10	100	100	100	38	4/0	4/0	95	95	50	
03160(55K)	M12 (M8)	46	150-12	150-12	125	125	125	38	250	250	120	120	—	
03800(75K)	M12 (M8)	46	150-12	150-12	150	150	150	38	2×4/0	2×4/0	150	150	—	
04750(90K)	M12 (M8)	46	150-12	150-12	150	150	2×100	60	2×4/0	2×4/0	2×95	2×95	—	

- 400 V class (440 V input power supply, without a power factor improving AC or DC reactor)

Applicable inverter model FR-A840-□	Terminal screw size <sup>*4</sup>	Tightening torque (N·m)	Crimp terminal		Cable gauge									
					HIV cables, etc. (mm <sup>2</sup> ) <sup>*1</sup>				AWG/MCM <sup>*2</sup>		PVC cables, etc. (mm <sup>2</sup> ) <sup>*3</sup>			
			R/L1, S/L2, T/L3	U, V, W	R/L1, S/L2, T/L3	U, V, W	P/+, P1	Earthing (grounding) cable	R/L1, S/L2, T/L3	U, V, W	R/L1, S/L2, T/L3	U, V, W	Earthing (grounding) cable	
00023(0.4K)	M4	1.5	2-4	2-4	2	2	2	2	14	14	2.5	2.5	2.5	
00038(0.75K)	M4	1.5	2-4	2-4	2	2	2	2	14	14	2.5	2.5	2.5	
00052(1.5K)	M4	1.5	2-4	2-4	2	2	2	2	14	14	2.5	2.5	2.5	
00083(2.2K)	M4	1.5	2-4	2-4	2	2	2	2	14	14	2.5	2.5	2.5	
00126(3.7K)	M4	1.5	2-4	2-4	2	2	3.5	3.5	12	14	2.5	2.5	4	
00170(5.5K)	M4	1.5	5.5-4	5.5-4	3.5	3.5	3.5	3.5	12	12	4	4	4	
00250(7.5K)	M4	1.5	5.5-4	5.5-4	5.5	5.5	5.5	5.5	10	10	6	6	10	
00310(11K)	M5	2.5	8-5	5.5-5	8	5.5	8	5.5	8	10	10	6	10	
00380(15K)	M5	2.5	14-5	8-5	14	8	14	8	6	8	16	10	16	
00470(18.5K)	M6	4.4	14-6	14-6	14	14	22	14	6	6	16	16	16	
00620(22K)	M6	4.4	22-6	22-6	22	22	22	14	4	4	25	25	16	
00770(30K)	M6	4.4	22-6	22-6	22	22	22	14	4	4	25	25	16	
00930(37K)	M8	7.8	38-8	38-8	38	38	38	22	1	2	50	50	25	
01160(45K)	M8	7.8	60-8	60-8	60	60	60	22	1/0	1/0	50	50	25	

- 400 V class (440 V input power supply, with a power factor improving AC or DC reactor)

Applicable inverter model FR-A840-□	Terminal screw size <sup>*4</sup>	Tightening torque (N·m)	Crimp terminal		Cable gauge								
					HIV cables, etc. (mm <sup>2</sup> ) <sup>*1</sup>				AWG/MCM <sup>*2</sup>		PVC cables, etc. (mm <sup>2</sup> ) <sup>*3</sup>		
			R/L1, S/L2, T/L3	U, V, W	R/L1, S/L2, T/L3	U, V, W	P/+, P1	Earthing (grounding) cable	R/L1, S/L2, T/L3	U, V, W	R/L1, S/L2, T/L3	U, V, W	Earthing (grounding) cable
00023(0.4K)	M4	1.5	2-4	2-4	2	2	2	2	14	14	2.5	2.5	2.5
00038(0.75K)	M4	1.5	2-4	2-4	2	2	2	2	14	14	2.5	2.5	2.5
00052(1.5K)	M4	1.5	2-4	2-4	2	2	2	2	14	14	2.5	2.5	2.5
00083(2.2K)	M4	1.5	2-4	2-4	2	2	2	2	14	14	2.5	2.5	2.5
00126(3.7K)	M4	1.5	2-4	2-4	2	2	3.5	3.5	14	14	2.5	2.5	2.5
00170(5.5K)	M4	1.5	5.5-4	5.5-4	3.5	3.5	3.5	3.5	12	12	4	4	4
00250(7.5K)	M4	1.5	5.5-4	5.5-4	5.5	5.5	5.5	5.5	10	10	6	6	6
00310(11K)	M5	2.5	5.5-5	5.5-5	5.5	5.5	8	5.5	10	10	6	6	6
00380(15K)	M5	2.5	8-5	8-5	8	8	14	8	8	8	10	10	10
00470(18.5K)	M6	4.4	14-6	14-6	14	14	22	14	6	6	16	16	16
00620(22K)	M6	4.4	22-6	22-6	22	22	22	14	4	4	25	25	16
00770(30K)	M6	4.4	22-6	22-6	22	22	22	14	4	4	25	25	16
00930(37K)	M8	7.8	38-8	38-8	38	38	38	22	2	2	50	50	25
01160(45K)	M8	7.8	60-8	60-8	60	60	60	22	1/0	1/0	50	50	25
01800(55K)	M8	7.8	60-8	60-8	60	60	60	22	1/0	1/0	50	50	25
02160(75K)	M10	26.5	60-10	60-10	60	60	80	22	1/0	1/0	50	50	25
02600(90K)	M10	26.5	80-10	80-10	80	80	80	22	3/0	3/0	70	70	35
03250(110K)	M10 (M12)	26.5	100-10	100-10	100	100	100	38	4/0	4/0	95	95	50
03610(132K)	M10 (M12)	26.5	150-10	150-10	125	125	150	38	250	250	120	120	70
04320(160K)	M12 (M10)	46	150-12	150-12	150	150	150	38	300	300	150	150	95
04810(185K)	M12 (M10)	46	100-12	100-12	2×100	2×100	2×100	60	2×4/0	2×4/0	2×95	2×95	95
05470(220K)	M12 (M10)	46	100-12	100-12	2×100	2×100	2×125	60	2×4/0	2×4/0	2×95	2×95	95
06100(250K)	M12 (M10)	46	150-12	150-12	2×125	2×125	2×125	60	2×250	2×250	2×120	2×120	120
06830(280K)	M12 (M10)	46	150-12	150-12	2×150	2×150	2×150	60	2×300	2×300	2×150	2×150	150

\*1 For the FR-A820-03160(55K) or lower and FR-A840-01800(55K) or lower, HIV cable (600 V grade heat-resistant PVC insulated wire) etc. with a continuous maximum permissible temperature of 75°C. It assumes that the cables will be used in a surrounding air temperature of 50°C or less and the wiring distance is 20 m or shorter.

For the FR-A820-03800(75K) or higher, FR-A840-02160(75K) or higher, LMFC (heat resistant flexible cross-linked polyethylene insulated cable) etc. with a continuous maximum permissible temperature of 90°C or more. It is assumed that the cables will be used in a surrounding air temperatures of 50°C or less and housed in an enclosure.

\*2 For all the 200 V class capacities and FR-A840-01160(45K) or lower, THHW cable with a continuous maximum permissible temperature of 75°C. It assumes that the cables will be used in a surrounding air temperature of 40°C or less and the wiring distance is 20 m or shorter.

For the FR-A840-01800(55K) or higher, THHN cable with a continuous maximum permissible temperature of 90°C. It is assumed that the cables will be used in a surrounding air temperatures of 40°C or less and housed in an enclosure.

(For the use in the United States or Canada, refer to "Instructions for UL and cUL" in the Instruction Manual (Startup) or Instruction Manual (Hardware).)

\*3 For the FR-A820-00770(15K) or lower and the FR-A840-01160(45K) or lower, PVC cable with a continuous maximum permissible temperature of 70°C. It assumes that the cables will be used in a surrounding air temperature of 40°C or less and the wiring distance is 20 m or shorter.

For the FR-A820-00930(18.5K) or higher and the FR-A840-01800(55K) or higher, XLPE cable with a continuous maximum permissible temperature of 90°C. It is assumed that the cables will be used in a surrounding air temperatures of 40°C or less and housed in an enclosure.

(Selection example mainly for use in Europe.)

\*4 Screws for terminals R/L1, S/L2, T/L3, U, V, W, PR, PX, P/+, N/-, and P1, and the screw for earthing (grounding).

The size of screws for terminals PR and PX on FR-A820-00340(5.5K) and FR-A820-00490(7.5K) is indicated in parentheses.

The size of the earthing (grounding) screw on FR-A820-00930(18.5K) or higher and FR-A840-04320(160K) or higher is indicated in parentheses.

The size of the screw for terminal P/+ for option connection on FR-A840-03250(110K) and FR-A840-03610(132K) is indicated in parentheses.

## ◆ For the HD rating

- 200 V class (220 V input power supply, without a power factor improving AC or DC reactor)

Applicable inverter model FR-A820-□	Terminal screw size <sup>*4</sup>	Tightening torque (N·m)	Crimp terminal		Cable gauge								
					HIV cables, etc. (mm <sup>2</sup> ) <sup>*1</sup>				AWG/MCM <sup>*2</sup>		PVC cables, etc. (mm <sup>2</sup> ) <sup>*3</sup>		
			R/L1, S/L2, T/L3	U, V, W	R/L1, S/L2, T/L3	U, V, W	P/+, P1	Earthing (grounding) cable	R/L1, S/L2, T/L3	U, V, W	R/L1, S/L2, T/L3	U, V, W	Earthing (grounding) cable
00046(0.4K)	M4	1.5	2-4	2-4	2	2	2	2	14	14	2.5	2.5	2.5
00077(0.75K)	M4	1.5	2-4	2-4	2	2	2	2	14	14	2.5	2.5	2.5
00105(1.5K)	M4	1.5	2-4	2-4	2	2	2	2	14	14	2.5	2.5	2.5
00167(2.2K)	M4	1.5	2-4	2-4	2	2	2	2	14	14	2.5	2.5	2.5
00250(3.7K)	M4	1.5	2-4	2-4	2	2	2	2	14	14	2.5	2.5	2.5

Applicable inverter model FR-A820-[]	Terminal screw size <sup>*4</sup>	Tightening torque (N·m)	Crimp terminal		Cable gauge									
					HIV cables, etc. (mm <sup>2</sup> ) <sup>*1</sup>				AWG/MCM <sup>*2</sup>		PVC cables, etc. (mm <sup>2</sup> ) <sup>*3</sup>			
			R/L1, S/L2, T/L3	U, V, W	R/L1, S/L2, T/L3	U, V, W	P/+, P1	Earthing (grounding) cable	R/L1, S/L2, T/L3	U, V, W	R/L1, S/L2, T/L3	U, V, W	Earthing (grounding) cable	
00340(5.5K)	M5 (M4)	2.5	5.5-4	5.5-4	3.5	3.5	3.5	3.5	12	12	4	4	4	
00490(7.5K)	M5 (M4)	2.5	5.5-5	5.5-5	5.5	5.5	5.5	5.5	10	10	6	6	6	
00630(11K)	M5	2.5	14-5	8-5	14	8	14	5.5	6	8	16	10	16	
00770(15K)	M6	4.4	14-6	14-6	14	14	14	8	6	6	16	16	16	
00930(18.5K)	M8 (M6)	7.8	22-8	22-8	22	22	22	14	4	4	25	25	16	
01250(22K)	M8 (M6)	7.8	38-8	22-8	38	22	38	14	2	4	35	25	25	
01540(30K)	M8 (M6)	7.8	38-8	38-8	38	38	38	22	2	2	35	35	25	
01870(37K)	M10 (M8)	26.5	60-10	60-10	60	60	60	22	1/0	1/0	50	50	25	
02330(45K)	M10 (M8)	26.5	80-10	60-10	80	60	80	22	3/0	1/0	70	70	35	
03160(55K)	M12 (M8)	46	100-12	100-12	100	100	100	38	4/0	4/0	95	95	50	

- 200 V class (220 V input power supply, with a power factor improving AC or DC reactor)

Applicable inverter model FR-A820-[]	Terminal screw size <sup>*4</sup>	Tightening torque (N·m)	Crimp terminal		Cable gauge									
					HIV cables, etc. (mm <sup>2</sup> ) <sup>*1</sup>				AWG/MCM <sup>*2</sup>		PVC cables, etc. (mm <sup>2</sup> ) <sup>*3</sup>			
			R/L1, S/L2, T/L3	U, V, W	R/L1, S/L2, T/L3	U, V, W	P/+, P1	Earthing (grounding) cable	R/L1, S/L2, T/L3	U, V, W	R/L1, S/L2, T/L3	U, V, W	Earthing (grounding) cable	
00046(0.4K)	M4	1.5	2-4	2-4	2	2	2	2	14	14	2.5	2.5	2.5	
00077(0.75K)	M4	1.5	2-4	2-4	2	2	2	2	14	14	2.5	2.5	2.5	
00105(1.5K)	M4	1.5	2-4	2-4	2	2	2	2	14	14	2.5	2.5	2.5	
00167(2.2K)	M4	1.5	2-4	2-4	2	2	2	2	14	14	2.5	2.5	2.5	
00250(3.7K)	M4	1.5	2-4	2-4	2	2	2	2	14	14	2.5	2.5	2.5	
00340(5.5K)	M5 (M4)	2.5	5.5-5	5.5-5	3.5	3.5	3.5	3.5	12	12	4	4	4	
00490(7.5K)	M5 (M4)	2.5	5.5-5	5.5-5	5.5	5.5	5.5	5.5	10	10	6	6	6	
00630(11K)	M5	2.5	14-5	8-5	14	8	14	5.5	8	8	10	10	10	
00770(15K)	M6	4.4	14-6	14-6	14	14	14	8	6	6	16	16	16	
00930(18.5K)	M8 (M6)	7.8	22-8	22-8	22	22	22	14	4	4	25	25	16	
01250(22K)	M8 (M6)	7.8	22-8	22-8	22	22	38	14	4	4	25	25	16	
01540(30K)	M8 (M6)	7.8	38-8	38-8	38	38	38	22	2	2	35	35	25	
01870(37K)	M10 (M8)	26.5	60-10	60-10	60	60	60	22	1/0	1/0	50	50	25	
02330(45K)	M10 (M8)	26.5	60-10	60-10	60	60	80	22	1/0	1/0	70	70	35	
03160(55K)	M12 (M8)	46	100-12	100-12	100	100	100	38	4/0	4/0	95	95	50	
03800(75K)	M12 (M8)	46	100-12	100-12	100	100	100	38	4/0	4/0	95	95	50	
04750(90K)	M12 (M8)	46	150-12	150-12	125	125	125	38	250	250	120	120	—	

- 400 V class (440 V input power supply, without a power factor improving AC or DC reactor)

Applicable inverter model FR-A840-[]	Terminal screw size <sup>*4</sup>	Tightening torque (N·m)	Crimp terminal		Cable gauge									
					HIV cables, etc. (mm <sup>2</sup> ) <sup>*1</sup>				AWG/MCM <sup>*2</sup>		PVC cables, etc. (mm <sup>2</sup> ) <sup>*3</sup>			
			R/L1, S/L2, T/L3	U, V, W	R/L1, S/L2, T/L3	U, V, W	P/+, P1	Earthing (grounding) cable	R/L1, S/L2, T/L3	U, V, W	R/L1, S/L2, T/L3	U, V, W	Earthing (grounding) cable	
00023(0.4K)	M4	1.5	2-4	2-4	2	2	2	2	14	14	2.5	2.5	2.5	
00038(0.75K)	M4	1.5	2-4	2-4	2	2	2	2	14	14	2.5	2.5	2.5	
00052(1.5K)	M4	1.5	2-4	2-4	2	2	2	2	14	14	2.5	2.5	2.5	
00083(2.2K)	M4	1.5	2-4	2-4	2	2	2	2	14	14	2.5	2.5	2.5	
00126(3.7K)	M4	1.5	2-4	2-4	2	2	2	2	14	14	2.5	2.5	2.5	
00170(5.5K)	M4	1.5	2-4	2-4	2	2	2	2	14	14	2.5	2.5	2.5	
00250(7.5K)	M4	1.5	2-4	2-4	2	2	3.5	3.5	12	14	2.5	2.5	2.5	
00310(11K)	M5	2.5	5.5-5	5.5-5	3.5	3.5	3.5	3.5	12	12	4	4	4	
00380(15K)	M5	2.5	5.5-5	5.5-5	5.5	5.5	5.5	5.5	10	10	6	6	6	
00470(18.5K)	M6	4.4	8-6	5.5-6	8	5.5	8	5.5	8	10	10	6	10	
00620(22K)	M6	4.4	14-6	8-6	14	8	14	8	6	8	16	10	16	
00770(30K)	M6	4.4	14-6	14-6	14	14	22	14	6	6	16	16	16	
00930(37K)	M8	7.8	22-8	22-8	22	22	22	14	4	4	25	25	16	
01160(45K)	M8	7.8	22-8	22-8	22	22	22	14	4	4	25	25	16	
01800(55K)	M8	7.8	38-8	38-8	38	38	38	22	1	2	50	50	25	

- 400 V class (440 V input power supply, with a power factor improving AC or DC reactor)

Applicable inverter model FR-A840-□	Terminal screw size <sup>4</sup>	Tightening torque (N·m)	Crimp terminal		Cable gauge								
					HIV cables, etc. (mm <sup>2</sup> ) <sup>*1</sup>				AWG/MCM <sup>*2</sup>		PVC cables, etc. (mm <sup>2</sup> ) <sup>*3</sup>		
			R/L1, S/L2, T/L3	U, V, W	R/L1, S/L2, T/L3	U, V, W	P/+, P1	Earthing (grounding) cable	R/L1, S/L2, T/L3	U, V, W	R/L1, S/L2, T/L3	U, V, W	Earthing (grounding) cable
00023(0.4K)	M4	1.5	2-4	2-4	2	2	2	2	14	14	2.5	2.5	2.5
00038(0.75K)	M4	1.5	2-4	2-4	2	2	2	2	14	14	2.5	2.5	2.5
00052(1.5K)	M4	1.5	2-4	2-4	2	2	2	2	14	14	2.5	2.5	2.5
00083(2.2K)	M4	1.5	2-4	2-4	2	2	2	2	14	14	2.5	2.5	2.5
00126(3.7K)	M4	1.5	2-4	2-4	2	2	2	2	14	14	2.5	2.5	2.5
00170(5.5K)	M4	1.5	2-4	2-4	2	2	2	2	14	14	2.5	2.5	2.5
00250(7.5K)	M4	1.5	2-4	2-4	2	2	3.5	3.5	12	14	2.5	2.5	2.5
00310(11K)	M5	2.5	5.5-6	5.5-6	3.5	3.5	3.5	3.5	12	12	4	4	4
00380(15K)	M5	2.5	5.5-5	5.5-5	5.5	5.5	5.5	5.5	10	10	6	6	6
00470(18.5K)	M6	4.4	5.5-6	5.5-6	5.5	5.5	8	5.5	10	10	6	6	6
00620(22K)	M6	4.4	8-6	8-6	8	8	14	8	8	8	10	10	10
00770(30K)	M6	4.4	14-6	14-6	14	14	22	14	6	6	16	16	16
00930(37K)	M8	7.8	22-8	22-8	22	22	22	14	4	4	25	25	16
01160(45K)	M8	7.8	22-8	22-8	22	22	22	14	4	4	25	25	16
01800(55K)	M8	7.8	38-8	38-8	38	38	38	22	2	2	50	50	25
02160(75K)	M10	26.5	60-10	60-10	60	60	60	22	1/0	1/0	50	50	25
02600(90K)	M10	26.5	60-10	60-10	60	60	60	22	1/0	1/0	50	50	25
03250(110K)	M10 (M12)	26.5	60-10	60-10	60	60	80	22	3/0	3/0	50	50	25
03610(132K)	M10 (M12)	26.5	80-10	80-10	80	80	80	22	3/0	3/0	70	70	35
04320(160K)	M12 (M10)	46	100-12	100-12	100	100	100	38	4/0	4/0	95	95	50
04810(185K)	M12 (M10)	46	150-12	150-12	125	125	150	38	250	250	120	120	70
05470(220K)	M12 (M10)	46	150-12	150-12	150	150	150	38	300	300	150	150	95
06100(250K)	M12 (M10)	46	100-12	100-12	2×100	2×100	2×100	60	2×4/0	2×4/0	2×95	2×95	95
06830(280K)	M12 (M10)	46	100-12	100-12	2×100	2×100	2×125	60	2×4/0	2×4/0	2×95	2×95	95

\*1 For the FR-A820-03160(55K) or lower and FR-A840-01800(55K) or lower, HIV cable (600 V grade heat-resistant PVC insulated wire) etc. with a continuous maximum permissible temperature of 75°C. It assumes that the cables will be used in a surrounding air temperature of 50°C or less and the wiring distance is 20 m or shorter.

For the FR-A820-03800(75K) or higher, FR-A840-02160(75K) or higher, LMFC (heat resistant flexible cross-linked polyethylene insulated cable) etc. with a continuous maximum permissible temperature of 90°C or more. It is assumed that the cables will be used in a surrounding air temperatures of 50°C or less and housed in an enclosure.

\*2 For all the 200 V class capacities and FR-A840-01160(45K) or lower, THHW cable with a continuous maximum permissible temperature of 75°C. It assumes that the cables will be used in a surrounding air temperature of 40°C or less and the wiring distance is 20 m or shorter.

For the FR-A840-01800(55K) or higher, THHN cable with a continuous maximum permissible temperature of 90°C. It is assumed that the cables will be used in a surrounding air temperatures of 40°C or less and housed in an enclosure.

(For the use in the United States or Canada, refer to "Instructions for UL and cUL" in the Instruction Manual (Startup) or Instruction Manual (Hardware).)

\*3 For the FR-A820-00770(15K) or lower and the FR-A840-01160(45K) or lower, PVC cable with a continuous maximum permissible temperature of 70°C. It assumes that the cables will be used in a surrounding air temperature of 40°C or less and the wiring distance is 20 m or shorter.

For the FR-A820-00930(18.5K) or higher and the FR-A840-01800(55K) or higher, XLPE cable with a continuous maximum permissible temperature of 90°C. It is assumed that the cables will be used in a surrounding air temperatures of 40°C or less and housed in an enclosure.

(Selection example mainly for use in Europe.)

\*4 Screws for terminals R/L1, S/L2, T/L3, U, V, W, PR, PX, P/+, N/-, and P1, and the screw for earthing (grounding).

The size of screws for terminals PR and PX on FR-A820-00340(5.5K) and FR-A820-00490(7.5K) is indicated in parentheses.

The size of the earthing (grounding) screw on FR-A820-00930(18.5K) or higher and FR-A840-04320(160K) or higher is indicated in parentheses.

The size of the screw for terminal P/+ for option connection on FR-A840-03250(110K) and FR-A840-03610(132K) is indicated in parentheses.

The line voltage drop can be calculated by the following formula:

$$\text{Line voltage drop [V]} = \frac{\sqrt{3} \times \text{wire resistance [m}\Omega\text{/m]} \times \text{wiring distance [m]} \times \text{current [A]}}{1000}$$

Use a larger diameter cable when the wiring distance is long or when the voltage drop (torque reduction) in the low speed range needs to be reduced.



## NOTE

- Tighten the terminal screw to the specified torque.  
A screw that has been tightened too loosely can cause a short circuit or malfunction.  
A screw that has been tightened too tightly can cause a short circuit or malfunction due to the unit breakage.
- Use crimp terminals with insulation sleeves to wire the power supply and motor.

## ◆ Total wiring length

### ■ With induction motor

Connect one or more general-purpose motors within the total wiring length shown in the following table. (The wiring length should be 100 m or shorter under Vector control.)

Pr.72 setting (carrier frequency)	FR-A820-00046(0.4K) FR-A840-00023(0.4K)	FR-A820-00077(0.75K) FR-A840-00038(0.75K)	FR-A820-00105(1.5K) or higher FR-A840-00052(1.5K) or higher
2 (2 kHz) or lower	300 m	500 m	500 m
3 (3 kHz) or higher	200 m	300 m	500 m

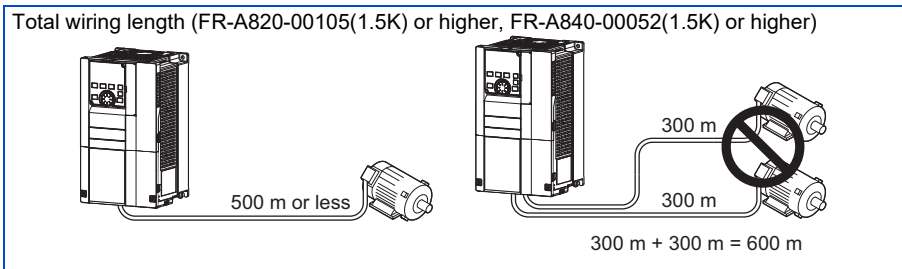

When driving a 400 V class motor by the inverter, surge voltages attributable to the wiring constants may occur at the motor terminals, deteriorating the insulation of the motor. In this case, take one of the following measure.

- Use a "400 V class inverter-driven insulation-enhanced motor" and set **Pr.72 PWM frequency selection** according to the wiring length.

Wiring length 50 m or shorter	Wiring length 50 to 100 m	Wiring length longer than 100 m
15 (14.5 kHz) or lower	9 (9 kHz) or lower	4 (4 kHz) or lower

- For the FR-A840-01800(55K) or lower, connect a surge voltage suppression filter (FR-ASF-H/FR-BMF-H) at the output side of the inverter. For the FR-A840-02160(75K) or higher, connect a sine wave filter (MT-BSL/BSC) at the output side of the inverter.

### ■ With PM motor

Use the wiring length of 100 m or shorter when connecting a PM motor.

Use one PM motor for one inverter. Multiple PM motors cannot be connected to an inverter.

When the wiring length exceeds 50 m for a 400 V class motor driven by an inverter under PM sensorless vector control, set "9" (6 kHz) or less in **Pr.72 PWM frequency selection**.

## NOTE

- Especially for long-distance wiring, the inverter may be affected by a charging current caused by stray capacitance of the wiring, leading to an activation of the overcurrent protection, malfunction of the fast-response current limit operation, or even to an inverter failure. It may also cause a malfunction or fault of the equipment connected ON the inverter output side. If the fast-response current limit function malfunctions, disable the function. (Refer to **Pr.156 Stall prevention operation selection** on [page 431](#).)
- A surge voltage suppression filter (FR-ASF-H/FR-BMF-H) can be used under V/F control and Advanced magnetic flux vector control.  
A sine wave filter (MT-BSL/BSC) can be used under V/F control. Do not use the filters under different control methods.
- For details on **Pr.72 PWM frequency selection**, refer to [page 356](#).
- Refer to [page 130](#) to drive a 400 V class motor by an inverter.
- The carrier frequency is limited during PM sensorless vector control. (Refer to [page 356](#).)

## 2.5.4 Earthing (grounding) precautions

Always earth (ground) the motor and inverter.

### ◆ Purpose of earthing (grounding)

Generally, an electrical apparatus has an earth (ground) terminal, which must be connected to the ground before use.

An electrical circuit is usually insulated by an insulating material and encased. However, it is impossible to manufacture an insulating material that can shut off a leakage current completely, and actually, a slight current flows into the case. The purpose of earthing (grounding) the case of an electrical apparatus is to prevent operators from getting an electric shock from this leakage current when touching it.

To avoid the influence of external noises, the earthing (grounding) is important to EMI-sensitive equipment that handle low-level signals or operate very fast such as audio equipment, sensors, computers.

### ◆ Earthing (grounding) system to be established

As described previously, the purpose of earthing (grounding) is roughly classified into the electrical shock prevention and the prevention of malfunction due to the influence of electromagnetic noise. These two purposes should be clearly distinguished, and the appropriate earth (ground) system must be established to prevent the leakage current having the inverter's high frequency components from reversing through another earth (ground) point for malfunction prevention by following these instructions:

- Make the separate earth (ground) connection (I) for high frequency products such as the inverter from any other devices (EMI-sensitive devices described above) wherever possible.

Establishing adequate common (single-point) earth (ground) system (II) shown in the following figure is allowed only in cases where the separate earth (ground) system (I) is not feasible. Do not make inadequate common (single-point) earth (ground) connection (III).

As leakage currents containing many high frequency components flows into the earthing (grounding) cables of the inverter and peripheral devices (including a motor), the inverter must also be earthed (grounded) separately from EMI-sensitive devices described above.

In a high building, it may be effective to use its iron structure frames as earthing (grounding) electrode for EMI prevention in order to separate from the earth (ground) system for electric shock prevention.

- Earthing (Grounding) must conform to the requirements of national and local safety regulations and electrical codes (NEC section 250, IEC 61140 class 1 and other applicable standards). A neutral-point earthed (grounded) power supply for 400 V class inverter in compliance with EN standard must be used.
- Use the thickest possible earthing (grounding) cable. The earthing (grounding) cable should be equal to the size indicated in the table on [page 57](#).
- The earthing (grounding) point should be as close as possible to the inverter, and the earth (ground) wire length should be as short as possible.
- Run the earthing (grounding) cable as far away as possible from the I/O wiring of the EMI-sensitive devices and run them in parallel in the minimum distance.

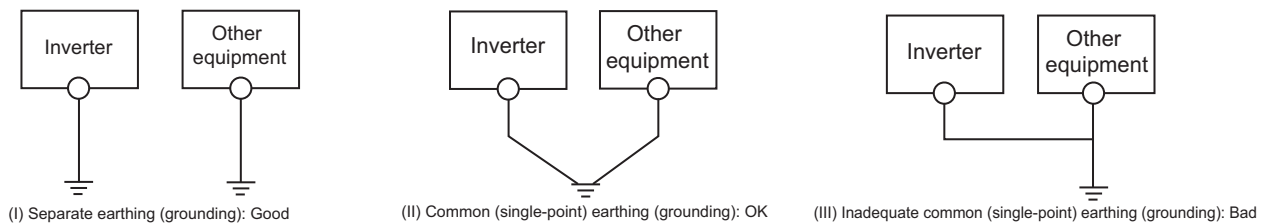

#### NOTE

- To be compliant with the EU Directive (Low Voltage Directive), refer to the Instruction Manual (Startup).



## 2.6 Control circuit

### 2.6.1 Details on the control circuit terminals

#### ◆ Input signal

Type	Terminal symbol	Common	Terminal name	Terminal function description		Rated specification	Refer to page
Contact input	STF <sup>*1</sup>	SD (sink (negative common)) PC (source (positive common))	Forward rotation start	Turn ON the STF signal to start forward rotation and turn it OFF to stop.	When the STF and STR signals are turned ON simultaneously, the stop command is given.	Input resistance: 4.7 kΩ, voltage when contacts are open: 21 to 27 VDC, current when contacts are short-circuited: 4 to 6 mADC	722
	STR <sup>*1</sup>		Reverse rotation start	Turn ON the STR signal to start reverse rotation and turn it OFF to stop.			
	STP (STOP) <sup>*1</sup>		Start self-holding selection	Turn ON the STP (STOP) signal to self-hold the start signal.	Input resistance: 2 kΩ, current when contacts are short-circuited: 8 to 13 mADC		722
	RH RM RL <sup>*1</sup>		Multi-speed selection	Multi-speed can be selected according to the combination of RH, RM and RL signals.			411
	JOG <sup>*1</sup>		Jog mode selection	Turn ON the JOG signal to enable JOG operation (initial setting) and turn ON the start (STF or STR) signal to start JOG operation.		410	
			Pulse train input	Terminal JOG is also used as a pulse train input terminal. To use as a pulse train input terminal, change the <b>Pr.291</b> setting. (maximum input pulse: 100k pulses/s)	406		
	RT <sup>*1</sup>		Second function selection	Turn ON the RT signal to enable the second function. When the second function such as "Second torque boost" and "Second V/F (base frequency)" is set, turning ON the RT signal enables the selected function.	Input resistance: 4.7 kΩ, voltage when contacts are open: 21 to 27 VDC, current when contacts are short-circuited: 4 to 6 mADC	525	
	MRS <sup>*1</sup>		Output stop	Turn ON the MRS signal (20 ms or more) to stop the inverter output. Use this signal to shut off the inverter output when stopping the motor with an electromagnetic brake.		524	
	RES <sup>*1</sup>		Reset	Use this signal to reset a fault output provided when a protective function is activated. Turn ON the RES signal for 0.1 second or longer, then turn it OFF. In the initial setting, reset is always enabled. By setting <b>Pr.75</b> , reset can be enabled only at an inverter fault occurrence. The inverter recovers about 1 second after the reset is released.	336		
	AU <sup>*1</sup>		Terminal 4 input selection	The terminal 4 function is available only when the AU signal is ON. Turning the AU signal ON makes terminal 2 invalid.	496		
CS <sup>*1</sup>	Selection of automatic restart after instantaneous power failure	When the CS signal is left ON, the inverter restarts automatically at power restoration. Note that restart setting is necessary for this operation. In the initial setting, a restart is disabled.	628, 635				

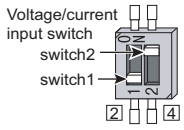
Type	Terminal symbol	Common	Terminal name	Terminal function description	Rated specification	Refer to page
Frequency setting	10E	5	Frequency setting power supply	When connecting the frequency setting potentiometer at an initial status, connect it to terminal 10. Change the input specifications of terminal 2 using <b>Pr.73</b> when connecting it to terminal 10E.	10 VDC $\pm$ 0.4 V, permissible load current: 10 mA	496
	10	5			5 VDC $\pm$ 0.5 V, permissible load current: 10 mA	496
	2	5	Frequency setting (voltage)	Inputting 0 to 5 VDC (or 0 to 10 V, 0 to 20 mA) provides the maximum output frequency at 5 V (10 V, 20 mA) and makes input and output proportional. Use <b>Pr.73</b> to switch among input 0 to 5 VDC (initial setting), 0 to 10 VDC, and 0 to 20 mA. Set the voltage/current input switch 1 for terminal 2 in the ON position to select current input (0 to 20 mA). <sup>*2</sup>	For voltage input, input resistance: 10 to 11 k $\Omega$ , maximum permissible voltage: 20 VDC. For current input, input resistance: 245 $\pm$ 5 $\Omega$ , maximum permissible current: 30 mA.	496
	4	5	Frequency setting (current)	Inputting 4 to 20 mADC (or 0 to 5 V, 0 to 10 V) provides the maximum output frequency at 20 mA and makes input and output proportional. This input signal is valid only when the AU signal is ON (terminal 2 input is invalid). Use <b>Pr.267</b> to switch among input 4 to 20 mA (initial setting), 0 to 5 VDC, and 0 to 10 VDC. Set the voltage/current input switch 2 for terminal 4 in the OFF position to select voltage input (0 to 5 V / 0 to 10 V). <sup>*2</sup> Use <b>Pr.858</b> to switch terminal functions.		496
	1	5	Frequency setting auxiliary	Input 0 to $\pm$ 5 VDC or 0 to $\pm$ 10 VDC to add this signal to the frequency setting signal input via terminal 2 or 4. Use <b>Pr.73</b> to switch between input 0 to $\pm$ 5 VDC and 0 to $\pm$ 10 VDC (initial setting). Use <b>Pr.868</b> to switch terminal functions.	Input resistance: 10 to 11 k $\Omega$ , maximum permissible voltage: $\pm$ 20 VDC.	496
Thermistor	10 2	—	PTC thermistor input	For receiving PTC thermistor outputs. When PTC thermistor is valid ( <b>Pr.561</b> $\neq$ "9999"), terminal 2 is not available for frequency setting.	Applicable PTC thermistor specification, overheat detection resistance: 0.5 to 30 k $\Omega$ (Set by <b>Pr.561</b> )	415
Power supply input	+24	SD	24 V external power supply input	For connecting a 24 V external power supply. If a 24 V external power supply is connected, power is supplied to the control circuit while the main power circuit is OFF.	Input voltage: 23 to 25.5 VDC, input current: 1.4 A or less	80

\*1 The terminal function can be selected by **Pr.178 to Pr.196 (Input terminal function selection)**. (Refer to [page 521](#).)

\*2 Set **Pr.73**, **Pr.267**, and the voltage/current input switch correctly, then input an analog signal in accordance with the setting. Applying a voltage with the switch ON (current input is selected) or applying a current with the switch OFF (voltage input is selected) could cause component damage of the inverter or analog circuits of output devices. (For the details, refer to [page 496](#).)

\*3 Sink logic is initially set for the FM-type inverter.

\*4 Source logic is initially set for the CA-type inverter.

## ◆ Output signal

Type	Terminal symbol	Common	Terminal name	Terminal function description	Rated specification	Refer to page	
Relay	A1, B1, C1 <sup>*1</sup>	—	Relay output 1 (fault output)	1 changeover contact output that indicates that an inverter's protective function has been activated and the outputs are stopped. Fault: discontinuity across B and C (continuity across A and C), Normal: continuity across B and C (discontinuity across A and C)	Contact capacity: 230 VAC 0.3 A (power factor = 0.4), 30 VDC 0.3 A	473	
	A2, B2, C2 <sup>*1</sup>	—	Relay output 2	1 changeover contact output		473	
Open collector	RUN <sup>*1</sup>	SE	Inverter running	The output is in LOW state when the inverter output frequency is equal to or higher than the starting frequency (initial value: 0.5 Hz). The output is in HIGH state during stop or DC injection brake operation.	Fault code (4 bits) output. (Refer to page 492.)	473	
	SU <sup>*1</sup>	SE	Up to frequency	The output is in LOW state when the output frequency is within the set frequency range $\pm 10\%$ (initial value). The output is in HIGH state during acceleration/deceleration and at a stop.		484	
	OL <sup>*1</sup>	SE	Overload warning	The output is in LOW state when stall prevention is activated by the stall prevention function. The output is in HIGH state when stall prevention is canceled.		431	
	IPF <sup>*1</sup>	SE	Instantaneous power failure	The output is in LOW state when an instantaneous power failure occurs or when the undervoltage protection is activated.		628, 635	
	FU <sup>*1</sup>	SE	Frequency detection	The output is in LOW state when the inverter output frequency is equal to or higher than the preset detection frequency, and is in HIGH state when it is less than the preset detection frequency.		484	
Pulse	FM <sup>*2</sup>	SD	For meter	Among several monitor items such as output frequency, select one to output it via these terminals. The signal is not output during an inverter reset. The size of output signal is proportional to the magnitude of the corresponding monitor item. Use <b>Pr.55</b> , <b>Pr.56</b> , and <b>Pr.866</b> to set full scales for the monitoring output frequency, output current, and torque. (Refer to page 457.)	Output item: output frequency (initial setting)	Permissible load current: 2 mA, pulse for full scale: 1440 pulses/s	457
			NPN open collector output		This terminal can be used for open collector outputs depending on the <b>Pr.291</b> setting.	Maximum output pulse: 50k pulses/s, permissible load current: 80 mA	406
Analog	AM	5	Analog voltage output		Output item: output frequency (initial setting)	Output signal: 0 $\pm$ 10 VDC, permissible load current: 1 mA (load impedance 10 k $\Omega$ or more), resolution: 13 bits	457
	CA <sup>*3</sup>	5	Analog current output			Load impedance: 200 to 450 $\Omega$ , output signal: 0 to 20 mADC	457

\*1 The terminal function can be selected by **Pr.190 to Pr.196 (Output terminal function selection)**. (Refer to page 473.)

\*2 Terminal FM is provided in the FM-type inverter.

\*3 Terminal CA is provided in the CA-type inverter.

## ◆ Safety stop signal

Terminal symbol	Terminal name	Common	Terminal function description	Rated specification	Refer to page
S1	Safety stop input (channel 1)	SIC	Use terminals S1 and S2 to receive the safety stop signal input from the safety relay module. Terminals S1 and S2 can be used at a time (dual channel). The Inverter judges the condition of the internal safety circuit from the status (shorted/opened) between terminals S1 and SIC, or between S2 and SIC. When the status is opened, the inverter output is shut off. In the initial status, terminal S1 and S2 are shorted with terminal PC by shorting wires. Terminal SIC is shorted with terminal SD. Remove the shorting wires and connect the safety relay module when using the safety stop function.	Input resistance: 4.7 kΩ, input current: 4 to 6 mADC (with 24 VDC input)	82
S2	Safety stop input (channel 2)				
So (SO)	Safety monitor output (open collector output)	SOC	The output status varies depending on the input status of the safety stop signals. The output is in HIGH state during occurrence of the internal safety circuit failure. The output is in LOW state otherwise. (The open collector transistor is ON (conductive) in LOW state. The transistor is OFF (not conductive) in HIGH state.) Refer to the Safety Stop Function Instruction Manual if the output becomes in HIGH state even though both terminals S1 and S2 are open. (Contact your sales representative for this manual.)	Permissible load: 24 VDC (27 VDC at maximum), 0.1 A (The voltage drop is 3.4 V at maximum while the signal is ON.)	

## ◆ Common terminal

Terminal symbol	Common	Terminal name	Terminal function description	Rated specification	Refer to page
SD	—	Contact input common (sink) <sup>*1</sup>	Common terminal for the contact input terminal (sink logic), terminal FM.	—	—
		External transistor common (source) <sup>*2</sup>	Connect this terminal to the power supply common terminal of a transistor output (open collector output) device, such as a programmable controller, in the source logic to avoid malfunction by undesirable current.		
		24 VDC power supply common	Common terminal for the 24 VDC power supply (terminal PC, terminal +24). Isolated from terminals 5 and SE.		
PC	—	External transistor common (sink) <sup>*1</sup>	Connect this terminal to the power supply common terminal of a transistor output (open collector output) device, such as a programmable controller, in the sink logic to avoid malfunction by undesirable current.	Power supply voltage range: 19.2 to 28.8 VDC, permissible load current: 100 mA	73
		Contact input common (source) <sup>*2</sup>	Common terminal for contact input terminal (source logic).		
	SD	24 VDC power supply	Can be used as a 24 VDC 0.1 A power supply.		
5	—	Frequency setting common	Common terminal for the frequency setting signal (via terminal 2, 1, or 4) and for the analog output terminals AM and CA. Do not earth (ground).	—	496
SE	—	Open collector output common	Common terminal for terminals RUN, SU, OL, IPF, FU	—	—
SIC	—	Safety stop input terminal common	Common terminal for terminals S1 and S2.	—	82
SOC	—	Safety monitor output terminal common	Common terminal for terminal So (SO).	—	82

\*1 Sink logic is initially set for the FM-type inverter.

\*2 Source logic is initially set for the CA-type inverter.

## ◆ Communication

Type	Terminal symbol	Terminal name	Terminal function description	Refer to page	
RS-485	—	PU connector	RS-485 communication can be made through the PU connector (For connection on a 1:1 basis only) Conforming standard: EIA-485 (RS-485) Transmission format: Multidrop link Communication speed: 4800 to 115200 bps Wiring length: 500 m	659	
		RS-485 terminals	TXD+	Inverter transmission terminal	RS-485 communication can be made through the RS-485 terminals. Conforming standard: EIA-485 (RS-485) Transmission format: Multidrop link Communication speed: 300 to 115200 bps Overall length: 500 m
			TXD-		
			RXD+	Inverter reception terminal	
			RXD-		
GND (SG)	Earthing (grounding)				
USB	—	USB A connector	A connector (receptacle). Plug a USB memory device into this connector to copy parameter settings or use the trace function.	85	
		USB B connector	Mini B connector (receptacle). By connecting the inverter to a personal computer via this connector, FR Configurator2 installed on the computer can be used for setting the inverter, or monitoring or testing the inverter operation.	85	

## ◆ CC-Link IE Field Network (FR-A800-GF)

Type	Terminal name	Terminal function description	Refer to page
CC-Link IE	PORT 1	Communication can be made via the CC-Link IE Field Network.	110
	PORT 2		

## 2.6.2 Control logic (sink/source) change

Switch the control logic of input signals as necessary.

To change the control logic, change the jumper connector position on the control circuit board.

Connect the jumper connector to the connector pin of the desired control logic.

The control logic of input signals is initially set to the sink logic (SINK) for the type FM inverter.

The control logic of input signals is initially set to the source logic (SOURCE) for the type CA inverter.

(The output signals may be used in either the sink or source logic independently of the jumper connector position.)

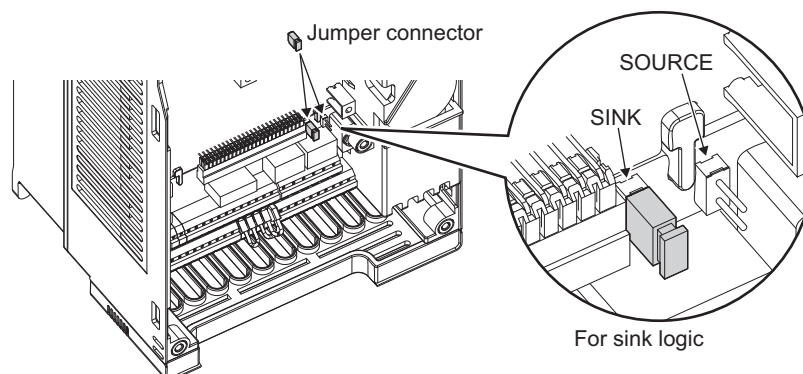

**NOTE**

- Make sure that the jumper connector is installed correctly.
- Never change the control logic while power is ON.
- To change the control logic for the FR-A800-GF, remove the control circuit terminal block and change the jumper connector position. (Refer to [page 819](#) for details on how to remove the terminal block.) After changing the jumper connector position, reinstall the control circuit terminal block securely in place.

**◆ Sink logic and source logic**

- In the sink logic, a signal turns ON when a current exits from the corresponding signal input terminal. Terminal SD is common to the contact input signals. Terminal SE is common to the open collector output signals.
- In the source logic, a signal turns ON when a current enters into the corresponding signal input terminal. Terminal PC is common to the contact input signals. Terminal SE is common to the open collector output signals.

● Current flow concerning the input/output signal when sink logic is selected

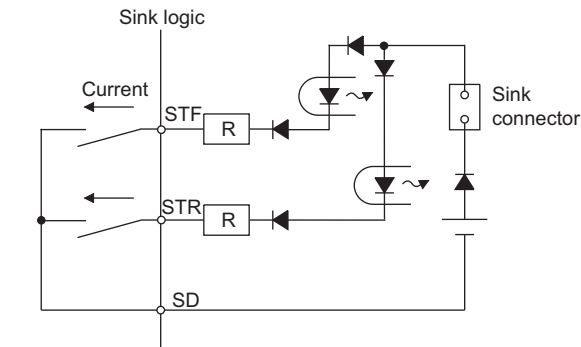

● Current flow concerning the input/output signal when source logic is selected

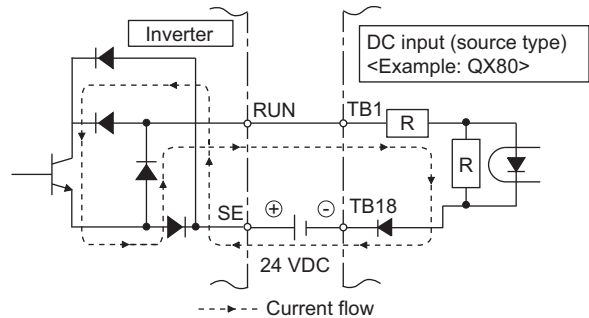
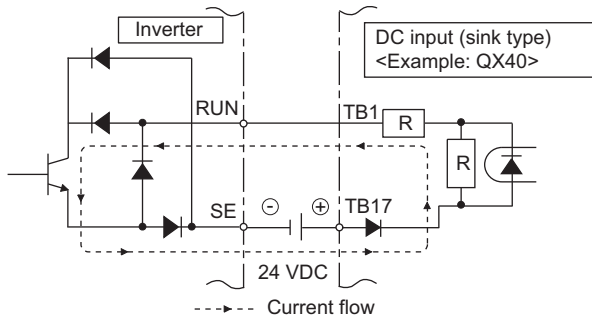
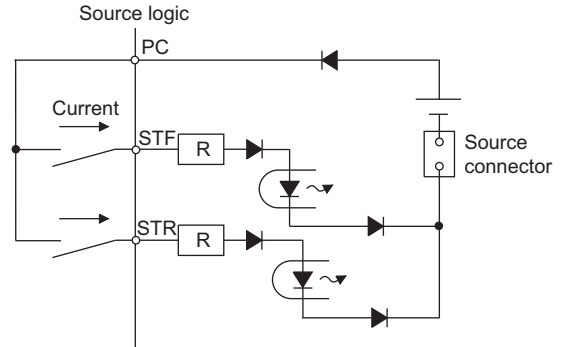

- When using an external power supply for transistor output

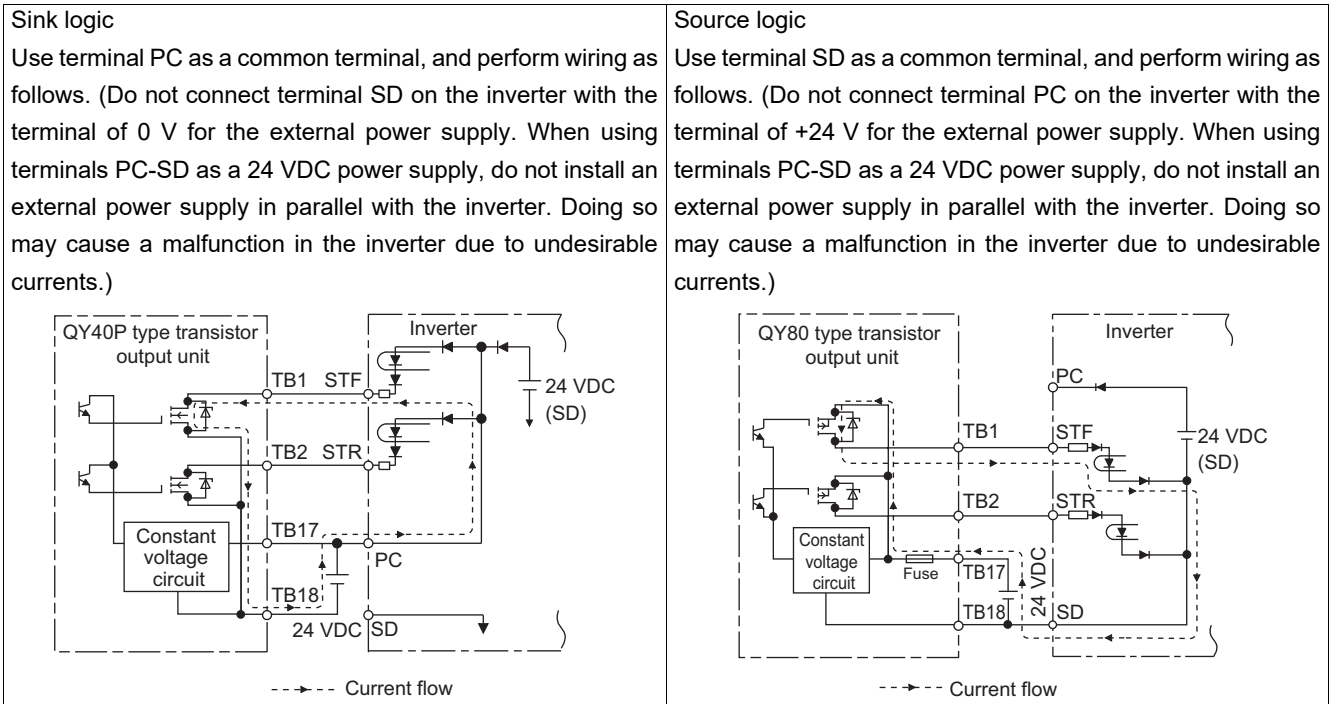

## 2.6.3 Wiring of control circuit

### ◆ Control circuit terminal layout

- Recommended cable gauge: 0.3 to 0.75 mm<sup>2</sup>

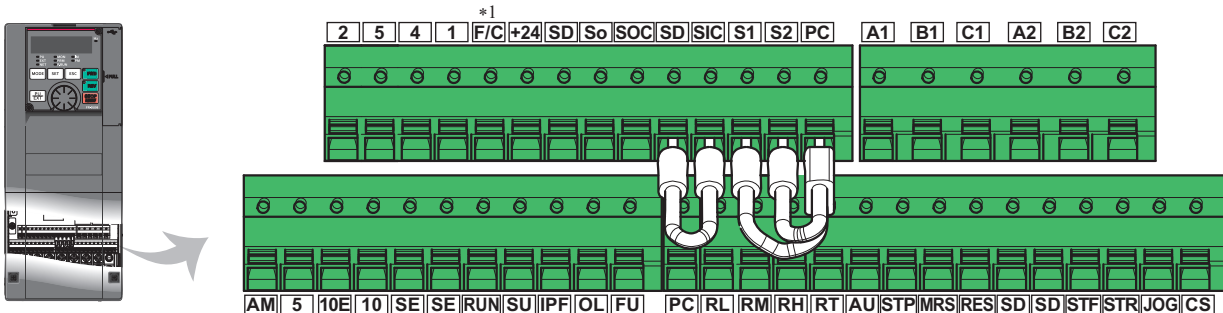

\*1 This terminal operates as terminal FM for the type FM inverter. For the type CA inverter, the terminal operates as terminal CA.

### ◆ Wiring method

#### ■ Power supply connection

Use crimp terminals and stripped wire for the control circuit wiring. For single wire, the stripped wire can be used without crimp terminal.

Connect the end of wires (crimp terminal or stranded wire) to the terminal block.

1. Strip the signal wires as follows. If too much of the wire is stripped, a short circuit may occur with neighboring wires. If not enough of the wire is stripped, wires may become loose and fall out. Twist the stripped end of wires to prevent them from fraying. Do not solder them.

Cable sheath stripping length

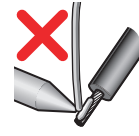
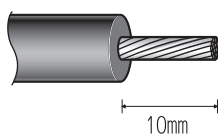

**2.** Crimp the terminals on the wire.

Insert the wire into a crimp terminal, making sure that 0 to 0.5 mm of the wire protrudes from the end of the sleeve. Check the condition of the crimp terminals after crimping. Do not use the crimp terminals of which the crimping is inappropriate, or the face is damaged.

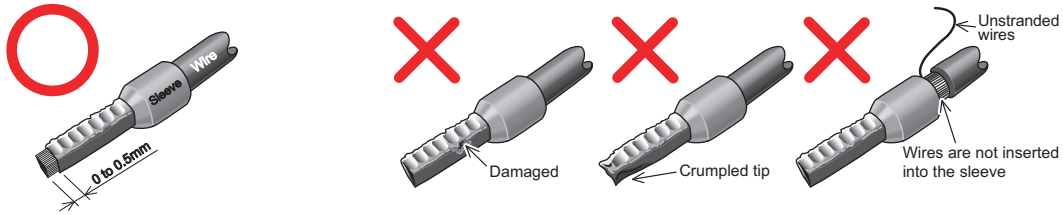

Crimp terminals commercially available (as of October 2020)

- Phoenix Contact Co., Ltd.

Wire gauge (mm <sup>2</sup> )	Ferrule part No.			Crimping tool model No.
	With insulation sleeve	Without insulation sleeve	For UL wire <sup>*1</sup>	
0.3	AI 0,34-10TQ	—	—	CRIMPFOX 6
0.5	AI 0,5-10WH	—	AI 0,5-10WH-GB	
0.75	AI 0,75-10GY	A 0,75-10	AI 0,75-10GY-GB	
1	AI 1-10RD	A 1-10	AI 1-10RD/1000GB	
1.25, 1.5	AI 1, 5-10BK	A 1, 5-10	AI 1,5-10BK/1000GB <sup>*2</sup>	
0.75 (two-wire product)	AI-TWIN 2×0,75-10GY	—	—	

\*1 A ferrule terminal with an insulation sleeve compatible with the MTW wire which has a thick wire insulation.

\*2 Applicable for terminals A1, B1, C1, A2, B2, C2.

- NICHIFU Co., Ltd.

Wire gauge (mm <sup>2</sup> )	Blade terminal part No.	Insulation cap part No.	Crimping tool model No.
0.3 to 0.75	BT 0.75-11	VC 0.75	NH 69

**3.** Insert the wire into the terminal block.

When using single wire or stranded wire without crimp terminal, push an open/close button all the way down with a flathead screwdriver, and insert the wire.

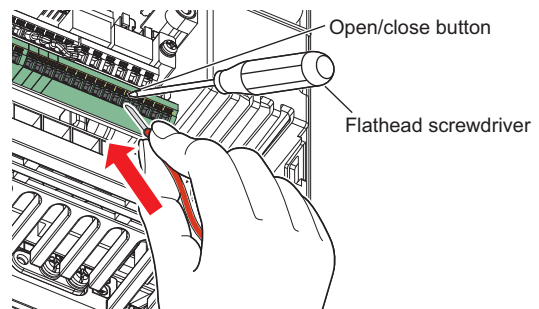
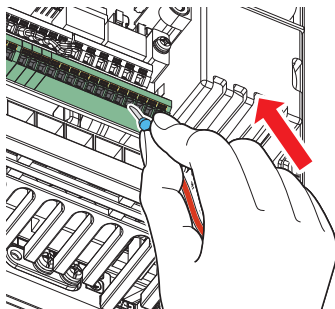

**NOTE**

- When using stranded wires without a blade terminal, twist enough to avoid short circuit with a nearby terminals or wires.
- Place the flathead screwdriver vertical to the open/close button. In case the blade tip slips, it may cause an inverter damage or injury.



## ■ Wire removal

Pull the wire while pushing the open/close button all the way down firmly with a flathead screwdriver.

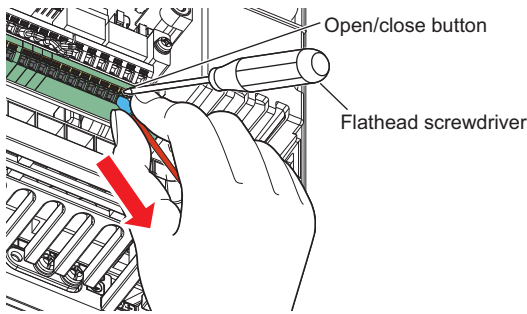

### NOTE

- Pulling out the wire forcefully without pushing the open/close button all the way down may damage the terminal block.
- Use a small flathead screwdriver (tip thickness: 0.4 mm / tip width: 2.5 mm).  
If a flathead screwdriver with a narrow tip is used, terminal block may be damaged.  
Commercially available products (as of October 2020)

Product name	Model	Manufacturer
Screwdriver	SZF 0- 0,4 × 2,5	Phoenix Contact Co., Ltd.

- Place the flathead screwdriver vertical to the open/close button. In case the blade tip slips, it may cause an inverter damage or injury.

## ◆ Common terminals of the control circuit (SD, PC, 5, SE)

- Terminals SD (sink logic), PC (source logic), 5, and SE are common terminals (0 V) for I/O signals. (All common terminals are isolated from each other.) Do not earth (ground) these terminals. Avoid connecting terminal SD (sink logic) with terminal 5, terminal PC (source logic) with terminal 5, and terminal SE with terminal 5.
- In the sink logic, terminal SD is a common terminal for the contact input terminals (STF, STR, STP (STOP), RH, RM, RL, JOG, RT, MRS, RES, AU, and CS) and the pulse train output terminal (FM<sup>\*1</sup>). The open collector circuit is isolated from the internal control circuit by photocoupler.
- In the source logic, terminal PC is a common terminal for the contact input terminals (STF, STR, STP (STOP), RH, RM, RL, JOG, RT, MRS, RES, AU, CS). The open collector circuit is isolated from the internal control circuit by photocoupler.
- Terminal 5 is a common terminal for the frequency setting terminals (1, 2, and 4) and the analog output terminals (AM and CA<sup>\*2</sup>). It should be protected from external noise using a shielded or twisted cable.
- Terminal SE is a common terminal for the open collector output terminals (RUN, SU, OL, IPF, and FU). The contact input circuit is isolated from the internal control circuit by photocoupler.

\*1 Terminal FM is provided in the FM-type inverter.

\*2 Terminal CA is provided in the CA-type inverter.

## ◆ Signal inputs by contactless switches

The contact input terminals of the inverter (STF, STR, STP (STOP), RH, RM, RL, JOG, RT, MRS, RES, AU, and CS) can be controlled using a transistor instead of a contact switch as follows.

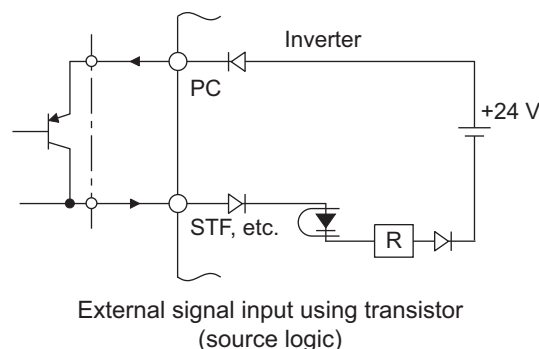
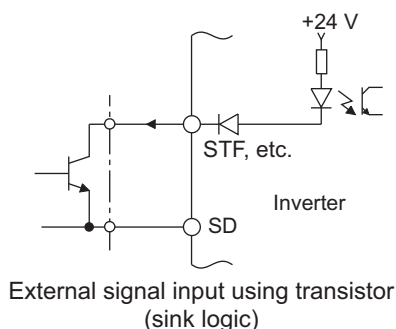

## 2.6.4 Wiring precautions

- It is recommended to use a cable of 0.3 to 0.75 mm<sup>2</sup> for the connection to the control circuit terminals.
- The wiring length should be 30 m (200 m for terminal FM) at the maximum.
- Use two or more parallel micro-signal contacts or twin contacts to prevent contact faults when using contact inputs since the control circuit input signals are micro-currents.

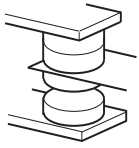

Micro signal contacts

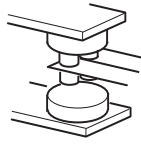

Twin contacts

- To suppress EMI, use shielded or twisted cables for the control circuit terminals and run them away from the main and power circuits (including the 200 V relay sequence circuit). For the cables connected to the control circuit terminals, connect their shields to the common terminal of the connected control circuit terminal. When connecting an external power supply to terminal PC, however, connect the shield of the power supply cable to the negative side of the external power supply. Do not directly earth (ground) the shield to the enclosure, etc.
- Always apply a voltage to the fault output terminals (A1, B1, C1, A2, B2, and C2) via a relay coil, lamp, etc.
- When a relay coil is connected to the output terminals, use one with a surge absorbing function (reflux diode). When the voltage application direction is incorrect, the inverter will be damaged. Pay attention to the diode direction or other precautions to avoid incorrect wiring.

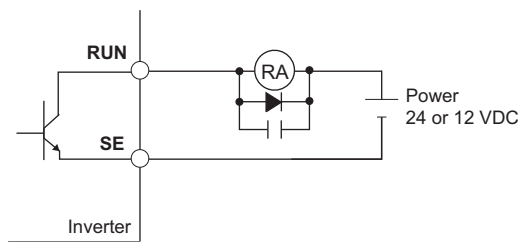

- For the FR-A820-03160(55K) or higher and FR-A840-02160(75K) or higher, separate the wiring of the control circuit away from the wiring of the main circuit.

Make cuts in rubber bush of the inverter side and lead the wires through.

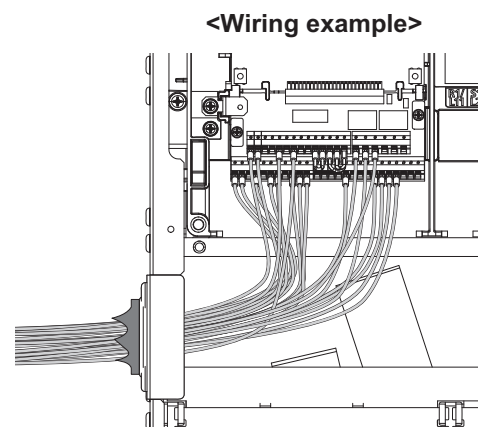
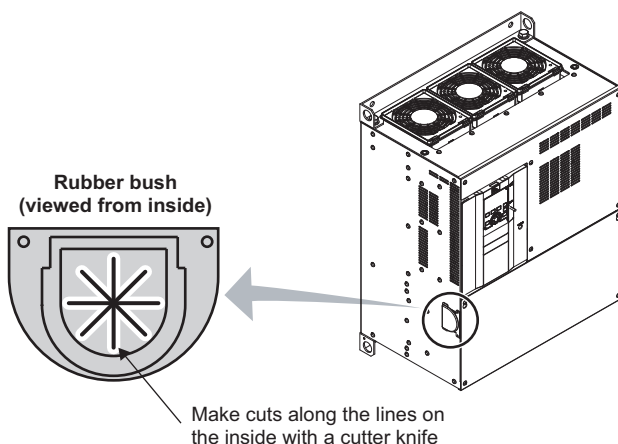

## 2.6.5 When using separate power supplies for the control circuit and the main circuit

### ◆ Cable size for the control circuit power supply (terminals R1/L11 and S1/L21)

- Terminal screw size: M4

- Cable gauge: 0.75 to 2 mm<sup>2</sup>
- Tightening torque: 1.5 N·m

## ◆ Connection method

Connection diagram

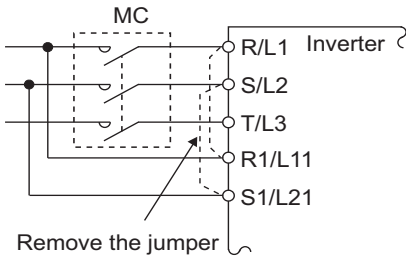

If a fault occurs and the electromagnetic contactor (MC) installed at the inverter's input line is opened, power supply to the control circuit is also stopped and the fault signals cannot be output anymore. Terminals R1/L11 and S1/L21 of the control circuit are provided to keep outputting the fault signals in such a case. Follow the following steps to wire terminals R1/L11 and S1/L21 on the inverter to the power input lines of the MC. Do not connect the power cable to incorrect terminals. Doing so may damage the inverter.

- FR-A820-00250(3.7K) or lower, FR-A840-00126(3.7K) or lower

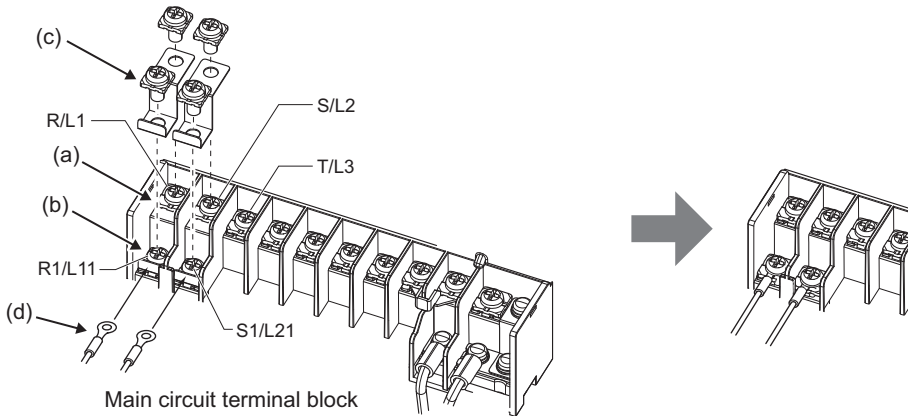

- Remove the upper screws.
- Remove the lower screws.
- Remove the jumper.
- Connect the separate power cable for the control circuit to the lower terminals (R1/L11, S1/L21).

- FR-A820-00340(5.5K) to FR-A820-00630(11K), FR-A840-00170(5.5K) to FR-A840-00380(15K)

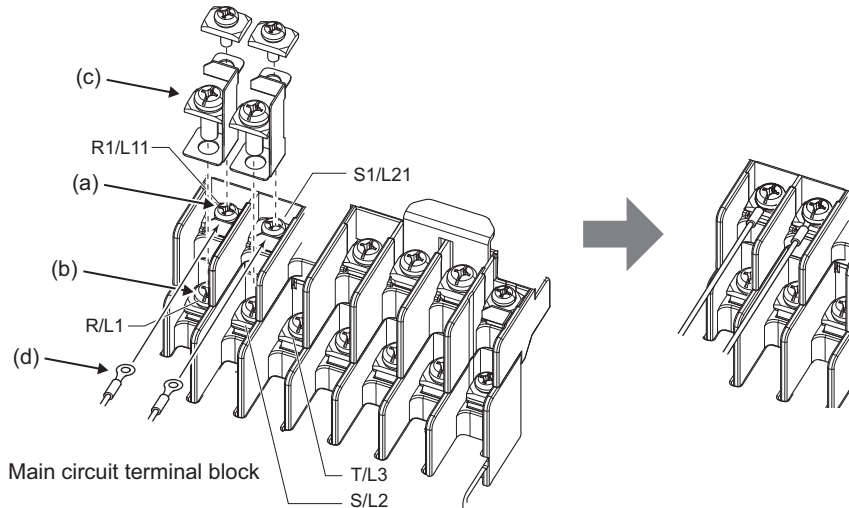

- Remove the upper screws.
- Remove the lower screws.
- Remove the jumper.
- Connect the separate power cable for the control circuit to the upper terminals (R1/L11, S1/L21).

- FR-A820-00770(15K) or higher, FR-A840-00470(18.5K) or higher

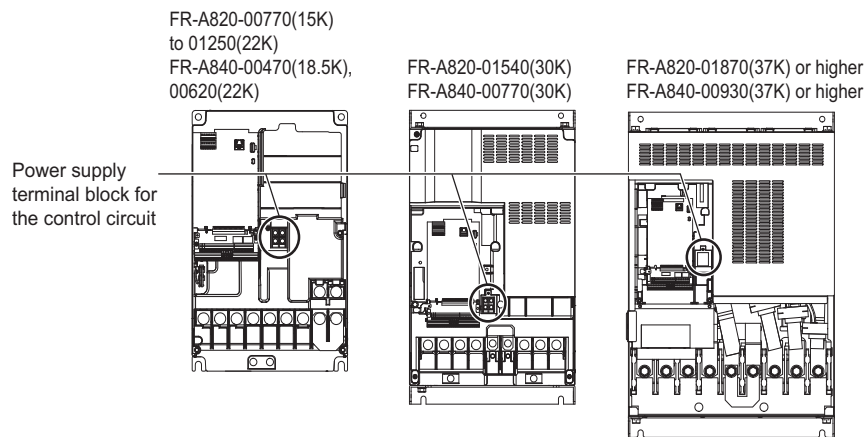
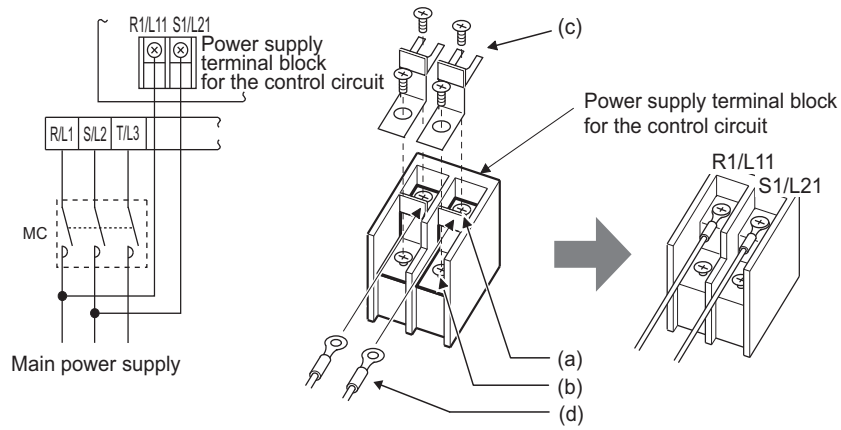

- Remove the upper screws.
- Remove the lower screws.
- Pull the jumper toward you to remove.
- Connect the separate power cable for the control circuit to the upper terminals (R1/L11, S1/L21).

**NOTE**

- When using separate power supplies, always remove the jumpers across terminals R/L1 and R1/L11 and across S/L2 and S1/L21. The inverter may be damaged if the jumpers are not removed.
- When the control circuit power is supplied from other than the input line of the MC, the voltage of the separate power supply must be the same as that of the main control circuit.
- The power capacity necessary when separate power is supplied from R1/L11 and S1/L21 differs according to the inverter capacity.

Inverter	Power supply capacity
FR-A820-00630(11K) or lower FR-A840-00380(15K) or lower	60 VA
FR-A820-00770(15K) or higher FR-A840-00470(18.5K) or higher	80 VA

- If the main circuit power is switched OFF (for 0.1 second or more) then ON again, the inverter is reset and a fault output will not be held.
- When a power supply is provided for the control circuit separately from the main circuit and a capacitive device (such as an EMC filter or a radio noise filter) is connected, refer to the following diagram. (For the wiring example to comply with ship classification standards, refer to [page 858](#).)

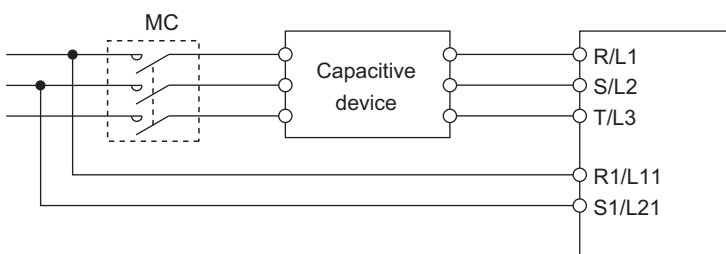

## 2.6.6 When supplying 24 V external power to the control circuit

Connect the 24 V external power supply across terminals +24 and SD to turn the I/O terminal ON/OFF operation, keep the operation panel ON, and carry out communication during communication operation even at power-OFF state of inverter's main circuit power supply. When the main circuit power supply is turned ON, the power supply is switched from the 24 V external power supply to the main circuit power supply.

### ◆ Specification of the applied 24 V external power supply

Item	Rated specification
Input voltage	23 to 25.5 VDC
Input current	1.4 A or less

Commercially available products (as of October 2020)

Model	Product overview	Manufacturer
S8FS-G05024C <sup>*1</sup>	Specifications: Capacity 50 W, output voltage 24 VDC, output current 2.2 A Installation method: Direct installation, screw type terminal block with cover Input: Single-phase 100 to 240 VAC	OMRON Corporation
S8VK-S06024 <sup>*1</sup>	Specifications: Capacity 60 W, output voltage 24 VDC, output current 2.5 A Installation method: DIN rail, push-in (spring) type terminal block Input: Single-phase 100 to 240 VAC	
S8VK-WA24024 <sup>*1</sup>	Specifications: Capacity 240 W, output voltage 24 VDC, output current 10 A Installation method: DIN rail, push-in (spring) type terminal block Input: Three-phase 200 to 240 VAC	

<sup>\*1</sup> For the latest information about OMRON power supply, contact OMRON corporation.

## ◆ Starting and stopping the 24 V external power supply operation

- Supplying 24 V external power while the main circuit power is OFF starts the 24 V external power supply operation. Likewise, turning OFF the main circuit power while supplying 24 V external power starts the 24 V external power supply operation.
- Turning ON the main circuit power stops the 24 V external power supply operation and enables the normal operation.

### NOTE

- When the 24 V external power is supplied while the main circuit power supply is OFF, the inverter operation is disabled.
- In the initial setting, when the main circuit power supply is turned ON during the 24 V external power supply operation, a reset is performed in the inverter, then the power supply changes to the main circuit power supply. (The reset can be disabled using Pr.30. (Refer to page 724.))

## ◆ Confirming the 24 V external power supply input

- During the 24 V external power supply operation, "EV" blinks on the operation panel. The alarm lamp also blinks. Thus, the 24 V external power supply operation can be confirmed even when the operation panel is removed.

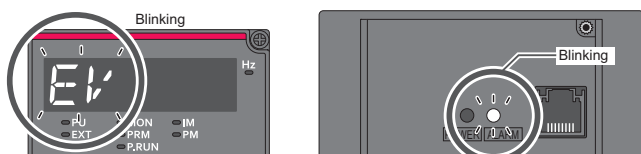

- During 24 V external power supply operation, the 24 V external power supply operation (EV) signal is output. To use the EV signal, set "68 (positive logic) or 168 (negative logic)" in one of Pr.190 to Pr.196 (**Output terminal function selection**) to assign function to an output terminal.

## ◆ Operation while the 24 V external power is supplied

- Fault history and parameters can be read and parameters can be written (when the parameter write from the operation panel is enabled) using the operation panel keys.
- The safety stop function is invalid during the 24 V external power supply operation.
- During the 24 V external power supply operation, the monitor items and signals related to inputs to main circuit power supply, such as the output current, converter output voltage, and IPF signal, are invalid.
- The alarms, which have occurred when the main circuit power supply is ON, continue to be output after the power supply is changed to the 24 V external power supply. Perform the inverter reset or turn OFF then ON the power to reset the faults.
- If the power supply changes from the main circuit power supply to the 24 V external power supply while measuring the main circuit capacitor's life, the measurement completes after the power supply changes back to the main circuit power supply (Pr.259 = "3").
- The output data is retained when "1 or 11" is set in Pr.495 Remote output selection.

### NOTE

- Inrush current equal to or higher than the 24 V external power supply specification may flow at power-ON. Confirm that the power supply and other devices are not affected by the inrush current and the voltage drop caused by it. Depending on the power supply, the overcurrent protection may be activated to disable the power supply. Select the power supply and capacity carefully.
- When the wiring length between the external power supply and the inverter is long, the voltage often drops. Select the appropriate wiring size and length to keep the voltage in the rated input voltage range.
- In a serial connection of several inverters, the current increases when it flows through the inverter wiring near the power supply. The increase of the current causes voltage to drop further. When connecting different inverters to different power supplies, use the inverters after confirming that the input voltage of each inverter is within the rated input voltage range. Depending on the power supply, the overcurrent protection may be activated to disable the power supply. Select the power supply and capacity carefully.
- "E.SAF" or "E.P24" may appear when the start-up time of the 24 V power supply is too long (less than 1.5 V/s) in the 24 V external power supply operation.
- "E.P24" may appear when the 24 V external power supply input voltage is low. Check the external power supply input.
- Do not touch the control circuit terminal block (circuit board) during the 24 V power supply operation (when conducted). Otherwise you may get an electric shock or burn.

## 2.6.7 Safety stop function

### ◆ Function description

The terminals related to the safety stop function are as follows.

Terminal symbol	Terminal function description	
S1 <sup>*1</sup>	Input terminal as the safety stop channel 1.	Status of both the circuit between terminals S1 and SIC and the circuit between terminals S2 and SIC Open: Safety stop is activated. Shorted: Safety stop is not activated
S2 <sup>*1</sup>	Input terminal as the safety stop channel 2.	
SIC <sup>*1</sup>	Common terminal for S1 and S2.	
So (SO)	Output terminal used for fault detection and fault indication display. The terminal is ON (conducted) while no internal safety circuit failure <sup>*2</sup> exists.	OFF: Internal safety circuit fault <sup>*2</sup> ON: No internal safety circuit failure <sup>*2</sup>
SOC	Open collector output (terminal So (SO)) common	

\*1 In the initial status, terminals S1 and PC, S2 and PC, and SIC and SD are respectively shorted with shorting wires. To enable the safety stop function, remove all the shorting wires, and then connect a safety relay module as shown in the connection diagram.

\*2 When any fault listed on the next page occurs in the internal safety circuit, the corresponding indication is shown on the operation panel.

### NOTE

- Terminal So (SO) can be used to display a fault indication and to prevent restarting of the inverter. The signal output from terminal So (SO) cannot be used to input a safety stop signal to other devices.

### ◆ Connection diagram

To prevent restart at failure occurrence, connect terminals So (SO) and SOC to the reset button, which are the feedback input terminals of the safety relay module.

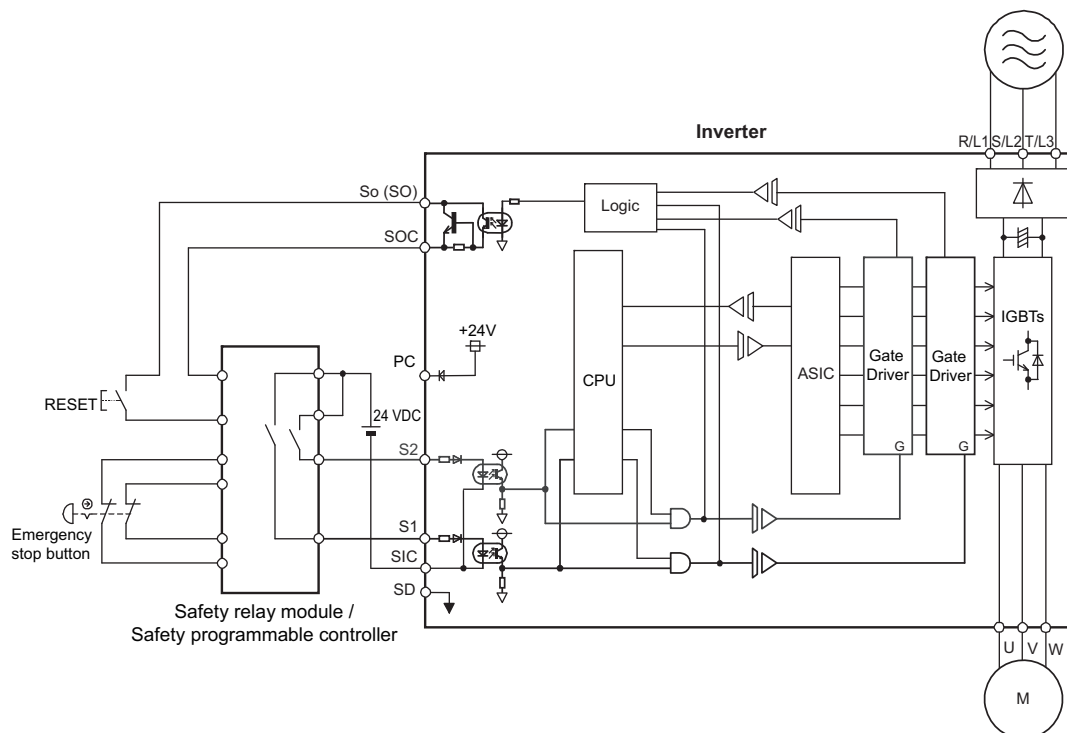

## ◆ Safety stop function operation

Input power	Internal safety circuit status	Input terminal <sup>*1,2</sup>		Output terminal So (SO)	Output signal <sup>*8,9,10</sup> SAFE	Inverter operating status	Operation panel indication	
		S1	S2				E.SAF <sup>*6</sup>	SA <sup>*7</sup>
OFF	—	—	—	OFF	OFF	Output shutoff (Safe state)	Not displayed	Not displayed
ON	Normal	ON	ON	ON <sup>*3</sup>	OFF	Operation enabled	Not displayed	Not displayed
	Normal	ON	OFF	OFF <sup>*4</sup>	OFF <sup>*4</sup>	Output shutoff (Safe state)	Displayed	Displayed
	Normal	OFF	ON	OFF <sup>*4</sup>	OFF <sup>*4</sup>	Output shutoff (Safe state)	Displayed	Displayed
	Normal	OFF	OFF	ON <sup>*3</sup>	ON <sup>*3</sup>	Output shutoff (Safe state)	Not displayed	Displayed
	Fault	ON	ON	OFF	OFF	Output shutoff (Safe state)	Displayed	Not displayed <sup>*5</sup>
	Fault	ON	OFF	OFF	OFF	Output shutoff (Safe state)	Displayed	Displayed
	Fault	OFF	ON	OFF	OFF	Output shutoff (Safe state)	Displayed	Displayed
Fault	OFF	OFF	OFF	OFF	Output shutoff (Safe state)	Displayed	Displayed	

\*1 The terminal ON state shows that the terminal is conducted (the line is closed), and the OFF state shows that the terminal is not conducted (the line is open).

\*2 When not using the safety stop function, short across terminals S1 and PC, S2 and PC, and SIC and SD to use the inverter. (In the initial status, terminals S1 and PC, S2 and PC, and SIC and SD are respectively shorted with shorting wires.)

\*3 If any of the faults shown in the following table occurs, terminal So (SO) and the SAFE signal turn OFF.

Fault type	Operation panel indication
Option fault	E.OPT
Communication option fault	E.OP1 to E.OP3
Parameter storage device fault (control circuit board)	E.PE
Retry count excess	E.RET
Parameter storage device fault (main circuit board)	E.PE2
Operation panel power supply short circuit/RS-485 terminals power supply short circuit	E.CTE
24 VDC power fault	E.P24
Safety circuit fault	E.SAF
Overspeed occurrence	E.OS

Fault type	Operation panel indication
Speed deviation excess detection	E.OSD
Signal loss detection	E.ECT
Excessive position fault	E.OD
Brake sequence fault	E.MB1 to E.MB7
CPU fault	E.CPU
	E.5 to E.7
Encoder phase fault	E.EP
Magnetic pole position unknown	E.MP
Internal circuit fault	E.13

\*4 When the internal safety circuit is operated normally (no faults occurs), terminal So (SO) and the SAFE signal remains ON until "E.SAF" is displayed. Terminal So (SO) and the SAFE signal turns OFF when "E.SAF" is displayed.

\*5 "SA" is displayed when terminals S1 and S2 are identified as OFF due to a fault occurred in the internal safety circuit.

\*6 If another fault occurs when the fault E.SAF occurs, the other fault indication may be displayed.

\*7 If another warning occurs when the warning SA occurs, the other warning indication may be displayed.

\*8 The ON/OFF state of the output signal is the one for the positive logic. The ON and OFF are reversed for the negative logic.

\*9 To assign the function of the SAFE signal to an output terminal, set either value shown in the following table in any of **Pr.190 to Pr.196 (Output terminal function selection)**.

Output signal	Pr.190 to Pr.196 settings	
	Positive logic	Negative logic
SAFE	80	180

\*10 The use of SAFE signal has not been certified for compliance with safety standards.

For more details, refer to the Safety Stop Function Instruction Manual.

Find a PDF file of the manual in the CD-ROM enclosed with the product.

The manual can also be downloaded in PDF form from the Mitsubishi Electric FA Global Website.

[www.MitsubishiElectric.co.jp/fa](http://www.MitsubishiElectric.co.jp/fa)



## 2.7 Communication connectors and terminals

### 2.7.1 PU connector

#### ◆ Mounting the operation panel or the parameter unit on the enclosure surface

- Having an operation panel or a parameter unit on the enclosure surface is convenient. With a connection cable, the operation panel or the parameter unit can be mounted to the enclosure surface and connected to the inverter. Use the cable option FR-CB2[ ] or the following connector and cable available on the market. (To install the operation panel, the optional connector (FR-ADP) is also required.)

Securely insert one end of the cable into the PU connector and the other end into the connection connector on the parameter unit or the FR-ADP attached on the operation panel until the stoppers are fixed.

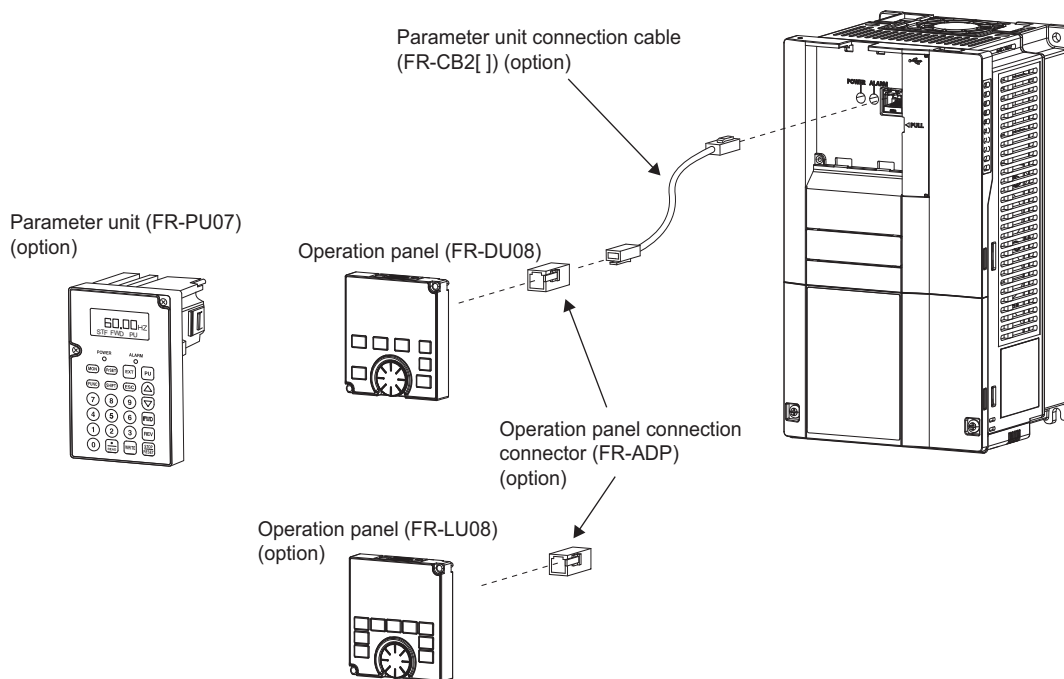

#### NOTE

- Refer to the following table when fabricating the cable on the user side. Keep the total cable length within 20 m.

Name	Remarks
Communication cable	Cable compliant with EIA-568 (such as 10BASE-T cable)

#### ◆ Communication operation

- Using the PU connector as a computer network port enables communication operation from a personal computer, etc. When the PU connector is connected with a personal, FA or other computer by a communication cable, a user program can run to monitor the inverter or read and write parameters. Communication can be performed with the Mitsubishi inverter protocol (computer link operation). For the details, refer to [page 659](#).

## 2.7.2 USB connector

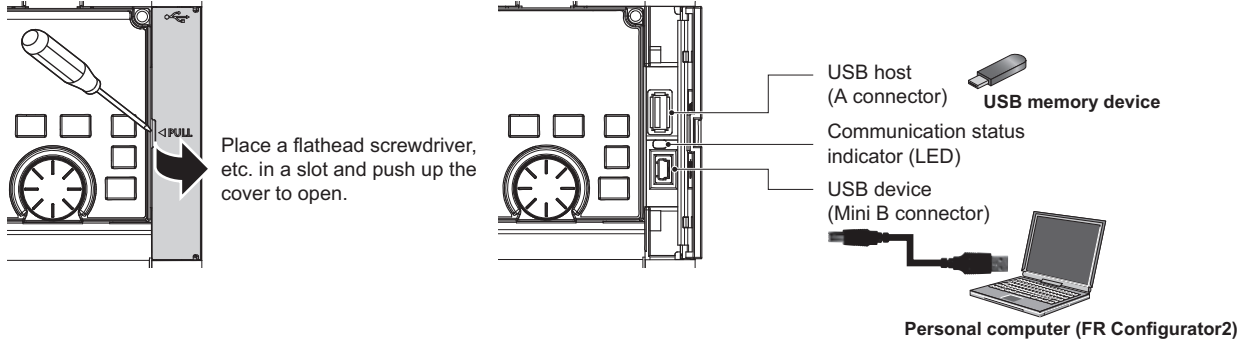

### ◆ USB host communication

<b>Interface</b>		Conforms to USB 1.1
<b>Transmission speed</b>		12 Mbps
<b>Wiring length</b>		Maximum 5 m
<b>Connector</b>		USB A connector (receptacle)
<b>Compatible USB memory</b>	<b>Format</b>	FAT32
	<b>Capacity</b>	1 GB or more (used in the recorder mode of the trace function)
	<b>Encryption function</b>	Not available

- Different inverter data can be saved in a USB memory device.
- The USB host communication enables the following functions.

Function	Description	Refer to page
Parameter copy	<ul style="list-style-type: none"> <li>• Copies the parameter settings from the inverter to the USB memory device. A maximum of 99 parameter setting files can be saved in a USB memory device.</li> <li>• The parameter setting data copied in the USB memory device can be copied to other inverters. This function is useful in backing up the parameter setting or for sharing the parameter setting among multiple inverters.</li> <li>• The parameter setting file can be copied onto a personal computer from the USB memory device and edited using FR Configurator2.</li> </ul>	747
Trace	<ul style="list-style-type: none"> <li>• The monitoring data and output status of the signals can be saved in a USB memory device.</li> <li>• The saved data can be imported to FR Configurator2 to diagnose the operating status of the inverter.</li> </ul>	649
PLC function data copy	<ul style="list-style-type: none"> <li>• This function copies the PLC function project data to a USB memory device when the PLC function is used.</li> <li>• The PLC function project data copied in the USB memory device can be copied to other inverters.</li> <li>• This function is useful in backing up the parameter setting and for allowing multiple inverters to operate by the same sequence programs.</li> </ul>	646

- When the inverter recognizes the USB memory device without any problem, "USB--A" is briefly displayed on the operation panel.
- When the USB memory device is removed, "USB--" is briefly displayed on the operation panel.
- The operating status of the USB host can be checked on the LED display of the inverter.

LED display status	Operating status
OFF	No USB connection.
ON	The communication is established between the inverter and the USB device.
Fast blinking	The USB memory device is being accessed. (Do not remove the USB memory device.)
Slow blinking	Error in the USB connection.

- When a device such as a USB charger is connected to the USB connector and an excessive current (500 mA or higher) flows, USB host error "UF" (UF warning) is displayed on the operation panel.
- When the UF warning appears, the USB error can be canceled by removing the USB device and setting Pr.1049 = "1". (The UF warning can also be canceled by resetting the inverter power or resetting with the RES signal.)

**NOTE**

- Do not connect devices other than a USB memory device to the inverter.
- If a USB device is connected to the inverter via a USB hub, the inverter cannot recognize the USB memory device properly.

**◆ USB device communication**

The inverter can be connected to a personal computer with a USB (ver. 1.1) cable. Parameter setting and monitoring can be performed by using FR Configurator2.

<b>Interface</b>	Conforms to USB 1.1
<b>Transmission speed</b>	12 Mbps
<b>Wiring length</b>	Maximum 5 m
<b>Connector</b>	USB mini B connector (receptacle)
<b>Power supply</b>	Self-powered

**NOTE**

- For details on FR Configurator2, refer to the Instruction Manual of FR Configurator2.

**2.7.3 RS-485 terminal block**

**◆ Communication operation**

<b>Conforming standard</b>	EIA-485 (RS-485)
<b>Transmission format</b>	Multidrop link
<b>Communication speed</b>	maximum 115200 bps
<b>Overall length</b>	500 m
<b>Connection cable</b>	Twisted pair cable (4 pairs)

The RS-485 terminals enable communication operation from a personal computer, etc. When the PU connector is connected with a personal, FA or other computer by a communication cable, a user program can run to monitor the inverter or read and write parameters.

Communication can be performed with the Mitsubishi inverter protocol (computer link operation) and MODBUS RTU protocol. For the details, refer to [page 661](#).

**Terminating resistor switch**  
Initially-set to "OPEN".  
Set only the terminating resistor switch of the remotest inverter to the "100Ω" position.

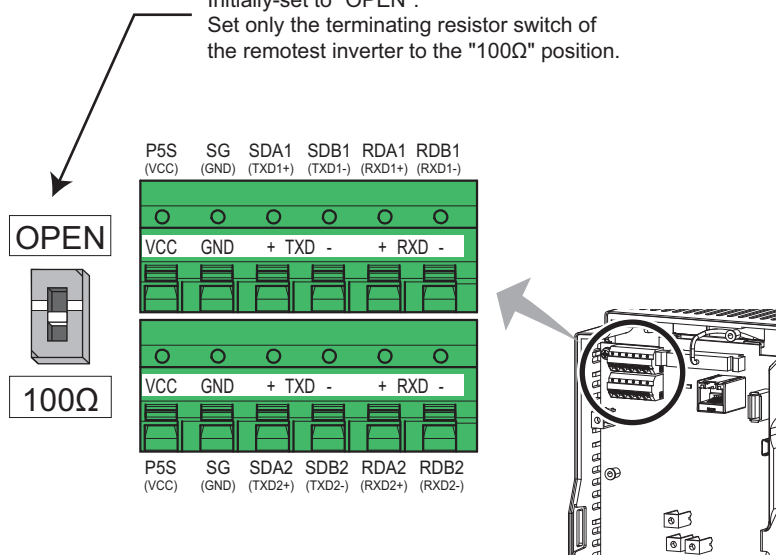

## 2.8 Connection to a motor with encoder (Vector control)

Using encoder-equipped motors together with a Vector control compatible option enables speed, torque, and positioning control operations under orientation control, encoder feedback control, and full-scale Vector control.

This section explains wiring for use of the FR-A8AP.

### ◆ Appearance and parts name of the FR-A8AP

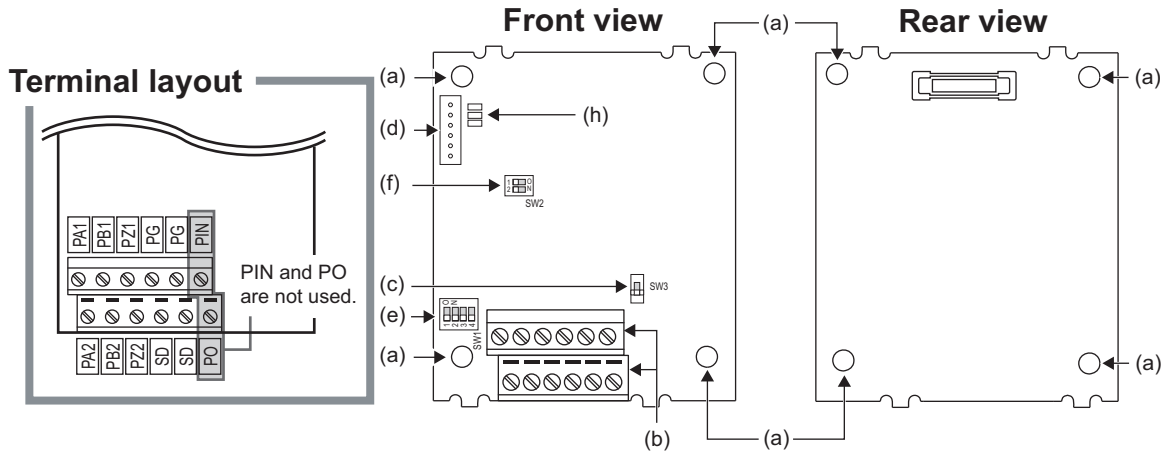

Symbol	Name	Description	Refer to page
(a)	Mounting hole	Used for installation to the inverter.	—
(b)	Terminal block	Connected with the encoder.	91
(c)	Encoder type selection switch (SW3)	Switches the encoder type (differential line driver/complementary).	88
(d)	CON2 connector	Used for extension.	—
(e)	Terminating resistor selection switches (SW1)	Switch ON or OFF the internal terminating resistor.	88
(f)	Switches (SW2) for manufacturer setting	Do not change the initial setting (both SW2-1 and SW2-2 switches: OFF setting).	—
(g)	Board mounted option connector	Used to connect this product to the option connector on the inverter.	19
(h)	LED for manufacturer check	Not used.	—

### ◆ Terminals of the FR-A8AP

Terminal symbol	Terminal name	Description
PA1	Encoder A-phase signal input terminal	A-, B- and Z-phase signals are input from the encoder.
PA2	Encoder A-phase inverse signal input terminal	
PB1	Encoder B-phase signal input terminal	
PB2	Encoder B-phase inverse signal input terminal	
PZ1	Encoder Z-phase signal input terminal	
PZ2	Encoder Z-phase inverse signal input terminal	
PG	Encoder power supply (positive) input terminal	Input terminal for the encoder power supply.
SD	Encoder power supply ground terminal	Connect the external power supply and the encoder power cable. When the encoder output is the differential line driver type, only 5 V can be input. Make the voltage of the external power supply same as the encoder output voltage. (Check the encoder specification.)
PIN	Not used.	
PO		

#### NOTE

- When the encoder's output voltage differs from its input power supply voltage, the signal loss detection (E.ECT) may occur.
- Incorrect wiring or faulty setting to the encoder will cause a fault such as an overcurrent (E.OC[ ] ) and an inverter overload (E.THT). Correctly perform the encoder wiring and setting.

## ◆ Switches on the FR-A8AP

- Use the encoder type selection switch (SW3) to select the differential line driver or the complementary. It is initially set to the differential line driver. Switch its position according to the output circuit.

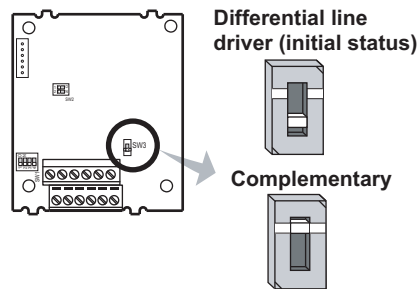

- Use the terminating resistor selection switches (SW1) to select ON/OFF of the internal terminating resistor. Set the switches ON (initial status) when an encoder output type is differential line driver, and set OFF when complementary.

ON: With internal terminating resistor (initial status)

OFF: Without internal terminating resistor

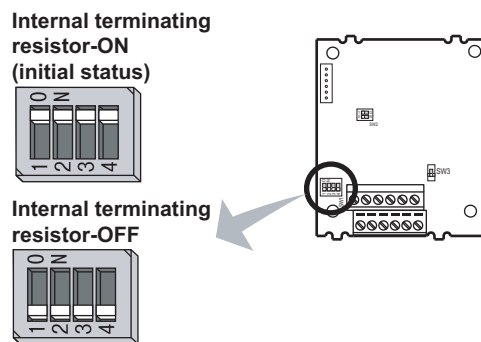

### NOTE

- Set all switches to the same setting (ON/OFF).
- Set the switches OFF when sharing an encoder with another unit (NC (computerized numerical controller), etc.) having a terminating resistor under the differential line driver setting.

- Motor and switch setting

Motor		Encoder type selection switch (SW3)	Terminating resistor selection switches (SW1)	Power supply specification <sup>*2</sup>
Mitsubishi Electric standard motor with encoder	SF-JR	Differential	ON	5 V
	SF-HR	Differential	ON	5 V
Mitsubishi Electric high-efficiency motor with encoder	Others	*1	*1	*1*3
Mitsubishi Electric constant-torque motor with encoder	SF-JRCA	Differential	ON	5 V
	SF-HRCA	Differential	ON	5 V
	Others	*1	*1	*1*3
Vector control dedicated motor	SF-V5RU	Complementary	OFF	12 V
Other manufacturer's motor with encoder		*1	*1	*1*3

\*1 Set according to the motor (encoder).

\*2 Prepare the power supply (5 V/12 V/15 V/24 V) for the encoder according to the encoder's output voltage. When the control terminal option FR-A8TP is installed, 24 V power supply can be provided from the FR-A8TP.

\*3 When the encoder output is the differential line driver type, only 5 V can be input.

### NOTE

- The SW2 switches are for manufacturer setting. Do not change the setting.
- When the power supply of the inverter is turned OFF, also turn off the power supply of the encoder. Otherwise, the plug-in option may be damaged.

- Encoder specifications

Item	Encoder for SF-JR	Encoder for SF-V5RU
Resolution	1024 pulses/rev	2048 pulse/rev
Power supply voltage	5 VDC $\pm$ 10%	12 VDC $\pm$ 10%, 24 VDC $\pm$ 10%
Current consumption	150 mA	150 mA
Output signal form	Phase A and Phase B: 90 degrees out of phase, Phase Z: 1 pulse/rev	Phase A and Phase B: 90 degrees out of phase, Phase Z: 1 pulse/rev
Output circuit	Differential line driver AM26LS31 equivalent	Complementary
Output voltage	H level: 2.4 V or more, L level: 0.5 V or less	H level: (Power supply for encoder - 3 V) or more, L level: 3 V or less

## Encoder cable

### SF-JR/HR/JRCA/HRCA with encoder

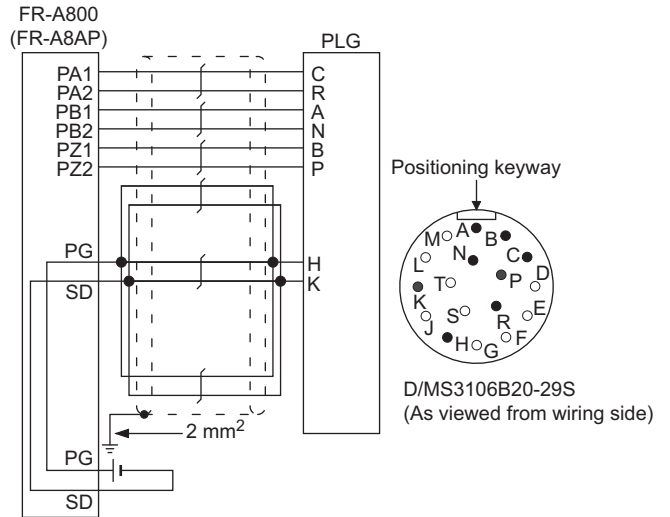
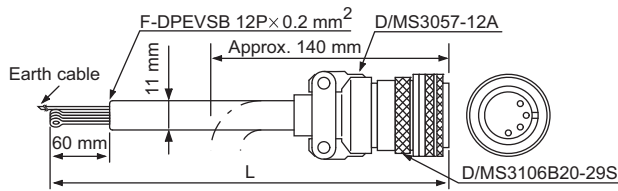

Model	Length L (m)
FR-JCBL5	5
FR-JCBL15	15
FR-JCBL30	30

### SF-V5RU, SF-THY

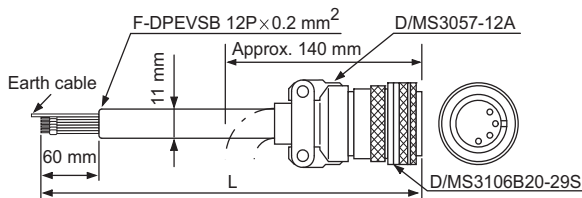

A P clip for earthing (grounding) a shielded cable is provided.

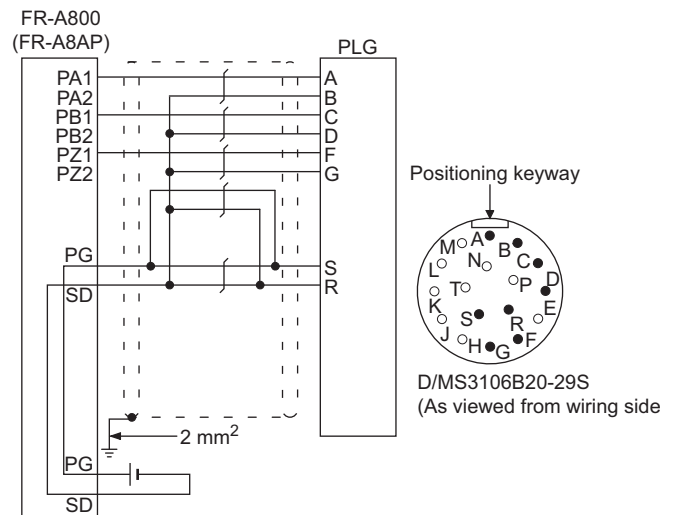

Model	Length L (m)
FR-V7CBL5	5
FR-V7CBL15	15
FR-V7CBL30	30

- When using an encoder cable (FR-JCBL, FR-V5CBL, etc.) dedicated to the conventional motor, the cables need to be treated as the terminal block of the FR-A8AP is an insertion type. Cut the crimp terminal of the encoder cable and strip its sheath to make its cable wires loose. Also, treat the shielding wires of the shielded twisted pair cable to ensure that they do not contact conductive areas.

Wire the stripped cable after twisting it to prevent it from becoming loose. In addition, do not solder it.

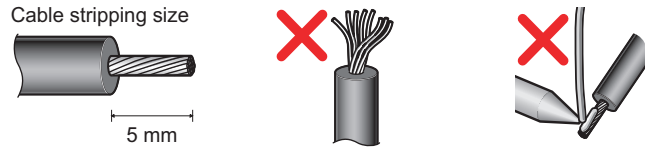

**NOTE**

- Information on crimp terminals  
Commercially available products (as of October 2020)  
Phoenix Contact Co., Ltd.

Terminal screw size	Wire gauge (mm <sup>2</sup> )	Ferrule part No.		Crimping tool model No.
		With insulation sleeve	Without insulation sleeve	
M2	0.3	AI 0,34-6TQ	A 0,34-7	CRIMPFOX 6
	0.5	AI 0,5-6WH	A 0,5-6	

NICHIFU Co., Ltd.

Terminal screw size	Wire gauge (mm <sup>2</sup> )	Blade terminal part No.	Insulation cap part No.	Crimping tool model No.
M2	0.3 to 0.75	BT 0.75-7	VC 0.75	NH 69

- When using a blade terminal (without insulation sleeve), take caution that the twisted wires do not come out.

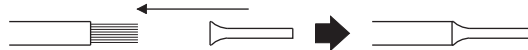

- Connection terminal compatibility table

Motor	SF-V5RU, SF-THY		SF-JR/HR/JRCA/HRCA (with encoder)
	Encoder cable	FR-V7CBL	FR-JCBL
FR-A8AP terminal	PA1	PA	PA
	PA2	Do not connect anything to this.	PAR
	PB1	PB	PB
	PB2	Do not connect anything to this.	PBR
	PZ1	PZ	PZ
	PZ2	Do not connect anything to this.	PZR
	PG	PG	5E
	SD	SD	AG2

## ◆ Wiring example

- Speed control

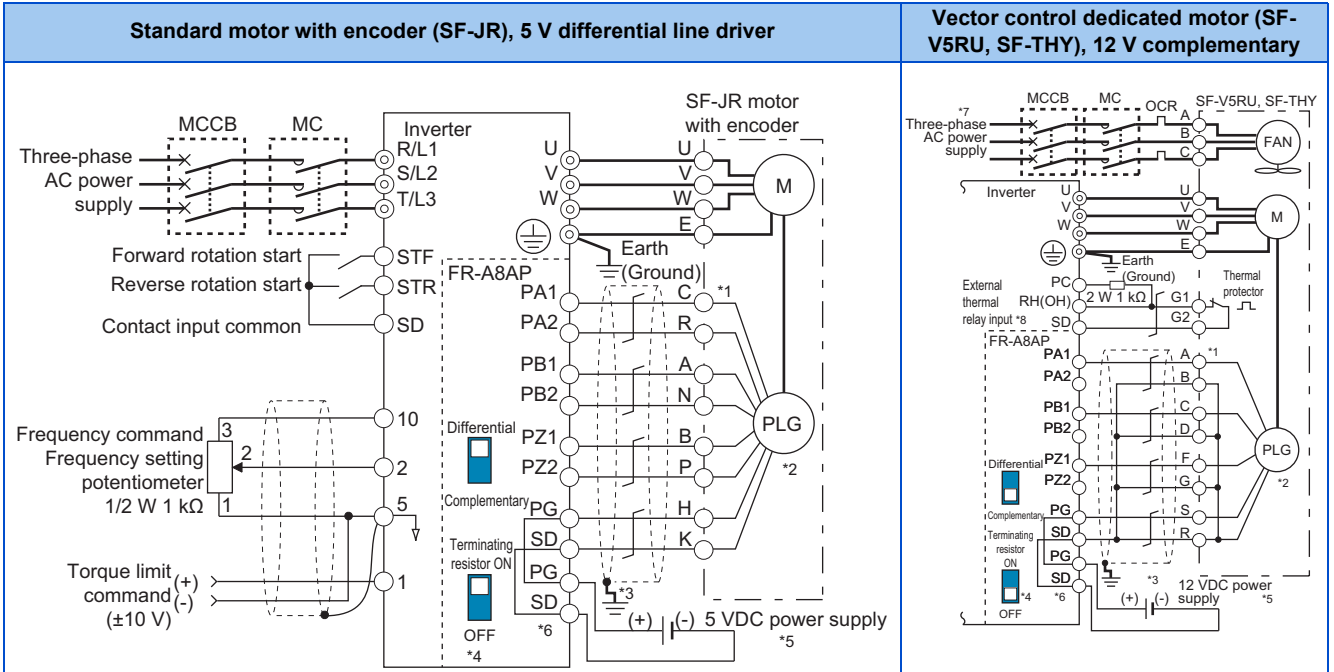

- Torque control

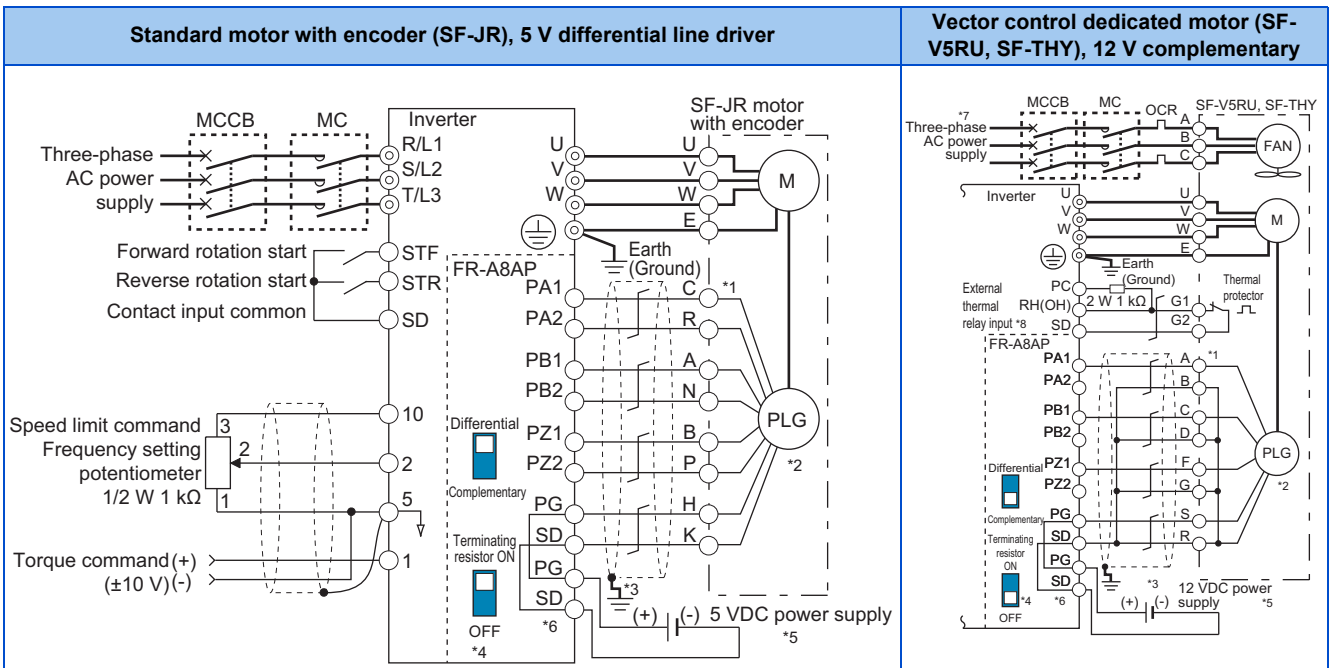



• Position control

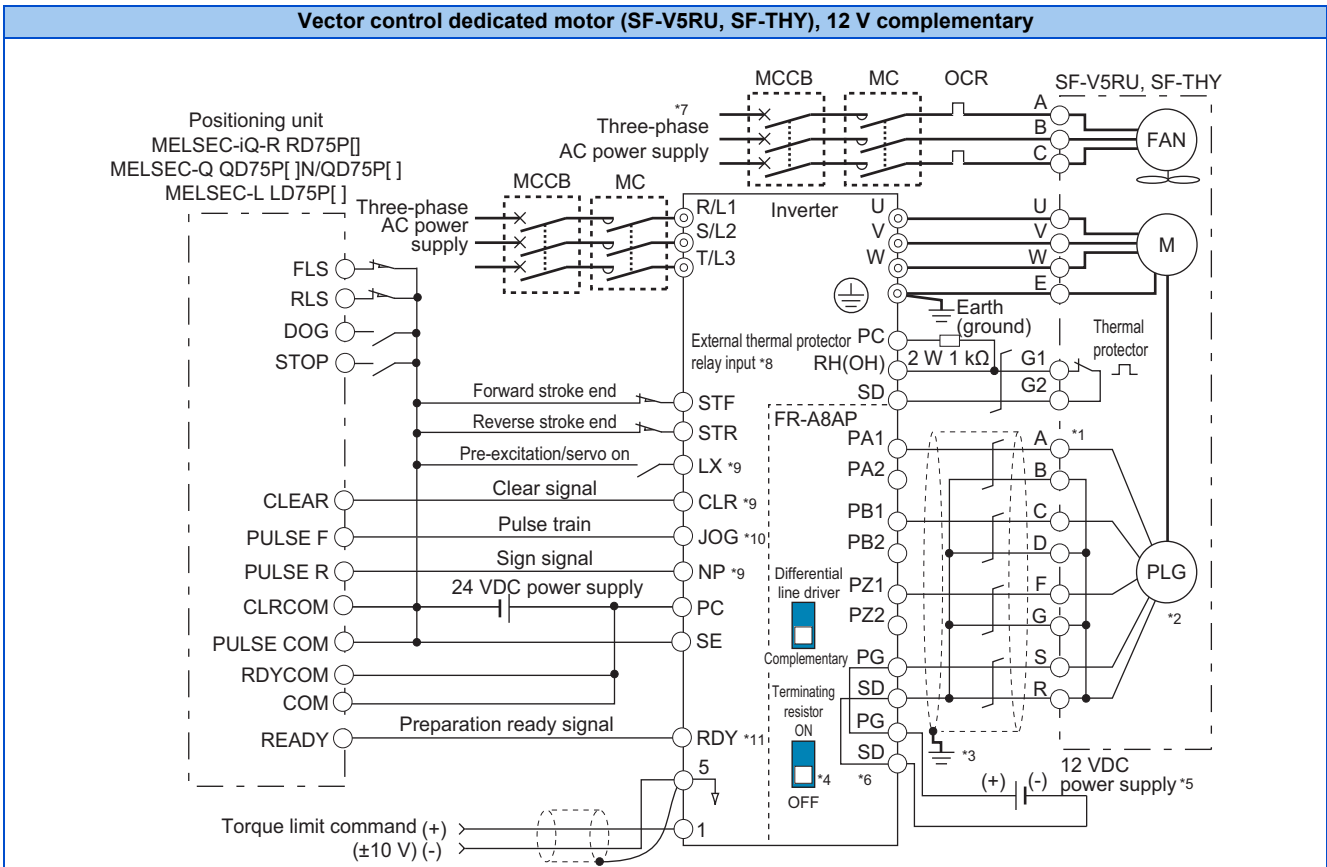

- \*1 The pin number differs according to the encoder used.  
Speed, control, torque control, and position control by pulse train input are available with or without the Z-phase being connected.
- \*2 Connect the encoder so that there is no looseness between the motor and motor shaft. Speed ratio must be 1:1.
- \*3 Earth (ground) the shield of the encoder cable to the enclosure using a tool such as a P-clip. (Refer to [page 93](#).)
- \*4 For the complementary, set the terminating resistor selection switches in the OFF position. (Refer to [page 88](#).)
- \*5 A separate external power supply is necessary according to the encoder power specification.  
When the encoder output is the differential line driver type, only 5 V can be input.  
Make the voltage of the external power supply the same as the encoder output voltage, and connect the external power supply between terminals PG and SD.
- \*6 For terminal compatibility of the FR-JCBL, FR-V7CBL, and FR-A8AP, refer to [page 90](#).
- \*7 Single-phase power supply (200 V/50 Hz, 200 to 230 V/60 Hz) is used for the fan for a 7.5 kW or lower dedicated motor.
- \*8 Connect the recommended 2W1kΩ resistor between terminals PC and OH. (Recommended product: MOS2C102J 2W1kΩ by KOA Corporation)  
Insert the input line and the resistor to a 2-wire blade terminal, and connect the blade terminal to terminal OH. (For the recommended 2-wire blade terminals, refer to [page 74](#).)  
Insulate the lead wire of the resistor, for example by applying a contraction tube, and shape the wires so that the resistor and its lead wire do not touch other cables. Caulk the lead wire securely together with the thermal protector input line using a 2-wire blade terminal. (Do not subject the lead wire's bottom area to an excessive pressure.)  
To use a terminal as terminal OH, assign the OH (External thermal relay input) signal to an input terminal. (Set "7" in any of **Pr.178 to Pr.189**. For details, refer to [page 521](#).)

When OH signal is assigned to terminal RH (Pr.182 = "7")

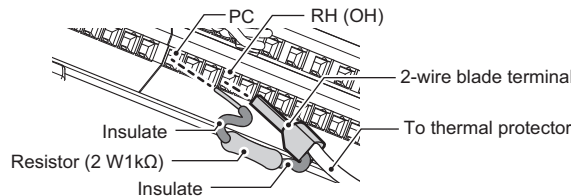

- \*9 Assign the function using **Pr.178 to Pr.184, Pr.187 to Pr.189 (Input terminal function selection)**.
- \*10 When position control is selected, terminal JOG function is invalid and simple position pulse train input terminal becomes valid.
- \*11 Assign the function using **Pr.190 to Pr.194 (Output terminal function selection)**.

## ◆ Instructions for encoder cable wiring

- Use shielded twisted pair cables (0.2 mm<sup>2</sup> or larger) to connect the FR-A8AP. For the wiring to terminals PG and SD, use several cables in parallel or use a thick cable, according to the wiring length. To protect the cables from noise, run them away from any source of noise (such as the main circuit and power supply voltage).

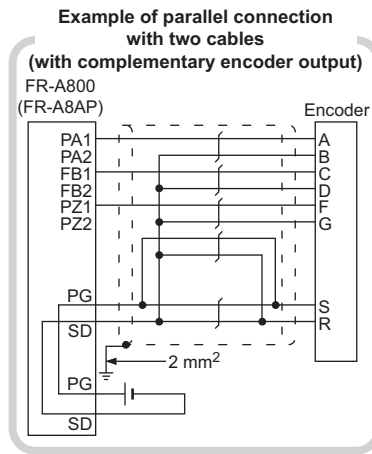

Wiring length	Parallel connection	Larger-size cable
Within 10 m	At least two cables in parallel	Wire gauge 0.2 mm <sup>2</sup>
Within 20 m	At least four cables in parallel	
Within 100 m <sup>*1</sup>	At least six cables in parallel	
		0.4 mm <sup>2</sup> or larger
		0.75 mm <sup>2</sup> or larger
		1.25 mm <sup>2</sup> or larger

\*1 When differential line driver is set and a wiring length is 30 m or more.

The wiring length can be extended to 100 m by increasing the 5 V power supply (approximately to 5.5 V) while using six or more 0.2 mm<sup>2</sup> gauge cables in parallel or a 1.25 mm<sup>2</sup> or larger gauge cable. The voltage applied must be within power supply specifications of encoder.

- To reduce noise of the encoder cable, earth (ground) the encoder's shielded cable to the enclosure (as close as possible to the inverter) with a metal P-clip or U-clip.

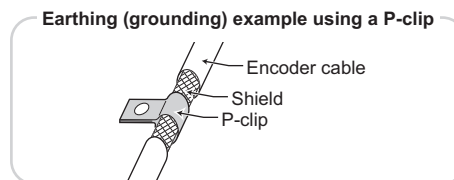

- When one encoder is shared between the FR-A8AP and CNC (computerized numerical controller), its output signal should be connected as follows. In this case, the wiring length between the FR-A8AP and CNC should be as short as possible, within 5 m.

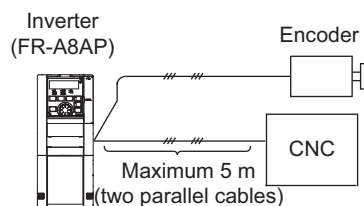



### NOTE

- For details on the optional encoder dedicated cable (FR-JCBL/FR-V7CBL), refer to [page 89](#).
- The FR-V7CBL is provided with a P-clip for earthing (grounding) shielded cables.

## 2.9 Parameter settings for a motor with encoder

### ◆ Parameters for the encoder (Pr.359, Pr.369, Pr.851, Pr.852)

- Set the encoder specifications.

Pr.		Name	Initial value	Setting range	Description
359 C141	852 C241	Encoder rotation direction	1	0	Set when using a motor for which forward rotation (encoder) is clockwise (CW) viewed from the shaft
				100	 Set for the operation at 120 Hz or less. Set for the operation at a frequency higher than 120 Hz.
				1	Set when using a motor for which forward rotation (encoder) is counterclockwise (CCW) viewed from the shaft.
				101	 Set for the operation at 120 Hz or less. Set for the operation at a frequency higher than 120 Hz.
369 C140	851 C240	Number of encoder pulses	1024	0 to 4096	Set the number of encoder pulses. Set the number of pulses before it is multiplied by 4.

The parameters above can be set when a Vector control compatible option is installed.

- The following table shows parameters to be set according to the Vector control compatible option to be used.

Item	FR-A8AP/FR-A8AL/FR-A8APA parameter	FR-A8APR parameter	FR-A8APS parameter	FR-A8TP parameter
Encoder/Resolver rotation direction	<b>Pr.359</b>			<b>Pr.852</b>
Number of detector pulses	<b>Pr.369</b>	— (fixed pulses of 1024)	— (obtained via communication from the encoder)	<b>Pr.851</b>

## ◆ Parameter settings for the motor under Vector control

Motor model		Pr.9 Electronic thermal O/L relay	Pr.71 Applied motor	Pr.80 Motor capacity	Pr.81 Number of motor poles	Pr.359/Pr.852 Encoder rotation direction	Pr.369/Pr.851 Number of encoder pulses
Mitsubishi Electric standard motor	SF-JR	Rated motor current	0 (initial value)	Motor capacity	Number of motor poles	1 (initial value)	1024 (initial value)
	SF-JR 4P 1.5 kW or lower	Rated motor current	20	Motor capacity	4	1 (initial value)	1024 (initial value)
	SF-HR	Rated motor current	40	Motor capacity	Number of motor poles	1 (initial value)	1024 (initial value)
	Others	Rated motor current	0 (3) <sup>*1</sup>	Motor capacity	Number of motor poles	<sup>*2</sup>	<sup>*2</sup>
Mitsubishi Electric constant-torque motor	SF-JRCA 4P	Rated motor current	1	Motor capacity	4	1 (initial value)	1024 (initial value)
	SF-HRCA	Rated motor current	50	Motor capacity	Number of motor poles	1 (initial value)	1024 (initial value)
	Others	Rated motor current	1 (13) <sup>*1</sup>	Motor capacity	Number of motor poles	<sup>*2</sup>	<sup>*2</sup>
Vector control dedicated motor	SF-V5RU (1500 r/min series)	0 <sup>*3</sup>	30	Motor capacity	4	1 (initial value)	2048
	SF-V5RU (other than the 1500 r/min series)	0 <sup>*3</sup>	1 (13) <sup>*1</sup>	Motor capacity	4	1 (initial value)	2048
	SF-THY	0 <sup>*3</sup>	30 (33) <sup>*1</sup>	Motor capacity	4	1 (initial value)	2048
Other manufacturer's standard motor	—	Rated motor current	0 (3) <sup>*1</sup>	Motor capacity	Number of motor poles	<sup>*2</sup>	<sup>*2</sup>
Other manufacturer's constant-torque motor	—	Rated motor current	1 (13) <sup>*1</sup>	Motor capacity	Number of motor poles	<sup>*2</sup>	<sup>*2</sup>
PM motor		Refer to the Instruction Manual of the FR-A8APR.					

\*1 Offline auto tuning is required. (Refer to page 532.)

\*2 Set this parameter according to the motor.

\*3 Use the thermal protector input provided with the motor.

- When using the inverter with the SF-V5RU (1500 r/min series), refer to the following table to set **Pr.83 Rated motor voltage** and **Pr.84 Rated motor frequency**.

Motor capacity	SF-V5RU				Motor capacity	SF-V5RU			
	200 V		400 V			200 V		400 V	
	Pr.83 (V)	Pr.84 (Hz)	Pr.83 (V)	Pr.84 (Hz)		Pr.83 (V)	Pr.84 (Hz)	Pr.83 (V)	Pr.84 (Hz)
1.5 kW	188	52	345	52	18.5 kW	171	51	346	51
2.2 kW	188	52	360	52	22 kW	160	51	336	51
3.7 kW	190	52	363	52	30 kW	178	51	328	51
5.5 kW	165	51	322	51	37 kW	166	51	332	51
7.5 kW	164	51	331	51	45 kW	171	51	342	51
11 kW	171	51	320	51	55 kW	159	51	317	51
15 kW	164	51	330	51					

- When using the inverter with the SF-V5RU1, SF-V5RU3, or SF-V5RU4, refer to the following table to set **Pr.83 Rated motor voltage** and **Pr.84 Rated motor frequency**.

Motor model	Pr.83 setting		Pr.84 setting
	200 V class	400 V class	
SF-V5RU1-30kW or lower	160 V	320 V	33.33 Hz
SF-V5RU1-37kW	170 V	340 V	
SF-V5RU3-22kW or lower	160 V	320 V	
SF-V5RU3, 30kW	170 V	340 V	
SF-V5RU4-3.7kW and 7.5kW	150 V	300 V	16.67 Hz
SF-V5RU4 and motors other than described above	160 V	320 V	

## ◆ Combination with the Vector control dedicated motor

When using the inverter with a Vector control dedicated motor, refer to the following table.

- Combination with the SF-V5RU and SF-THY (ND rating)

Voltage	200 V class			400 V class		
Rated speed	1500 r/min					
Base frequency	50 Hz					
Maximum speed	3000 r/min					
Motor capacity	Motor frame No.	Motor model	Inverter model FR-A820-[]	Motor frame No.	Motor model	Inverter model FR-A840-[]
1.5 kW	90L	SF-V5RU1K	00167(2.2K)	90L	SF-V5RUH1K	00083(2.2K)
2.2 kW	100L	SF-V5RU2K	00250(3.7K)	100L	SF-V5RUH2K	00083(2.2K)
3.7 kW	112M	SF-V5RU3K	00340(5.5K)	112M	SF-V5RUH3K	00126(3.7K)
5.5 kW	132S	SF-V5RU5K	00490(7.5K)	132S	SF-V5RUH5K	00250(7.5K)
7.5 kW	132M	SF-V5RU7K	00630(11K)	132M	SF-V5RUH7K	00310(11K)
11 kW	160M	SF-V5RU11K	00770(15K)	160M	SF-V5RUH11K	00380(15K)
15 kW	160L	SF-V5RU15K	00930(18.5K)	160L	SF-V5RUH15K	00470(18.5K)
18.5 kW	180M	SF-V5RU18K	01250(22K)	180M	SF-V5RUH18K	00620(22K)
22 kW	180M	SF-V5RU22K	01540(30K)	180M	SF-V5RUH22K	00770(30K)
30 kW	200L <sup>*2</sup>	SF-V5RU30K	01870(37K)	200L <sup>*2</sup>	SF-V5RUH30K	00930(37K)
37 kW	200L <sup>*2</sup>	SF-V5RU37K	02330(45K)	200L <sup>*2</sup>	SF-V5RUH37K	01160(45K)
45 kW	200L <sup>*2</sup>	SF-V5RU45K	03160(55K)	200L <sup>*2</sup>	SF-V5RUH45K	01800(55K)
55 kW	225S <sup>*1</sup>	SF-V5RU55K	03800(75K)	225S <sup>*1</sup>	SF-V5RUH55K	02160(75K)
75 kW	250MD	SF-THY	04750(90K)	250MD	SF-THY	02600(90K)
90 kW	—	—	—	250MD	SF-THY	03250(110K)
110 kW	—	—	—	280MD	SF-THY	03610(132K)
132 kW	—	—	—	280MD	SF-THY	04320(160K)
160 kW	—	—	—	280MD	SF-THY	04810(185K)
200 kW	—	—	—	280L	SF-THY	05470(220K)
250 kW	—	—	—	315H	SF-THY	06830(280K)

- Combination with the SF-V5RU1, 3, 4, and SF-THY (ND rating)

	SF-V5RU[]1 (1:2)			SF-V5RU[]3 (1:3)			SF-V5RU[]4 (1:4)		
Voltage	200 V class								
Rated speed	1000 r/min			1000 r/min			500 r/min		
Base frequency	33.33 Hz			33.33 Hz			16.6 Hz		
Maximum speed	2000 r/min			3000 r/min			2000 r/min		
Motor capacity	Motor frame No.	Motor model	Inverter model FR-A820-[]	Motor frame No.	Motor model	Inverter model FR-A820-[]	Motor frame No.	Motor model	Inverter model FR-A820-[]
1.5 kW	100L	SF-V5RU1K1(Y)	00167(2.2K)	112M	SF-V5RU1K3(Y)	00167(2.2K)	132M	SF-V5RU1K4(Y)	00167(2.2K)
2.2 kW	112M	SF-V5RU2K1(Y)	00250(3.7K)	132S	SF-V5RU2K3(Y)	00250(3.7K)	160M	SF-V5RU2K4(Y)	00250(3.7K)
3.7 kW	132S	SF-V5RU3K1(Y)	00340(5.5K)	132M	SF-V5RU3K3(Y)	00340(5.5K)	160L	SF-V5RU3K4	00490(7.5K) <sup>*4</sup>
5.5 kW	132M	SF-V5RU5K1(Y)	00490(7.5K)	160M	SF-V5RU5K3(Y)	00490(7.5K)	180L	SF-V5RU5K4 (Y)	00490(7.5K)
7.5 kW	160M	SF-V5RU7K1(Y)	00630(11K)	160L	SF-V5RU7K3(Y)	00630(11K)	200L	SF-V5RU7K4(Y)	00630(11K)
11 kW	160L	SF-V5RU11K1(Y)	00770(15K)	180M	SF-V5RU11K3(Y)	00770(15K)	225S	SF-V5RU11K4(Y)	00770(15K)
15 kW	180M	SF-V5RU15K1(Y)	00930(18.5K)	180L	SF-V5RU15K3(Y)	00930(18.5K)	225S	SF-V5RU15K4	01250(22K) <sup>*4</sup>
18.5 kW	180L	SF-V5RU18K1(Y)	01250(22K)	200L	SF-V5RU18K3(Y)	01250(22K)	250MD	SF-THY <sup>*5</sup>	01250(22K)
22 kW	200L	SF-V5RU22K1(Y)	01540(30K)	200L	SF-V5RU22K3(Y)	01540(30K)	280MD	SF-THY <sup>*5</sup>	01540(30K)
30 kW	200L <sup>*3</sup>	SF-V5RU30K1(Y)	01870(37K)	225S <sup>*1</sup>	SF-V5RU30K3(Y)	01870(37K)	280MD	SF-THY <sup>*5</sup>	01870(37K)
37 kW	225S	SF-V5RU37K1(Y)	02330(45K)	250MD <sup>*1</sup>	SF-THY <sup>*5</sup>	02330(45K)	280MD	SF-THY <sup>*5</sup>	02330(45K)
45 kW	250MD	SF-THY <sup>*5</sup>	03160(55K)	250MD <sup>*1</sup>	SF-THY <sup>*5</sup>	03160(55K)	280MD	SF-THY <sup>*5</sup>	03160(55K)
55 kW	250MD	SF-THY <sup>*5</sup>	03800(75K)	280MD <sup>*1</sup>	SF-THY <sup>*5</sup>	03800(75K)	280L	SF-THY <sup>*5</sup>	03800(75K)

400 V class are developed upon receipt of order.

\*1 The maximum speed is 2400 r/min.

\*2 80% output in the high-speed range. (The output is reduced when the speed is 2400 r/min or faster.)

\*3 90% output in the high-speed range. (The output is reduced when the speed is 1000 r/min or faster.)

\*4 For motors with overload capacity 150% 60 seconds ("Y" at the end of their model names), contact your sales representative.

\*5 This model is developed upon receipt of order.

# 2.10 Connection of stand-alone option units

The inverter accepts a variety of stand-alone option units as required.

Incorrect connection will cause inverter damage or accident. Connect and operate the option unit carefully in accordance with the Instruction Manual of the corresponding option unit.

## 2.10.1 Connection of the brake resistor

- When an inverter-driven motor is driven by a load or requires rapid deceleration, install an external brake resistor. Connect the brake resistor to terminals P/(P3) and PR. (For the locations of terminal P/(P3) and PR, refer to the terminal block layout (page 55).)
- For the FR-A820-00490(7.5K) or lower and the FR-A840-00250(7.5K) or lower, the plug-in brake resistor is connected to terminals P/+ and PX.

When the plug-in brake resistor does not have enough thermal capability for high-duty operation, install an external brake resistor. At this time, remove the jumper across terminals PR and PX and connect the brake resistor to terminals P/+ and PR. terminal block layout (page 55).)

Removing jumpers across terminals PR and PX disables the plug-in brake resistor (power is not supplied). The plug-in brake resistor can be left connected to the inverter, and so is the plug-in brake resistor's lead wire connected to the terminal.

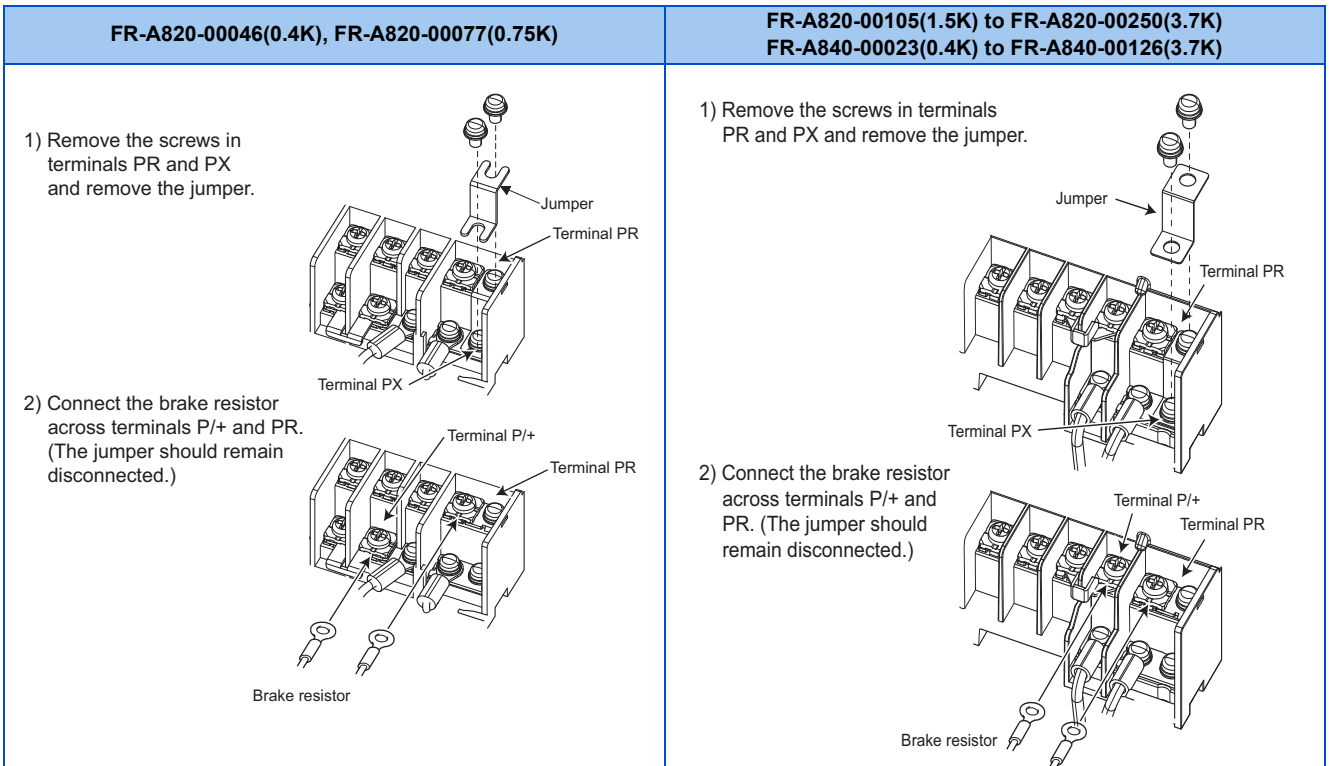

**FR-A820-00340(5.5K), FR-A820-00490(7.5K), FR-A840-00170(5.5K), FR-A840-00250(7.5K)**

1) Remove the screws in terminals PR and PX and remove the jumper.

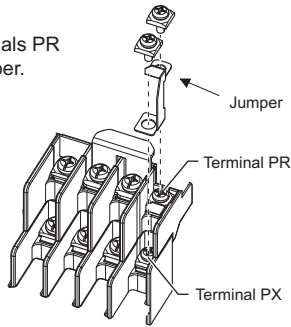

2) Connect the brake resistor across terminals P/+ and PR. (The jumper should remain disconnected.)

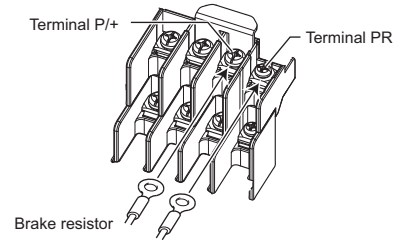

**FR-A820-00630(11K), FR-A840-00310(11K), FR-A840-00380(15K)**

Connect the brake resistor across terminals P/+ and PR.

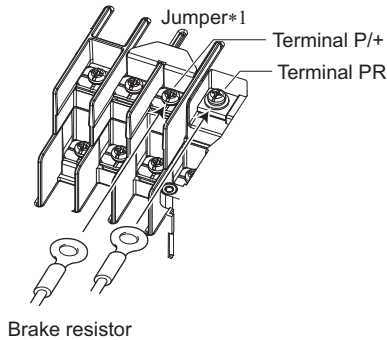

**FR-A820-00770(15K) to FR-A820-01250(22K), FR-A840-00470(18.5K), FR-A840-00620(22K)**

Connect the brake resistor across terminals P3 and PR.

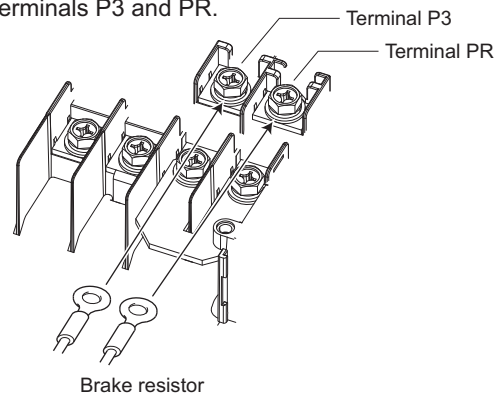

**FR-A840-00770(30K)**

Connect the brake resistor across terminals P3 and PR.

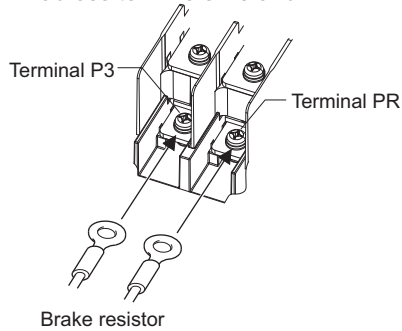

**FR-A840-00930(37K) to FR-A840-01800(55K)**

Connect the brake resistor across terminals P3 and PR.

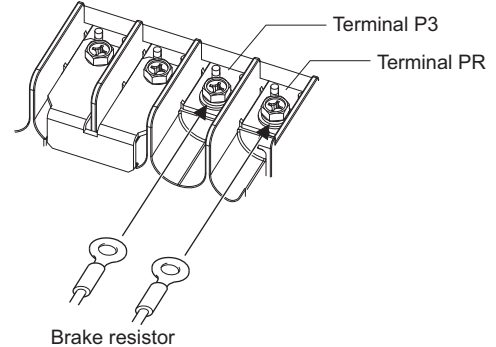

\*1 Do not remove the jumper across terminals P/+ and P1 except when connecting a DC reactor (FR-HEL).

**NOTE**

- For the FR-A820-00490(7.5K) or lower and the FR-A840-00250(7.5K) or lower, the jumper across terminals PR and PX must be disconnected before connecting the dedicated brake resistor. Doing so may damage the inverter.
- A brake resistor cannot be used with options such as brake units, high power factor converters, and power regeneration converters.

**◆ Connection of the dedicated external brake resistor (FR-ABR)**

The FR-ABR can be applied to the FR-A820-01250(22K) or lower and the FR-A840-00620(22K) or lower.

Set parameters as follows:

- **Pr.30 Regenerative function selection = "1"**



- **Pr.70 Special regenerative brake duty** = 10% (for 7.5K or lower) or 6% (for 11K or higher)  
(Refer to [page 724.](#))

- When the regenerative brake transistor is damaged, the following sequence is recommended to prevent overheat and burnout of the brake resistor.

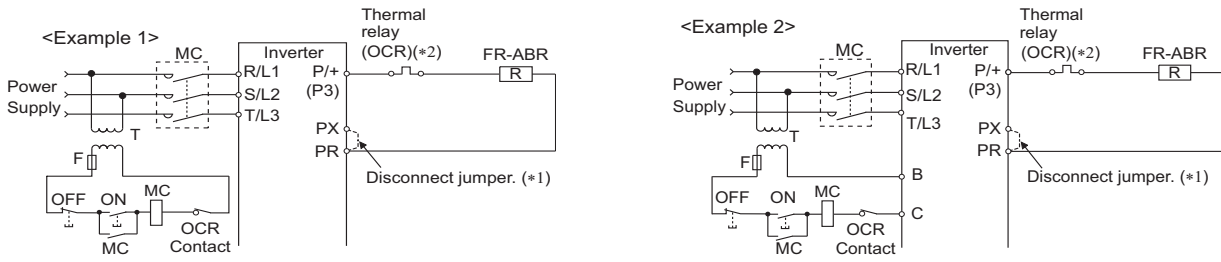

\*1 Since the FR-A820-00630(11K) or higher and FR-A840-00310(11K) or higher are not provided with terminal PX, a jumper need not to be removed.  
 \*2 Refer to the following table for the thermal relay models for each capacity. Refer to the following diagram for the connection. (Always install a thermal relay when using a brake resistor for the inverters with 11K or higher capacity.)

Power supply voltage	High-duty brake resistor	Thermal relay model (Mitsubishi electric product)	Rated operating current
200 V	FR-ABR-0.4K	TH-T25-0.7A	120 VAC: 2 A (NO contact) / 3 A (NC contact), 240 VAC: 1 A (NO contact) / 2 A (NC contact) (AC15 class) 110 VDC: 0.2 A, 220 VDC: 0.1 A (DC13 class)
	FR-ABR-0.75K	TH-T25-1.3A	
	FR-ABR-2.2K	TH-T25-2.1A	
	FR-ABR-3.7K	TH-T25-3.6A	
	FR-ABR-5.5K	TH-T25-5A	
	FR-ABR-7.5K	TH-T25-6.6A	
	FR-ABR-11K	TH-T25-11A	
	FR-ABR-15K	TH-T25-11A	
	FR-ABR-22K	TH-T65-22A	
400 V	FR-ABR-H0.4K	TH-T25-0.24A	
	FR-ABR-H0.75K	TH-T25-0.35A	
	FR-ABR-H1.5K	TH-T25-0.9A	
	FR-ABR-H2.2K	TH-T25-1.3A	
	FR-ABR-H3.7K	TH-T25-2.1A	
	FR-ABR-H5.5K	TH-T25-2.5A	
	FR-ABR-H7.5K	TH-T25-3.6A	
	FR-ABR-H11K	TH-T25-6.6A	
	FR-ABR-H15K	TH-T25-6.6A	
	FR-ABR-H22K	TH-T25-9A	

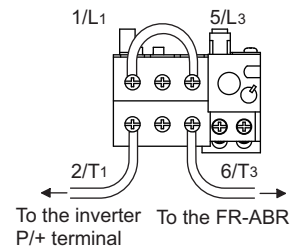

### ◆ Connection of a brake resistor other than the FR-ABR

A brake resistor can be used with the FR-A820-01250(22K) or lower and the FR-A840-01800(55K) or lower.

Use a brake resistor that has resistance and power consumption values higher than the following. Also, the brake resistor must have a sufficient capacity to consume the regenerative power.

Voltage class	Inverter	Minimum resistance (Ω)	Power consumption (kW)
200 V class	FR-A820-00046(0.4K)	100	1.44
	FR-A820-00077(0.75K)	80	1.81
	FR-A820-00105(1.5K)	50	2.89
	FR-A820-00167(2.2K)	33	4.38
	FR-A820-00250(3.7K)	30	4.81
	FR-A820-00340(5.5K)	18	8.02
	FR-A820-00490(7.5K)	18	8.02
	FR-A820-00630(11K)	12	12.0
	FR-A820-00770(15K)	8.5	17.0
	FR-A820-00930(18.5K)	6.5	22.2
	FR-A820-01250(22K)	6.5	22.2



Voltage class	Inverter	Minimum resistance ( $\Omega$ )	Power consumption (kW) <sup>*1</sup>	
			Pr.977 = "0"	Pr.977 = "1"
400 V class	FR-A840-00023(0.4K)	371	1.56	1.66
	FR-A840-00038(0.75K)	236	2.45	2.61
	FR-A840-00052(1.5K)	190	3.04	3.24
	FR-A840-00083(2.2K)	130	4.44	4.74
	FR-A840-00126(3.7K)	83	6.96	7.42
	FR-A840-00170(5.5K)	66	8.75	9.34
	FR-A840-00250(7.5K)	45	12.8	13.7
	FR-A840-00310(11K)	34	17.0	18.1
	FR-A840-00380(15K)	34	17.0	18.1
	FR-A840-00470(18.5K)	21	27.5	29.3
	FR-A840-00620(22K)	21	27.5	29.3
	FR-A840-00770(30K)	13.5	42.8	45.6
	FR-A840-00930(37K)	13.5	42.8	45.6
	FR-A840-01160(45K)	13.5	42.8	45.6
	FR-A840-01800(55K)	13.5	42.8	45.6

\*1 Power consumption differs according to the voltage protection level. The voltage protection level is set in Pr.977. (Refer to page 345.)

Set parameters as follows:

- **Pr.30 Regenerative function selection = "1"**
- Set **Pr.70 Special regenerative brake duty** according to the amount and frequency of the regenerative driving, and make sure that the resistor can consume the regenerative power properly. (Refer to page 724.)
- When the regenerative brake transistor is damaged, install a thermal relay as shown in the following sequence to prevent overheat and burnout of the brake resistor. Properly select a thermal relay according to the regenerative driving frequency or the rated power or resistance of the brake resistor.

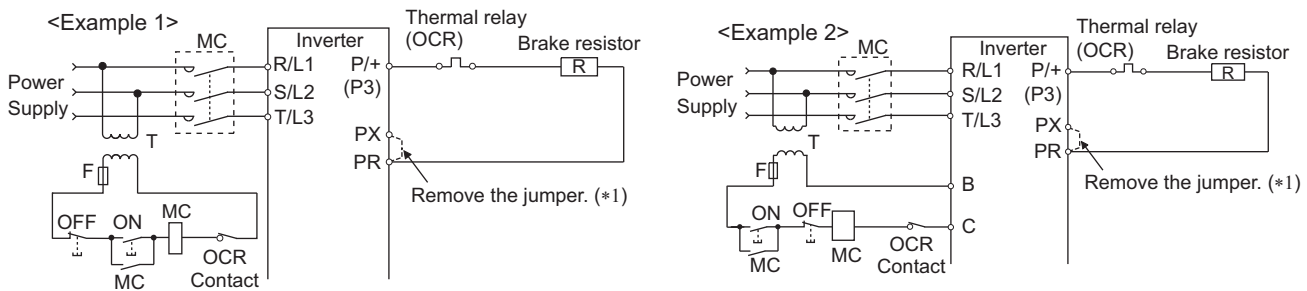

\*1 Since the FR-A820-00630(11K) or higher and FR-A840-00310(11K) or higher are not provided with terminal PX, a jumper need not to be removed.

## CAUTION

- If the resistor selection is incorrect, overcurrent may damage the inverter built-in brake transistor. Besides, the resistor may be burned due to overheat.
- If the selection of the thermal relay is incorrect, the resistor may be burned due to overheat.

## 2.10.2 Connection of the brake unit (FR-BU2)

Connect the brake unit (FR-BU2(-H)) as follows to improve the braking capability during deceleration.

## ◆ Connection example with the GRZG type discharging resistor

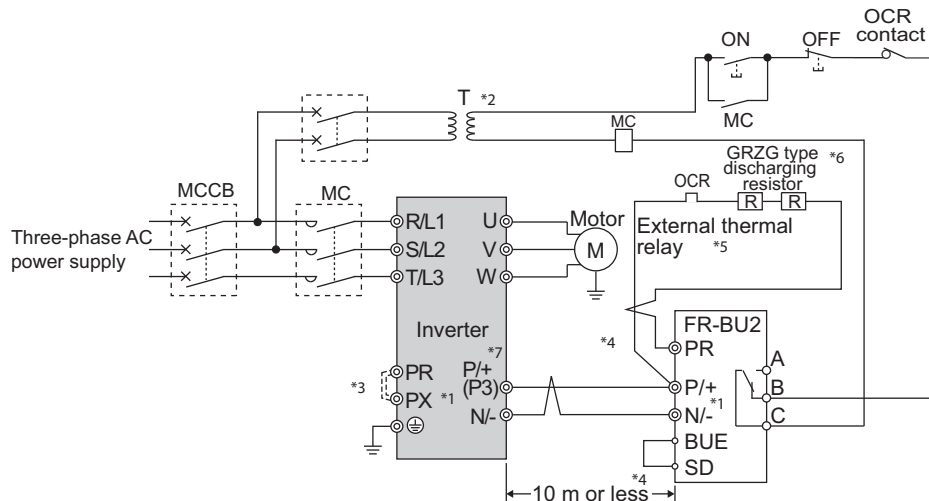

- \*1 When wiring, make sure to match the terminal symbols (P/+, N/-) on the inverter and on the brake unit. (Incorrect connection will damage the inverter and brake unit.)
- \*2 When the power supply is 400 V class, install a stepdown transformer.
- \*3 Be sure to remove the jumper across terminals PR and PX when using the FR-BU2 with the inverter of FR-A820-00490(7.5K) or lower, or FR-A840-00250(7.5K) or lower.
- \*4 The wiring distance between the inverter, brake unit (FR-BU2) and discharging resistor must be within 5 m. When using twisted pair cable, use the cable within 10 m.
- \*5 It is recommended to install an external thermal relay to prevent overheat of the discharging resistor.
- \*6 For the connection method of the discharging resistor, refer to the Instruction Manual of the FR-BU2.
- \*7 Terminal P3 is equipped in the FR-A820-00770(15K) to 01250(22K), and FR-A840-00470(18.5K) to 01800(55K). Terminal P3 has the same function as terminal P/+ on the inverter.

• Recommended external thermal relay

brake unit	Discharging resistor	Recommended external thermal relay
FR-BU2-1.5K	GZG 300W-50Ω (one)	TH-T25 1.3A
FR-BU2-3.7K	GRZG 200-10Ω (three in series)	TH-T25 3.6A
FR-BU2-7.5K	GRZG 300-5Ω (four in series)	TH-T25 6.6A
FR-BU2-15K	GRZG 400-2Ω (six in series)	TH-T25 11A
FR-BU2-H7.5K	GRZG 200-10Ω (six in series)	TH-T25 3.6A
FR-BU2-H15K	GRZG 300-5Ω (eight in series)	TH-T25 6.6A
FR-BU2-H30K	GRZG 400-2Ω (twelve in series)	TH-T25 11A

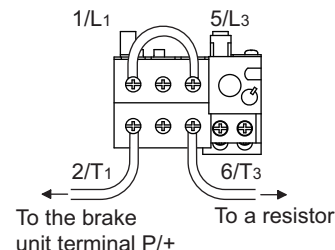

**NOTE**

- Set "1" in **Pr.0 Brake mode selection** in the FR-BU2 to use a GRZG type discharging resistor.
- Do not remove the jumper across terminals P/+ and P1 except when connecting a DC reactor (FR-HEL).

## ◆ Connection example with the FR-BR(-H) resistor unit

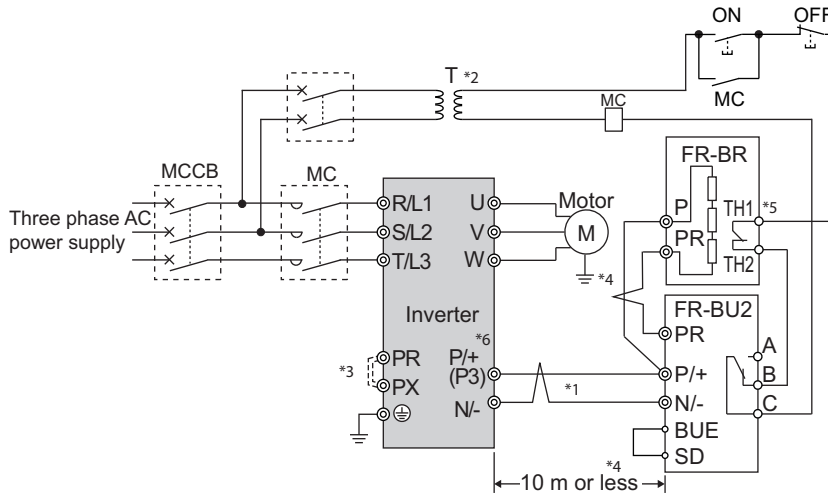

- \*1 When wiring, make sure to match the terminal symbols (P/+, N/-) on the inverter and on the brake unit (FR-BU2). (Incorrect connection will damage the inverter and brake unit.)
- \*2 When the power supply is 400 V class, install a stepdown transformer.
- \*3 Be sure to remove the jumper across terminals PR and PX when using the FR-BU2 with the inverter of FR-A820-00490(7.5K) or lower, or FR-A840-00250(7.5K) or lower.
- \*4 The wiring distance between the inverter, brake unit (FR-BU2) and resistor unit (FR-BR) must be within 5 m. When using twisted pair cable, use the cable within 10 m.
- \*5 The contact between TH1 and TH2 is closed in the normal status and is open at a fault.
- \*6 Terminal P3 is equipped in the FR-A820-00770(15K) to 01250(22K), and FR-A840-00470(18.5K) to 01800(55K). Terminal P3 has the same function as terminal P/+ on the inverter.

### NOTE

- Do not remove the jumper across terminals P/+ and P1 except when connecting a DC reactor (FR-HEL).

## ◆ Connection example with the MT-BR5 type resistor unit

After making sure that the wiring is correct and secure, set **Pr.30 Regenerative function selection** = "1" and **Pr.70 Special regenerative brake duty** = "0 (initial value)". Set **Pr.0 Brake mode selection** = "2" in the brake unit FR-BU2.

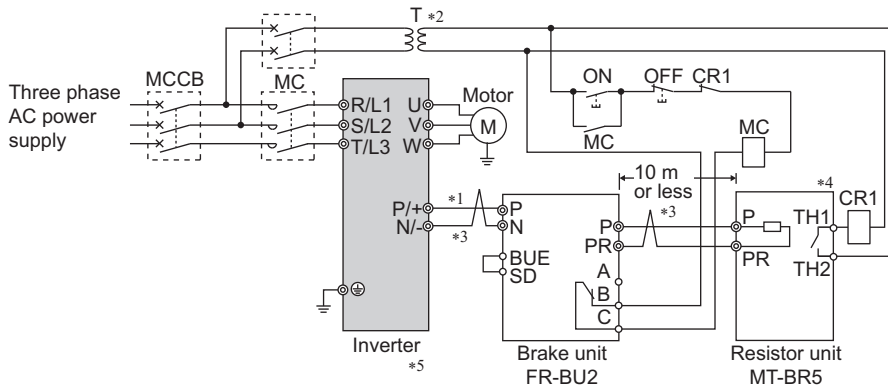

- \*1 When wiring, make sure to match the terminal symbols (P/+, N/-) on the inverter and on the brake unit (FR-BU2). (Incorrect connection will damage the inverter and brake unit.)
- \*2 When the power supply is 400 V class, install a stepdown transformer.
- \*3 The wiring distance between the inverter, brake unit (FR-BU2) and resistor unit (FR-BR) must be within 5 m. When using twisted pair cable, use the cable within 10 m.
- \*4 The contact between TH1 and TH2 is open in the normal status and is closed at a fault.
- \*5 The CN8 connector used with the MT-BU5 type brake unit is not used.

### NOTE

- The warning "oL" of the stall prevention (overvoltage) does not occur while **Pr.30 Regenerative function selection** = "1" and **Pr.70 Special regenerative brake duty** = 0% (initial value). (Refer to [page 724.](#))

## 2.10.3 Connection of the brake unit (FR-BU)

Connect the brake unit (FR-BU(-H)) as follows to improve the braking capability during deceleration.

The FR-BU is compatible with the FR-A820-03160(55K) or lower and the FR-A840-01800(55K) or lower.

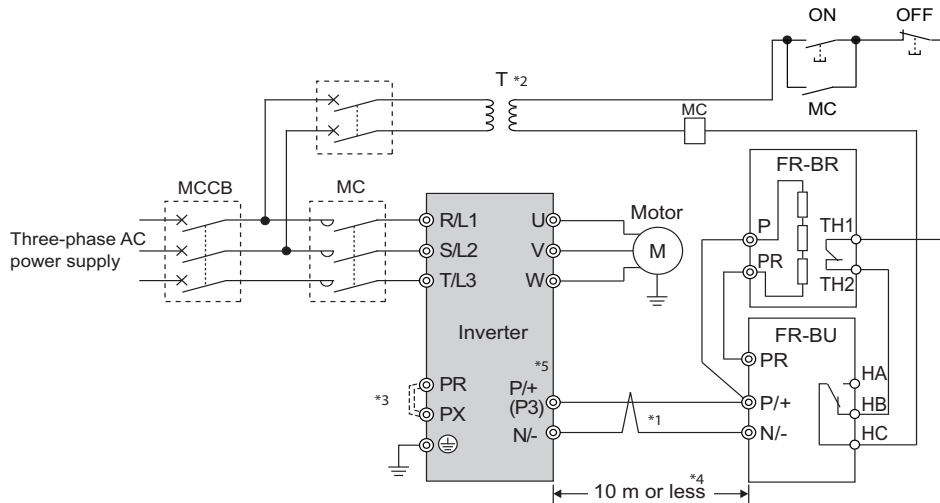

- \*1 When wiring, make sure to match the terminal symbols (P/+, N/-) on the inverter and on the brake unit (FR-BU(-H)). (Incorrect connection will damage the inverter.)
- \*2 When the power supply is 400 V class, install a stepdown transformer.
- \*3 For the FR-A820-00490(7.5K) or lower and FR-A840-00250(7.5K) or lower, be sure to remove the jumper across terminals PR and PX.
- \*4 The wiring distance between the inverter, brake unit (FR-BU) and resistor unit (FR-BR) must be within 5 m. When using twisted pair cable, use the cable within 10 m.
- \*5 Terminal P3 is equipped in the FR-A820-00770(15K) to 01250(22K), and FR-A840-00470(18.5K) to 01800(55K). Terminal P3 has the same function as terminal P/+ on the inverter.

### NOTE

- If the transistors in the brake unit should become faulty, the resistor will overheat. Install a magnetic contactor on the inverter's input side and configure a circuit that shut off the current in case of a fault.
- Do not remove the jumper across terminals P/+ and P1 except when connecting a DC reactor (FR-HEL).

## 2.10.4 Connection of the brake unit (BU type)

Connect the brake unit (BU type) correctly as follows. Incorrect connection will damage the inverter. Remove the jumpers across terminals HB and PC and terminals TB and HC on the brake unit, and fit one across terminals PC and TB. The BU type brake unit is compatible with the FR-A820-03160(55K) or lower and the FR-A840-01800(55K) and lower.

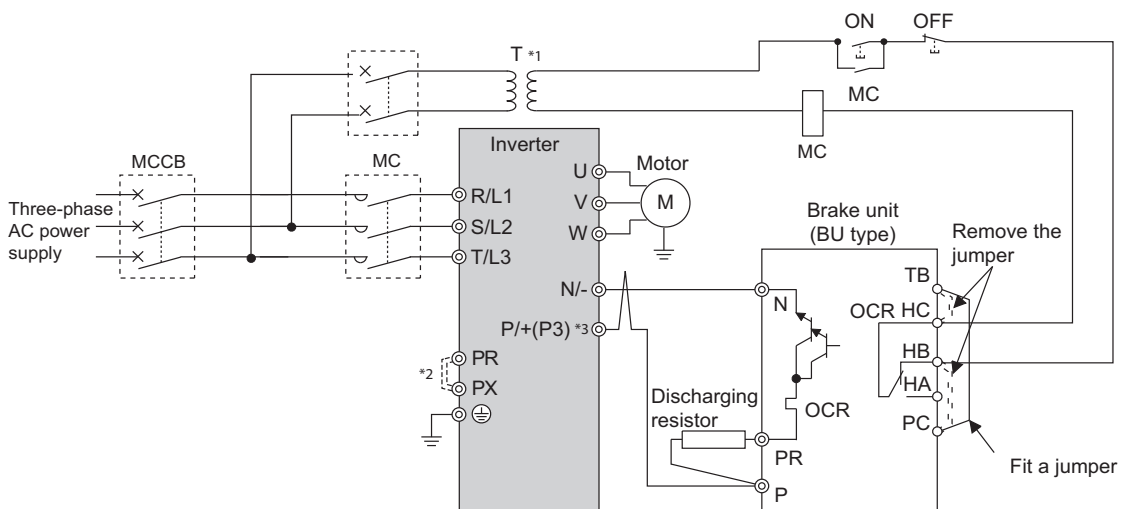

- \*1 When the power supply is 400 V class, install a stepdown transformer.
- \*2 For the FR-A820-00490(7.5K) or lower and FR-A840-00250(7.5K) or lower, be sure to remove the jumper across terminals PR and PX.
- \*3 Terminal P3 is equipped in the FR-A820-00770(15K) to 01250(22K), and FR-A840-00470(18.5K) to 01800(55K). Terminal P3 has the same function as terminal P/+ on the inverter.

## NOTE

- The wiring distance between the inverter, brake unit, and discharging resistor must be within 2 m. Even when the cable is twisted, the wiring length must be within 5 m.
- If the transistors in the brake unit should become faulty, the resistor will overheat and result in a fire. Install a magnetic contactor on the inverter's input side and configure a circuit that shut off the current in case of a fault.
- Do not remove the jumper across terminals P/+ and P1 except when connecting a DC reactor (FR-HEL).

## 2.10.5 Connection of the high power factor converter (FR-HC2)

When connecting the high power factor converter (FR-HC2) to suppress power harmonics, perform wiring securely as follows. Incorrect connection will damage the high power factor converter and the inverter.

After making sure that the wiring is correct and secure, set the rated motor voltage in **Pr.19 Base frequency voltage** (under V/F control) or **Pr.83 Rated motor voltage** (under other than V/F control) and "2 or 102" in **Pr.30 Regenerative function selection**. (Refer to [page 724](#).)

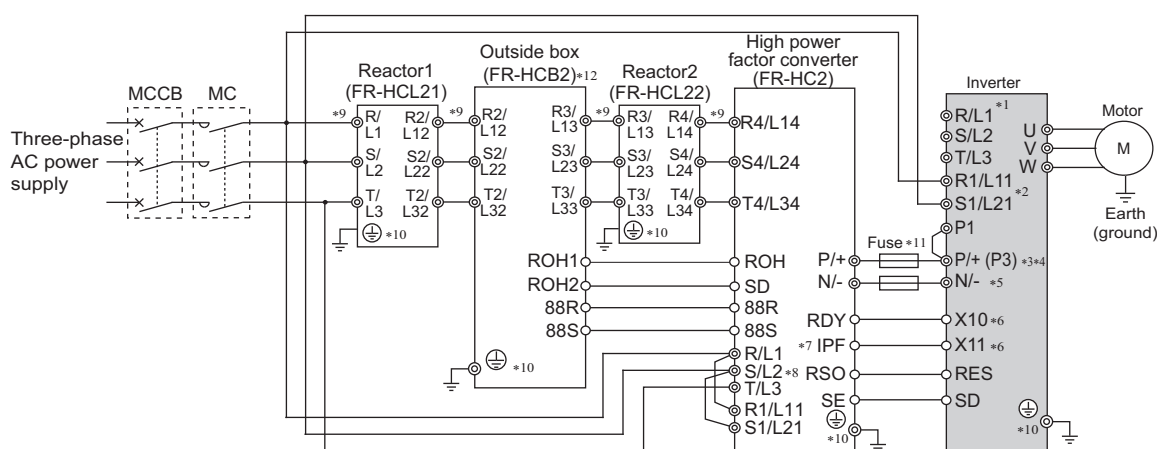

- \*1 Remove jumpers across terminals R/L1 and R1/L11 as well as across terminals S/L2 and S1/L21, and connect the power supply for the control circuit to terminals R1/L11 and S1/L21. Do not connect anything to power input terminals (R/L1, S/L2, and T/L3). Incorrect connection will damage the inverter. (The E.OPT fault (Option fault) occurs. (Refer to [page 791](#).)
- \*2 Instead of connecting the terminals to the AC power supply, the control circuit can be powered by connecting terminal R1/L11 to terminal P/+ (P3) and terminal S1/L21 to terminal N/-. In this case, do not connect the terminals to the AC power supply. Doing so will damage the inverter.
- \*3 Terminal P3 is equipped in the FR-A820-00770(15K) to 01250(22K), and FR-A840-00470(18.5K) to 01800(55K). When connecting multiple inverters in parallel, always use either terminal P/+ or P3 for the connection. (Do not use terminals P/+ and P3 together.)
- \*4 When the FR-HC2 is connected, the jumper across terminals P/+ and P1 does not affect the function. (The FR-HC2 can be connected with the jumper connected (initial setting). Refer to [page 55](#) for the jumper connection status in the initial setting.)
- \*5 Do not install an MCCB across terminals P/+ and N/- (between terminals P and P/+ or between terminals N and N/-). Connecting the opposite polarity of terminals N/- and P/+ will damage the inverter.
- \*6 Use **Pr.178 to Pr.189 (Input terminal function selection)** to assign the terminals used for the X10 (X11) signal. (Refer to [page 521](#).) For RS-485 or any other communication where the start command is only transmitted once, use the X11 signal to save the operation mode at the time of an instantaneous power failure.
- \*7 Assign the IPF signal to a terminal on the FR-HC2. (Refer to the Instruction Manual of the FR-HC2.)
- \*8 Always connect terminals R/L1, S/L2, and T/L3 on the FR-HC2 to the power supply. Operating the inverter without connecting them will damage the FR-HC2.
- \*9 Do not install an MCCB or MC across terminals (R/L1, S/L2, T/L3) on the reactor 1 and terminals (R4/L14, S4/L24, T4/L34) on the FR-HC2. Doing so disrupts proper operation.
- \*10 Securely perform grounding (earthing) by using the grounding (earthing) terminal.
- \*11 Installation of a fuse is recommended. (Refer to the Instruction Manual of the FR-HC2.)
- \*12 Outside box is not available for the FR-HC2-H280K or higher. Connect filter capacitors, inrush current limit resistors, and magnetic contactors. (Refer to the Instruction Manual of the FR-HC2.)

**NOTE**

- The voltage phases of terminals R/L1, S/L2, and T/L3 and the voltage phases of terminals R4/L14, S4/L24, and T4/L34 must be matched.
- The control logic (sink logic/source logic) of the high power factor converter and the inverter must be matched. (Refer to [page 72](#).)
- Do not connect a DC reactor (FR-HEL) to the inverter when the FR-HC2 is connected.

**CAUTION**

- Always connect terminal RDY on the FR-HC2 to a terminal where the X10 signal or MRS signal is assigned on the inverter. Always connect terminal SE on the FR-HC2 to terminal SD on the inverter. Not connecting these terminals may damage the FR-HC2.

## 2.10.6 Connection of the multifunction regeneration converter (FR-XC)

### ◆ Common bus regeneration mode with harmonic suppression disabled (Pr.416 = "0")

When connecting the multifunction regeneration converter (FR-XC) to improve the braking capability, perform wiring securely as follows. Failure to do so will damage the converter and the inverter.

Turn ON switch 1 (connection mode setting switch) in the function selection switch assembly (SW2). If the switch setting does not match the actual wiring, the connection mode fault "E.T" occurs.

After making sure that the wiring is correct and secure, set "2 or 102" in **Pr.30 Regenerative function selection**. (Refer to [page 724](#).)

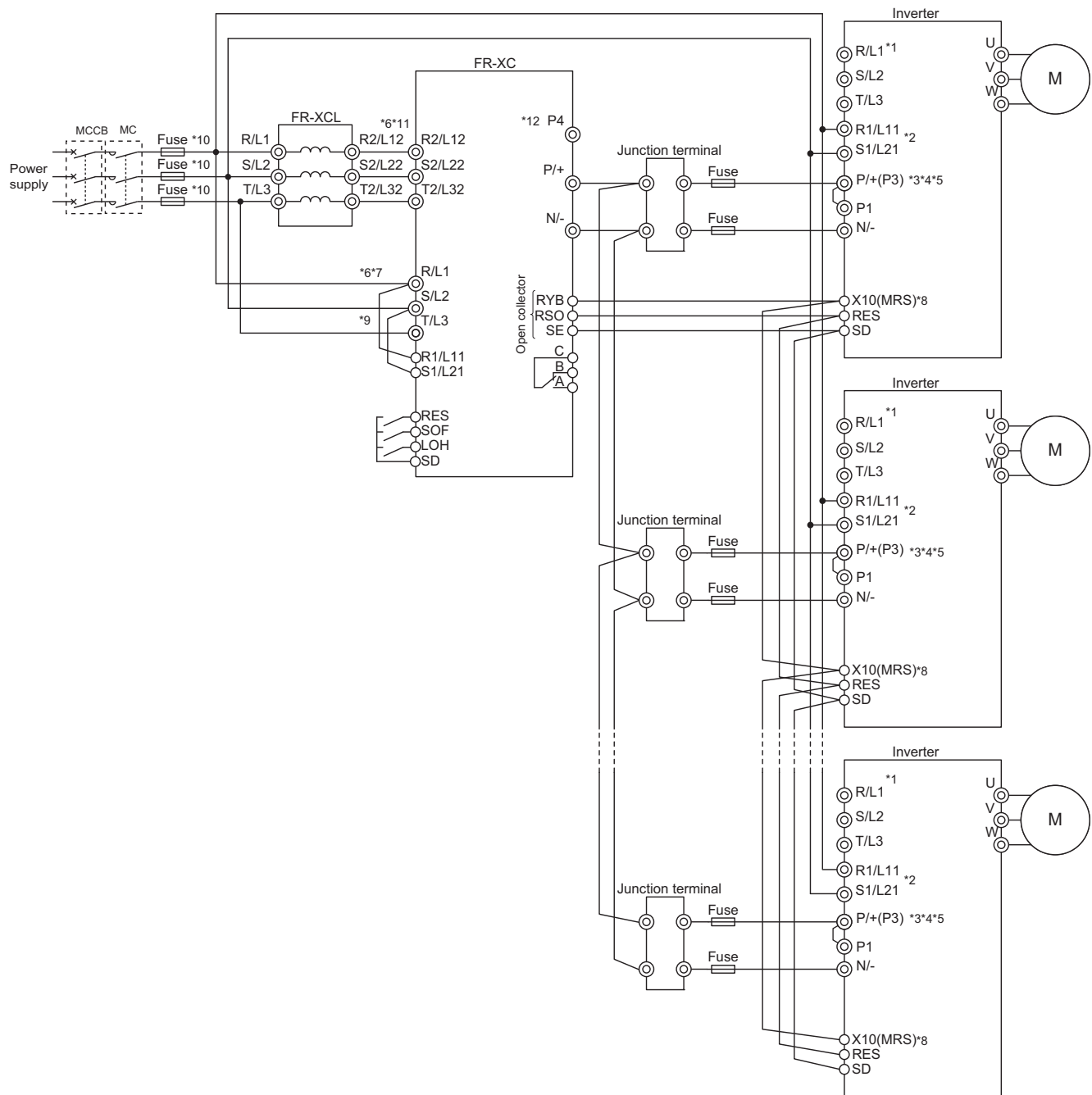

- \*1 Never connect the power supply to terminals R/L1, S/L2, and T/L3 on the inverter. Doing so will damage the inverter and the converter.
- \*2 Instead of connecting the terminals to the AC power supply, the control circuit can be powered by connecting terminal R1/L11 to terminal P/+ (P3) and terminal S1/L21 to terminal N/-. In this case, do not connect the terminals to the AC power supply. Doing so will damage the inverter.
- \*3 Terminal P3 is equipped in the FR-A820-00770(15K) to 01250(22K), and FR-A840-00470(18.5K) to 01800(55K). When connecting multiple inverters in parallel, always use either terminal P/+ or P3 for the connection. (Do not use terminals P/+ and P3 together.)
- \*4 When the FR-XC is connected, the jumper across terminals P/+ and P1 does not affect the function. (The FR-XC can be connected with the jumper connected.) Refer to [page 55](#) for the jumper connection status in the initial setting.)
- \*5 Connect between the inverter terminal P/+ and the converter terminal P/+ and between the inverter terminal N/- and the converter terminal N/- for polarity consistency.  
Connecting opposite polarity of terminals P/+ and N/- will damage the converter and the inverter.
- \*6 Confirm the correct phase sequence of three-phase current to connect between the reactor and the converter, and between the power supply and terminals R/L1, S/L2, and T/L3.  
Incorrect connection will damage the converter.
- \*7 Be sure to connect the power supply and terminals R/L1, S/L2, and T/L3 of the converter. Operating the inverter without connecting them will damage the converter.
- \*8 Assign the X10 signal to any of the input terminals.
- \*9 To use separate power supply for the control circuit, remove each jumper at terminal R1/L11 and terminal S1/L21.
- \*10 Install UL listed fuses on the input side of the reactor to meet the UL/cUL standards (refer to the FR-XC Instruction Manual for information about the fuse).

- \*11 Do not install an MCCB or MC between the reactor and the converter. Doing so disrupts proper operation.
- \*12 Do not connect anything to terminal P4.

## CAUTION

- In the common bus regeneration mode, always connect between the converter terminal RYB and the inverter terminal to which the X10 (MRS) signal is assigned and between the converter terminal SE and the inverter terminal SD. If the terminals are not connected, the converter may be damaged.

## NOTE

- The control logic (sink logic/source logic) of the converter and the inverter must be matched. The converter does not operate properly if the control logic is not consistent with each other.  
(Refer to [page 72](#) for the switching of the control logic. Refer to the FR-XC Instruction Manual for the switching of the control logic of the converter.)
- Keep the wiring length between terminals as short as possible.
- When the power is distorted or falls off sharply, the reactors may generate abnormal acoustic noise. This acoustic noise is caused by the power supply fault and not by the damage of the converter.
- Configure a system so that the magnetic contactor at the converter input side shuts off the power supply at a failure of the converter or the connected inverter. (The converter does not shut off the power supply by itself.) Failure to do so may overheat and burn the resistors in the converter and the connected inverter.
- Do not connect a DC reactor to the inverter when using the converter in the common bus regeneration mode.
- For details on model selection and connection, refer to the FR-XC Instruction Manual.
- For details on connection in common bus regeneration mode with harmonic suppression enabled or in power regeneration mode 2, refer to the FR-XC Instruction Manual.

## 2.10.7 Connection of the power regeneration common converter (FR-CV)

When wiring for connecting the power regeneration common converter (FR-CV) to the inverter, make sure to match the terminal symbols (P/+, N/-) on the inverter and on the power regeneration common converter.

The FR-CV is compatible with the FR-A820-03160(55K) or lower and the FR-A840-01800(55K) or lower.

After making sure that the wiring is correct and secure, set "2 or 102" in **Pr.30 Regenerative function selection**. (Refer to [page 724](#).)

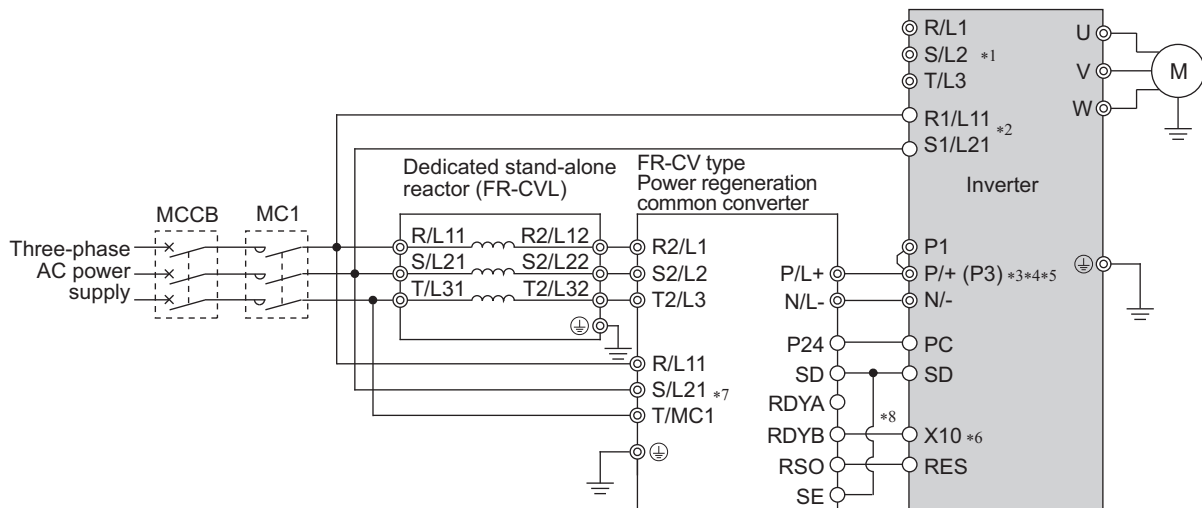

- \*1 Remove jumpers across terminals R/L1 and R1/L11 as well as across terminals S/L2 and S1/L21, and connect the power supply for the control circuit to terminals R1/L11 and S1/L21. Do not connect anything to power input terminals (R/L1, S/L2, and T/L3). Incorrect connection will damage the inverter. (The E.OPT fault (Option fault) occurs. (Refer to [page 791](#).)
- \*2 Instead of connecting the terminals to the AC power supply, the control circuit can be powered by connecting terminal R1/L11 to terminal P/+ (P3) and terminal S1/L21 to terminal N/-. In this case, do not connect the terminals to the AC power supply. Doing so will damage the inverter.
- \*3 Terminal P3 is equipped in the FR-A820-00770(15K) to 01250(22K), and FR-A840-00470(18.5K) to 01800(55K). When connecting multiple inverters in parallel, always use either terminal P/+ or P3 for the connection. (Do not use terminals P/+ and P3 together.)
- \*4 When the FR-CV is connected, the jumper across terminals P/+ and P1 does not affect the function. (The FR-CV can be connected with the jumper connected.)
- \*5 Do not install an MCCB across terminals P/+ and N/- (between terminals P/L+ and P/+ or between N/L- and N/-). Connecting the opposite polarity of terminals N/- and P/+ will damage the inverter.



- \*6 Use **Pr.178 to Pr.189 (Input terminal function selection)** to assign the terminals used for the X10 signal. (Refer to [page 521.](#))
- \*7 Be sure to connect the power supply and terminals R/L11, S/L21, and T/MC1. Operating the inverter without connecting them will damage the power regeneration common converter.
- \*8 Always connect terminal RDY on the FR-HC2 to a terminal where the X10 signal or MRS signal is assigned on the inverter. Always connect terminal SE on the FR-HC2 to terminal SD on the inverter. Not connecting these terminals may damage the FR-CV.

**NOTE**

- The voltage phases of terminals R/L11, S/L21, and T/MC1 and the voltage phases of terminals R2/L1, S2/L2, and T2/L3 must be matched.
- Use the sink logic when the FR-CV is connected. It cannot be connected when the source logic is selected.
- Do not connect a DC reactor (FR-HEL) to the inverter when the FR-CV is connected.

## 2.10.8 Connection of the power regeneration converter (MT-RC)

When connecting the power regeneration converter (MT-RC), perform wiring securely as follows. Incorrect connection will damage the power regeneration converter and the inverter. The MT-RC is compatible with FR-A840-02160(75K) or higher. After making sure that the wiring is correct and secure, set "1" in **Pr.30 Regenerative function selection** and "0" in **Pr.70 Special regenerative brake duty**.

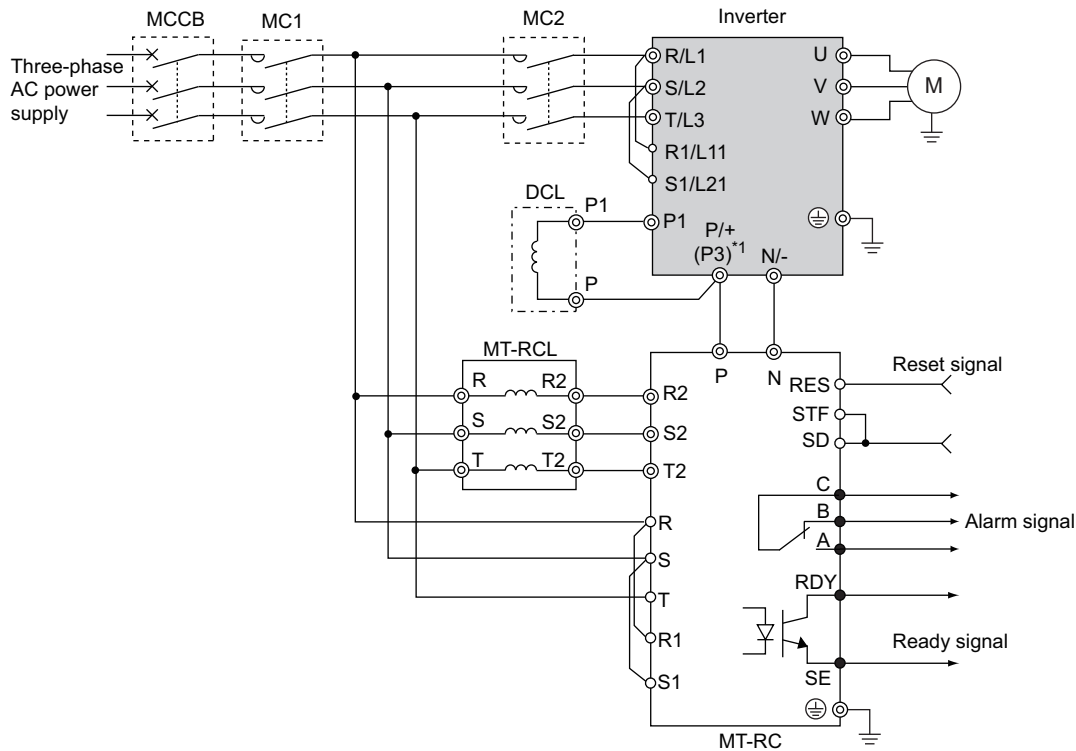

\*1 Terminal P3 is equipped in the FR-A820-00770(15K) to 01250(22K), and FR-A840-00470(18.5K) to 01800(55K). Terminal P3 has the same function as terminal P/+ on the inverter.

**NOTE**

- When using the inverter with the MT-RC, install a magnetic contactor (MC) at the input side of the inverter so that power is supplied to the inverter after one second or more has elapsed after powering ON the MT-RC. When power is supplied to the inverter prior to the MT-RC, the inverter and the MT-RC may be damaged or the MCCB may be shut off or damaged.

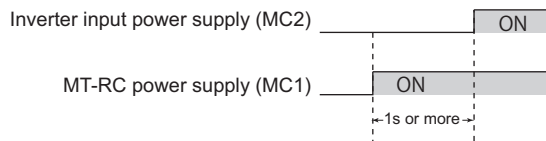

- When connecting the power coordination reactor and others, refer to Instruction Manual of the MT-RC for precautions.

## 2.10.9 Connection of the DC reactor (FR-HEL)

- Keep the surrounding air temperature within the permissible range (-10 to +50°C). Keep enough clearance around the reactor because it heats up. (Take 10 cm or more clearance on top and bottom and 5 cm or more on left and right regardless of the installation direction.)

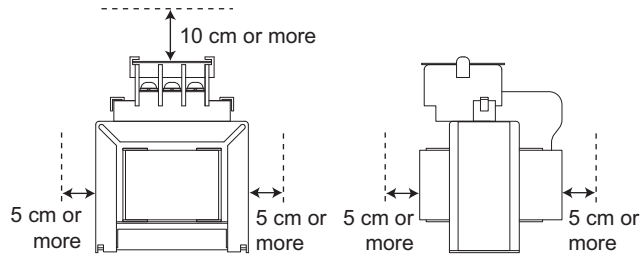

- When using the DC reactor (FR-HEL), connect it to terminals P/+ and P1. In this case, the jumper connected across terminals P/+ and P1 must be removed. Otherwise, the reactor will not be effective. (The jumper is not installed for the FR-A820-03800(75K) or higher and the FR-A840-02160(75K) or higher.)

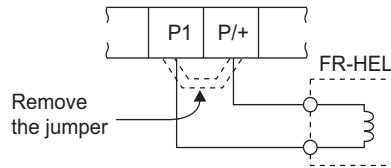

- Select a DC reactor according to the applied motor capacity (refer to [page 826](#)). For the FR-A820-03800(75K) or higher, the FR-A840-02160(75K) or higher, and when a 75 kW or higher motor is used, always connect a DC reactor.
- Since the DC reactor (FR-HEL) is electrically connected to the enclosure through mounting screws, the DC reactor is earthed (grounded) by being securely mounted to the enclosure. However, if the DC reactor is not earthed (grounded) securely enough, an earthing (grounding) cable may be used.

When using an earthing (grounding) cable for the FR-HEL-(H)55K or lower, wire the cable to the installation hole where varnish is removed. (Refer to the Instruction Manual of the FR-HEL.)

For the FR-HEL-(H)75K or higher, use an earth (ground) terminal to perform earthing (grounding). (Refer to the Instruction Manual of the FR-HEL.)

### NOTE

- The wiring distance must be within 5 m.
- As a reference, the cable gauge for the connection must be equal to or larger than that of the power cables (R/L1, S/L2, T/L3) and the earthing (grounding) cable. (Refer to [page 57](#).)

# 2.11 Wiring for use of the CC-Link IE Field Network (FR-A800-GF)

## 2.11.1 System configuration example

- Mount the "RJ71EN71", "RJ71GF11-T2", "QJ71GF11-T2", or "LJ71GF11-T2" type CC-Link IE Field Network master/local module on the main or extension base unit having the programmable controller CPU used as the master station.
- Connect the CC-Link IE Field Network programmable controller (master station) to the inverter with an Ethernet cable.

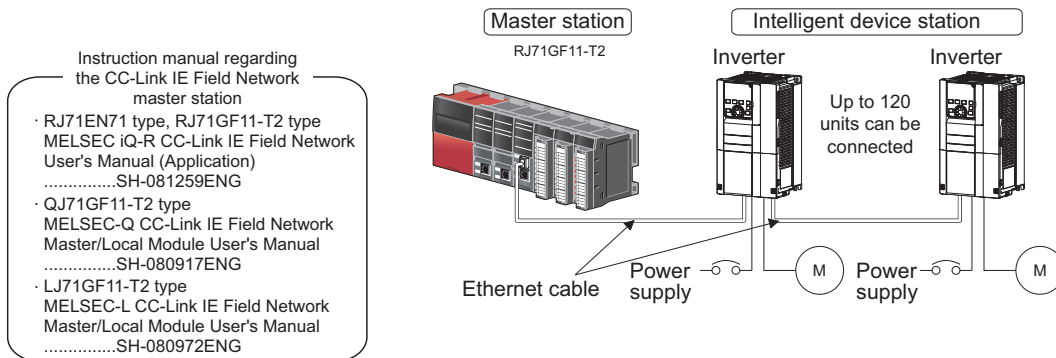

## 2.11.2 Network configuration

### ◆ Network topology

- The network can be wired into star topology, line topology, and ring topology.
- A network can consist of a combination of star and line topologies, but the ring topology cannot be combined with star or line topology.

Item	Description
Star topology	Modules are configured into a star using a switching hub and Ethernet cables. Slave stations can be easily added in a star topology. Furthermore, data link continues among normally-operating stations in a star topology.*1
Line topology	Modules are configured into a line with Ethernet cables. A switching hub is not required. If an error occurs, the station in error and the stations after that are disconnected from the network.*1
Ring topology	Modules are configured into a ring using Ethernet cables. Data link continues with the stations that are operating normally. A switching hub is not required.*1

\*1 Add/remove slave stations one by one. If multiple slave stations are added/removed at a time, all stations on the network will be reconnected, resulting in a momentarily error in all the stations.

### ◆ Station number and connection position

- Modules can be connected in any order regardless of the station number.

### ◆ Cascade connection

- Up to 20-layer connection is available for the cascade connection.

### ◆ Replacing CC-Link IE Field Network devices

- For star topology, slave stations can be replaced without powering off the whole system.

#### NOTE

- Refer to the MELSEC iQ-R, MELSEC-Q, or MELSEC-L CC-Link IE Field Network Master/Local Module User's Manual for the detailed network configurations.

## 2.11.3 Network components

This section describes components comprising the CC-Link IE Field Network.

## ◆ Connection cable

- For wiring, use the 1000BASE-T compliant Ethernet cables.

Ethernet cable	Board mounted option connector	Type
Category 5e or higher straight cable (double shielded/STP)	RJ-45 connector	The following conditioning cables: <ul style="list-style-type: none"> <li>IEEE802.3 (1000BASE-T)</li> <li>ANSI/TIA/EIA-568-B (Category 5e)</li> </ul>

- Recommended products (as of October 2020)

Model	Manufacturer
SC-E5EW series <sup>*1</sup>	Mitsubishi Electric System & Service Co., Ltd.

<sup>\*1</sup> SC-E5EW cable is for in-enclosure and indoor uses. SC-E5EW-L cable is for outdoor use.

### NOTE

- For CC-Link IE Field Network wiring, use the recommended wiring components by CC-Link Partner Association.
- Cables for CC-Link IE Controller Network cannot be used for CC-Link IE Field Network.
- Depending on the cable connector shape, the cable may not be connected to the communication connector.

## ◆ Hubs

- Use hubs that meet the following conditions. Operation is not guaranteed if the hubs do not meet these conditions.
  - Compliance with the IEEE802.3 (1000BASE-T)
  - Support of the auto MDI/MDI-X function
  - Support of the auto-negotiation function
  - Switching hub (layer 2 switch)<sup>\*1</sup>

<sup>\*1</sup> A repeater hub is not available.

- Industrial switching hub

Model	Manufacturer
NZ2EHG-T8	Mitsubishi Electric Corporation

## 2.11.4 Component names of the CC-Link IE Field Network communication circuit board

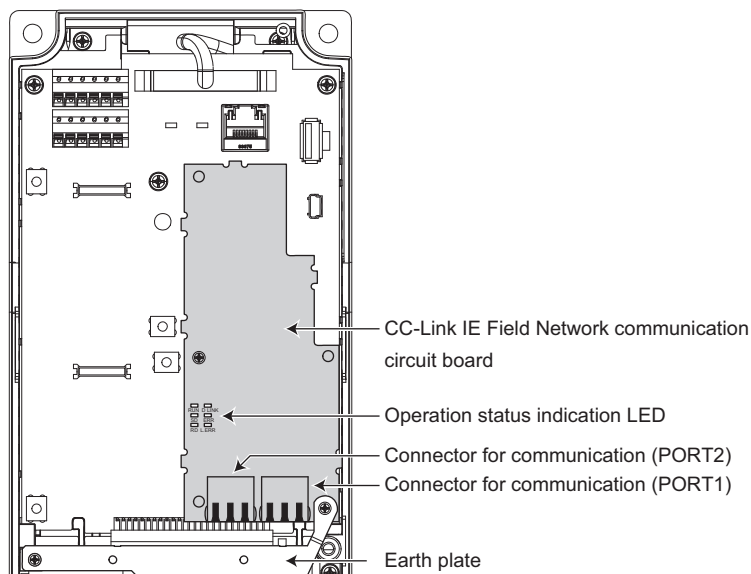

### NOTE

- Do not remove the CC-Link IE Field Network communication circuit board or the earth plate.

## 2.11.5 Wiring method

### ◆ Ethernet cable connection

- Connect or remove an Ethernet cable after switching the power of the inverter OFF.
- When wiring the Ethernet cable to the communication connector, check the connecting direction of the Ethernet cable connector. Insert the connector to the communication connector until it clicks.
- When removing the Ethernet cable from the communication connector, hold down the latch on the Ethernet cable connector, and pull out the cable while holding the latch.

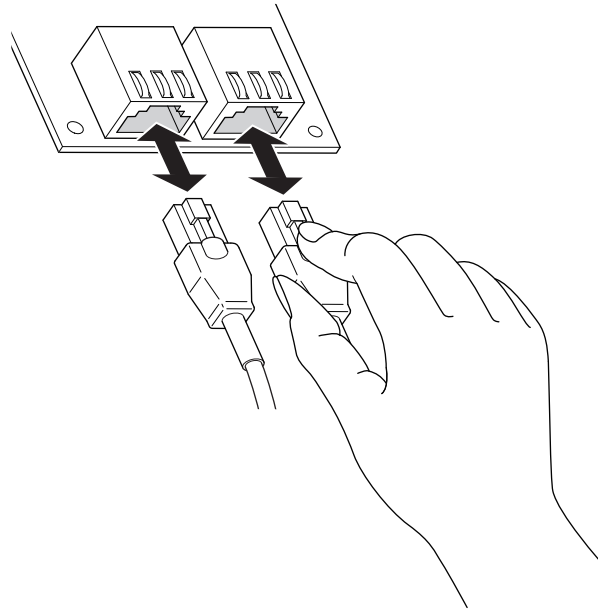

#### NOTE

- PORT 1 and PORT 2 do not need to be distinguished.
  - When only one connector is used in star topology, either PORT 1 or PORT 2 is applicable.
  - When using two connectors for line topology and ring topology, an Ethernet cable can be connected to the connectors in any combination. For example, the cable can be connected across two of PORT 1 or across PORT 1 and PORT 2.

Connection between PORT1 and PORT1, PORT2 and PORT2

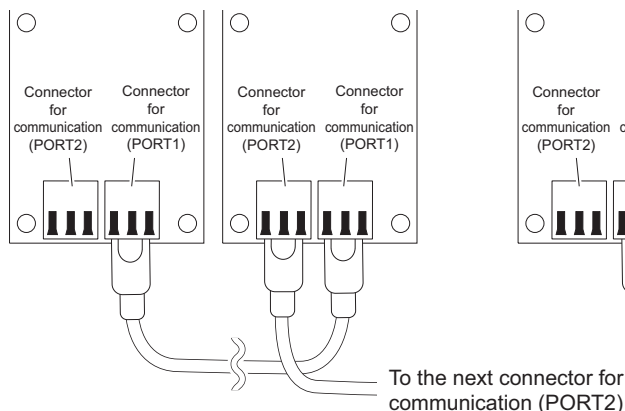

Connection between PORT1 and PORT2

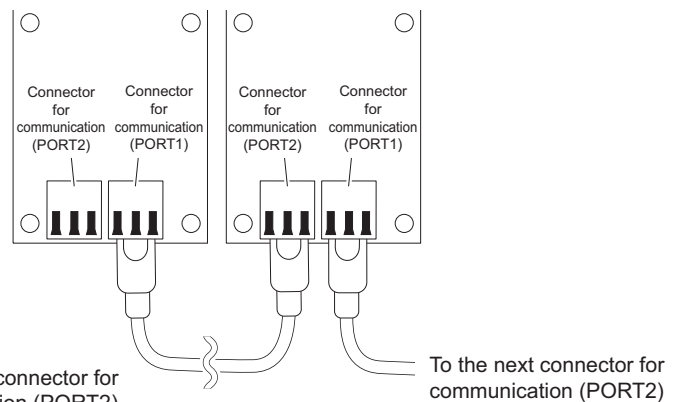

### ◆ Precautions

- Do not touch the core of the cable-side or module-side connector, and protect it from dirt or dust. If oil from your hand, dirt or dust is attached to the core, it can increase transmission loss, arising a problem in data link.

- Check the following:
  - Is any Ethernet cable disconnected?
  - Is any of the Ethernet cables shorted?
  - Are the connectors securely connected?
- Do not use Ethernet cables with broken latches. Doing so may cause the cable to unplug or malfunction.
- Hold the connector part when connecting and disconnecting the Ethernet cable. Pulling a cable connected to the module may damage the module or cable, or result in malfunction due to poor contact.
- The maximum station-to-station distance is 100 m. However, the distance may be shorter depending on the operating environment of the cable. For details, contact your cable manufacturer.
- Check the instructions on [page 110](#) before wiring, and perform correct wiring.
- When the operations listed below are performed, all stations on the network may be reconnected. At that time, a data link error may momentarily occur in all the stations, and the communication error E.OP1 may occur in the connected inverters.

Network configuration	Operation
Star topology	<ul style="list-style-type: none"> <li>• Powering ON/OFF a slave station or the switching hub</li> <li>• Connecting/disconnecting an Ethernet cable connected to the switching hub</li> <li>• Disconnecting an Ethernet cable from a slave station and connecting it to another slave station or to the switching hub</li> <li>• Disconnecting ten stations or more, or disconnecting half the number of slave stations in the system or more</li> <li>• Changing the network topology when adding a slave station</li> </ul>
Line topology / ring topology	<ul style="list-style-type: none"> <li>• Simultaneously powering ON/OFF multiple stations</li> <li>• Simultaneously connecting/disconnecting Ethernet cables to/from multiple stations (When a data link faulty station returns, a data link error will occur in all the stations.)</li> <li>• Disconnecting ten stations or more, or disconnecting half the number of slave stations in the system or more</li> <li>• Changing the network topology when adding a slave station</li> </ul>

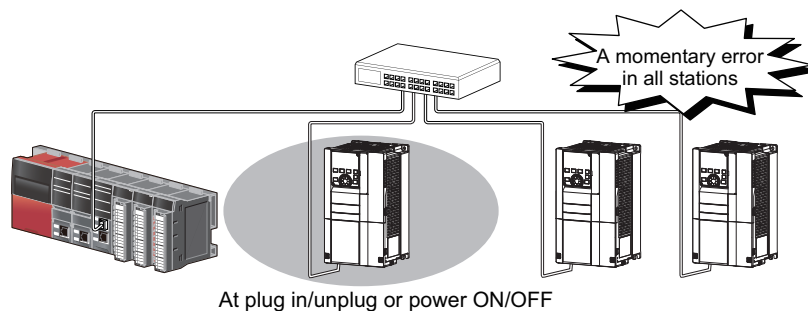

- To keep outputting a data link error (inverter communication error), set **Pr.500 Communication error execution waiting time** or **Pr.502 Stop mode selection at communication error**.

#### NOTE

- When wiring cables to the inverter's RS-485 terminals, take caution not to let the cables touch the CC-Link IE Field Network communication circuit board or of the inverter's circuit board. Otherwise, electromagnetic noises may cause malfunctions.
- After wiring, wire offcuts must not be left in the inverter. Doing so may cause a fault, failure, or malfunction.

## 2.11.6 Operation status LEDs

- Check the operation status LED to confirm the CC-Link IE Field Network operating status.

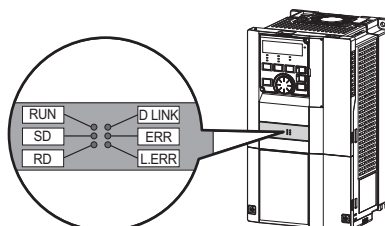

LED name	Description	ON	OFF
RUN	Operating status	Normal operation (normal 5 V internal voltage) <sup>*1</sup>	Hardware failure
SD	Transmission status	Data transmitting	No data transmitting
RD	Reception status	Data receiving	No data receiving
D LINK	Cyclic communication status	Cyclic transmitting	No cyclic transmitting or disconnected
ERR	Node failure status <sup>*2</sup>	Node failure	Normal operation
L.ERR	Link error	Received data error	Received data normal

\*1 Also lit in no-communication state.

\*2 This LED indicates a communication break between the master station and the inverter (due to cable disconnection or breakage, power-OFF of the master power supply, or reset, etc.).

# CHAPTER 3 PRECAUTIONS FOR USE OF THE INVERTER

3.1	Electro-magnetic interference (EMI) and leakage currents .....	116
3.2	Power supply harmonics.....	123
3.3	Installation of a reactor .....	127
3.4	Power shutdown and magnetic contactor (MC).....	128
3.5	Countermeasures against deterioration of the 400 V class motor insulation.....	130
3.6	Checklist before starting operation .....	131
3.7	Failsafe system which uses the inverter .....	134



# 3 PRECAUTIONS FOR USE OF THE INVERTER

---

This chapter explains the precautions for use of this product.

Always read the instructions before use.

For the separated converter type, refer to the "PRECAUTIONS FOR USE OF THE INVERTER" in the FR-A802 (Separated Converter Type) Instruction Manual (Hardware).

For the IP55 compatible model, refer to the "PRECAUTIONS FOR USE OF THE INVERTER" in the FR-A806 (IP55/UL Type 12 specification) Instruction Manual (Hardware).

## 3.1 Electro-magnetic interference (EMI) and leakage currents

---

### 3.1.1 Leakage currents and countermeasures

Capacitance exists between the inverter I/O cables, other cables and earth and in the motor, through which a leakage current flows. The amount of current leakage depends on the factors such as the size of the capacitance and the carrier frequency. Low acoustic noise operation at an increased carrier frequency of the inverter will increase current leakage. Take the following precautions to prevent current leakage. Earth leakage circuit breakers should be selected based on their rated current sensitivity, independently of the carrier frequency setting.

#### ◆ To-earth (ground) leakage currents

Leakage currents may flow not only into the power system of the inverter but also into the other power systems through the earthing (grounding) cable, etc. These leakage currents may operate earth leakage circuit breakers and earth leakage relays unnecessarily.

##### ■ Precautions

- If the carrier frequency setting is high, decrease the **Pr.72 PWM frequency selection** setting.  
Note that motor noise increases. Selecting **Pr.240 Soft-PWM operation selection** makes the sound inoffensive.
- By using earth leakage circuit breakers designed to suppress harmonics and surge voltage in the power system of the inverter and other devices, operation can be performed with the carrier frequency kept high (with low noise).

##### NOTE

- Long wiring will increase the leakage current.
- High motor capacity will increase the leakage current. The leakage current of the 400 V class is larger than that of the 200 V class.

#### ◆ Line-to-line leakage currents

Harmonics of leakage currents flowing in static capacitance between the inverter output cables may operate the external thermal relay unnecessarily. When the wiring length is long (50 m or more) for the 400 V class small-capacity models (FR-A840-00250(7.5K) or lower), the external thermal relay is likely to operate unnecessarily because the ratio of the leakage current to the rated motor current increases.

## Line-to-line leakage current example (200 V class)

Motor capacity (kW)	Rated motor current (A)	Leakage current (mA) <sup>*1</sup>		Condition
		Wiring length 50 m	Wiring length 100 m	
0.4	1.8	310	500	<ul style="list-style-type: none"> <li>• Motor: SF-JR 4P</li> <li>• Carrier frequency: 14.5 kHz</li> <li>• Cable: 2 mm<sup>2</sup>, 4 cores</li> <li>• Cabtyre cable</li> </ul>
0.75	3.2	340	530	
1.5	5.8	370	560	
2.2	8.1	400	590	
3.7	12.8	440	630	
5.5	19.4	490	680	
7.5	25.6	535	725	

\*1 The leakage currents of the 400 V class are about twice as large.

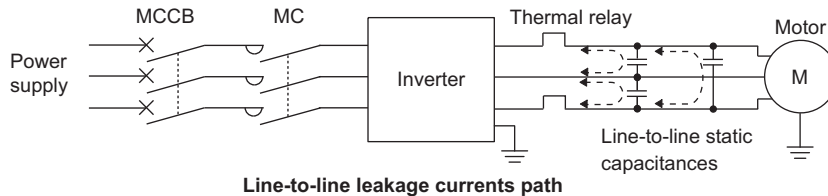

## Countermeasures

- Use **Pr.9 Electronic thermal O/L relay**.
- If the carrier frequency setting is high, decrease the **Pr.72 PWM frequency selection** setting. Note that motor noise increases. Selecting **Pr.240 Soft-PWM operation selection** makes the sound inoffensive. To ensure that the motor is protected against line-to-line leakage currents, it is recommended to use a temperature sensor to directly detect motor temperature.

## Installation and selection of the molded case circuit breaker

Install a molded case circuit breaker (MCCB) on the power receiving side to protect the wiring at the inverter input side. Select an MCCB according to the inverter input side power factor, which depends on the power supply voltage, output frequency and load. Especially for a completely electromagnetic MCCB, a slightly large capacity must be selected since its operation characteristic varies with harmonic currents. (Check it in the data of the corresponding breaker.) As an earth leakage current breaker, use the Mitsubishi earth leakage current breaker designed for harmonics and surge suppression.

## Selecting the rated sensitivity current for the earth leakage circuit breaker

To install the earth leakage circuit breaker on the inverter circuit, select its rated sensitivity current as follows, independently of the PWM carrier frequency.

- Breaker designed for harmonic and surge suppression  
Rated sensitivity current  
 $I_{\Delta n} \geq 10 \times (I_{g1} + I_{gn} + I_{gi} + I_{g2} + I_{gm})$
  - Standard breaker  
Rated sensitivity current  
 $I_{\Delta n} \geq 10 \times \{I_{g1} + I_{gn} + I_{gi} + 3 \times (I_{g2} + I_{gm})\}$
- $I_{g1}, I_{g2}$ : Leakage currents in wire path during commercial power supply operation  
 $I_{gn}$ : Leakage current from noise filters on the input side of the inverter  
 $I_{gm}$ : Leakage current from the motor during commercial power supply operation  
 $I_{gi}$ : Leakage current of inverter unit

Example of leakage current of cable path per 1 km during the commercial power supply operation when the CV cable is routed in metal conduit (200 V 60 Hz)

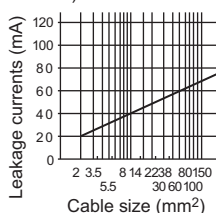

Leakage current example of three-phase induction motor during the commercial power supply operation (200 V 60 Hz)

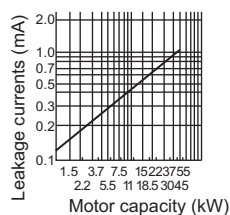

Example of leakage current of cable path per 1 km during the commercial power supply operation when the CV cable is routed in metal conduit

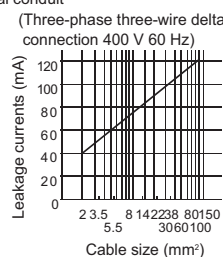

Leakage current example of three-phase induction motor during the commercial power supply operation

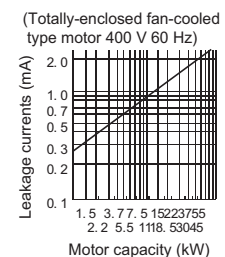

For "Δ" connection, the amount of leakage current is approx. 1/3 of the above value.

### Example

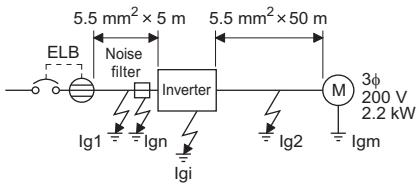

Item	Breaker designed for harmonic and surge suppression	Standard breaker
Leakage current $I_{g1}$ (mA)	$33 \times \frac{5m}{1000m} = 0.17$	
Leakage current $I_{gn}$ (mA)	0 (without noise filter)	
Leakage current $I_{gi}$ (mA)	1 (without EMC filter). For the leakage current of the inverter, refer to the following table.	
Leakage current $I_{g2}$ (mA)	$33 \times \frac{50m}{1000m} = 1.65$	
Motor leakage current $I_{gm}$ (mA)	0.18	
Total leakage current (mA)	3.00	6.66
Rated sensitivity current (mA) ( $\geq I_g \times 10$ )	30	100

Inverter leakage current (with and without EMC filter)

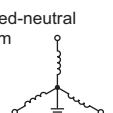
	Voltage (V)	EMC filter		Remarks
		ON (mA)	OFF (mA)	
Phase earthing (grounding) 	200	22	1	Input power conditions 220 V/60 Hz (200 V class) or 440 V/60 Hz (400 V class), within 3% of power supply unbalance
	400	35	2	
Earthed-neutral system 	400	2	1	

### NOTE

- Install the earth leakage circuit breaker (ELB) on the input side of the inverter.
- In the  $\Delta$  connection earthed-neutral system, the sensitivity current is blunt against a ground fault in the inverter output side. Earthing (Grounding) must conform to the requirements of national and local safety regulations and electrical codes. (NEC section 250, IEC 61140 class 1 and other applicable standards)
- When the breaker is installed on the output side of the inverter, it may be unnecessarily operated by harmonics even if the effective value is within the rating.  
In this case, do not install the breaker since the eddy current and hysteresis loss will increase, leading to temperature rise.
- The following models and products are standard breakers: the models BV-C1, BC-V, NVB, NV-L, NV-G2N, NV-G3NA, and NV-2F, the earth leakage circuit breakers with AA neutral wire open-phase protection, and the earth leakage relays (except NV-ZHA).  
The other series, models, and products are designed for harmonic and surge suppression: the NV-C series, NV-S series, MN series, the models NV30-FA, NV50-FA, NV-H, and BV-C2, earth leakage alarm breaker NF-Z, and the earth leakage relay NV-ZHA.

## 3.1.2 Techniques and measures for electromagnetic compatibility (EMC)

Some electromagnetic noises enter the inverter to cause the inverter malfunction, and others are radiated by the inverter to cause the peripheral devices to malfunction. (The former is called EMS problem, the latter is called EMI problem, and both is called EMC problem.) Though the inverter is designed to be immune to noises, it requires the following basic measures and EMS measures as it handles low-level signals. Pay attention to the electromagnetic noises that could be generated by the inverter since the inverter chops outputs at high carrier frequency. If these electromagnetic noises cause peripheral devices to malfunction, EMI countermeasures should be taken to suppress noises. These techniques differ slightly depending on EMI paths.

### ◆ Basic measures

- Do not run the power cables (I/O cables) and signal cables of the inverter in parallel with each other and do not bundle them.

- Use shielded twisted pair cables for the detector connecting and control signal cables and connect the sheathes of the shielded cables to terminal SD.
- Ground (Earth) the inverter, motor, etc. at one point.

### ◆ EMS measures to reduce electromagnetic noises that enter the inverter and cause it to malfunction

When devices that generate many electromagnetic noises (which use magnetic contactors, electromagnetic brakes, many relays, for example) are installed near the inverter and the inverter may malfunction due to electromagnetic noises, the following countermeasures must be taken:

- Provide surge suppressors for devices that generate many electromagnetic noises to suppress electromagnetic noises.
- Install data line filters to signal cables (refer to [page 120](#)).
- Ground (Earth) the shields of the detector connection and control signal cables with cable clamp metal.

### ◆ EMI measures to reduce electromagnetic noises that are radiated by the inverter to cause the peripheral devices to malfunction

Inverter-generated noises are largely classified into those radiated by the inverter itself and by the I/O cables connected to its main circuit, those electromagnetically and electrostatically induced to the signal cables of the peripheral devices close to the power cable connected to the inverter main circuit, and those transmitted through the power cables.

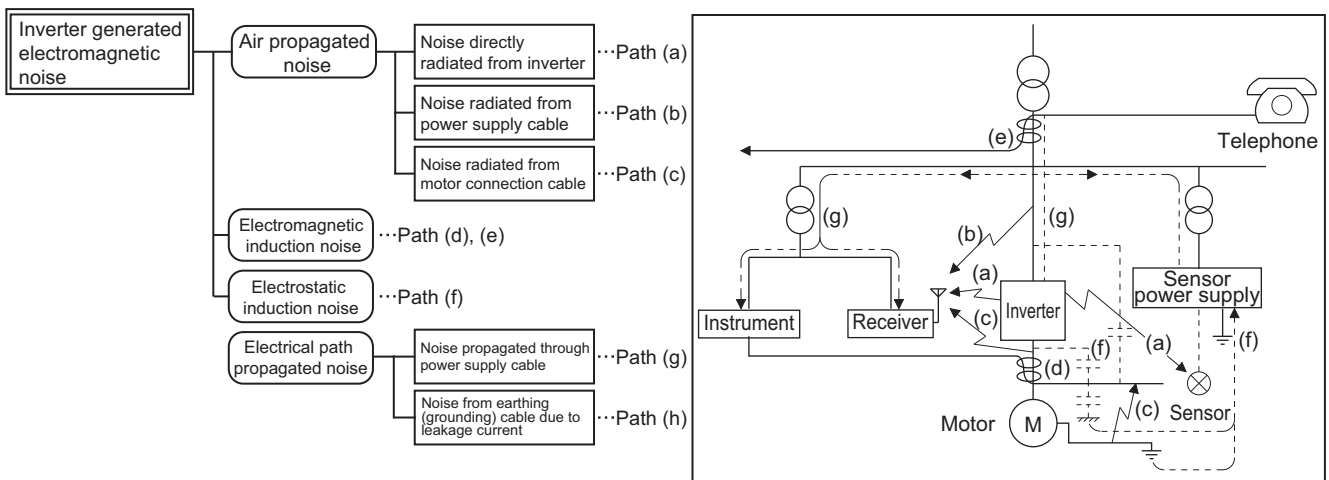

Noise propagation path	Countermeasure
(a), (b), (c)	<p>When devices that handle low-level signals and are liable to malfunction due to electromagnetic noises, e.g. instruments, receivers and sensors, are contained in the enclosure that contains the inverter or when their signal cables are run near the inverter, the devices may malfunction due to by air-propagated electromagnetic noises. The following countermeasures must be taken:</p> <ul style="list-style-type: none"> <li>• Install easily affected devices as far away as possible from the inverter.</li> <li>• Run easily affected signal cables as far away as possible from the inverter and its I/O cables.</li> <li>• Do not run the signal cables and power cables (inverter I/O cables) in parallel with each other and do not bundle them.</li> <li>• Set the EMC filter ON/OFF connector of the inverter to the ON position. (Refer to <a href="#">page 120</a>.)</li> <li>• Inserting a line noise filter into the output suppresses the radiated noise from the cables.</li> <li>• Use shielded cables as signal cables and power cables and run them in individual metal conduits to produce further effects.</li> </ul>
(d), (e), (f)	<p>When the signal cables are run in parallel with or bundled with the power cables, magnetic and static induction noises may be propagated to the signal cables to cause malfunction of the devices and the following countermeasures must be taken:</p> <ul style="list-style-type: none"> <li>• Install easily affected devices as far away as possible from the inverter.</li> <li>• Run easily affected signal cables as far away as possible from the inverter and its I/O cables.</li> <li>• Do not run the signal cables and power cables (inverter I/O cables) in parallel with each other and do not bundle them.</li> <li>• Use shielded cables as signal cables and power cables and run them in individual metal conduits to produce further effects.</li> </ul>
(g)	<p>When the peripheral devices use the power system of the inverter, its generated noises may flow back through the power supply cables to cause malfunction of the devices and the following countermeasures must be taken:</p> <ul style="list-style-type: none"> <li>• Set the EMC filter ON/OFF connector of the inverter to the ON position. (Refer to <a href="#">page 120</a>.)</li> <li>• Install the line noise filter (FR-BLF/FR-BSF01) to the power cables (output cables) of the inverter.</li> </ul>

Noise propagation path	Countermeasure
(h)	When a closed loop circuit is formed by connecting the peripheral device wiring to the inverter, leakage currents may flow through the earthing (grounding) cable of the inverter to cause the device to malfunction. In that case, disconnecting the earthing (grounding) cable from the device may stop the malfunction of the device.

### ■ Data line filter

Data line filter is effective as an EMI countermeasure. Provide a data line filter for the detector cable, etc.

- Commercially available data line filter: ZCAT3035-1330 (by TDK), ESD-SR-250 (by TOKIN)
- Specification example (ZCAT3035-1330 by TDK)

Item	Description	
Impedance (Ω)	10 to 100 MHz	80
	100 to 500 MHz	150
Outline dimension drawings (mm)		

The impedance values above are reference values, and not guaranteed values.

### ■ EMI measure example

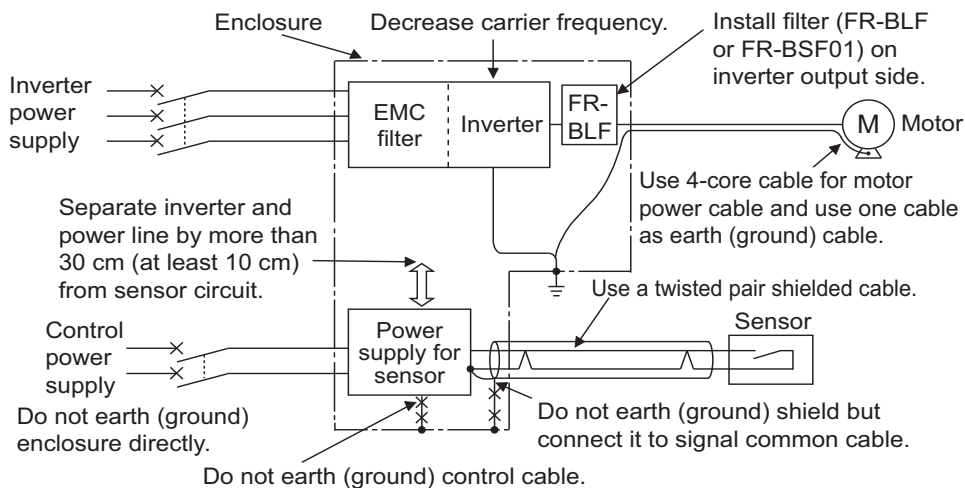

#### NOTE

- For compliance with the EU EMC Directive, refer to the Instruction Manual (Startup).

## 3.1.3 Built-in EMC filter

This inverter is equipped with a built-in EMC filter (capacitive filter) and a common mode choke.

These are effective in reducing air-propagated noise on the input side of the inverter.

To enable the EMC filter, set the EMC filter ON/OFF connector to the ON position. The FM type is initially set to "disabled" (OFF), and the CA type to "enabled" (ON).

The input side common mode choke, which is built in the FR-A820-03160(55K) or lower and the FR-A840-01800(55K) or lower inverter, is always enabled regardless of the EMC filter ON/OFF connector setting.

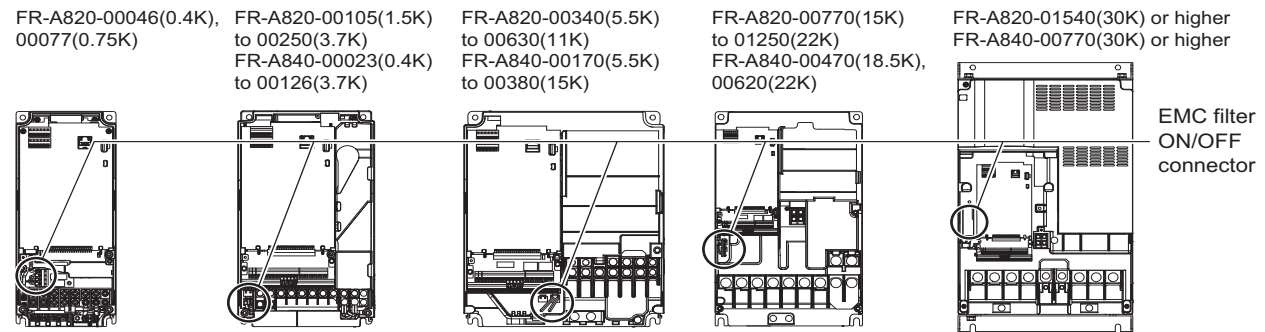
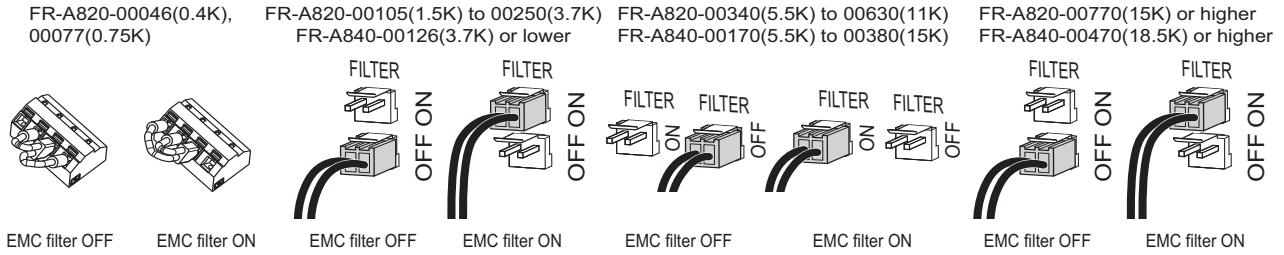

## ◆ How to enable or disable the filter

### ■ For FR-A820-00105(1.5K) or higher and FR-A840-00023(0.4K) or higher

- Before removing a front cover, check to make sure that the indication of the inverter operation panel is OFF, wait for at least 10 minutes after the power supply has been switched OFF, and check that there is no residual voltage using a digital multimeter or the like.
- When disconnecting the connector, push the fixing tab and pull the connector straight without pulling the cable or forcibly pulling the connector with the tab fixed.  
When installing the connector, also engage the fixing tab securely.  
(If it is difficult to disconnect the connector, use a pair of needle-nose pliers, etc.)

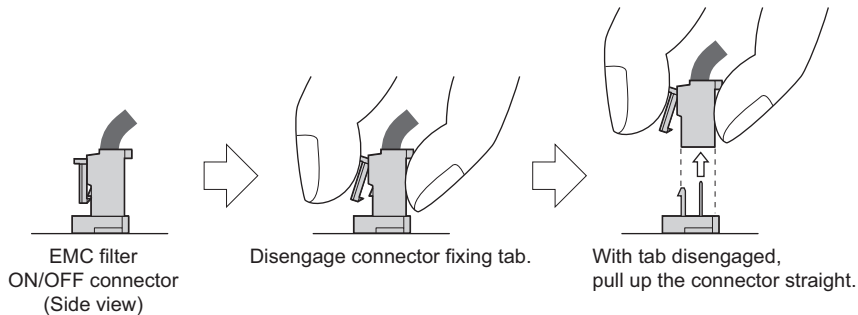

### ■ For FR-A820-00077(0.75K) or lower

- Before removing a front cover, check to make sure that the indication of the inverter operation panel is OFF, wait for at least 10 minutes after the power supply has been switched OFF, and check that there is no residual voltage using a digital multimeter or the like.
- Remove the control circuit terminal block. (Refer to [page 819](#).)
- Connect the shorting wire to the corresponding terminal to enable or disable the filter. Connect the wire to the terminal in the same way as general wiring of the control circuit terminal block. (Refer to [page 74](#).)
- After switching, reinstall the control circuit terminal block as it was.

### NOTE

- Fit the connector or shorting wire to either ON or OFF position.
- Enabling (turning ON) the EMC filter increases leakage current. (Refer to [page 117](#).)

 **WARNING**

- While power is ON or when the inverter is running, do not open the front cover. Otherwise you may get an electric shock.

## 3.2 Power supply harmonics

### 3.2.1 Power supply harmonics

The inverter may generate power supply harmonics from its converter circuit to affect the power generator, power factor correction capacitor etc. Power supply harmonics are different from noise and leakage currents in source, frequency band and transmission path. Take the following countermeasure suppression techniques.

- Differences between harmonics and noises

Item	Harmonics	Noise
frequency	Normally 40th to 50th degrees or less (3 kHz or less).	High frequency (several 10 kHz to 1 GHz order).
Location	To-electric channel, power impedance.	To-space, distance, wiring path.
Quantitative understanding	Theoretical calculation possible.	Random occurrence, quantitative grasping difficult.
Generated amount	Nearly proportional to the load capacity.	Changes with the current variation ratio. (Gets larger as switching speed increases.)
Affected equipment immunity	Specified by standards per equipment.	Different depending on maker's equipment specifications.
Countermeasure	Provide a reactor.	Increase distance.

- Countermeasures

The harmonic current generated from the inverter to the input side differs according to various conditions such as the wiring impedance, whether a reactor is used or not, and output frequency and output current on the load side.

For the output frequency and output current, we understand that this should be calculated in the conditions under the rated load at the maximum operating frequency.

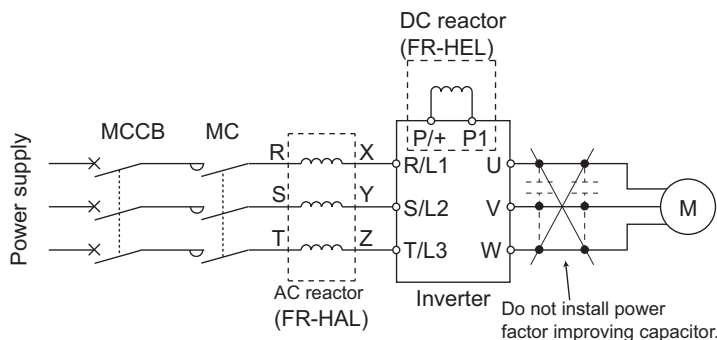

#### NOTE

- The power factor improving capacitor and surge suppressor on the inverter output side may be overheated or damaged by the harmonic components of the inverter output. Also, since an excessive current flows in the inverter to activate overcurrent protection, do not provide a capacitor and surge suppressor on the inverter output side when the motor is driven by the inverter. For power factor improvement, install a reactor on the inverter input side or in the DC circuit.

### 3.2.2 Harmonic suppression guidelines in Japan

Inverters have a converter section (rectifier circuit) and generate a harmonic current.

Harmonic currents flow from the inverter to a power receiving point via a power transformer. The Harmonic Suppression Guidelines was established to protect other consumers from these outgoing harmonic currents.



The three-phase 200 V input specifications 3.7 kW or lower were previously covered by "the Harmonic Suppression Guidelines for Household Appliances and General-purpose Products" and other models were covered by "the Harmonic Suppression Guidelines for Consumers Who Receive High Voltage or Special High Voltage". However, the transistorized inverter has been excluded from the target products covered by "the Harmonic Suppression Guidelines for Household Appliances and General-purpose Products" in January 2004 and "the Harmonic Suppression Guideline for Household Appliances and General-purpose Products" was repealed on September 6, 2004.

All capacity and all models of general-purpose inverter used by specific consumers are now covered by "the Harmonic Suppression Guidelines for Consumers Who Receive High Voltage or Special High Voltage" (hereinafter referred to as "the Specific Consumer Guidelines").

- "Specific Consumer Guidelines"

This guideline sets forth the maximum harmonic currents outgoing from a high-voltage or especially high-voltage receiving consumer who will install, add or renew harmonic generating equipment. If any of the maximum values is exceeded, this guideline requires that consumer to take certain suppression measures.

- Maximum values of outgoing harmonic currents per 1 kW contract power

Received power voltage	5th	7th	11th	13th	17th	19th	23rd	Over 23rd
6.6 kV	3.5	2.5	1.6	1.3	1.0	0.9	0.76	0.70
22 kV	1.8	1.3	0.82	0.69	0.53	0.47	0.39	0.36
33 kV	1.2	0.86	0.55	0.46	0.35	0.32	0.26	0.24

### ◆ Application of the specific consumer guidelines

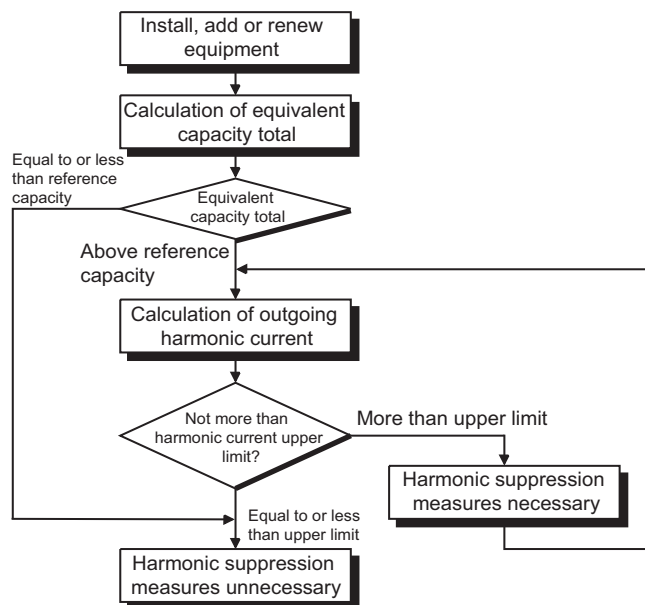

### ■ Conversion factor

Classification	Circuit type	Conversion factor Ki	
3	Three-phase bridge (capacitor smoothing)	Without reactor	K31 = 3.4
		With reactor (AC side)	K32 = 1.8
		With reactor (DC side)	K33 = 1.8
		With reactors (AC, DC sides)	K34 = 1.4
5	Self-excitation three-phase bridge	When a high power factor converter is used	K5 = 0

## ■ Equivalent capacity limit

Received power voltage	Reference capacity
6.6 kV	50 kVA
22/33 kV	300 kVA
66 kV or more	2000 kVA

## ■ Harmonic content (when the fundamental current is considered as 100%)

Reactor	5th	7th	11th	13th	17th	19th	23rd	25th
Not used	65	41	8.5	7.7	4.3	3.1	2.6	1.8
Used (AC side)	38	14.5	7.4	3.4	3.2	1.9	1.7	1.3
Used (DC side)	30	13	8.4	5.0	4.7	3.2	3.0	2.2
Used (AC, DC sides)	28	9.1	7.2	4.1	3.2	2.4	1.6	1.4

## ■ Calculation of equivalent capacity P<sub>0</sub> of harmonic generating equipment

"Equivalent capacity" is the capacity of a 6-pulse converter converted from the capacity of consumer's harmonic generating equipment and is calculated by the following equation. If the sum of equivalent capacities is higher than the limit (refer to the list of the equivalent capacity limits), harmonics must be calculated by the equation in next subheading.

$$P_0 = \sum (K_i \times P_i) \text{ [kVA]}$$

K<sub>i</sub>: Conversion factor (Refer to the list of the conversion factors.)

P<sub>i</sub>: Rated capacity of harmonic generating equipment\*1 [kVA]

i: Number indicating the conversion circuit type

\*1 Rated capacity: Determined by the capacity of the applied motor and found in the table "Rated capacities and outgoing harmonic currents of inverter-driven motors". The rated capacity used here is used to calculate the generated harmonic amount and is different from the power supply capacity required for actual inverter drive.

## ■ Calculation of outgoing harmonic current

Outgoing harmonic current = fundamental wave current (value converted from received power voltage) × operation ratio × harmonic content

- Operation ratio: actual load factor × operation time ratio during 30 minutes
- Harmonic content: Refer to the list of the harmonic content.

## ■ Rated capacities and outgoing harmonic currents of inverter-driven motors

Applicable motor (kW)	Fundamental wave current (A)		Fundamental wave current converted from 6.6 kV (mA)	Rated capacity (kVA)	Outgoing harmonic current converted from 6.6 kV (mA) (No reactor, 100% operation ratio)							
	200 V	400 V			5th	7th	11th	13th	17th	19th	23rd	25th
0.4	1.61	0.81	49	0.57	31.85	20.09	4.165	3.773	2.107	1.519	1.274	0.882
0.75	2.74	1.37	83	0.97	53.95	34.03	7.055	6.391	3.569	2.573	2.158	1.494
1.5	5.50	2.75	167	1.95	108.6	68.47	14.20	12.86	7.181	5.177	4.342	3.006
2.2	7.93	3.96	240	2.81	156.0	98.40	20.40	18.48	10.32	7.440	6.240	4.320
3.7	13.0	6.50	394	4.61	257.1	161.5	33.49	30.34	16.94	12.21	10.24	7.092
5.5	19.1	9.55	579	6.77	376.1	237.4	49.22	44.58	24.90	17.95	15.05	10.42
7.5	25.6	12.8	776	9.07	504.4	318.2	65.96	59.75	33.37	24.06	20.18	13.97
11	36.9	18.5	1121	13.1	728.7	459.6	95.29	86.32	48.20	34.75	29.15	20.18
15	49.8	24.9	1509	17.6	980.9	618.7	128.3	116.2	64.89	46.78	39.24	27.16
18.5	61.4	30.7	1860	21.8	1209	762.6	158.1	143.2	79.98	57.66	48.36	33.48
22	73.1	36.6	2220	25.9	1443	910.2	188.7	170.9	95.46	68.82	57.72	39.96
30	98.0	49.0	2970	34.7	1931	1218	252.5	228.7	127.7	92.07	77.22	53.46
37	121	60.4	3660	42.8	2379	1501	311.1	281.8	157.4	113.5	95.16	65.88
45	147	73.5	4450	52.1	2893	1825	378.3	342.7	191.4	138.0	115.7	80.10
55	180	89.9	5450	63.7	3543	2235	463.3	419.7	234.4	169.0	141.7	98.10

Applicable motor (kW)	Fundamental wave current (A)		Fundamental wave current converted from 6.6 kV (mA)	Rated capacity (kVA)	Outgoing harmonic current converted from 6.6 kV (mA) (with a DC reactor, 100% operation ratio)							
	200 V	400 V			5th	7th	11th	13th	17th	19th	23rd	25th
75	245	123	7455	87.2	2237	969	626	373	350	239	224	164
90	293	147	8909	104	2673	1158	748	445	419	285	267	196
110	357	179	10848	127	3254	1410	911	542	510	347	325	239
132	—	216	13091	153	3927	1702	1100	655	615	419	393	288
160	—	258	15636	183	4691	2033	1313	782	735	500	469	344
220	—	355	21515	252	6455	2797	1807	1076	1011	688	645	473
250	—	403	24424	286	7327	3175	2052	1221	1148	782	733	537
280	—	450	27273	319	8182	3545	2291	1364	1282	873	818	600
315	—	506	30667	359	9200	3987	2576	1533	1441	981	920	675
355	—	571	34606	405	10382	4499	2907	1730	1627	1107	1038	761
400	—	643	38970	456	11691	5066	3274	1949	1832	1247	1169	857
450	—	723	43818	512	13146	5696	3681	2191	2060	1402	1315	964
500	—	804	48727	570	14618	6335	4093	2436	2290	1559	1462	1072
560	—	900	54545	638	16364	7091	4582	2727	2564	1746	1636	1200
630	—	1013	61394	718	18418	7981	5157	3070	2886	1965	1842	1351

### ■ Determining if a countermeasure is required

A countermeasure for harmonics is required if the following condition is satisfied: outgoing harmonic current > maximum value per 1 kW contract power × contract power.

### ■ Harmonic suppression techniques

No.	Item	Description
1	Reactor installation (FR-HAL, FR-HEL)	Install an AC reactor (FR-HAL) on the AC side of the inverter or a DC reactor (FR-HEL) on its DC side, or install both to suppress outgoing harmonic currents.
2	High power factor converter (FR-HC2), multifunction regeneration converter (FR-XC)	This converter trims the current waveform to be a sine waveform by switching the rectifier circuit (converter module) with transistors. Doing so suppresses the generated harmonic amount significantly. Connect it to the DC area of an inverter. Use the high power factor converter (FR-HC2) with the accessories that come as standard. To use the FR-XC series converter, use the converter with an FR-XCB box-type reactor and enable the harmonic suppression function.
3	Installation of power factor improving capacitor	When used with a reactor connected in series, the power factor improving correction capacitor can absorb harmonic currents.
4	Transformer multi-phase operation	Use two transformers with a phase angle difference of 30° in combinations of $\lambda$ to $\Delta$ and $\Delta$ to $\Delta$ , to provide an effect corresponding to 12 pulses, reducing low-degree harmonic currents.
5	Passive filter (AC filter)	A capacitor and a reactor are used together to reduce impedances at specific frequencies. Harmonic currents are expected to be absorbed greatly by using this technique.
6	Active filter	This filter detects the current in a circuit generating a harmonic current and generates a harmonic current equivalent to a difference between that current and a fundamental wave current to suppress the harmonic current at the detection point. Harmonic currents are expected to be absorbed greatly by using this technique.

# 3.3 Installation of a reactor

When the inverter is connected near a large-capacity power transformer (1000 kVA or more) or when a power factor correction capacitor is to be switched over, an excessive peak current may flow in the power input circuit, damaging the converter circuit. To prevent this, always install an AC reactor (FR-HAL), which is available as an option.

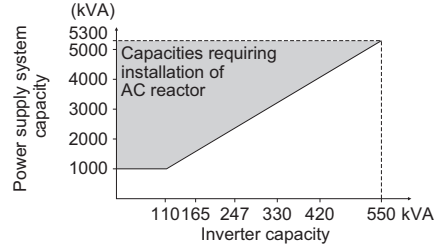
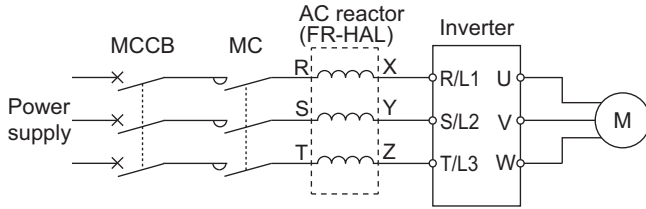

## 3.4 Power shutdown and magnetic contactor (MC)

### ◆ Inverter input side magnetic contactor (MC)

On the inverter input side, it is recommended to provide an MC for the following purposes. (Refer to [page 29](#) for selection.)

- To disconnect the inverter from the power supply at activation of a protective function or at malfunctioning of the driving system (emergency stop, etc.).

For example, an MC prevents overheat or burnout of the brake resistor when heat capacity of the resistor is insufficient or brake regenerative transistor is damaged with short while connecting an optional brake resistor.

- To prevent any accident due to an automatic restart at power restoration after an inverter stop made by a power failure.
- To separate the inverter from the power supply to ensure safe maintenance and inspection work.

Use the inverter input current as a reference for selection of an MC to perform an emergency stop during operation, and select the MC conforming to JEM 1038-AC-3 class rated operational current.

#### NOTE

- Since repeated inrush currents at power ON will shorten the life of the converter circuit (switching life is about 1,000,000 times), frequent starts and stops of the magnetic contactor must be avoided. Turn ON or OFF the start (STF/STR) signal for the inverter start control to run or stop the inverter.

- Inverter start/stop circuit example

As shown in the following figure, always use the start signal (turn ON or OFF the STF/STR signal) to make a start or stop.

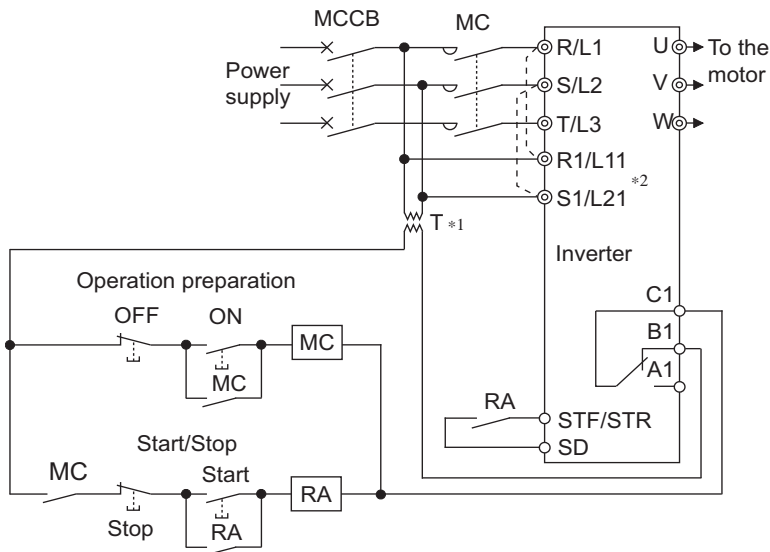

\*1 When the power supply is 400 V class, install a stepdown transformer.

\*2 To hold the Fault signal when the inverter's protective circuit is activated, connect the control circuit power supply terminals R1/L11 and S1/L21 to the input side of the MC. Before connection, remove jumpers across terminals R/L1 and R1/L11 and across terminals S/L2 and S1/L21. (Refer to [page 77](#) for removal of the jumper.)

### ◆ Handling of the magnetic contactor on the inverter's output side

Switch the magnetic contactor between the inverter and motor only when both the inverter and motor are at a stop. When the magnetic contactor is turned ON while the inverter is operating, overcurrent protection of the inverter and such will activate. When the magnetic contactor is provided to switch to a commercial power supply, for example, it is recommended to use the electronic bypass function **Pr.135 to Pr.139** (refer to [page 563](#)). (The commercial power supply operation is not available with Vector control dedicated motors (SF-V5RU, SF-THY) nor with PM motors.)

## ◆ Handling of the manual contactor on the inverter's output side

A PM motor is a synchronous motor with high-performance magnets embedded inside. High-voltage is generated at the motor terminals while the motor is running even after the inverter power is turned OFF. In an application where the PM motor is driven by the load even after the inverter is powered OFF, a low-voltage manual contactor must be connected at the inverter's output side.

### NOTE

- Before wiring or inspection for a PM motor, confirm that the PM motor is stopped. In an application, such as fan and blower, where the motor is driven by the load, a low-voltage manual contactor must be connected at the inverter's output side, and wiring and inspection must be performed while the contactor is open. Otherwise you may get an electric shock.
- Do not open or close the contactor while the inverter is running (outputting).

## 3.5 Countermeasures against deterioration of the 400 V class motor insulation

In the PWM type inverter, a surge voltage attributable to wiring constants is generated at the motor terminals. Especially in a 400 V class motor, the surge voltage may deteriorate the insulation. When the 400 V class motor is driven by the inverter, consider the following countermeasures:

### ◆ Countermeasures (with induction motor)

It is recommended to take one of the following countermeasures:

#### ■ Rectifying the motor insulation and limiting the PWM carrier frequency according to the wiring length

For the 400 V class motor, use an insulation-enhanced motor.

Specifically,

- Order a "400 V class inverter-driven insulation-enhanced motor".
- For the dedicated motor such as the constant-torque motor and low-vibration motor, use an "inverter-driven dedicated motor".
- Set **Pr.72 PWM frequency selection** as indicated below according to the wiring length.

	Wiring length		
	Shorter than 50 m	50 to 100 m	Longer than 100 m
<b>Pr.72 PWM frequency selection</b>	15 (14.5 kHz) or lower	9 (9 kHz) or lower	4 (4 kHz) or lower

#### ■ Suppressing the surge voltage on the inverter side

- For the FR-A840-01800(55K) or lower, connect the surge voltage suppression filter (FR-ASF-H/FR-BMF-H) to the inverter output side.
- For the FR-A840-02160(75K) or higher, connect the sine wave filter (MT-BSL/BSC) to the inverter output side.

### ◆ Countermeasures (with PM motor)

When the wiring length exceeds 50 m, set "9" (6 kHz) or less in **Pr.72 PWM frequency selection**.

#### NOTE

- For details on **Pr.72 PWM frequency selection**, refer to [page 356](#). (When using an optional sine wave filter (MT-BSL/BSC), set "25" (2.5 kHz) in **Pr.72**.)
- For details on the surge voltage suppression filter (FR-ASF-H/FR-BMF-H) and the sine wave filter (MT-BSL/BSC), refer to the Instruction Manual of each option.
- A surge voltage suppression filter (FR-ASF-H/FR-BMF-H) can be used under V/F control and Advanced magnetic flux vector control. A sine wave filter (MT-BSL/BSC) can be used under V/F control. Do not use the filters under different control methods.
- The carrier frequency is limited during PM sensorless vector control. (Refer to [page 356](#).)

## 3.6 Checklist before starting operation

The FR-A800 series inverter is a highly reliable product, but incorrect peripheral circuit making or operation/handling method may shorten the product life or damage the product. Before starting operation, always recheck the following points.

Checkpoint	Countermeasure	Refer to page	Check by user
Crimp terminals are insulated.	Use crimp terminals with insulation sleeves to wire the power supply and the motor.	—	
The wiring between the power supply (terminals R/L1, S/L2, T/L3) and the motor (terminals U, V, W) is correct.	Application of power to the output terminals (U, V, W) of the inverter will damage the inverter. Never perform such wiring.	55	
No wire offcuts are left from the time of wiring.	Wire offcuts can cause a fault, failure, or malfunction. Always keep the inverter clean. When drilling mounting holes in an enclosure etc., take caution not to allow chips and other foreign matter to enter the inverter.	—	
The main circuit cable gauge is correctly selected.	Use an appropriate cable gauge to suppress the voltage drop to 2% or less. If the wiring distance is long between the inverter and motor, a voltage drop in the main circuit will cause the motor torque to decrease especially during the output of a low frequency.	57	
The total wiring length is within the specified length.	Keep the total wiring length within the specified length. In long distance wiring, charging currents due to stray capacitance in the wiring may degrade the fast-response current limit operation or cause the equipment on the inverter's output side to malfunction. Pay attention to the total wiring length.	57	
Countermeasures are taken against EMI.	The input/output (main circuit) of the inverter includes high frequency components, which may interfere with the communication devices (such as AM radios) used near the inverter. In such case, enable the EMC filter (turn ON the EMC filter ON/OFF connector) to minimize interference.	120	
On the inverter's output side, there is no power factor correction capacitor, surge suppressor, or radio noise filter installed.	Doing so will shut off the inverter output or damage the capacitor or surge suppressor. If any of the above devices is connected, immediately remove it.	—	
When performing an inspection or rewiring on the product that has been energized, the operator has waited long enough after shutting off the power supply.	For a short time after the power-OFF, a high voltage remains in the smoothing capacitor, and it is dangerous. Before performing an inspection or rewiring, wait 10 minutes or longer after the power supply turns OFF, then confirm that the voltage across the main circuit terminals P/+ and N/- of the inverter is low enough using a digital multimeter, etc.	—	
The inverter's output side has no short circuit or ground fault occurring.	<ul style="list-style-type: none"> <li>• A short circuit or ground fault on the inverter's output side may damage the inverter module.</li> <li>• Fully check the insulation resistance of the circuit prior to inverter operation since repeated short circuits caused by peripheral circuit inadequacy or an earth (ground) fault caused by wiring inadequacy or reduced motor insulation resistance may damage the inverter module.</li> <li>• Fully check the to-earth (ground) insulation and phase-to-phase insulation of the inverter's output side before power-ON. Especially for an old motor or use in hostile atmosphere, securely check the motor insulation resistance, etc.</li> </ul>	—	
The circuit is not configured to use the inverter's input-side magnetic contactor to start/stop the inverter frequently.	Since repeated inrush currents at power ON will shorten the life of the converter circuit, frequent starts and stops of the magnetic contactor must be avoided. Turn ON or OFF the inverter's start (STF/STR) signal to run or stop the inverter.	128	
A mechanical brake is not connected to terminals P/+ and PR.	To terminals P/+ and PR, connect only an external brake resistor.	97	
The voltage applied to the inverter I/O signal circuits is within the specifications.	Application of a voltage higher than the permissible voltage to the inverter I/O signal circuits or opposite polarity may damage the I/O devices. Especially check the wiring to prevent the speed setting potentiometer from being connected incorrectly to short circuit terminals 10E and 5.	68	



Checkpoint	Countermeasure	Refer to page	Check by user
When using the electronic bypass operation, electrical and mechanical interlocks are provided between the electronic bypass contactors MC1 and MC2.	<p>When using a switching circuit as shown below, chattering due to misconfigured sequence or arc generated at switching may allow undesirable current to flow in and damage the inverter. Miswiring may also damage the inverter. (The commercial power supply operation is not available with Vector control dedicated motors (SF-V5RU, SF-THY) nor with PM motors.)</p> <p>If switching to the commercial power supply operation while a failure such as an output short circuit has occurred between the magnetic contactor MC2 and the motor, the damage may further spread. If a failure has occurred between the MC2 and the motor, a protection circuit such as using the OH signal input must be provided.</p>	—	
A countermeasure is provided for power restoration after a power failure.	If the machine must not be restarted when power is restored after a power failure, provide an MC on the inverter's input side and also make up a sequence which will not switch ON the start signal. If the start signal (start switch) remains ON after a power failure, the inverter will automatically restart as soon as the power is restored.	—	
For Vector control, the encoder is properly installed.	The encoder must be directly connected to a motor shaft without any backlash. (Real sensorless vector control or PM sensorless vector control do not require an encoder.)	87	
A magnetic contactor (MC) is installed on the inverter's input side.	<p>On the inverter's input side, connect an MC for the following purposes:</p> <ul style="list-style-type: none"> <li>• To disconnect the inverter from the power supply at activation of a protective function or at malfunctioning of the driving system (emergency stop, etc.).</li> <li>• To prevent any accident due to an automatic restart at power restoration after an inverter stop made by a power failure.</li> <li>• To separate the inverter from the power supply to ensure safe maintenance and inspection work.</li> </ul> <p>To use an MC to perform an emergency stop during operation, select the MC conforming to JEM 1038-AC-3 rated current for the inverter rated input current.</p>	128	
The magnetic contactor on the inverter's output side is properly handled.	Switch the magnetic contactor between the inverter and motor only when both the inverter and motor are at a stop.	128	
When using a PM motor, a low-voltage manual contactor is installed on the inverter's output side.	A PM motor is a synchronous motor with high-performance magnets embedded inside. High-voltage is generated at the motor terminals while the motor is running even after the inverter power is turned OFF. In an application, such as fan and blower, where the motor is driven by the load, a low-voltage manual contactor must be connected on the inverter's output side, and wiring and inspection must be performed while the contactor is open. Otherwise you may get an electric shock.	128	
An EMI countermeasure is provided for the frequency setting signals.	<p>If electromagnetic noise generated from the inverter causes the frequency setting signal to fluctuate and the motor rotation speed to be unstable when changing the motor speed with analog signals, the following countermeasures are effective:</p> <ul style="list-style-type: none"> <li>• Do not run the signal cables and power cables (inverter I/O cables) in parallel with each other and do not bundle them.</li> <li>• Run the signal cables as far away as possible from the power cables (inverter I/O cables).</li> <li>• Use shielded cables.</li> <li>• Install a data line filter to signal cable (example: ZCAT3035-1330 by TDK).</li> </ul>	118	
A countermeasure is provided for an overload operation.	When performing frequent starts/stops by the inverter, rise/fall in the temperature of the transistor element of the inverter will repeat due to a repeated flow of large current, shortening the life from thermal fatigue. Since thermal fatigue is related to the amount of current, the life can be increased by reducing current at locked condition, starting current, etc. Reducing current may extend the service life but may also cause torque shortage, which leads to a start failure. Adding a margin to the current can eliminate such a condition. For an induction motor, use an inverter of a higher capacity (up to two ranks). For a PM motor, use an inverter and PM motor of higher capacities.	—	
The specifications and rating match the system requirements.	Make sure that the specifications and rating match the system requirements.	826	

Checkpoint	Countermeasure	Refer to page	Check by user
Countermeasures are taken against electrical corrosion on the motor bearing.	<p>When a motor is driven by the inverter, axial voltage is generated on the motor shaft, which may cause electrical corrosion of the bearing in rare cases depending on the wiring, load, operating conditions of the motor or specific inverter settings (high carrier frequency and EMC filter ON). Contact your sales representative to take appropriate countermeasures for the motor. The following shows examples of countermeasures for the inverter.</p> <ul style="list-style-type: none"> <li>• Decrease the carrier frequency.</li> <li>• Turn OFF the EMC filter.</li> <li>• Provide a common mode choke<sup>*1</sup> on the output side of the inverter. (This is effective regardless of the EMC filter ON/OFF connector setting.)</li> </ul>	—	

\*1 Recommended common mode choke: FT-3KM F series FINEMET® common mode choke cores manufactured by Hitachi Metals, Ltd. FINEMET is a registered trademark of Hitachi Metals, Ltd.

## 3.7 Failsafe system which uses the inverter

When a fault is detected by the protective function, the protective function activates and outputs the Fault signal. However, the Fault signal may not be output at an inverter's fault occurrence when the detection circuit or output circuit fails, etc. Although Mitsubishi assures the best quality products, provide an interlock which uses inverter status output signals to prevent accidents such as damage to the machine when the inverter fails for some reason. Also at the same time consider the system configuration where a failsafe from outside the inverter, without using the inverter, is enabled even if the inverter fails.

### ◆ Interlock method which uses the inverter status output signals

By combining the inverter output signals to provide an interlock as shown below, an inverter failure can be detected.

No.	Interlock method	Check method	Used signals	Refer to page
a	Inverter protective function operation	Operation check of an alarm contact. Circuit error detection by negative logic.	Fault (ALM) signal	483
b	Inverter operating status	Operation ready signal check.	Inverter operation ready (RY) signal	479
c	Inverter running status	Logic check of the start signal and running signal.	Start (STF or STR) signal Inverter running (RUN) signal	479, 722
d	Inverter running status	Logic check of the start signal and output current.	Start (STF or STR) signal Output current detection (Y12) signal	487, 722

- When using various signals, assign the functions to **Pr.190 to Pr.196 (Output terminal function selection)** referring to the table on the left.

Output signal	Pr.190 to Pr.196 setting	
	Positive logic	Negative logic
ALM	99	199
RY	11	111
RUN	0	100
Y12	12	112

#### NOTE

- Changing the terminal assignment using **Pr.190 to Pr.196 (Output terminal function selection)** may affect the other functions. Set parameters after confirming the function of each terminal.

### ■ Checking by using the Fault signal output from the inverter... (a)

When the inverter's protective function activates and the inverter output is stopped, the Fault (ALM) signal is output. (The ALM signal is assigned to terminal A1B1C1 in the initial setting). With this signal, check that the inverter operates properly. In addition, negative logic can be set. (ON when the inverter is normal, OFF when the fault occurs.)

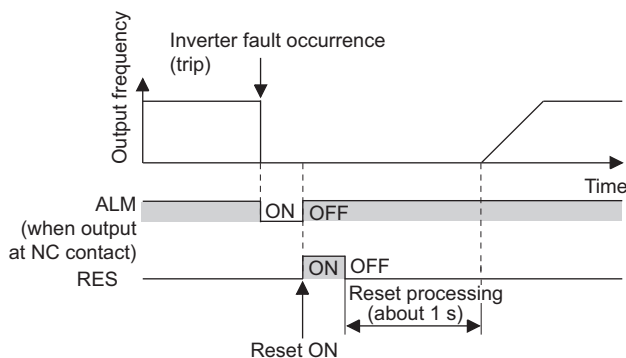

### ■ Checking the inverter operating status by using the Inverter operation ready signal output from the inverter ... (b)

The Inverter operation ready (RY) signal is output when the inverter power is ON and the inverter becomes operative. Check if the RY signal is output after powering ON the inverter.

### ■ Checking the inverter operating status by using the start signal input to the inverter and the Inverter running signal output from the inverter ... (c)

The Inverter running (RUN) signal is output when the inverter is running. (The RUN signal is assigned to terminal RUN in the initial setting.) Check if the RUN signal is output while a start signal (the STF/STR signal for forward/reverse rotation command) is input to the inverter. Even after the start signal is turned OFF, the RUN signal is kept output until the inverter makes the motor to decelerate and to stop. For the logic check, configure a sequence considering the inverter's deceleration time.

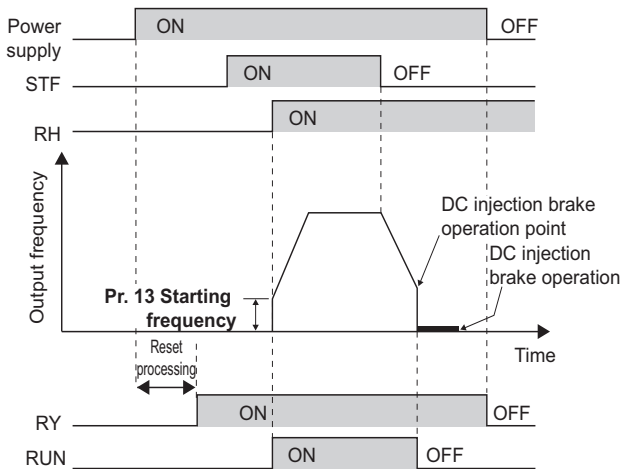

### ■ Checking the motor operating status by using the start signal input to the inverter and the Output current detection signal output from the inverter ... (d)

The Output current detection (Y12) signal is output when the inverter operates and currents flows into the motor. Check if the Y12 signal is output while a start signal (the STF/STR signal for forward/reverse rotation command) is input to the inverter. The Y12 signal is initially set to be output at 150% inverter rated current. Adjust the level to around 20% using no load current of the motor as reference with **Pr.150 Output current detection level**.

Like the Inverter running (RUN) signal, even after the start signal is turned OFF, the Y12 signal is kept output until the inverter stops the output to a decelerating motor. For the logic check, configure a sequence considering the inverter's deceleration time.

### ◆ Backup method which does not use the inverter

Even if the interlock is provided by the inverter status signal, enough failsafe is not ensured depending on the failure status of the inverter itself. For example, if an inverter CPU fails in a system interlocked with the inverter's Fault, start, and RUN signals, no Fault signals will be output and the RUN signal will be kept ON because the inverter CPU is down.

Provide a speed detector to detect the motor speed and current detector to detect the motor current, and consider the backup system such as performing a check as follows according to the level of importance of the system.

### ■ Start signal and actual operation check

Check the motor running and motor current while the start signal is input to the inverter by comparing the start signal to the inverter and detected speed of the speed detector or detected current of the current detector. Note that the current is flowing through the motor while the motor coasts to stop, even after the inverter's start signal is turned OFF. For the logic check, configure a sequence considering the inverter's deceleration time. In addition, it is recommended to check the three-phase current when using the current detector.

### ■ Command speed and actual operation check

Check for a gap between the actual speed and commanded speed by comparing the inverter's speed command and the speed detected by the speed detector.

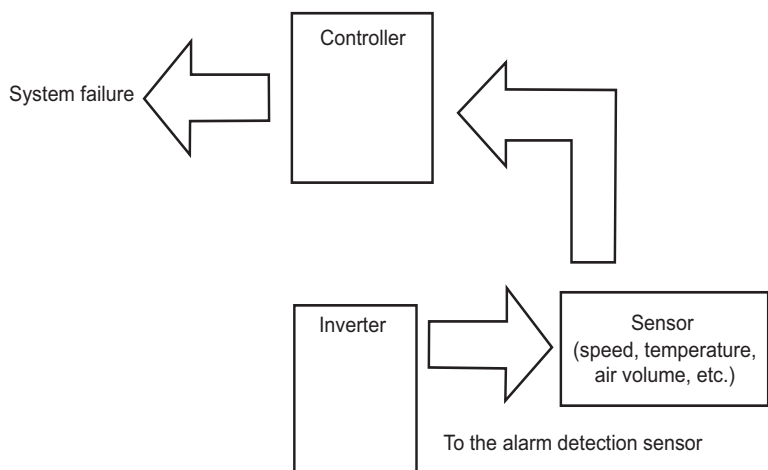

# CHAPTER 4 BASIC OPERATION

4.1	Operation panel (FR-DU08).....	138
4.2	Monitoring the inverter .....	143
4.3	Easy setting of the inverter operation mode .....	144
4.4	Frequently-used parameters (simple mode parameters).....	146
4.5	Basic operation procedure (PU operation) .....	149
4.6	Basic operation procedure (External operation) .....	155
4.7	Basic operation procedure (JOG operation).....	162

# 4 BASIC OPERATION









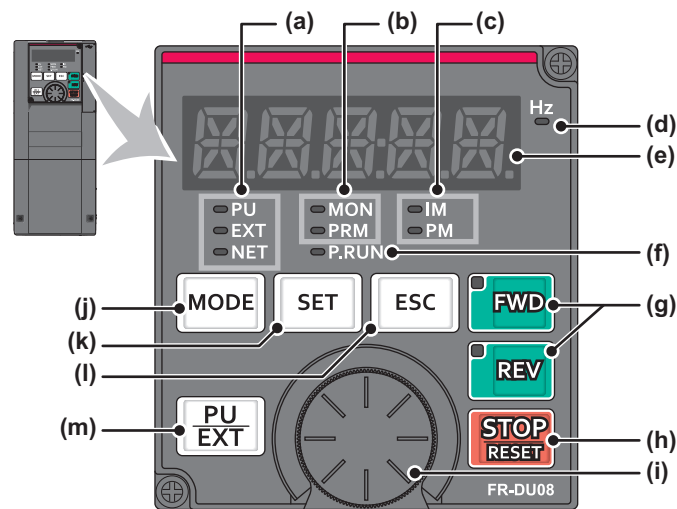





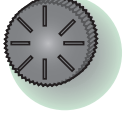

This chapter explains the basic operation of this product.  
Always read the instructions before use.

## 4.1 Operation panel (FR-DU08)

### 4.1.1 Components of the operation panel (FR-DU08)

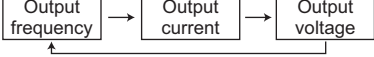
To mount the operation panel (FR-DU08) on the enclosure surface, refer to [page 84](#).



No.	Appearance	Name	Description
(a)		Inverter operation mode LED indicator	PU: ON when the inverter is in the PU operation mode. EXT: ON when the inverter is in the External operation mode. (ON when the inverter in the initial setting is powered ON.) NET: ON when the inverter is in the Network operation mode. PU and EXT: ON when the inverter is in the External/PU combined operation mode 1 or 2.
(b)		Operation panel mode LED indicator	MON: ON when the operation panel is in the monitor mode. Quickly blinks twice intermittently while the protective function is activated. Slowly blinks when the display-off function of the operation panel is valid. PRM: ON when the operation panel is in the parameter setting mode.
(c)		Controlled motor type LED indicator	IM: ON when the inverter is set to control the induction motor. PM: ON when the inverter is set to control the PM motor. The indicator blinks during test operation.
(d)		Frequency unit LED indicator	ON when the actual frequency is monitored. (Blinks when the set frequency is monitored.)
(e)		Monitor (5-digit LED)	Shows a numeric value (readout) of a monitor item such as the frequency or a parameter number. (The monitor item can be changed according to the settings of <b>Pr.52, Pr.774 to Pr.776.</b> )
(f)		PLC function LED indicator	ON when the PLC function of the inverter is valid.
(g)		FWD key, REV key	FWD key: Starts forward rotation operation. Its LED is ON during forward rotation operation. REV key: Starts reverse rotation operation. Its LED is ON during reverse rotation operation. Either LED blinks under the following conditions. <ul style="list-style-type: none"> <li>• When the frequency command is not given even if the forward/reverse command is given.</li> <li>• When the frequency command is equal to the starting frequency or lower.</li> <li>• When the MRS signal is being input.</li> </ul>
(h)		STOP/RESET key	Stops the operation commands. Used to reset the inverter when the protective function is activated.
(i)		Setting dial	The setting dial of the Mitsubishi Electric inverters. Turn the setting dial to change the setting of frequency or parameter, etc. Press the setting dial to perform the following operations: <ul style="list-style-type: none"> <li>• To display a set frequency on the LED display in the monitor mode. (The monitor item shown on the display can be changed by using <b>Pr.992.</b>)</li> <li>• To display the present setting during calibration.</li> <li>• To display a fault record number in the fault history mode.</li> </ul>
(j)		MODE key	Switches the operation panel to a different mode. The easy setting of the inverter operation mode is enabled by pressing this key simultaneously with  . Every key on the operation panel becomes inoperable by holding this key for 2 seconds. The key inoperable function is invalid when <b>Pr.161 = "0 (initial setting)"</b> . (Refer to <a href="#">page 341.</a> )
(k)		SET key	Confirms each selection. When this key is pressed during inverter operation, the monitor item changes. (The monitor item on each screen can be changed according to the settings of <b>Pr.52, Pr.774 to Pr.776.</b> ) <div style="float: right; text-align: center;"> <p>Initial setting in the monitor mode</p>  <pre> graph LR     A[Output frequency] --&gt; B[Output current]     B --&gt; C[Output voltage] </pre> </div>
(l)		ESC key	Goes back to the previous display. Holding this key for a longer time changes the display back to the monitor mode.
(m)		PU/EXT key	Switches between the PU operation mode, the PUJOG operation mode, and the External operation mode. The easy setting of the inverter operation mode is enabled by pressing this key simultaneously with  . Also cancels the PU stop warning.



## 4.1.2 Basic operation of the operation panel

### ◆ Basic operation

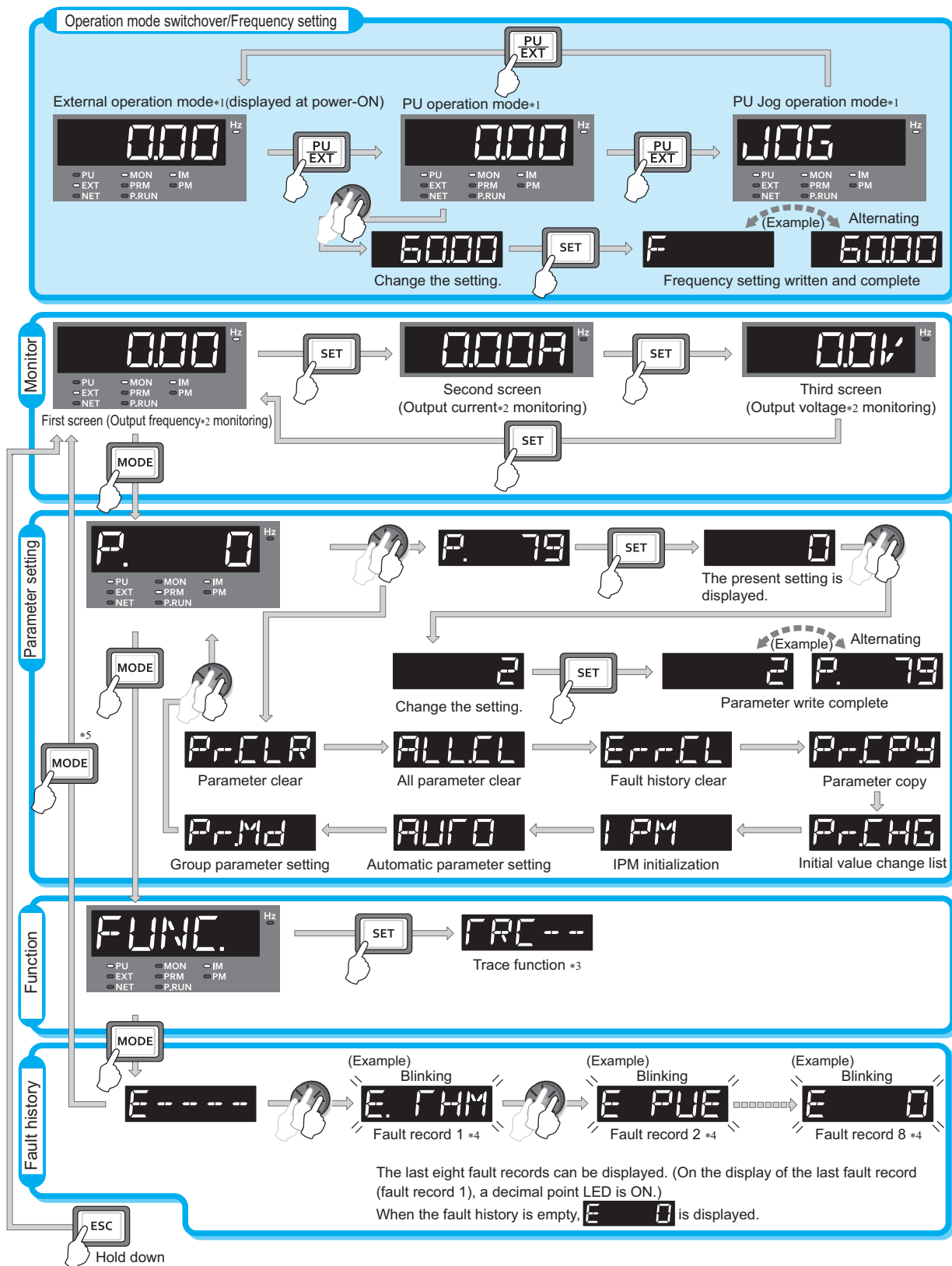

\*1 For details on operation modes, refer to [page 389](#).

\*2 The monitor item can be changed. (Refer to [page 446](#).)

\*3 For details on the trace function, refer to [page 649](#).

\*4 For details on the fault history, refer to [page 779](#).

\*5 The USB memory mode indication appears while a USB memory device is connected. (Refer to [page 85](#).)

## ◆ Parameter setting mode

In the parameter setting mode, inverter functions (parameters) are set.

The following table explains the indications in the parameter setting mode.

Operation panel indication	Function name	Description	Refer to page
P.	Parameter setting mode	Under this mode, the set value of the displayed parameter number is read or changed.	142
PrCLR	Parameter clear	Clears and resets parameter settings to the initial values. Calibration parameters and offline auto tuning parameters are not cleared. For details on the uncleared parameters, refer to <a href="#">page 864</a> .	743
ALLCL	All parameter clear	Clears and resets parameter settings to the initial values. Calibration parameters and the offline auto tuning parameters are also cleared. For details on the uncleared parameters, refer to <a href="#">page 864</a> .	743
ErrCL	Fault history clear	Deletes the fault history.	774
PrCPY	Parameter copy	Copies the parameter settings saved in the inverter to the operation panel. The parameters copied to the operation panel can be also copied to other inverters.	744
PrCHG	Initial value change list	Identifies the parameters that have been changed from their initial settings.	751
IPM	IPM initialization	Changes the parameters to the settings required to drive an IPM motor (MM-CF) as a batch. Also changes the parameters back to the settings required to drive an induction motor.	230
AUTO	Automatic parameter setting	Changes parameter settings as a batch. The target parameters include communication parameters for the Mitsubishi Electric human machine interface (GOT) connection and the parameters for the rated frequency settings of 50 Hz/60 Hz.	350
PrMd	Group parameter setting	Displays parameter numbers by function groups.	201

### 4.1.3 Digital characters and their corresponding printed equivalents











Digital characters displayed on the operation panel display are as follows.

0	1	2	3	4	5	6	7	8	9	A	B(b)	C	c	D(d)
0	1	2	3	4	5	6	7	8	9	A	b	C	c	d
E(e)	F(f)	G(g)	H(h)	I(i)	J(j)	K(k)	L(l)	M(m)	N	n	O	o	P(p)	Q(q)
E	F	G	H	I	J	K	L	M	N	n	O	o	P	Q
R	r	S(s)	T(t)	U	u	V	v	W	w	X(x)	Y(y)	Z(z)		
R	r	S	T	U	u	V	v	W	w	X	Y	Z		

## 4.1.4 Changing the parameter setting value

The following shows the procedure to change the setting of **Pr.1 Maximum frequency**.

### Operating procedure

1. Turning ON the power of the inverter  
The operation panel is in the monitor mode.
2. Changing the operation mode  
Press  to choose the PU operation mode. [PU] indicator turns ON.
3. Selecting the parameter setting mode  
Press  to choose the parameter setting mode. (The parameter number read previously appears.)
4. Selecting the parameter  
Turn  until "P. 1" (**Pr.1**) appears. Press  to read the present set value.  
" 12000" (initial value) appears.
5. Changing the setting value  
Turn  to change the set value to "6000". Press  to confirm the selection. " 6000" and "P. 1" are displayed alternately.
  - Turn  to read another parameter.
  - Press  to show the setting again on the LCD display.
  - Press  twice to show the next parameter.
  - Press  three times to return the monitor display to the indication of the frequency.

### NOTE

- If a parameter write condition is not satisfied, a parameter write error appears on the LCD display. (Refer to [page 779](#).)

Error indication	Description
Er-1	Parameter write error
Er-2	Write error during operation
Er-3	Calibration error
Er-4	Mode designation error

- When **Pr.77 Parameter write selection** = "0 (initial setting)," the parameter setting change is only available while the inverter is stopped and under the PU operation mode. To enable the parameter setting change while the inverter is running or under the operation mode other than PU operation mode, change the **Pr.77** setting. (Refer to [page 345](#).)

## 4.2 Monitoring the inverter



### 4.2.1 Monitoring of output current and output voltage

#### Point

- Press  on the operation panel in the monitor mode to switch the monitor item between output frequency, output current, and output voltage.

4

#### Operating procedure

1. Press  during inverter operation to monitor the output frequency. [Hz] indicator turns ON.
2. Press  to monitor the output current. This operation is valid under any operation mode of the inverter and whether the inverter is running or at a stop. The unit of current "A" appears.
3. Press  to monitor the output voltage. The unit of voltage "V" appears.

#### NOTE

- Other monitor item, such as output power or set frequency, is also available. Use **Pr.52 Operation panel main monitor selection** or **Pr.774 Operation panel monitor selection 1 to Pr.776 Operation panel monitor selection 3** to change the setting. (Refer to [page 446](#).)

### 4.2.2 First priority monitor screen

The first priority monitor screen, which is displayed first when the operation panel becomes in the monitor mode, is selectable.

To set it, press  for a while when the desired monitor item is displayed on a monitor screen.

The following show the procedure to set the monitor screen displaying the output current as the first priority monitor screen.

#### Operating procedure

1. Change the mode of the operation panel to the monitor mode, and switch the monitor screen to the one on which the output current can be monitored.
2. Press  for a while (1 second). The output current monitor screen is set as the first priority monitor screen.
3. When the operation panel is in the monitor mode next time, the output current monitored value is displayed first.

#### NOTE

- Use **Pr.52 Operation panel main monitor selection** or **Pr.774 Operation panel monitor selection 1 to Pr.776 Operation panel monitor selection 3** to change the monitor item. (Refer to [page 446](#).)

### 4.2.3 Displaying the set frequency

To display the present set frequency, change the mode of the operation panel to the monitor mode and press the setting dial



() while the inverter runs in the PU operation mode or in the External/PU combined operation mode 1 (**Pr.79 Operation mode selection = "3"**).

#### NOTE

- Use **Pr.992 Operation panel setting dial push monitor selection** to change the item to be displayed. (Refer to [page 446](#).)

# 4.3 Easy setting of the inverter operation mode

The operation mode suitable for start and speed command combinations can be set easily using **Pr.79 Operation mode selection**.

The following shows the procedure to operate with the external start command (STF/STR) and the frequency command by using .

## Operating procedure





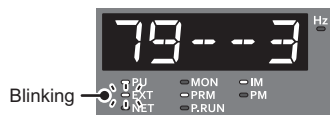

1. Press  and  for 0.5 seconds.



2. Turn  until "79-- --3" (External/PU combined operation mode 1) appears. (For other settings, refer to the following table.)

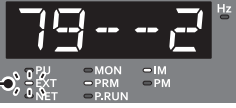
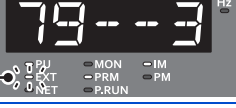

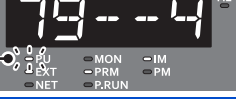



3. Press  to confirm the selection. External/PU combined operation mode 1 (**Pr.79** = "3") is set.

Operation panel indication	Operation method		Operation mode
	Start command	Frequency command	
		 *1	PU operation mode
	External (STF, STR)	Analog voltage input	External operation mode
	External (STF, STR)	 *1	External/PU combined operation mode 1
		Analog voltage input	External/PU combined operation mode 2

\*1 To use the setting dial as a potentiometer, refer to [page 341](#).

**NOTE**

- "Er 1" appears if the **Pr.79** setting is tried to be changed while the inverter is set that only the parameters registered in the user group are read (**Pr.160** = "1") but **Pr.79** is not included in the user group.
- "Er 2" appears if a setting change is attempted during inverter operation. Turn OFF the start command ( / , or STF/STR signal).
- If  is pressed before pressing , the easy setting is terminated and the operation panel returns to the monitor mode. If the easy setting is terminated while **Pr.79** = "0 (initial value)", check the inverter operation mode because the inverter may switch its operation mode between the PU operation mode and the External operation mode.
- Reset by pressing  is enabled.
- The priorities of the frequency commands while **Pr.79** = "3" are "Multi-speed operation (RL/RM/RH/REX) > PID control (X14) > terminal 4 analog input (AU) > digital input from the operation panel".

## 4.4 Frequently-used parameters (simple mode parameters)

---

Parameters that are frequently used for the FR-A800 series are grouped as simple mode parameters.

When **Pr.160 User group read selection** = "9999", only the simple mode parameters are displayed on the operation panel.

This section explains the simple mode parameters.

### 4.4.1 Simple mode parameter list

For simple variable-speed operation of the inverter, the initial values of the parameters may be used as they are. Set the necessary parameters to meet the load and operational specifications. Parameter's setting, change and check can be made on the operation panel (FR-DU08).

#### Point

- **Pr.160 User group read selection** can narrow down the displayed parameters to only the simple mode parameters. (In the initial setting, all parameters are displayed.) Set **Pr.160 User group read selection** as required. (To change the parameter setting, refer to [page 142](#).)

Pr.160 setting	Description
9999	Only simple mode parameters are displayed.
0 (initial value)	All parameters (simple mode parameters and extended parameters) are displayed.
1	Only parameters registered in user groups are displayed.

## ◆ Simple mode parameter

Pr.	Pr. group	Name	Increment	Initial value <sup>*11</sup>		Range	Application	Refer to page
				FM	CA			
0	G000	Torque boost	0.1%	6% <sup>*1</sup>		0 to 30%	Set this parameter to obtain a higher starting torque under V/F control. Also set this when a loaded motor cannot be driven, the warning "OL" occurs, and the inverter output is shut off with the fault indication "E.OC1".	706
				4% <sup>*2</sup>				
				3% <sup>*3</sup>				
				2% <sup>*4</sup>				
				1% <sup>*5</sup>				
1	H400	Maximum frequency	0.01 Hz	120 Hz <sup>*6</sup>		0 to 120 Hz	Set the upper limit for the output frequency.	428
				60 Hz <sup>*7</sup>				
2	H401	Minimum frequency	0.01 Hz	0 Hz		0 to 120 Hz	Set the lower limit for the output frequency.	
3	G001	Base frequency	0.01 Hz	60 Hz	50 Hz	0 to 590 Hz	Set this parameter when the rated motor frequency is 50 Hz. Check the rating plate of the motor.	707
4	D301	Multi-speed setting (high speed)	0.01 Hz	60 Hz	50 Hz	0 to 590 Hz	Pre-set the speeds that will be switched among by terminals.	151, 156, 411
5	D302	Multi-speed setting (middle speed)	0.01 Hz	30 Hz		0 to 590 Hz		
6	D303	Multi-speed setting (low speed)	0.01 Hz	10 Hz		0 to 590 Hz		
7	F010	Acceleration time	0.1 s	5s <sup>*9</sup>		0 to 3600 s	Sets the acceleration time.	367
				15s <sup>*10</sup>				
8	F011	Deceleration time	0.1 s	5s <sup>*9</sup>		0 to 3600 s	Sets the deceleration time.	
				15s <sup>*10</sup>				
9	H000 C103	Electronic thermal O/L relay	0.01 A <sup>*6</sup> 0.1 A <sup>*7</sup>	Inverter rated current <sup>*8</sup>		0 to 500 A <sup>*6</sup>	Protects the motor from heat. Set the rated motor current.	415
						0 to 3600 A <sup>*7</sup>		
79	D000	Operation mode selection	1	0		0 to 4, 6, 7	Select the start and frequency command sources.	389
125	T022	Terminal 2 frequency setting gain frequency	0.01 Hz	60 Hz	50 Hz	0 to 590 Hz	Allows the frequency at the maximum potentiometer setting (5 V in the initial setting) to be changed.	159, 505
126	T042	Terminal 4 frequency setting gain frequency	0.01 Hz	60 Hz	50 Hz	0 to 590 Hz	Allows the frequency at the maximum current input (20 mA in the initial setting) to be changed.	161, 505
160	E440	User group read selection	1	0		0, 1, 9999	This function restricts the parameters that are read by the operation panel and parameter unit.	354
998	E430	PM parameter initialization	1	0		0, 3003, 3103, 8009, 8109, 9009, 9109	Selects the PM sensorless vector control and set the parameters that are required to drive a PM motor.	230
999	E431	Automatic parameter setting	1	9999		1, 2, 10, 11, 12, 13, 20, 21, 9999	Changes parameter settings as a batch. The target parameters include communication parameters for the Mitsubishi Electric human machine interface (GOT) connection and the parameters for the rated frequency settings of 50/60 Hz.	350

\*1 The initial value for the FR-A820-00077(0.75K) or lower and FR-A840-00038(0.75K) or lower.

\*2 The initial value for the FR-A820-00105(1.5K) to FR-A820-00250(3.7K), FR-A840-00052(1.5K) to FR-A840-00126(3.7K).

\*3 The initial values for the FR-A820-00340(5.5K), FR-A820-00490(7.5K), FR-A840-00170(5.5K), FR-A840-00250(7.5K).

\*4 The initial value for the FR-A820-00630(11K) to FR-A820-03160(55K), FR-A840-00310(11K) to FR-A840-01800(55K).

\*5 The initial value for the FR-A820-03800(75K) or higher and FR-A840-02160(75K) and higher.

\*6 For the FR-A820-03160(55K) or lower, and FR-A840-01800(55K) or lower.

\*7 For the FR-A820-03800(75K) or higher, and FR-A840-02160(75K) or higher.

\*8 The initial value for the FR-A820-00077(0.75K) or lower and FR-A840-00038(0.75K) or lower is set to the 85% of the inverter rated current.

\*9 The initial value for the FR-A820-00490(7.5K) or lower and FR-A840-00250(7.5K) or lower.

\*10 Initial value for the FR-A820-00630(11K) or higher and FR-A840-00310(11K) and higher.

\*11 The initial value in "FM" column is for the FM-type inverter that has terminal FM, and that in "CA" column is for the CA-type inverter that has terminal CA.



## ◆ Parameters for the CC-Link IE Field Network communication (FR-A800-GF)

Pr.	Pr. group	Name	Increment	Initial value	Range	Application	Refer to page
313	M410	DO0 output selection	1	9999	0 to 8, 10 to 20, 22, 25 to 28, 30 to 36, 38 to 57, 60, 61, 63, 64, 68, 70, 79, 80, 84 to 99, 100 to 108, 110 to 116, 120, 122, 125 to 128, 130 to 136, 138, to 157, 160, 161, 163, 164, 168, 170, 179, 180, 184 to 199, 200 to 208, 300 to 308, 9999	Assign signals to the remote registers RX10 to RX12.	473, 758
314	M411	DO1 output selection	1	9999			
315	M412	DO2 output selection	1	9999			
349	—	Communication reset selection/ Ready bit status selection	1	0	0 (100)	Enables the error reset function in any operation mode.	663
					1 (101)	Enables the error reset function only in the Network operation mode.	
	N010	Communication reset selection			0	Enables the error reset function in any operation mode.	
					1	Enables the error reset function only in the Network operation mode.	
434	N110	Network number (CC-Link IE)	1	0	0 to 255	Enter the network number of the inverter.	752
435	N111	Station number (CC-Link IE)	1	0	0 to 255	Enter the station number of the inverter.	
500	N011	Communication error execution waiting time	0.1s	0 s	0 to 999.8 s	Set the time from when the communication line error occurs until the inverter starts the operation for the communication error	663
501	N012	Communication error occurrence count display	1	0	0	Displays the communication error occurrence count	
502	N013	Stop mode selection at communication error	1	0	0 to 4	Set the operations when the communication line error occurs and when the communication line error is removed.	
541	N100	Frequency command sign selection	1	0	0	Signed frequency command value	
					1	Unsigned frequency command value	
779	N014	Operation frequency during communication error	0.01 Hz.	9999	0 to 590 Hz	Set the frequency for the operation when a communication error occurs.	663
					9999	The motor runs at the frequency used before the communication error.	

### NOTE

- When **Pr.160** in the FR-A800-GF is set to "9999", the parameters for the CC-Link IE Field Network communication, as well as the simple mode parameters, are displayed.

# 4.5 Basic operation procedure (PU operation)

Select a method to give the frequency command from the list below, and refer to the specified page for its procedure.

Method to give the frequency command	Refer to page
Setting the frequency on the operation panel in the frequency setting mode	149
Give commands by turning the setting dial like a potentiometer	150
Give commands by turning ON/OFF switches wired to inverter's terminals (multi-speed setting)	151
Setting the frequency by inputting voltage signals	152
Setting the frequency by inputting current signals	153

## 4.5.1 Setting the frequency on the operation panel (example: operating at 30 Hz)

### Point

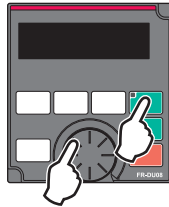

- Use the operation panel (FR-DU08) to give a start command and a frequency command. (PU operation)

Operation panel (FR-DU08)



The following shows the procedure to operate at 30 Hz.



### Operating procedure

- Turning ON the power of the inverter  
The operation panel is in the monitor mode.
- Changing the operation mode  
Press **PU EXT** to choose the PU operation mode. [PU] indicator turns ON.
- Setting the frequency  
Turn  until the target frequency "3000" (30.00 Hz) appears. The indication blinks for about five seconds.  
While the indication is flashing, press **SET** to confirm the selection for the frequency. "F" and "3000" are displayed alternately. After about three seconds of alternate display, the monitor display goes back to "000" (the indication of a monitored value).  
(If **SET** is not pressed during the flashing for about five seconds, the monitor display goes back to "000" (0.00 Hz). In that case, turn  again and set the frequency.)
- Start → acceleration → constant speed  
Press **FWD** or **REV** to start running. The frequency value on the monitor increases according to the setting of **Pr.7 Acceleration time**, and "3000" (30.00 Hz) appears on the monitor.  
(To change the set frequency, return to step 3. The previously set frequency appears.)

## 5. Deceleration → stop

Press  to stop. The frequency value on the monitor decreases according to the setting of **Pr.8 Deceleration time**, the monitor displays "0.00" (0.00 Hz), and the motor stops rotating.

### NOTE

- To display the set frequency under PU operation mode or External/PU combined operation mode 1 (**Pr.79** = "3"), press .
- (Refer to [page 446](#).)
-  can also be used like a potentiometer to perform inverter operation. (Refer to [page 150](#).)

### Parameters referred to

**Pr.7 Acceleration time**, **Pr.8 Deceleration time**  [page 367](#)

**Pr.79 Operation mode selection**  [page 389](#)





## 4.5.2 Perform PU operation using the setting dial like a potentiometer

### Point

- Set **Pr.161 Frequency setting/key lock operation selection** = "1" (setting dial potentiometer).

The following shows the procedure to change the frequency from 0 Hz to 60 Hz during operation.

### Operating procedure

1. Turning ON the power of the inverter  
The operation panel is in the monitor mode.
2. Changing the operation mode  
Press  to choose the PU operation mode. [PU] indicator turns ON.
3. Changing the parameter setting  
Change **Pr.161** setting to "1". (To change the setting, refer to [page 142](#).)
4. Start  
Press  or  to start the inverter operation.
5. Setting the frequency  
Turn  until "60.00" appears. The value in the flashing indication is set as the value of a set frequency (The indication blinks for about five seconds).  needs not to be pressed.

### NOTE

- If the indication changes from the blink of "60.00" to the display of "0.00", **Pr.161 Frequency setting/key lock operation selection** may be set to a value other than "1".
- Simply turning  enables frequency setting whether the inverter is running or at a stop.
- The newly-set frequency is saved as the set frequency in EEPROM after 10 seconds.
- With the setting dial, the frequency can go up to the setting value of **Pr.1 Maximum frequency**. Check the **Pr.1 Maximum frequency** setting, and adjust the setting according to the application.

### Parameters referred to

**Pr.1 Maximum frequency**  [page 428](#)

**Pr.161 Frequency setting/key lock operation selection**  [page 341](#)

## 4.5.3 Setting the frequency with switches (multi-speed setting)

### Point

- Use **FWD** or **REV** on the operation panel (FR-DU08) to give a start command.
- Turn ON the RH, RM, or RL signal to give a frequency command (multi-speed setting).
- Set **Pr.79 Operation mode selection** = "4" (External/PU combination operation mode 2).

[Connection diagram]

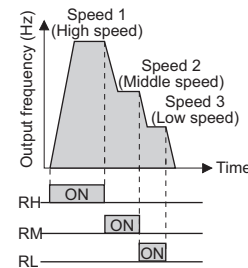
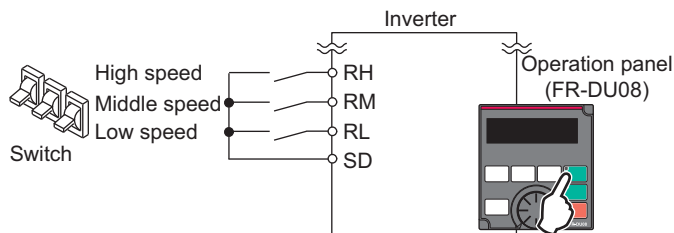

The following shows the procedure to operate at a low speed (10 Hz).

### Operating procedure

1. Turning ON the power of the inverter  
The operation panel is in the monitor mode.
2. Changing the operation mode  
Set "4" in **Pr.79**. [PU] and [EXT] indicators are ON. (To change the setting, refer to [page 144.](#))
3. Setting the frequency  
Turn ON the low-speed switch (RL signal).
4. Start → acceleration → constant speed  
Press **FWD** or **REV** to start running. The frequency value on the monitor increases according to the setting of **Pr.7 Acceleration time**, and "10.00" (10.00 Hz) appears on the monitor.
5. Deceleration → stop  
Press **STOP/RESET** to stop. The frequency value on the monitor decreases according to the setting of **Pr.8 Deceleration time**, the monitor displays "0.00" (0.00 Hz), and the motor stops rotating. Turn OFF the low-speed switch (RL signal).

### NOTE

- Initially, the high-speed switch (RH signal) is set to 60 Hz for the FM type inverter or 50 Hz for the CA type inverter. The middle-speed switch (RM signal) is set to 30 Hz, and the low-speed switch (RL signal) is set to 10 Hz. (To change the settings, use **Pr.4**, **Pr.5**, and **Pr.6**, respectively.)
- In the initial setting, if two or more speed switches (signals) are simultaneously turned ON, priority is given to the switch (signal) for the lower speed. For example, when both RH and RM signals turn ON, the RM signal (**Pr.5**) has the higher priority.
- Up to 15-speed switching operation can be performed.

### Parameters referred to

**Pr.4 to Pr.6 (multi-speed setting)** [page 411](#)  
**Pr.7 Acceleration time, Pr.8 Deceleration time** [page 367](#)  
**Pr.79 Operation mode selection** [page 389](#)

## 4.5.4 Setting the frequency using an analog signal (voltage input)

### Point

- Use **FWD** or **REV** on the operation panel (FR-DU08) to give a start command.
- Use the frequency setting potentiometer to give a frequency command (by connecting it to terminals 2 and 5 (voltage input)).
- Set **Pr.79 Operation mode selection** = "4" (External/PU combination operation mode 2).

[Connection diagram] (The inverter supplies 5 V power to the frequency setting potentiometer via terminal 10.)

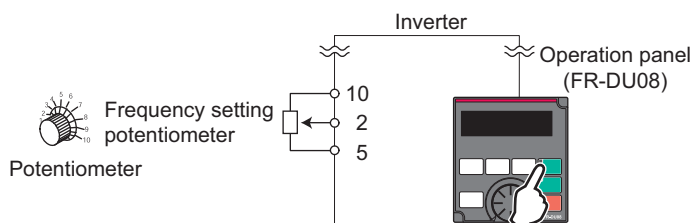

The following shows the procedure to operate at 60 Hz.

### Operating procedure

- 1.** Turning ON the power of the inverter  
The operation panel is in the monitor mode.
- 2.** Changing the operation mode  
Set "4" in **Pr.79**. [PU] and [EXT] indicators are ON. (To change the setting, refer to [page 142](#).)
- 3.** Start  
Press **FWD** or **REV**. [FWD] or [REV] indicator blinks as no frequency command is given.
- 4.** Acceleration → constant speed  
Turn the frequency setting potentiometer clockwise slowly to full. The frequency value on the monitor increases according to the setting of **Pr.7 Acceleration time**, and "60.00" (60.00 Hz) appears on the monitor.
- 5.** Deceleration  
Turn the frequency setting potentiometer counterclockwise slowly to full. The frequency value on the monitor decreases according to the setting of **Pr.8 Deceleration time**, the monitor displays "0.00" (0.00 Hz), and the motor stops rotating. [FWD] or [REV] indicator blinks.
- 6.** Stop  
Press **STOP/RESET**. [FWD] or [REV] indicator turns OFF.

### NOTE

- To change the frequency (60 Hz) at the maximum voltage input (initial value: 5 V), adjust **Pr.125 Terminal 2 frequency setting gain frequency**.
- To change the frequency (0 Hz) at the minimum voltage input (initial value: 0 V), adjust **the calibration parameter C2 Terminal 2 frequency setting bias frequency**.
- When terminal 10 is used, the maximum output frequency may fluctuate in a range of  $\pm 6$  Hz due to fluctuations in the output voltage ( $5\text{ V} \pm 0.5\text{ VDC}$ ). Use **Pr.125** or **Pr.C4** to adjust the output frequency at the maximum analog input as required. (Refer to [page 505](#).)
- When terminal 10E is used, the maximum output frequency may fluctuate (in a range of  $\pm 2$  to 3 Hz) due to fluctuations in the output voltage ( $10 \pm 0.4\text{ VDC}$ ). Use **Pr. 125** or **Pr. C4** to adjust the output frequency at the maximum analog input as required. (Refer to [page 505](#).)

### Parameters referred to

Pr.7 Acceleration time, Pr.8 Deceleration time [page 367](#)

Pr.79 Operation mode selection [page 389](#)

Pr.125 Terminal 2 frequency setting gain frequency [page 505](#)

C2(Pr.902) Terminal 2 frequency setting bias frequency [page 505](#)

## 4.5.5 Setting the frequency using an analog signal (current input)

### Point

- Use **FWD** or **REV** on the operation panel (FR-DU08) to give a start command.
- Use the current regulator which outputs 4 to 20 mA to give a frequency command (by connecting it across terminals 4 and 5 (current input)).
- Turn ON the AU signal.
- Set **Pr.79 Operation mode selection** = "4" (External/PU combination operation mode 2).

4

[Connection diagram]

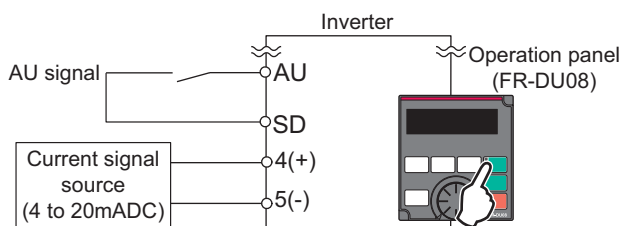

The following shows the procedure to operate at 60 Hz.

### Operating procedure

- 1.** Turning ON the power of the inverter  
The operation panel is in the monitor mode.
- 2.** Changing the operation mode  
Set "4" in **Pr.79**. [PU] and [EXT] indicators are ON. (To change the setting, refer to [page 142](#).)
- 3.** Selecting the input via terminal 4  
Turn ON the Terminal 4 input selection (AU) signal. Input via terminal 4 to the inverter is enabled.
- 4.** Start  
Press **FWD** or **REV**. [FWD] or [REV] indicator blinks as no frequency command is given.
- 5.** Acceleration → constant speed  
Input a current of 20 mA to the inverter from the regulator. The frequency value on the monitor increases according to the setting of **Pr.7 Acceleration time**, and "60.00" (60.00 Hz) appears on the monitor.
- 6.** Deceleration  
Input a current of 4 mA or less. The frequency value on the monitor decreases according to the setting of **Pr.8 Deceleration time**, the monitor displays "00.00" (0.00 Hz), and the motor stops rotating. [FWD] or [REV] indicator blinks.
- 7.** Stop  
Press **STOP RESET**. [FWD] or [REV] indicator turns OFF.

## NOTE

- **Pr.184 AU terminal function selection** must be set to "4 (initial value)" (AU signal).
- To change the frequency (60 Hz) at the maximum current input (initial value: 20 mA), adjust **Pr.126 Terminal 4 frequency setting gain frequency**.
- To change the frequency (0 Hz) at the minimum current input (initial value: 4 mA), adjust **the calibration parameter C5 Terminal 4 frequency setting bias frequency**.

### «Parameters referred to»

Pr.7 Acceleration time, Pr.8 Deceleration time [page 367](#)  
Pr.79 Operation mode selection [page 389](#)  
Pr.126 Terminal 4 frequency setting gain frequency [page 505](#)  
Pr.184 AU terminal function selection [page 521](#)  
C5(Pr.904) Terminal 4 frequency setting bias frequency [page 505](#)

## 4.6 Basic operation procedure (External operation)

Select a method to give the frequency command from the list below, and refer to the specified page for its procedure.

Method to give the frequency command	Refer to page
Setting the frequency on the operation panel in the frequency setting mode	155
Turning ON/OFF switches wired to inverter's terminals (multi-speed setting)	156
Setting the frequency by inputting voltage signals	157
Setting the frequency by inputting current signals	160

### 4.6.1 Setting the frequency on the operation panel

4

#### Point



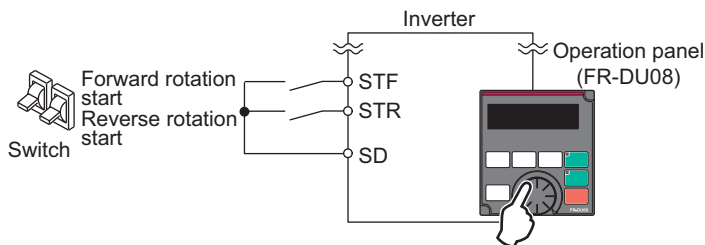

- Turn ON the STF/STR signal to give a start command.
- Use  on the operation panel (FR-DU08) to give a frequency command.
- Set **Pr.79** = "3" (External/PU combined operation mode 1).

[Connection diagram]





The following shows the procedure to operate at 30 Hz.

#### Operating procedure

1. Changing the operation mode  
Set "3" in **Pr.79**. [PU] and [EXT] indicators are ON. (To change the setting, refer to [page 142](#).)
2. Setting the frequency  
Turn  until the target frequency "3000" (30.00 Hz) appears. The indication blinks for about five seconds.  
While the indication is flashing, press  to confirm the selection for the frequency. "F" and "3000" are displayed alternately. After about three seconds of alternate display, the monitor display goes back to "000" (the indication of a monitored value). (If  is not pressed during the flashing for about five seconds, the monitor display goes back to "000" (0.00 Hz). In that case, turn  again and set the frequency.)
3. Start → acceleration → constant speed  
Turn ON the start switch (STF/STR signal). The frequency value on the monitor increases according to the setting of **Pr.7 Acceleration time**, and "3000" (30.00 Hz) appears on the monitor. [FWD] indicator is ON during the forward rotation, and [REV] indicator is ON during the reverse rotation. (To change the set frequency, return to step 2. The previously set frequency appears.)
4. Deceleration → stop  
Turn OFF the start switch (STF/STR signal). The frequency value on the monitor decreases according to the setting of **Pr.8 Deceleration time**, the monitor displays "000" (0.00 Hz), and the motor stops rotating.



## NOTE

- When both the forward rotation start switch (STF signal) and the reverse rotation start switch (STR signal) are turned ON, the motor cannot be started. If both are turned ON while the inverter is running, the inverter decelerates to a stop.
- **Pr.178 STF terminal function selection** must be set to "60" (or **Pr.179 STR terminal function selection** must be set to "61") (initial value).
- Setting **Pr.79 Operation mode selection** = "3" enables multi-speed operation.
- If  on the operation panel is pressed during the External operation, the inverter stops and the PU stop warning is activated ("PS" appears on the LCD display of the operation panel). To reset the PU stop warning, turn OFF the start switch (STF or STR signal), and then press  (refer to [page 338](#)).

## Parameters referred to

Pr.4 to Pr.6 (multi-speed setting) [page 411](#), Pr.7 Acceleration time, Pr.8 Deceleration time [page 367](#)  
 Pr.178 STF terminal function selection, Pr.179 STR terminal function selection [page 521](#)  
 Pr.79 Operation mode selection [page 389](#)

# 4.6.2 Setting the frequency and giving a start command with switches (multi-speed setting) (Pr.4 to Pr.6)

## Point

- Turn ON the STF/STR signal to give a start command.
- Turn ON the RH, RM, or RL signal to give a frequency command (multi-speed setting).

[Connection diagram]

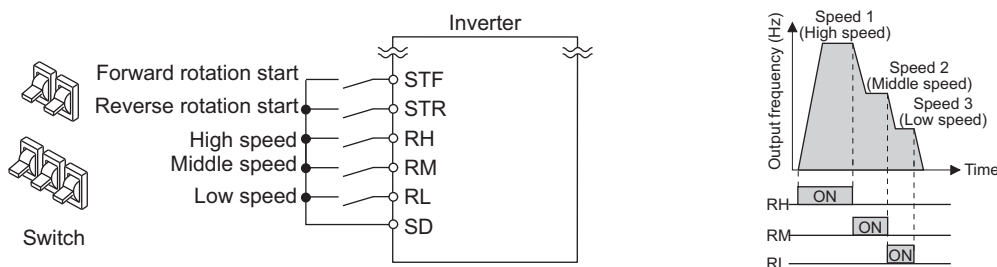

The following shows the procedure to operate at a high speed (60 Hz).

## Operating procedure

1. Turning ON the power of the inverter  
The operation panel is in the monitor mode.
2. Setting the frequency  
Turn ON the high-speed switch (RH signal).
3. Start → acceleration → constant speed  
Turn ON the start switch (STF/STR signal). The frequency value on the monitor increases according to the setting of **Pr.7 Acceleration time**, and "60.00" (60.00 Hz) appears on the monitor. [FWD] indicator is ON during the forward rotation, and [REV] indicator is ON during the reverse rotation. When the RM signal is turned ON, 30 Hz is displayed. When the RL signal is turned ON, 10 Hz is displayed.
4. Deceleration → stop  
Turn OFF the start switch (STF/STR signal). The frequency value on the monitor decreases according to the setting of **Pr.8 Deceleration time**, the monitor displays "00.00" (0.00 Hz), and the motor stops rotating. [FWD] or [REV] indicator turns OFF. Turn OFF the high-speed switch (RH signal).

## NOTE

- When both the forward rotation start switch (STF signal) and the reverse rotation start switch (STR signal) are turned ON, the motor cannot be started. If both are turned ON while the inverter is running, the inverter decelerates to a stop.
- Initially, the high-speed switch (RH signal) is set to 60 Hz for the FM type inverter or 50 Hz for the CA type inverter. The middle-speed switch (RM signal) is set to 30 Hz, and the low-speed switch (RL signal) is set to 10 Hz. (To change the settings, use **Pr.4**, **Pr.5**, and **Pr.6**, respectively.)
- In the initial setting, if two or more speed switches (signals) are simultaneously turned ON, priority is given to the switch (signal) for the lower speed. For example, when both RH and RM signals turn ON, the RM signal (**Pr.5**) has the higher priority.
- Up to 15-speed switching operation can be performed.

### Parameters referred to

Pr.4 to Pr.6 (multi-speed setting)  page 411

Pr.7 Acceleration time, Pr.8 Deceleration time  page 367

## 4.6.3 Setting the frequency using an analog signal (voltage input)

### Point

- Turn ON the STF/STR signal to give a start command.
- Use the frequency setting potentiometer to give a frequency command (by connecting it across terminals 2 and 5 (voltage input)).

[Connection diagram]

(The inverter supplies 5 V power to the frequency setting potentiometer via terminal 10.)

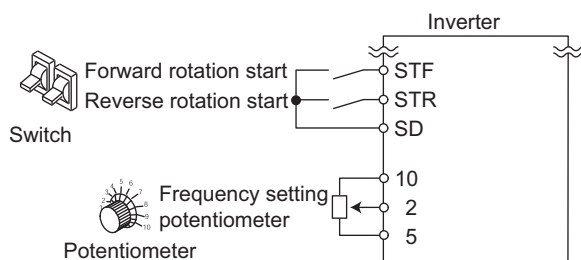

The following shows the procedure to operate at 60 Hz.

### Operating procedure

- 1.** Turning ON the power of the inverter  
The operation panel is in the monitor mode.
- 2.** Start  
Turn ON the start switch (STF/STR signal). [FWD] or [REV] indicator blinks as no frequency command is given.
- 3.** Acceleration → constant speed  
Turn the frequency setting potentiometer clockwise slowly to full. The frequency value on the monitor increases according to the setting of **Pr.7 Acceleration time**, and "60.00" (60.00 Hz) appears on the monitor. [FWD] indicator is ON during the forward rotation, and [REV] indicator is ON during the reverse rotation.
- 4.** Deceleration  
Turn the frequency setting potentiometer counterclockwise slowly to full. The frequency value on the monitor decreases according to the setting of **Pr.8 Deceleration time**, the monitor displays "00.00" (0.00 Hz), and the motor stops rotating. [FWD] or [REV] indicator blinks.
- 5.** Stop  
Turn OFF the start switch (STF/STR signal). [FWD] or [REV] indicator turns OFF.

**NOTE**

- When both the forward rotation start switch (STF signal) and the reverse rotation start switch (STR signal) are turned ON, the motor cannot be started. If both are turned ON while the inverter is running, the inverter decelerates to a stop.
- **Pr.178 STF terminal function selection** must be set to "60" (or **Pr.179 STR terminal function selection** must be set to "61") (initial value).
- When terminal 10 is used, the maximum output frequency may fluctuate in a range of  $\pm 6$  Hz due to fluctuations in the output voltage ( $5\text{ V} \pm 0.5\text{ VDC}$ ). Use **Pr. 125** or **Pr. C4** to adjust the output frequency at the maximum analog input as required. (Refer to [page 505](#).)
- When terminal 10E is used, the maximum output frequency may fluctuate (in a range of  $\pm 2$  to 3 Hz) due to fluctuations in the output voltage ( $10 \pm 0.4\text{ VDC}$ ). Use **Pr. 125** or **Pr. C4** to adjust the output frequency at the maximum analog input as required. (Refer to [page 505](#).)

**Parameters referred to**

**Pr.7 Acceleration time, Pr.8 Deceleration time**  [page 367](#)

**Pr.178 STF terminal function selection, Pr.179 STR terminal function selection**  [page 521](#)

## 4.6.4 Changing the frequency (60 Hz, initial value) at the maximum voltage input (5 V, initial value)

### Point

- Change the maximum frequency.

The following shows the procedure to change the frequency at 5 V from 60 Hz (initial value) to 50 Hz using a frequency setting potentiometer for 0 to 5 VDC input. Set 50 Hz in **Pr.125** so that the inverter outputs 50 Hz at 5 V input.

### Operating procedure

#### 1. Selecting the parameter

Turn  until "P. 125" (**Pr.125**) appears.

Press  to read the present set value. (60.00 Hz)

#### 2. Changing the maximum frequency

Turn  to change the set value to "50.00". (50.00 Hz)

Press  to confirm the selection. "50.00" and "P. 125" are displayed alternately.

#### 3. Selecting the mode and the monitor item

Press  three times to select the monitor mode, and change the monitor item to the frequency.

#### 4. Start

Turn ON the start switch (STF/STR signal), and turn the frequency setting potentiometer clockwise slowly to full. (Refer to steps 2 and 3 in 4.6.3.)

The motor is operated at 50 Hz.

### NOTE

- To change the frequency at the input of 0 V (minimum voltage), use **the calibration parameter C2**.

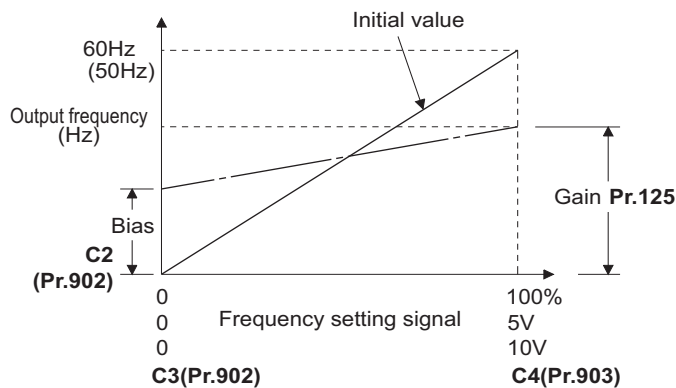

- Other adjustment methods for the frequency setting voltage gain are the following: adjustment by applying a voltage directly across terminals 2 and 5, and adjustment using a specified point without applying a voltage across terminals 2 and 5. (Refer to [page 505](#).)

### Parameters referred to

- Pr.125 Terminal 2 frequency setting gain frequency [page 505](#)
- C2(Pr.902) Terminal 2 frequency setting bias frequency [page 505](#)
- C4(Pr.903) Terminal 2 frequency setting gain [page 505](#)

## 4.6.5 Setting the frequency using an analog signal (current input)

### Point

- Turn ON the STF/STR signal to give a start command.
- Turn ON the AU signal.
- Set **Pr.79 Operation mode selection** = "2" (External operation mode).

[Connection diagram]

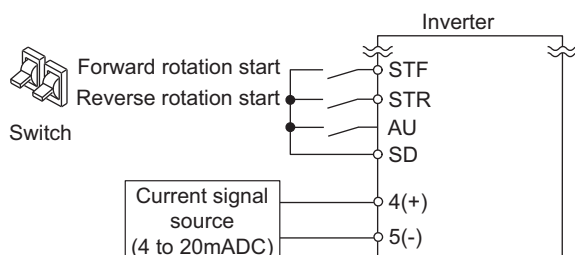

The following shows the procedure to operate at 60 Hz.

### Operating procedure

- 1.** Turning ON the power of the inverter  
The operation panel is in the monitor mode.
- 2.** Selecting the input via terminal 4  
Turn ON the Terminal 4 input selection (AU) signal. Input via terminal 4 to the inverter is enabled.
- 3.** Start  
Turn ON the start switch (STF/STR signal). [FWD] or [REV] indicator blinks as no frequency command is given.
- 4.** Acceleration → constant speed  
Input a current of 20 mA to the inverter from the regulator. The frequency value on the monitor increases according to the setting of **Pr.7 Acceleration time**, and "60.00" (60.00 Hz) appears on the monitor. [FWD] indicator is ON during the forward rotation, and [REV] indicator is ON during the reverse rotation.
- 5.** Deceleration  
Input a current of 4 mA or less. The frequency value on the monitor decreases according to the setting of **Pr.8 Deceleration time**, the monitor displays "0.00" (0.00 Hz), and the motor stops rotating. [FWD] or [REV] indicator blinks.
- 6.** Stop  
Turn OFF the start switch (STF/STR signal). [FWD] or [REV] indicator turns OFF.

### NOTE

- When both the forward rotation start switch (STF signal) and the reverse rotation start switch (STR signal) are turned ON, the motor cannot be started. If both are turned ON while the inverter is running, the inverter decelerates to a stop.
- **Pr.184 AU terminal function selection** must be set to "4 (initial value)" (AU signal).

### Parameters referred to

Pr.7 Acceleration time, Pr.8 Deceleration time [page 367](#)  
Pr.184 AU terminal function selection [page 521](#)

## 4.6.6 Changing the frequency (60 Hz, initial value) at the maximum current input (at 20 mA, initial value)

### Point

- Change the maximum frequency.

The following shows the procedure to change the frequency at 20 mA from 60 Hz (initial value) to 50 Hz using a frequency setting potentiometer for 4 to 20 mA input. Set 50 Hz in **Pr.126** so that the inverter outputs 50 Hz at 20 mA input.

### Operating procedure

#### 1. Selecting the parameter

Turn  until "P. 126" (**Pr.126**) appears.

Press  to read the present set value (60.00 Hz).

#### 2. Changing the maximum frequency

Turn  to change the set value to "50.00" (50.00 Hz).

Press  to confirm the selection. "50.00" and "P. 126" are displayed alternately.

#### 3. Selecting the mode and the monitor item

Press  three times to select the monitor mode and to monitor a frequency.

#### 4. Start

Turn ON the start switch (STF or STR) to apply a 20 mA current (refer to steps 3 and 4 in 4.6.5).

Operate at 50 Hz.

### NOTE

- To change the frequency at the input of 4 mA (minimum current), use **the calibration parameter C5**.

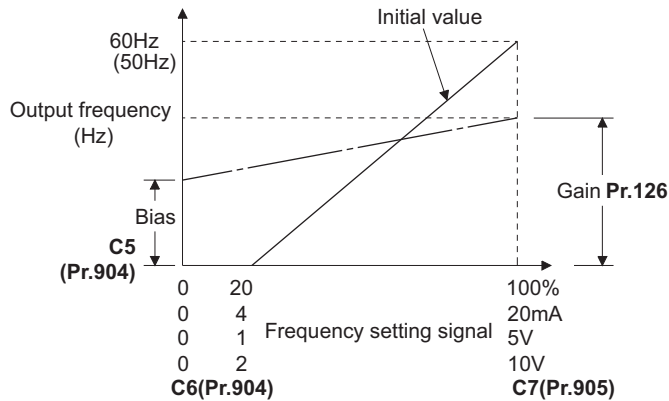

- Other adjustment methods for the frequency setting current gain are the following: adjustment by applying a current through terminals 4 and 5, and adjustment using a specified point without applying a current through terminals 4 and 5. (Refer to [page 505](#).)

### Parameters referred to

Pr.126 Terminal 4 frequency setting gain frequency [page 505](#)

C5(Pr.904) Terminal 4 frequency setting bias frequency [page 505](#)

C7(Pr.905) Terminal 4 frequency setting gain [page 505](#)

## 4.7 Basic operation procedure (JOG operation)

### 4.7.1 Giving a start command by using external signals for JOG operation

#### Point

- JOG operation is performed while the JOG signal is ON.
- Use **Pr.15 Jog frequency** to set a frequency, and set **Pr.16 Jog acceleration/deceleration time** to set the acceleration/deceleration time for JOG operation.
- Set **Pr.79 Operation mode selection** = "2" (External operation mode).

[Connection diagram]

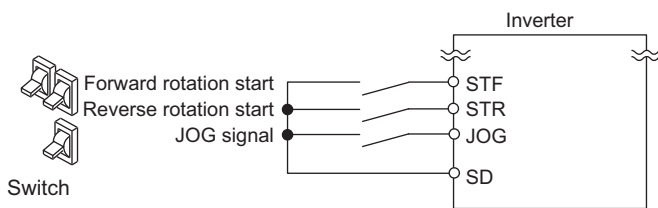

The following shows the procedure to operate at 5 Hz.

#### Operating procedure

- 1.** Turning ON the power of the inverter  
The operation panel is in the monitor mode.
- 2.** Turning ON the JOG signal  
Turn ON the JOG switch (JOG signal). The inverter is set ready for the JOG operation.
- 3.** Start → acceleration → constant speed  
Turn ON the start switch (STF/STR signal). The frequency increases according to the setting of **Pr.16 Jog acceleration/deceleration time**, and "5.00" (5.00 Hz) appears on the LCD display. [FWD] indicator is ON during the forward rotation, and [REV] indicator is ON during the reverse rotation.
- 4.** Deceleration → stop  
Turn OFF the start switch (STF/STR signal). The frequency decreases according to the setting of **Pr.16 Jog acceleration/deceleration time**. "0.00" (0.00 Hz) appears on the LCD display, and the motor stops rotating. [FWD] or [REV] indicator turns OFF. Turn OFF the JOG switch (JOG signal).

#### NOTE

- To change the frequency, change the setting of **Pr.15 Jog frequency** (initial value: 5 Hz).
- To change the acceleration/deceleration time, change the setting of **Pr.16 Jog acceleration/deceleration time** (initial value: 0.5 second).

#### Parameters referred to

**Pr.15 Jog frequency**, **Pr.16 Jog acceleration/deceleration time** page 410  
**Pr.79 Operation mode selection** page 389

## 4.7.2 Giving a start command from the operation panel for JOG operation

### Point

- JOG operation is performed while  or  on the operation panel is pressed.



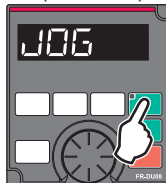

Operation panel  
(FR-DU08)



4

The following shows the procedure to operate at 5 Hz.

### Operating procedure

- 1.** Turning ON the power of the inverter  
The operation panel is in the monitor mode.
- 2.** Changing the operation mode  
Press  twice to choose the PUJOG operation mode. The display shows "JOG", and [PU] indicator is ON.
- 3.** Start → acceleration → constant speed  
Hold  or  down to keep the JOG operation. The frequency increases according to the setting of **Pr.16 Jog acceleration/deceleration time**, and "5.00" (5.00 Hz) appears on the LCD display.
- 4.** Deceleration → stop  
Release  or . The frequency decreases according to the setting of **Pr.16 Jog acceleration/deceleration time**. "0.00" (0.00 Hz) appears on the LCD display, and the motor stops rotating.

### NOTE

- To change the frequency, change the setting of **Pr.15 Jog frequency** (initial value: 5 Hz).
- To change the acceleration/deceleration time, change the setting of **Pr.16 Jog acceleration/deceleration time** (initial value: 0.5 second).

### Parameters referred to

Pr.15 Jog frequency, Pr.16 Jog acceleration/deceleration time  page 410



# MEMO

# CHAPTER 5 PARAMETERS





5.1	Parameter list.....	166
5.2	Control method .....	216
5.3	Speed control under Real sensorless vector control, vector control, PM sensorless vector control .....	235
5.4	Torque control under Real sensorless vector control and Vector control .....	272
5.5	Position control under vector control and PM sensorless vector control .....	298
5.6	Adjustment during Real sensorless vector control, Vector control, PM sensorless vector control .....	332
5.7	(E) Environment setting parameters .....	334
5.8	(F) Setting of acceleration/deceleration time and acceleration/deceleration pattern .....	367
5.9	(D) Operation command and frequency command.....	389
5.10	(H) Protective function parameter.....	415
5.11	(M) Item and output signal for monitoring .....	444
5.12	(T) Multi-function input terminal parameters .....	496
5.13	(C) Motor constant parameters .....	528
5.14	(A) Application parameters .....	562
5.15	(N) Communication operation parameters.....	659
5.16	(G) Control parameters.....	705
5.17	Parameter clear / All parameter clear .....	743
5.18	Copying and verifying parameters on the operation panel .....	744
5.19	Copying and verifying parameters using a USB memory .....	747
5.20	Checking parameters changed from their initial values (initial value change list).....	751
5.21	CC-Link IE Field Network (FR-A800-GF) .....	752

# 5 PARAMETERS

This chapter explains the function setting for use of this product.

Always read the instructions before use.

The following marks are used to indicate the controls. (Parameters without any mark are valid for all the controls.)

Mark	Control method	Applied motor
	V/F control	Three-phase induction motor
	Advanced magnetic flux vector control	
	Real sensorless vector control	
	Vector control	Three-phase induction motor, PM motor
	PM sensorless vector control	PM motor

The setting range and the initial value of parameters differ depending on the structure or functions of the inverter. The following common designations are used for each type of the inverter models.

Inverter model	Common designation
FR-A8[]0	Standard model
FR-A8[]2	Separated converter type
FR-A8[]6	IP55 compatible model

## 5.1 Parameter list

### 5.1.1 Parameter list (by parameter number)

For simple variable-speed operation of the inverter, the initial values of the parameters may be used as they are. Set the necessary parameters to meet the load and operational specifications. Parameter's setting, change and check can be made on the operation panel (FR-DU08).

#### NOTE

-  indicates simple mode parameters. Use **Pr.160 User group read selection** to indicate the simple mode parameters only (initial setting is to indicate the extended mode parameters).
- The changing of the parameter settings may be restricted in some operating statuses. Use **Pr.77 Parameter write selection** to change the setting of the restriction.
- Refer to [page 864](#) for instruction codes for communication and availability of Parameter clear, all clear, and Parameter copy.

Function	Pr.	Pr. group	Name	Setting range	Minimum setting increments	Initial value		Refer to page	Customer setting
						FM	CA		
Basic function	0	G000	Torque boost <i>Simple</i>	0 to 30%	0.1%	6% <sup>*1</sup>	706		
						4% <sup>*1</sup>			
						3% <sup>*1</sup>			
						2% <sup>*1</sup>			
						1% <sup>*1</sup>			
	1	H400	Maximum frequency <i>Simple</i>	0 to 120 Hz	0.01 Hz	120 Hz <sup>*2</sup>	428		
						60 Hz <sup>*3</sup>			
	2	H401	Minimum frequency <i>Simple</i>	0 to 120 Hz	0.01 Hz	0 Hz	428		
	3	G001	Base frequency <i>Simple</i>	0 to 590 Hz	0.01 Hz	60 Hz	50 Hz	707	
	4	D301	Multi-speed setting (high speed) <i>Simple</i>	0 to 590 Hz	0.01 Hz	60 Hz	50 Hz	411	
5	D302	Multi-speed setting (middle speed) <i>Simple</i>	0 to 590 Hz	0.01 Hz	30 Hz		411		
6	D303	Multi-speed setting (low speed) <i>Simple</i>	0 to 590 Hz	0.01 Hz	10 Hz		411		
7	F010	Acceleration time <i>Simple</i>	0 to 3600 s	0.1 s	5s <sup>*4</sup>	367			
					15s <sup>*5</sup>				
8	F011	Deceleration time <i>Simple</i>	0 to 3600 s	0.1 s	5s <sup>*4</sup>	367			
					15s <sup>*5</sup>				
9	H000 C103	Electronic thermal O/L relay <i>Simple</i> Rated motor current <i>Simple</i>	0 to 500 A <sup>*2</sup> 0 to 3600 A <sup>*3</sup>	0.01 A <sup>*2</sup> 0.1 A <sup>*3</sup>	Inverter rated current		415, 532, 551		
DC injection brake	10	G100	DC injection brake operation frequency	0 to 120 Hz, 9999	0.01 Hz	3 Hz	715		
	11	G101	DC injection brake operation time	0 to 10 s, 8888	0.1 s	0.5 s	715		
	12	G110	DC injection brake operation voltage	0 to 30%	0.1%	4% <sup>*6</sup>	715		
					2% <sup>*6</sup>				
					1% <sup>*6</sup>				
—	13	F102	Starting frequency	0 to 60 Hz	0.01 Hz	0.5 Hz	381, 382		
—	14	G003	Load pattern selection	0 to 5, 12 to 15	1	0	708		
JOG operation	15	D200	Jog frequency	0 to 590 Hz	0.01 Hz	5 Hz	410		
	16	F002	Jog acceleration/ deceleration time	0 to 3600 s	0.1 s	0.5 s	410		
—	17	T720	MRS input selection	0, 2, 4	1	0	524		
—	18	H402	High speed maximum frequency	0 to 590 Hz	0.01 Hz	120 Hz <sup>*2</sup>	428		
						60 Hz <sup>*3</sup>			
—	19	G002	Base frequency voltage	0 to 1000 V, 8888, 9999	0.1 V	9999	8888	707	
Acceleration/deceleration time	20	F000	Acceleration/deceleration reference frequency	1 to 590 Hz	0.01 Hz	60 Hz	50 Hz	367	
	21	F001	Acceleration/deceleration time increments	0, 1	1	0		367	

Function	Pr.	Pr. group	Name	Setting range	Minimum setting increments	Initial value		Refer to page	Customer setting
						FM	CA		
Stall prevention	22	H500	Stall prevention operation level (Torque limit level)	0 to 400%	0.1%	150%		245, 431	
	23	H610	Stall prevention operation level compensation factor at double speed	0 to 200%, 9999	0.1%	9999		431	
Multi-speed setting	24 to 27	D304 to D307	Multi-speed setting (speed 4 to speed 7)	0 to 590 Hz, 9999	0.01 Hz	9999		411	
—	28	D300	Multi-speed input compensation selection	0, 1	1	0		411	
—	29	F100	Acceleration/deceleration pattern selection	0 to 6	1	0		372	
—	30	E300	Regenerative function selection	0 to 2, 10, 11, 20, 21, 100 to 102, 110, 111, 120, 121 <sup>*11</sup>	1	0		724	
				2, 10, 11, 102, 110, 111 <sup>*12</sup>	1	10			
				0, 2, 10, 20, 100, 102, 110, 120 <sup>*13</sup>	1	0			
Frequency jump	31	H420	Frequency jump 1A	0 to 590 Hz, 9999	0.01 Hz	9999		429	
	32	H421	Frequency jump 1B	0 to 590 Hz, 9999	0.01 Hz	9999		429	
	33	H422	Frequency jump 2A	0 to 590 Hz, 9999	0.01 Hz	9999		429	
	34	H423	Frequency jump 2B	0 to 590 Hz, 9999	0.01 Hz	9999		429	
	35	H424	Frequency jump 3A	0 to 590 Hz, 9999	0.01 Hz	9999		429	
	36	H425	Frequency jump 3B	0 to 590 Hz, 9999	0.01 Hz	9999		429	
—	37	M000	Speed display	0, 1 to 9998	1	0		444	
Frequency detection	41	M441	Up-to-frequency sensitivity	0 to 100%	0.1%	10%		484	
	42	M442	Output frequency detection	0 to 590 Hz	0.01 Hz	6 Hz		484	
	43	M443	Output frequency detection for reverse rotation	0 to 590 Hz, 9999	0.01 Hz	9999		484	
Second function	44	F020	Second acceleration/ deceleration time	0 to 3600 s	0.1 s	5 s		367, 622	
	45	F021	Second deceleration time	0 to 3600 s, 9999	0.1 s	9999		367, 622	
	46	G010	Second torque boost	0 to 30%, 9999	0.1%	9999		706	
	47	G011	Second V/F (base frequency)	0 to 590 Hz, 9999	0.01 Hz	9999		707	
	48	H600	Second stall prevention operation level	0 to 400%	0.1%	150%		431	
	49	H601	Second stall prevention operation frequency	0 to 590 Hz, 9999	0.01 Hz	0 Hz		431	
	50	M444	Second output frequency detection	0 to 590 Hz	0.01 Hz	30 Hz		484	
	51	H010 C203	Second electronic thermal O/L relay Rated second motor current	0 to 500 A, 9999 <sup>*2</sup> 0 to 3600 A, 9999 <sup>*3</sup>	0.01 A <sup>*2</sup> 0.1 A <sup>*3</sup>	9999		415, 532, 551	

Function	Pr.	Pr. group	Name	Setting range	Minimum setting increments	Initial value		Refer to page	Customer setting
						FM	CA		
Monitoring function	52	M100	Operation panel main monitor selection	0, 5 to 14, 17 to 20, 22 to 36, 38 to 46, 50 to 57, 61, 62, 64, 67, 71 to 75, 87 to 98, 100	1	0		446	
	54	M300	FM/CA terminal function selection	1 to 3, 5 to 14, 17, 18, 21, 24, 32 to 34, 36, 46, 50, 52, 53, 61, 62, 67, 70, 87 to 90, 92, 93, 95, 97, 98	1	1		457	
	55	M040	Frequency monitoring reference	0 to 590 Hz	0.01 Hz	60 Hz	50 Hz	457	
	56	M041	Current monitoring reference	0 to 500 A <sup>*2</sup> 0 to 3600 A <sup>*3</sup>	0.01 A <sup>*2</sup> 0.1 A <sup>*3</sup>	Inverter rated current		457	
Automatic restart	57	A702	Restart coasting time	0, 0.1 to 30 s, 9999	0.1 s	9999		628, 635	
	58	A703	Restart cushion time	0 to 60 s	0.1 s	1 s		628	
—	59	F101	Remote function selection	0 to 3, 11 to 13	1	0		377	
—	60	G030	Energy saving control selection	0, 4, 9	1	0		712	
Automatic acceleration/deceleration	61	F510	Reference current	0 to 500 A, 9999 <sup>*2</sup>	0.01 A <sup>*2</sup>	9999		384, 387	
				0 to 3600 A, 9999 <sup>*3</sup>	0.1 A <sup>*3</sup>				
	62	F511	Reference value at acceleration	0 to 400%, 9999	0.1%	9999		384	
	63	F512	Reference value at deceleration	0 to 400%, 9999	0.1%	9999		384	
64	F520	Starting frequency for elevator mode	0 to 10 Hz, 9999	0.01 Hz	9999		387		
—	65	H300	Retry selection	0 to 5	1	0		426	
—	66	H611	Stall prevention operation reduction starting frequency	0 to 590 Hz	0.01 Hz	60 Hz	50 Hz	431	
Retry	67	H301	Number of retries at fault occurrence	0 to 10, 101 to 110	1	0		426	
	68	H302	Retry waiting time	0.1 to 600 s	0.1 s	1 s		426	
	69	H303	Retry count display erase	0	1	0		426	
—	70 <sup>*14</sup>	G107	Special regenerative brake duty	0 to 100%	0.1%	0%		724	
—	71	C100	Applied motor	0 to 6, 13 to 16, 20, 23, 24, 30, 33, 34, 40, 43, 44, 50, 53, 54, 70, 73, 74, 330, 333, 334, 8090, 8093, 8094, 9090, 9093, 9094	1	0		528, 532, 551	
—	72	E600	PWM frequency selection	0 to 15 <sup>*2</sup> 0 to 6, 25 <sup>*3</sup>	1	2		356	
—	73	T000	Analog input selection	0 to 7, 10 to 17	1	1		496, 501	
—	74	T002	Input filter time constant	0 to 8	1	1		503	

Function	Pr.	Pr. group	Name	Setting range	Minimum setting increments	Initial value		Refer to page	Customer setting		
						FM	CA				
—	75	—	Reset selection/ disconnected PU detection/ PU stop selection	0 to 3, 14 to 17, 1000 to 1003, 1014 to 1017	1	14		336			
				0 to 3, 14 to 17, 100 to 103, 114 to 117, 1000 to 1003, 1014 to 1017, 1100 to 1103, 1114 to 1117							
			E100	Reset selection						0 to 3	0
			E101	Disconnected PU detection						0, 1	1
			E102	PU stop selection						0 <sup>*2</sup>	0
				0, 1 <sup>*3</sup>	1						
—	76	M510	Fault code output selection	0 to 2	1	0		492			
—	77	E400	Parameter write selection	0 to 2	1	0		345			
—	78	D020	Reverse rotation prevention selection	0 to 2	1	0		406			
—	79	D000	Operation mode selection <i>Simple</i>	0 to 4, 6, 7	1	0		389, 398			
Motor constant	80	C101	Motor capacity	0.4 to 55 kW, 9999 <sup>*2</sup>	0.01 kW <sup>*2</sup>	9999		221, 532, 551			
				0 to 3600 kW, 9999 <sup>*3</sup>	0.1 kW <sup>*3</sup>						
	81	C102	Number of motor poles	2, 4, 6, 8, 10, 12, 9999	1	9999		221, 532, 551			
	82	C125	Motor excitation current	0 to 500 A, 9999 <sup>*2</sup>	0.01 A <sup>*2</sup>	9999		532			
				0 to 3600 A, 9999 <sup>*3</sup>	0.1 A <sup>*3</sup>						
	83	C104	Rated motor voltage	0 to 1000 V	0.1 V		200 V <sup>*7</sup> 400 V <sup>*8</sup>	221, 532, 551			
	84	C105	Rated motor frequency	10 to 400 Hz, 9999	0.01 Hz	9999		221, 532, 551			
	85	G201	Excitation current break point	0 to 400 Hz, 9999	0.01 Hz	9999		711			
	86	G202	Excitation current low-speed scaling factor	0 to 300%, 9999	0.1%	9999		711			
	89	G932	Speed control gain (Advanced magnetic flux vector)	0 to 200%, 9999	0.1%	9999		228			
	90	C120	Motor constant (R1)	0 to 50 Ω, 9999 <sup>*2</sup>	0.001Ω <sup>*2</sup>	9999		532, 551, 638			
				0 to 400 mΩ, 9999 <sup>*3</sup>	0.01mΩ <sup>*3</sup>						
	91	C121	Motor constant (R2)	0 to 50 Ω, 9999 <sup>*2</sup>	0.001Ω <sup>*2</sup>	9999		532			
				0 to 400 mΩ, 9999 <sup>*3</sup>	0.01mΩ <sup>*3</sup>						
	92	C122	Motor constant (L1)/d-axis inductance (Ld)	0 to 6000 mH, 9999 <sup>*2</sup>	0.1mH <sup>*2</sup>	9999		532, 551			
				0 to 400 mH, 9999 <sup>*3</sup>	0.01mH <sup>*3</sup>						
	93	C123	Motor constant (L2)/q-axis inductance (Lq)	0 to 6000 mH, 9999 <sup>*2</sup>	0.1mH <sup>*2</sup>	9999		532, 551			
				0 to 400 mH, 9999 <sup>*3</sup>	0.01mH <sup>*3</sup>						
94	C124	Motor constant (X)	0 to 100%, 9999	0.1% <sup>*2</sup>	9999		532				
				0.01% <sup>*3</sup>							
95	C111	Online auto tuning selection	0 to 2	1	0		558				
96	C110	Auto tuning setting/status	0, 1, 11, 101	1	0		532, 551, 638				

Function	Pr.	Pr. group	Name	Setting range	Minimum setting increments	Initial value		Refer to page	Customer setting
						FM	CA		
Adjustable 5 points V/F	100	G040	V/F1 (first frequency)	0 to 590 Hz, 9999	0.01 Hz	9999		713	
	101	G041	V/F1 (first frequency voltage)	0 to 1000 V	0.1 V	0 V		713	
	102	G042	V/F2 (second frequency)	0 to 590 Hz, 9999	0.01 Hz	9999		713	
	103	G043	V/F2 (second frequency voltage)	0 to 1000 V	0.1 V	0 V		713	
	104	G044	V/F3 (third frequency)	0 to 590 Hz, 9999	0.01 Hz	9999		713	
	105	G045	V/F3 (third frequency voltage)	0 to 1000 V	0.1 V	0 V		713	
	106	G046	V/F4 (fourth frequency)	0 to 590 Hz, 9999	0.01 Hz	9999		713	
	107	G047	V/F4 (fourth frequency voltage)	0 to 1000 V	0.1 V	0 V		713	
	108	G048	V/F5 (fifth frequency)	0 to 590 Hz, 9999	0.01 Hz	9999		713	
	109	G049	V/F5 (fifth frequency voltage)	0 to 1000 V	0.1 V	0 V		713	
Third function	110	F030	Third acceleration/ deceleration time	0 to 3600 s, 9999	0.1 s	9999		367	
	111	F031	Third deceleration time	0 to 3600 s, 9999	0.1 s	9999		367	
	112	G020	Third torque boost	0 to 30%, 9999	0.1%	9999		706	
	113	G021	Third V/F (base frequency)	0 to 590 Hz, 9999	0.01 Hz	9999		707	
	114	H602	Third stall prevention operation level	0 to 400%	0.1%	150%		431	
	115	H603	Third stall prevention operation frequency	0 to 590 Hz	0.01 Hz	0 Hz		431	
	116	M445	Third output frequency detection	0 to 590 Hz	0.01 Hz	60 Hz	50 Hz	484	
PU connector communication	117	N020	PU communication station number	0 to 31	1	0		670	
	118	N021	PU communication speed	48, 96, 192, 384, 576, 768, 1152	1	192		670	
	119	—	PU communication stop bit length / data length	0, 1, 10, 11	1	1		670	
		N022	PU communication data length	0, 1		0			
		N023	PU communication stop bit length	0, 1		1			
	120	N024	PU communication parity check	0 to 2	1	2		670	
	121	N025	PU communication retry count	0 to 10, 9999	1	1		670	
	122	N026	PU communication check time interval	0, 0.1 to 999.8 s, 9999	0.1 s	9999		670	
	123	N027	PU communication waiting time setting	0 to 150 ms, 9999	1 ms	9999		670	
	124	N028	PU communication CR/LF selection	0 to 2	1	1		670	
I	125	T022	Terminal 2 frequency setting gain frequency <i>Simple</i>	0 to 590 Hz	0.01 Hz	60 Hz	50 Hz	505	
I	126	T042	Terminal 4 frequency setting gain frequency <i>Simple</i>	0 to 590 Hz	0.01 Hz	60 Hz	50 Hz	505	



Function	Pr.	Pr. group	Name	Setting range	Minimum setting increments	Initial value		Refer to page	Customer setting
						FM	CA		
PID operation	127	A612	PID control automatic switchover frequency	0 to 590 Hz, 9999	0.01 Hz	9999		601	
	128	A610	PID action selection	0, 10, 11, 20, 21, 40 to 43, 50, 51, 60, 61, 70, 71, 80, 81, 90, 91, 100, 101, 1000, 1001, 1010, 1011, 2000, 2001, 2010, 2011	1	0		601, 622	
	129	A613	PID proportional band	0.1 to 1000%, 9999	0.1%	100%		601, 622	
	130	A614	PID integral time	0.1 to 3600 s, 9999	0.1 s	1 s		601, 622	
	131	A601	PID upper limit	0 to 100%, 9999	0.1%	9999		601, 622	
	132	A602	PID lower limit	0 to 100%, 9999	0.1%	9999		601, 622	
	133	A611	PID action set point	0 to 100%, 9999	0.01%	9999		601, 622	
	134	A615	PID differential time	0.01 to 10 s, 9999	0.01 s	9999		601, 622	
Bypass	135	A000	Electronic bypass sequence selection	0, 1	1	0		563	
	136	A001	MC switchover interlock time	0 to 100 s	0.1 s	1 s		563	
	137	A002	Start waiting time	0 to 100 s	0.1 s	0.5 s		563	
	138	A003	Bypass selection at a fault	0, 1	1	0		563	
	139	A004	Automatic switchover frequency from inverter to bypass operation	0 to 60 Hz, 9999	0.01 Hz	9999		563	
Backlash measure	140	F200	Backlash acceleration stopping frequency	0 to 590 Hz	0.01 Hz	1 Hz		372	
	141	F201	Backlash acceleration stopping time	0 to 360 s	0.1 s	0.5 s		372	
	142	F202	Backlash deceleration stopping frequency	0 to 590 Hz	0.01 Hz	1 Hz		372	
	143	F203	Backlash deceleration stopping time	0 to 360 s	0.1 s	0.5 s		372	
—	144	M002	Speed setting switchover	0, 2, 4, 6, 8, 10, 12, 102, 104, 106, 108, 110, 112	1	4		444	
PU	145	E103	PU display language selection	0 to 7	1	—		339	
—	147	F022	Acceleration/deceleration time switching frequency	0 to 590 Hz, 9999	0.01 Hz	9999		367	
Current detection	148	H620	Stall prevention level at 0 V input	0 to 400%	0.1%	150%		431	
	149	H621	Stall prevention level at 10 V input	0 to 400%	0.1%	200%		431	
	150	M460	Output current detection level	0 to 400%	0.1%	150%		487	
	151	M461	Output current detection signal delay time	0 to 10 s	0.1 s	0 s		487	
	152	M462	Zero current detection level	0 to 400%	0.1%	5%		487	
	153	M463	Zero current detection time	0 to 10 s	0.01 s	0.5 s		487	
—	154	H631	Voltage reduction selection during stall prevention operation	0, 1, 10, 11	1	1		431	
—	155	T730	RT signal function validity condition selection	0, 10	1	0		525	
—	156	H501	Stall prevention operation selection	0 to 31, 100, 101	1	0		431	
—	157	M430	OL signal output timer	0 to 25 s, 9999	0.1 s	0 s		245, 431	

Function	Pr.	Pr. group	Name	Setting range	Minimum setting increments	Initial value		Refer to page	Customer setting	
						FM	CA			
—	158	M301	AM terminal function selection	1 to 3, 5 to 14, 17, 18, 21, 24, 32 to 34, 36, 46, 50, 52 to 54, 61, 62, 67, 70, 87 to 90, 91 to 98	1	1		457		
—	159	A005	Automatic switchover frequency range from bypass to inverter operation	0 to 10 Hz, 9999	0.01 Hz	9999		563		
—	160	E440	User group read selection <i>Simple</i>	0, 1, 9999	1	0		354		
—	161	E200	Frequency setting/key lock operation selection	0, 1, 10, 11	1	0		341		
Automatic restart	162	A700	Automatic restart after instantaneous power failure selection	0 to 3, 10 to 13, 1000 to 1003, 1010 to 1013	1	0		628, 635, 638		
	163	A704	First cushion time for restart	0 to 20 s	0.1 s	0 s		628		
	164	A705	First cushion voltage for restart	0 to 100%	0.1%	0%		628		
	165	A710	Stall prevention operation level for restart	0 to 400%	0.1%	150%		628		
Current detection	166	M433	Output current detection signal retention time	0 to 10 s, 9999	0.1 s	0.1 s		487		
	167	M464	Output current detection operation selection	0, 1, 10, 11	1	0		487		
—	168	E000 E080	Parameter for manufacturer setting. Do not set.							
—	169	E001 E081								
Cumulative monitor	170	M020		Watt-hour meter clear	0, 10, 9999	1	9999		446	
	171	M030		Operation hour meter clear	0, 9999	1	9999		446	
User group	172	E441	User group registered display/batch clear	9999, (0 to 16)	1	0		354		
	173	E442	User group registration	0 to 1999, 9999	1	9999		354		
	174	E443	User group clear	0 to 1999, 9999	1	9999		354		

Function	Pr.	Pr. group	Name	Setting range	Minimum setting increments	Initial value		Refer to page	Customer setting
						FM	CA		
Input terminal function assignment	178	T700	STF terminal function selection	0 to 20, 22 to 28, 32, 37, 42 to 48, 50 to 53, 57 to 60, 62, 64 to 74, 76 to 80, 85, 87 to 89, 92 to 96, 128, 129, 9999	1	60		521	
	179	T701	STR terminal function selection	0 to 20, 22 to 28, 32, 37, 42 to 48, 50 to 53, 57 to 59, 61, 62, 64 to 74, 76 to 80, 85, 87 to 89, 92 to 96, 128, 129, 9999	1	61		521	
	180	T702	RL terminal function selection	0 to 20, 22 to 28, 32, 37, 42 to 48, 50 to 53, 57 to 59, 62, 64 to 74, 76 to 80, 85, 87 to 89, 92 to 96, 128, 129, 9999	1	0		521	
	181	T703	RM terminal function selection		1	1		521	
	182	T704	RH terminal function selection		1	2		521	
	183	T705	RT terminal function selection		1	3		521	
	184	T706	AU terminal function selection		1	4		521	
	185	T707	JOG terminal function selection		1	5		521	
	186	T708	CS terminal function selection		1	6		521	
	187	T709	MRS terminal function selection		1	24 <sup>*11*13</sup> 10 <sup>*12</sup>		521	
	188	T710	STOP terminal function selection		1	25		521	
189	T711	RES terminal function selection	1		62		521		
Output terminal function assignment	190	M400	RUN terminal function selection		0 to 8, 10 to 20, 22, 25 to 28, 30 to 36, 38 to 57, 60, 61, 63, 64, 67, 68, 70, 79, 80, 84, 85, 90 to 99, 100 to 108, 110 to 116, 120, 122, 125 to 128, 130 to 136, 138 to 157, 160, 161, 163, 164, 167, 168, 170, 179, 180, 184, 185, 190 to 199, 200 to 208, 211 to 213, 247, 300 to 308, 311 to 313, 347, 9999	1	0		473
	191	M401	SU terminal function selection	1	1		473		
	192	M402	IPF terminal function selection	1	2 <sup>*11*13</sup> 9999 <sup>*12</sup>		473		
	193	M403	OL terminal function selection	1	3		473		
	194	M404	FU terminal function selection	1	4		473		
	195	M405	ABC1 terminal function selection	0 to 8, 10 to 20, 22, 25 to 28, 30 to 36, 38 to 57, 60, 61, 63, 64, 67, 68, 70, 79, 80, 84, 85, 90, 91, 94 to 99, 100 to 108, 110 to 116, 120, 122, 125 to 128, 130 to 136, 138 to 157, 160, 161, 163, 164, 167, 168, 170, 179, 180, 184, 185, 190, 191, 194 to 199, 200 to 208, 211 to 213, 247, 300 to 308, 311 to 313, 347, 9999	1	99		473	
	196	M406	ABC2 terminal function selection	1	9999		473		

Function	Pr.	Pr. group	Name	Setting range	Minimum setting increments	Initial value		Refer to page	Customer setting
						FM	CA		
Multi-speed setting	232 to 239	D308 to D315	Multi-speed setting (speed 8 to speed 15)	0 to 590 Hz, 9999	0.01 Hz	9999		411	
—	240	E601	Soft-PWM operation selection	0, 1	1	1		356	
—	241	M043	Analog input display unit switchover	0, 1	1	0		505	
—	242	T021	Terminal 1 added compensation amount (terminal 2)	0 to 100%	0.1%	100%		501	
—	243	T041	Terminal 1 added compensation amount (terminal 4)	0 to 100%	0.1%	75%		501	
—	244	—	Cooling fan operation selection	0, 1, 101 to 105, 1000, 1001, 1101 to 1105	1	1		423	
		H100	Cooling fan operation selection	0, 1, 101 to 105	1	1			
		H106	Cooling fan operation selection during the test operation	0, 1	1	0			
Slip compensation	245	G203	Rated slip	0 to 50%, 9999	0.01%	9999		736	
	246	G204	Slip compensation time constant	0.01 to 10 s	0.01 s	0.5 s		736	
	247	G205	Constant output range slip compensation selection	0, 9999	1	9999		736	
—	248	A006	Self power management selection	0 to 2	1	0		569	
—	249	H101	Earth (ground) fault detection at start	0, 1	1	0		425	
—	250	G106	Stop selection	0 to 100 s, 1000 to 1100 s, 8888, 9999	0.1s	9999		722	
—	251	H200	Output phase loss protection selection	0, 1	1	1		426	
Frequency compensation	252	T050	Override bias	0 to 200%	0.1%	50%		501	
	253	T051	Override gain	0 to 200%	0.1%	150%		501	
—	254	A007	Main circuit power OFF waiting time	0 to 3600 s, 9999	1 s	600 s		569	
Life check	255	E700	Life alarm status display	(0 to 255)	1	0		359	
	256 <sup>*15</sup>	E701	Inrush current limit circuit life display	(0 to 100%)	1%	100%		359	
	257	E702	Control circuit capacitor life display	(0 to 100%)	1%	100%		359	
	258 <sup>*15</sup>	E703	Main circuit capacitor life display	(0 to 100%)	1%	100%		359	
	259 <sup>*15</sup>	E704	Main circuit capacitor life measuring	0, 1, 11	1	0		359	
—	260	E602	PWM frequency automatic switchover	0, 1	1	1		356	

Function	Pr.	Pr. group	Name	Setting range	Minimum setting increments	Initial value		Refer to page	Customer setting
						FM	CA		
Power failure stop	261	A730	Power failure stop selection	0 to 2, 11, 12, 21, 22	1	0		642	
	262	A731	Subtracted frequency at deceleration start	0 to 20 Hz	0.01 Hz	3 Hz		642	
	263	A732	Subtraction starting frequency	0 to 590 Hz, 9999	0.01 Hz	60 Hz	50 Hz	642	
	264	A733	Power-failure deceleration time 1	0 to 3600 s	0.1 s	5 s		642	
	265	A734	Power-failure deceleration time 2	0 to 3600 s, 9999	0.1 s	9999		642	
	266	A735	Power failure deceleration time switchover frequency	0 to 590 Hz	0.01 Hz	60 Hz	50 Hz	642	
—	267	T001	Terminal 4 input selection	0 to 2	1	0		496	
—	268	M022	Monitor decimal digits selection	0, 1, 9999	1	9999		446	
—	269	E023	Parameter for manufacturer setting. Do not set.						
—	270	A200	Stop-on contact/load torque high-speed frequency control selection	0 to 3, 11 to 13	1	0		577, 580	
Load torque high-speed frequency control	271	A201	High-speed setting maximum current	0 to 400%	0.1%	50%		580	
	272	A202	Middle-speed setting minimum current	0 to 400%	0.1%	100%		580	
	273	A203	Current averaging range	0 to 590 Hz, 9999	0.01 Hz	9999		580	
	274	A204	Current averaging filter time constant	1 to 4000	1	16		580	
Stop-on-contact control	275	A205	Stop-on contact excitation current low-speed scaling factor	0 to 300%, 9999	0.1%	9999		577	
	276	A206	PWM carrier frequency at stop-on contact	0 to 9, 9999 <sup>*2</sup> 0 to 4, 9999 <sup>*3</sup>	1	9999		577	
Brake sequence	278	A100	Brake opening frequency	0 to 30 Hz	0.01 Hz.	3 Hz		572	
	279	A101	Brake opening current	0 to 400%	0.1%	130%		572	
	280	A102	Brake opening current detection time	0 to 2 s	0.1 s	0.3 s		572	
	281	A103	Brake operation time at start	0 to 5 s	0.1 s	0.3 s		572	
	282	A104	Brake operation frequency	0 to 30 Hz	0.01 Hz.	6 Hz		572	
	283	A105	Brake operation time at stop	0 to 5 s	0.1 s	0.3 s		572	
	284	A106	Deceleration detection function selection	0, 1	1	0		572	
	285	A107 H416	Overspeed detection frequency Speed deviation excess detection frequency	0 to 30 Hz, 9999	0.01 Hz.	9999		269, 572, 736	
Droop control	286	G400	Droop gain	0 to 100%	0.1%	0%		738	
	287	G401	Droop filter time constant	0 to 1 s	0.01 s	0.3 s		738	
	288	G402	Droop function activation selection	0 to 2, 10, 11, 20 to 22	1	0		738	
—	289	M431	Inverter output terminal filter	5 to 50 ms, 9999	1 ms	9999		473	
—	290	M044	Monitor negative output selection	0 to 7	1	0		446, 457	

Function	Pr.	Pr. group	Name	Setting range	Minimum setting increments	Initial value		Refer to page	Customer setting
						FM	CA		
—	291	D100	Pulse train I/O selection	[FM type] 0, 1, 10, 11, 20, 21, 100 [CA type] 0, 1	1	0		406, 457	
—	292	A110 F500	Automatic acceleration/deceleration	0, 1, 3, 5 to 8, 11	1	0		384, 387, 572	
—	293	F513	Acceleration/deceleration separate selection	0 to 2	1	0		384	
—	294	A785	UV avoidance voltage gain	0 to 200%	0.1%	100%		642	
—	295	E201	Frequency change increment amount setting	0, 0.01, 0.1, 1, 10,	0.01	0		342	
Password	296	E410	Password lock level	0 to 6, 99, 100 to 106, 199, 9999	1	9999		348	
	297	E411	Password lock/unlock	(0 to 5), 1000 to 9998, 9999	1	9999		348	
—	298	A711	Frequency search gain	0 to 32767, 9999	1	9999		532, 638	
—	299	A701	Rotation direction detection selection at restarting	0, 1, 9999	1	0		628	
CC-Link IE	313 <sup>*17</sup>	M410	DO0 output selection	0 to 8, 10 to 20, 22, 25 to 28, 30 to 36, 38 to 57, 60, 61, 63, 64, 68, 70, 79, 80, 84 to 99, 100 to 108, 110 to 116, 120, 122, 125 to 128, 130 to 136, 138 to 157, 160, 161, 163, 164, 168, 170, 179, 180, 184 to 199, 200 to 208, 211 to 213, 247, 248, 300 to 308, 311 to 313, 347, 348, 9999	1	9999		473	
	314 <sup>*17</sup>	M411	DO1 output selection		1	9999		473	
	315 <sup>*17</sup>	M412	DO2 output selection		1	9999		473	
	316 <sup>*16</sup>	M413	DO3 output selection		1	9999		473	
	317 <sup>*16</sup>	M414	DO4 output selection		1	9999		473	
	318 <sup>*16</sup>	M415	DO5 output selection		1	9999		473	
	319 <sup>*16</sup>	M416	DO6 output selection		1	9999		473	
	320 <sup>*16</sup>	M420	RA1 output selection		1	9999		473	
	321 <sup>*16</sup>	M421	RA2 output selection		1	9999		473	
	322 <sup>*16</sup>	M422	RA3 output selection		1	9999		473	
—	328	E310	Inverter/converter switching 	0 to 9999	1	0		*18	

Function	Pr.	Pr. group	Name	Setting range	Minimum setting increments	Initial value		Refer to page	Customer setting
						FM	CA		
RS-485 communication	331	N030	RS-485 communication station number	0 to 31 (0 to 247)	1	0		670	
	332	N031	RS-485 communication speed	3, 6, 12, 24, 48, 96, 192, 384, 576, 768, 1152	1	96		670	
	333	—	RS-485 communication stop bit length / data length	0, 1, 10, 11	1	1		670	
		N032	RS-485 communication data length	0, 1	1	0			
		N033	RS-485 communication stop bit length	0, 1	1	1			
	334	N034	RS-485 communication parity check selection	0 to 2	1	2		670	
	335	N035	RS-485 communication retry count	0 to 10, 9999	1	1		670	
	336	N036	RS-485 communication check time interval	0 to 999.8 s, 9999	0.1 s	0 s		670	
	337	N037	RS-485 communication waiting time setting	0 to 150 ms, 9999	1 ms	9999		670	
	338	D010	Communication operation command source	0, 1	1	0		400	
	339	D011	Communication speed command source	0 to 2	1	0		400	
	340	D001	Communication startup mode selection	0 to 2, 10, 12	1	0		398	
	341	N038	RS-485 communication CR/LF selection	0 to 2	1	1		670	
	342	N001	Communication EEPROM write selection	0, 1	1	0		663	
	343	N080	Communication error count	—	1	0		686	
—	349 <sup>*17</sup>	—	Communication reset selection/Ready bit status selection	0, 1, 100, 101, 1000, 1001, 1100, 1101, 10000, 10001, 10100, 10101, 11000, 11001, 11100, 11101	1	0		663	
		N010	Communication reset selection	0, 1	1	0		663	
		N240	Ready bit status selection	0, 1	1	0		663	
		N241	Reset selection after inverter faults are cleared	0, 1	1	0		893	
		N242	DriveControl writing restriction selection	0, 1	1	0		893	

Function	Pr.	Pr. group	Name	Setting range	Minimum setting increments	Initial value		Refer to page	Customer setting
						FM	CA		
Orientation control	350 <sup>*g</sup>	A510	Stop position command selection	0, 1, 9999	1	9999		585	
	351 <sup>*g</sup>	A526	Orientation speed	0 to 30 Hz	0.01 Hz.	2 Hz		585	
	352 <sup>*g</sup>	A527	Creep speed	0 to 10 Hz	0.01 Hz.	0.5 Hz		585	
	353 <sup>*g</sup>	A528	Creep switchover position	0 to 16383	1	511		585	
	354 <sup>*g</sup>	A529	Position loop switchover position	0 to 8191	1	96		585	
	355 <sup>*g</sup>	A530	DC injection brake start position	0 to 255	1	5		585	
	356 <sup>*g</sup>	A531	Internal stop position command	0 to 16383	1	0		585	
	357 <sup>*g</sup>	A532	Orientation in-position zone	0 to 255	1	5		585	
	358 <sup>*g</sup>	A533	Servo torque selection	0 to 13	1	1		585	
	359 <sup>*g</sup>	C141	Encoder rotation direction	0, 1, 100, 101	1	1		94, 585, 736	
	360 <sup>*g</sup>	A511	16-bit data selection	0 to 127	1	0		585	
	361 <sup>*g</sup>	A512	Position shift	0 to 16383	1	0		585	
	362 <sup>*g</sup>	A520	Orientation position loop gain	0.1 to 100	0, 1	1.0		585	
	363 <sup>*g</sup>	A521	Completion signal output delay time	0 to 5 s	0.1 s	0.5 s		585	
	364 <sup>*g</sup>	A522	Encoder stop check time	0 to 5 s	0.1 s	0.5 s		585	
	365 <sup>*g</sup>	A523	Orientation limit	0 to 60 s, 9999	1 s	9999		585	
366 <sup>*g</sup>	A524	Recheck time	0 to 5 s, 9999	0.1 s	9999		585		
Encoder feedback	367 <sup>*g</sup>	G240	Speed feedback range	0 to 590 Hz, 9999	0.01 Hz	9999		736	
	368 <sup>*g</sup>	G241	Feedback gain	0 to 100	0.1	1		736	
	369 <sup>*g</sup>	C140	Number of encoder pulses	0 to 4096	1	1024		94, 585, 736	
—	373	C142	Encoder position tuning setting/status	0, 1	1	0		542	
—	374	H800	Overspeed detection level	0 to 590 Hz, 9999	0.01 Hz	9999		443	
—	376 <sup>*g</sup>	C148	Encoder signal loss detection enable/disable selection	0, 1	1	0		561	
S-pattern acceleration/deceleration C	380	F300	Acceleration S-pattern 1	0 to 50%	1%	0%		372	
	381	F301	Deceleration S-pattern 1	0 to 50%	1%	0%		372	
	382	F302	Acceleration S-pattern 2	0 to 50%	1%	0%		372	
	383	F303	Deceleration S-pattern 2	0 to 50%	1%	0%		372	
Pulse train input	384	D101	Input pulse division scaling factor	0 to 250	1	0		406	
	385	D110	Frequency for zero input pulse	0 to 590 Hz	0.01 Hz	0 Hz		406	
	386	D111	Frequency for maximum input pulse	0 to 590 Hz	0.01 Hz	60 Hz	50 Hz	406	



Function	Pr.	Pr. group	Name	Setting range	Minimum setting increments	Initial value		Refer to page	Customer setting
						FM	CA		
Orientation control	393 <sup>*9</sup>	A525	Orientation selection	0 to 2, 10 to 12	1	0		585	
	394 <sup>*9</sup>	A540	Number of machine side gear teeth	0 to 32767	1	1		585	
	395 <sup>*9</sup>	A541	Number of motor side gear teeth	0 to 32767	1	1		585	
	396 <sup>*9</sup>	A542	Orientation speed gain (P term)	0 to 1000	1	60		585	
	397 <sup>*9</sup>	A543	Orientation speed integral time	0 to 20 s	0.001 s	0.333 s		585	
	398 <sup>*9</sup>	A544	Orientation speed gain (D term)	0 to 100	0.1	1		585	
	399 <sup>*9</sup>	A545	Orientation deceleration ratio	0 to 1000	1	20		585	
I	413 <sup>*9</sup>	M601	Encoder pulse division ratio	1 to 32767	1	1		495	
PLC	414	A800	PLC function operation selection	0 to 2, 11, 12	1	0		646	
	415	A801	Inverter operation lock mode setting	0, 1	1	0		646	
	416	A802	Pre-scale function selection	0 to 5	1	0		646	
	417	A803	Pre-scale setting value	0 to 32767	1	1		646	
Position control	419	B000	Position command source selection	0 to 2, 10, 100, 110, 200, 210, 300, 310, 1110, 1310	1	0		303, 319	
	420	B001	Command pulse scaling factor numerator (electronic gear numerator)	1 to 32767	1	1		325	
	421	B002	Command pulse multiplication denominator (electronic gear denominator)	1 to 32767	1	1		325	
	422	B003	Position control gain	0 to 150 s <sup>-1</sup>	1 s <sup>-1</sup>	25 s <sup>-1</sup>		328	
	423	B004	Position feed forward gain	0 to 100%	1%	0%		328	
	424	B005	Position command acceleration/deceleration time constant	0 to 50 s	0.001s	0 s		325	
	425	B006	Position feed forward command filter	0 to 5 s	0.001 s	0 s		328	
	426	B007	In-position width	0 to 32767 pulses	1 pulse	100 pulses		327	
	427	B008	Excessive level error	0 to 400k pulses, 9999	1k pulses	40k pulses		327	
	428	B009	Command pulse selection	0 to 5	1	0		319	
	429	B010	Clear signal selection	0, 1	1	1		320	
	430	B011	Pulse monitor selection	0 to 5, 12, 13, 100 to 105, 112, 113, 1000 to 1005, 1012, 1013, 1100 to 1105, 1112, 1113, 2000 to 2005, 2012, 2013, 2100 to 2105, 2112, 2113, 3000 to 3005, 3012, 3013, 3100 to 3105, 3112, 3113, 8888, 9999	1	9999		321	
	I	432 <sup>*9</sup>	D120	Pulse train torque command bias	0 to 400%	1%	0%		283
I	433 <sup>*9</sup>	D121	Pulse train torque command gain	0 to 400%	1%	150%		283	
CC-Link IE	434 <sup>*17</sup>	N110	Network number (CC-Link IE)	0 to 255	1	0		699	
	435 <sup>*17</sup>	N111	Station number (CC-Link IE)	0 to 255	1	0		699	
I	446	B012	Model position control gain	0 to 150 s <sup>-1</sup>	1 s <sup>-1</sup>	25 s <sup>-1</sup>		328	

Function	Pr.	Pr. group	Name	Setting range	Minimum setting increments	Initial value		Refer to page	Customer setting
						FM	CA		
Second motor constant	450	C200	Second applied motor	0, 1, 3 to 6, 13 to 16, 20, 23, 24, 30, 33, 34, 40, 43, 44, 50, 53, 54, 70, 73, 74, 330, 333, 334, 8090, 8093, 8094, 9090, 9093, 9094, 9999	1		9999	528	
	451	G300	Second motor control method selection	0 to 6, 10 to 14, 20, 100 to 106, 110 to 114, 9999	1		9999	221	
	453	C201	Second motor capacity	0.4 to 55 kW, 9999 <sup>*2</sup> 0 to 3600 kW, 9999 <sup>*3</sup>	0.01 kW <sup>*2</sup> 0.1 kW <sup>*3</sup>		9999	532, 551	
	454	C202	Number of second motor poles	2, 4, 6, 8, 10, 12, 9999	1		9999	532, 551	
	455	C225	Second motor excitation current	0 to 500 A, 9999 <sup>*2</sup> 0 to 3600 A, 9999 <sup>*3</sup>	0.01 A <sup>*2</sup> 0.1 A <sup>*3</sup>		9999	532	
	456	C204	Rated second motor voltage	0 to 1000 V	0.1 V		200 V <sup>*7</sup> 400 V <sup>*8</sup>	532, 551	
	457	C205	Rated second motor frequency	10 to 400 Hz, 9999	0.01 Hz		9999	532, 551	
	458	C220	Second motor constant (R1)	0 to 50 Ω, 9999 <sup>*2</sup> 0 to 400 mΩ, 9999 <sup>*3</sup>	0.001Ω <sup>*2</sup> 0.01mΩ <sup>*3</sup>		9999	532, 551, 638	
	459	C221	Second motor constant (R2)	0 to 50 Ω, 9999 <sup>*2</sup> 0 to 400 mΩ, 9999 <sup>*3</sup>	0.001Ω <sup>*2</sup> 0.01mΩ <sup>*3</sup>		9999	532	
	460	C222	Second motor constant (L1) / d-axis inductance (Ld)	0 to 6000 mH, 9999 <sup>*2</sup> 0 to 400 mH, 9999 <sup>*3</sup>	0.1mH <sup>*2</sup> 0.01mH <sup>*3</sup>		9999	532, 551	
	461	C223	Second motor constant (L2) / q-axis inductance (Lq)	0 to 6000 mH, 9999 <sup>*2</sup> 0 to 400 mH, 9999 <sup>*3</sup>	0.1mH <sup>*2</sup> 0.01mH <sup>*3</sup>		9999	532, 551	
	462	C224	Second motor constant (X)	0 to 100%, 9999	0.1% <sup>*2</sup> 0.01% <sup>*3</sup>		9999	532	
	463	C210	Second motor auto tuning setting/status	0, 1, 11, 101	1		0	532, 551, 638	

Function	Pr.	Pr. group	Name	Setting range	Minimum setting increments	Initial value		Refer to page	Customer setting
						FM	CA		
Simple position control	464	B020	Digital position control sudden stop deceleration time	0 to 360 s	0.1 s	0 s		303	
	465	B021	First target position lower 4 digits	0 to 9999	1	0		303	
	466	B022	First target position upper 4 digits	0 to 9999	1	0		303	
	467	B023	Second target position lower 4 digits	0 to 9999	1	0		303	
	468	B024	Second target position upper 4 digits	0 to 9999	1	0		303	
	469	B025	Third target position lower 4 digits	0 to 9999	1	0		303	
	470	B026	Third target position upper 4 digits	0 to 9999	1	0		303	
	471	B027	Fourth target position lower 4 digits	0 to 9999	1	0		303	
	472	B028	Fourth target position upper 4 digits	0 to 9999	1	0		303	
	473	B029	Fifth target position lower 4 digits	0 to 9999	1	0		303	
	474	B030	Fifth target position upper 4 digits	0 to 9999	1	0		303	
	475	B031	Sixth target position lower 4 digits	0 to 9999	1	0		303	
	476	B032	Sixth target position upper 4 digits	0 to 9999	1	0		303	
	477	B033	Seventh target position lower 4 digits	0 to 9999	1	0		303	
	478	B034	Seventh target position upper 4 digits	0 to 9999	1	0		303	
	479	B035	Eighth target position lower 4 digits	0 to 9999	1	0		303	
	480	B036	Eighth target position upper 4 digits	0 to 9999	1	0		303	
	481	B037	Ninth target position lower 4 digits	0 to 9999	1	0		303	
	482	B038	Ninth target position upper 4 digits	0 to 9999	1	0		303	
	483	B039	Tenth target position lower 4 digits	0 to 9999	1	0		303	
	484	B040	Tenth target position upper 4 digits	0 to 9999	1	0		303	
	485	B041	Eleventh target position lower 4 digits	0 to 9999	1	0		303	
	486	B042	Eleventh target position upper 4 digits	0 to 9999	1	0		303	
	487	B043	Twelfth target position lower 4 digits	0 to 9999	1	0		303	
	488	B044	Twelfth target position upper 4 digits	0 to 9999	1	0		303	
	489	B045	Thirteenth target position lower 4 digits	0 to 9999	1	0		303	
	490	B046	Thirteenth target position upper 4 digits	0 to 9999	1	0		303	
	491	B047	Fourteenth target position lower 4 digits	0 to 9999	1	0		303	
	492	B048	Fourteenth target position upper 4 digits	0 to 9999	1	0		303	
	493	B049	Fifteenth target position lower 4 digits	0 to 9999	1	0		303	
494	B050	Fifteenth target position upper 4 digits	0 to 9999	1	0		303		

Function	Pr.	Pr. group	Name	Setting range	Minimum setting increments	Initial value		Refer to page	Customer setting
						FM	CA		
Remote output	495	M500	Remote output selection	0, 1, 10, 11	1	0		489	
	496	M501	Remote output data 1	0 to 4095	1	0		489	
	497	M502	Remote output data 2	0 to 4095	1	0		489	
—	498	A804	PLC function flash memory clear	0, 9696 (0 to 9999)	1	0		646	
—	500 <sup>*17</sup>	N011	Communication error execution waiting time	0 to 999.8 s	0.1 s	0 s		663	
—	501 <sup>*17</sup>	N012	Communication error occurrence count display	0	1	0		663	
—	502	N013	Stop mode selection at communication error	0 to 4, 11, 12	1	0		663	
Maintenance	503	E710	Maintenance timer 1	0 (1 to 9998)	1	0		363	
	504	E711	Maintenance timer 1 warning output set time	0 to 9998, 9999	1	9999		363	
—	505	M001	Speed setting reference	1 to 590 Hz	0.01 Hz	60 Hz	50 Hz	444	
—	506 <sup>*15</sup>	E705	Display estimated main circuit capacitor residual life	(0 to 100%)	1%	100%		359	
—	507	E706	Display/reset ABC1 relay contact life	0 to 100%	1%	100%		359	
—	508	E707	Display/reset ABC2 relay contact life	0 to 100%	1%	100%		359	
S-pattern acceleration/deceleration D	516	F400	S-pattern time at a start of acceleration	0.1 to 2.5 s	0.1 s	0.1 s		372	
	517	F401	S-pattern time at a completion of acceleration	0.1 to 2.5 s	0.1 s	0.1 s		372	
	518	F402	S-pattern time at a start of deceleration	0.1 to 2.5 s	0.1 s	0.1 s		372	
	519	F403	S-pattern time at a completion of deceleration	0.1 to 2.5 s	0.1 s	0.1 s		372	
—	522	G105	Output stop frequency	0 to 590 Hz, 9999	0.01 Hz	9999		720	
—	539	N002	MODBUS RTU communication check time interval	0 to 999.8 s, 9999	0.1 s	9999		686	
—	541 <sup>*17</sup>	N100	Frequency command sign selection	0, 1	1	0		699	
USB	547	N040	USB communication station number	0 to 31	1	0		701	
	548	N041	USB communication check time interval	0 to 999.8 s, 9999	0.1 s	9999		701	
Communication	549	N000	Protocol selection	0, 1	1	0		663	
	550	D012	NET mode operation command source selection	0, 1, 9999	1	9999		400	
	551	D013	PU mode operation command source selection	1 to 3, 9999	1	9999		400	
—	552	H429	Frequency jump range	0 to 30 Hz, 9999	0.01 Hz	9999		429	
PID control	553	A603	PID deviation limit	0 to 100%, 9999	0.1%	9999		601	
	554	A604	PID signal operation selection	0 to 3, 10 to 13	1	0		601	

Function	Pr.	Pr. group	Name	Setting range	Minimum setting increments	Initial value		Refer to page	Customer setting
						FM	CA		
Average current monitoring	555	E720	Current average time	0.1 to 1 s	0.1 s	1 s		363	
	556	E721	Data output mask time	0 to 20 s	0.1 s	0 s		363	
	557	E722	Current average value monitor signal output reference current	0 to 500 A <sup>*2</sup> 0 to 3600 A <sup>*3</sup>	0.01 A <sup>*2</sup> 0.1 A <sup>*3</sup>	Inverter rated current		363	
—	560	A712	Second frequency search gain	0 to 32767, 9999	1	9999		532, 638	
—	561	H020	PTC thermistor protection level	0.5 to 30 kΩ, 9999	0.01 kΩ	9999		415	
—	563	M021	Energization time carrying-over times	(0 to 65535)	1	0		446	
—	564	M031	Operating time carrying-over times	(0 to 65535)	1	0		446	
—	565	G301	Second motor excitation current break point	0 to 400 Hz, 9999	0.01 Hz	9999		711	
—	566	G302	Second motor excitation current low-speed scaling factor	0 to 300%, 9999	0.1%	9999		711	
Second motor constant	569	G942	Second motor speed control gain	0 to 200%, 9999	0.1%	9999		228	
Multiple rating	570	E301	Multiple rating setting	0 to 3 <sup>*11*12</sup> 1, 2 <sup>*13</sup>	1	2		343	
—	571	F103	Holding time at a start	0 to 10 s, 9999	0.1 s	9999		381	
—	573	A680 T052	4 mA input check selection	1 to 4, 11 to 14, 21 to 24, 9999	1	9999		517	
—	574	C211	Second motor online auto tuning	0 to 2	1	0		558	
PID control	575	A621	Output interruption detection time	0 to 3600 s, 9999	0.1 s	1 s		601	
	576	A622	Output interruption detection level	0 to 590 Hz	0.01 Hz	0 Hz		601	
	577	A623	Output interruption cancel level	900 to 1100%	0.1%	1000%		601	
Traverse	592	A300	Traverse function selection	0 to 2	1	0		582	
	593	A301	Maximum amplitude amount	0 to 25%	0.1%	10%		582	
	594	A302	Amplitude compensation amount during deceleration	0 to 50%	0.1%	10%		582	
	595	A303	Amplitude compensation amount during acceleration	0 to 50%	0.1%	10%		582	
	596	A304	Amplitude acceleration time	0.1 to 3600 s	0.1 s	5 s		582	
	597	A305	Amplitude deceleration time	0.1 to 3600 s	0.1 s	5 s		582	
—	598	H102	Undervoltage level	175 to 215 VDC <sup>*7</sup> /350 to 430 VDC <sup>*8</sup> , 9999	0.1 V	9999		425	
—	599	T721	X10 terminal input selection	0, 1	1	0 <sup>*11*13</sup> 1 <sup>*12</sup>		724	

Function	Pr.	Pr. group	Name	Setting range	Minimum setting increments	Initial value		Refer to page	Customer setting
						FM	CA		
Electronic thermal O/L relay	600	H001	First free thermal reduction frequency 1	0 to 590 Hz, 9999	0.01 Hz	9999		415	
	601	H002	First free thermal reduction ratio 1	1 to 100%	1%	100%		415	
	602	H003	First free thermal reduction frequency 2	0 to 590 Hz, 9999	0.01 Hz	9999		415	
	603	H004	First free thermal reduction ratio 2	1 to 100%	1%	100%		415	
	604	H005	First free thermal reduction frequency 3	0 to 590 Hz, 9999	0.01 Hz	9999		415	
—	606	T722	Power failure stop external signal input selection	0, 1	1	1		642	
—	607	H006	Motor permissible load level	110 to 250%	1%	150%		415	
—	608	H016	Second motor permissible load level	110 to 250%, 9999	1%	9999		415	
PID control	609	A624	PID set point/deviation input selection	1 to 5	1	2		601, 622	
	610	A625	PID measured value input selection	1 to 5	1	3		601, 622	
—	611	F003	Acceleration time at a restart	0 to 3600 s, 9999	0.1 s	9999		628, 635	
—	617	G080	Reverse rotation excitation current low-speed scaling factor	0 to 300%, 9999	0.1%	9999		711	
Cumulative pulse monitoring	635 <sup>9</sup>	M610	Cumulative pulse clear signal selection	0 to 3	1	0		321	
	636 <sup>9</sup>	M611	Cumulative pulse division scaling factor	1 to 16384	1	1		321	
	637 <sup>9</sup>	M612	Control terminal option-Cumulative pulse division scaling factor	1 to 16384	1	1		321	
	638 <sup>9</sup>	M613	Cumulative pulse storage	0 to 3	1	0		321	
Brake sequence	639	A108	Brake opening current selection	0, 1	1	0		572	
	640	A109	Brake operation frequency selection	0, 1	1	0		572	
	641	A130	Second brake sequence operation selection	0, 7, 8, 9999	1	0		572	
	642	A120	Second brake opening frequency	0 to 30 Hz	0.01 Hz.	3 Hz		572	
	643	A121	Second brake opening current	0 to 400%	0.1%	130%		572	
	644	A122	Second brake opening current detection time	0 to 2 s	0.1 s	0.3 s		572	
	645	A123	Second brake operation time at start	0 to 5 s	0.1 s	0.3 s		572	
	646	A124	Second brake operation frequency	0 to 30 Hz	0.01 Hz.	6 Hz		572	
	647	A125	Second brake operation time at stop	0 to 5 s	0.1 s	0.3 s		572	
	648	A126	Second deceleration detection function selection	0, 1	1	0		572	
	650	A128	Second brake opening current selection	0, 1	1	0		572	
	651	A129	Second brake operation frequency selection	0, 1	1	0		572	

Function	Pr.	Pr. group	Name	Setting range	Minimum setting increments	Initial value		Refer to page	Customer setting
						FM	CA		
Speed smoothing control	653	G410	Speed smoothing control	0 to 200%	0.1%	0%		741	
	654	G411	Speed smoothing cutoff frequency	0 to 120 Hz	0.01 Hz	20 Hz		741	
Analog remote output	655	M530	Analog remote output selection	0, 1, 10, 11	1	0		490	
	656	M531	Analog remote output 1	800 to 1200%	0.1%	1000%		490	
	657	M532	Analog remote output 2	800 to 1200%	0.1%	1000%		490	
	658	M533	Analog remote output 3	800 to 1200%	0.1%	1000%		490	
	659	M534	Analog remote output 4	800 to 1200%	0.1%	1000%		490	
Increased magnetic excitation deceleration	660	G130	Increased magnetic excitation deceleration operation selection	0, 1	1	0		735	
	661	G131	Magnetic excitation increase rate	0 to 40%, 9999	0.1%	9999		735	
	662	G132	Increased magnetic excitation current level	0 to 300%	0.1%	100%		735	
—	663	M060	Control circuit temperature signal output level	0 to 100°C	1°C	0°C		494	
—	665	G125	Regeneration avoidance frequency gain	0 to 200%	0.1%	100%		732	
—	668	A786	Power failure stop frequency gain	0 to 200%	0.1%	100%		642	
—	673	G060	SF-PR slip amount adjustment operation selection	2 to 4, 6, 9999	1	9999		714	
—	674	G061	SF-PR slip amount adjustment gain	0 to 500%	0.1%	100%		714	
—	675	A805	User parameter auto storage function selection	1, 9999	1	9999		646	
Second droop control	679	G420	Second droop gain	0 to 100%, 9999	0.1%	9999		738	
	680	G421	Second droop filter time constant	0 to 1 s, 9999	0.01 s	9999		738	
	681	G422	Second droop function activation selection	0 to 2, 10, 11, 20 to 22, 9999	1	9999		738	
	682	G423	Second droop break point gain	0.1 to 100%, 9999	0.1%	9999		738	
	683	G424	Second droop break point torque	0.1 to 100%, 9999	0.1%	9999		738	
—	684	C000	Tuning data unit switchover	0, 1	1	0		532, 551	
Maintenance	686	E712	Maintenance timer 2	0 (1 to 9998)	1	0		363	
	687	E713	Maintenance timer 2 warning output set time	0 to 9998, 9999	1	9999		363	
	688	E714	Maintenance timer 3	0 (1 to 9998)	1	0		363	
	689	E715	Maintenance timer 3 warning output set time	0 to 9998, 9999	1	9999		363	
—	690	H881	Deceleration check time	0 to 3600 s, 9999	0.1 s	1 s		269	

Function	Pr.	Pr. group	Name	Setting range	Minimum setting increments	Initial value		Refer to page	Customer setting
						FM	CA		
Electronic thermal O/L relay	692	H011	Second free thermal reduction frequency 1	0 to 590 Hz, 9999	0.01 Hz	9999		415	
	693	H012	Second free thermal reduction ratio 1	1 to 100%	1%	100%		415	
	694	H013	Second free thermal reduction frequency 2	0 to 590 Hz, 9999	0.01 Hz	9999		415	
	695	H014	Second free thermal reduction ratio 2	1 to 100%	1%	100%		415	
	696	H015	Second free thermal reduction frequency 3	0 to 590 Hz, 9999	0.01 Hz	9999		415	
—	699	T740	Input terminal filter	5 to 50 ms, 9999	1 ms	9999		521	
Motor constant	702	C106	Maximum motor frequency	0 to 400 Hz, 9999	0.01 Hz	9999		551	
	706	C130	Induced voltage constant (phi f)	0 to 5000 mV (rad/s), 9999	0.1 mV (rad/s)	9999		551	
	707	C107	Motor inertia (integer)	10 to 999, 9999	1	9999		551	
	711	C131	Motor Ld decay ratio	0 to 100%, 9999	0.1%	9999		551	
	712	C132	Motor Lq decay ratio	0 to 100%, 9999	0.1%	9999		551	
	717	C182	Starting resistance tuning compensation	0 to 200%, 9999	0.1%	9999		551	
	721	C185	Starting magnetic pole position detection pulse width	0 to 6000 μs, 10000 to 16000 μs, 9999	1 μs	9999		551	
	724	C108	Motor inertia (exponent)	0 to 7, 9999	1	9999		551	
	725	C133	Motor protection current level	100 to 500%, 9999	0.1%	9999		551	
	738	C230	Second motor induced voltage constant (phi f)	0 to 5000 mV (rad/s), 9999	0.1 mV (rad/s)	9999		551	
	739	C231	Second motor Ld decay ratio	0 to 100%, 9999	0.1%	9999		551	
	740	C232	Second motor Lq decay ratio	0 to 100%, 9999	0.1%	9999		551	
	741	C282	Second starting resistance tuning compensation	0 to 200%, 9999	0.1%	9999		551	
	742	C285	Second motor magnetic pole position detection pulse width	0 to 6000 μs, 10000 to 16000 μs, 9999	1 μs	9999		551	
	743	C206	Second motor maximum frequency	0 to 400 Hz, 9999	0.01 Hz	9999		551	
	744	C207	Second motor inertia (integer)	10 to 999, 9999	1	9999		551	
	745	C208	Second motor inertia (exponent)	0 to 7, 9999	1	9999		551	
746	C233	Second motor protection current level	100 to 500%, 9999	0.1%	9999		551		
—	747	G350	Second motor low-speed range torque characteristic selection	0, 9999	1	9999		233	
PID control	753	A650	Second PID action selection	0, 10, 11, 20, 21, 50, 51, 60, 61, 70, 71, 80, 81, 90, 91, 100, 101, 1000, 1001, 1010, 1011, 2000, 2001, 2010, 2011	1	0		601	
	754	A652	Second PID control automatic switchover frequency	0 to 590 Hz, 9999	0.01 Hz	9999		601	
	755	A651	Second PID action set point	0 to 100%, 9999	0.01%	9999		601	
	756	A653	Second PID proportional band	0.1 to 1000%, 9999	0.1%	100%		601	
	757	A654	Second PID integral time	0.1 to 3600 s, 9999	0.1 s	1 s		601	
	758	A655	Second PID differential time	0.01 to 10 s, 9999	0.01 s	9999		601	
	759	A600	PID unit selection	0 to 43, 9999	1	9999		615	



Function	Pr.	Pr. group	Name	Setting range	Minimum setting increments	Initial value		Refer to page	Customer setting
						FM	CA		
PID Pre-charge	760	A616	Pre-charge fault selection	0, 1	1	0		618	
	761	A617	Pre-charge ending level	0 to 100%, 9999	0.1%	9999		618	
	762	A618	Pre-charge ending time	0 to 3600 s, 9999	0.1 s	9999		618	
	763	A619	Pre-charge upper detection level	0 to 100%, 9999	0.1%	9999		618	
	764	A620	Pre-charge time limit	0 to 3600 s, 9999	0.1 s	9999		618	
	765	A656	Second pre-charge fault selection	0, 1	1	0		618	
	766	A657	Second pre-charge ending level	0 to 100%, 9999	0.1%	9999		618	
	767	A658	Second pre-charge ending time	0 to 3600 s, 9999	0.1 s	9999		618	
	768	A659	Second pre-charge upper detection level	0 to 100%, 9999	0.1%	9999		618	
	769	A660	Second pre-charge time limit	0 to 3600 s, 9999	0.1 s	9999		618	
Monitoring	774	M101	Operation panel monitor selection 1	1 to 3, 5 to 14, 17 to 20, 22 to 36, 38 to 46, 50 to 57, 61, 62, 64, 67, 71 to 75, 87 to 98, 100, 9999	1	9999		446	
	775	M102	Operation panel monitor selection 2		1	9999		446	
	776	M103	Operation panel monitor selection 3		1	9999		446	
—	777	A681 T053	4 mA input fault operation frequency	0 to 590 Hz, 9999	0.01 Hz	9999		517	
—	778	A682 T054	4 mA input check filter	0 to 10 s	0.01 s	0 s		517	
—	779	N014	Operation frequency during communication error	0 to 590 Hz, 9999	0.01 Hz	9999		663	
—	788	G250	Low speed range torque characteristic selection	0, 9999	1	9999		233	
—	791	F070	Acceleration time in low-speed range	0 to 3600 s, 9999	0.1 s	9999		367	
—	792	F071	Deceleration time in low-speed range	0 to 3600 s, 9999	0.1 s	9999		367	
—	799	M520	Pulse increment setting for output power	0.1, 1, 10, 100, 1000 kWh	0.1 kWh	1 kWh		493	
—	800	G200	Control method selection	0 to 6, 9 to 14, 20, 100 to 106, 109 to 114	1	20		221	
—	801	H704	Output limit level	0 to 400%, 9999	0.1%	9999		245, 283	
—	802	G102	Pre-excitation selection	0, 1	1	0		715	
Torque command	803	G210	Constant output range torque characteristic selection	0 to 2, 10, 11	1	0		245, 283	
	804	D400	Torque command source selection	0 to 6	1	0		283	
	805	D401	Torque command value (RAM)	600 to 1400%	1%	1000%		283	
	806	D402	Torque command value (RAM, EEPROM)	600 to 1400%	1%	1000%		283	
Speed limit	807	H410	Speed limit selection	0 to 2	1	0		287	
	808	H411	Forward rotation speed limit/speed limit	0 to 400 Hz	0.01 Hz.	60 Hz	50 Hz	287	
	809	H412	Reverse rotation speed limit/reverse-side speed limit	0 to 400 Hz, 9999	0.01 Hz	9999		287	

Function	Pr.	Pr. group	Name	Setting range	Minimum setting increments	Initial value		Refer to page	Customer setting
						FM	CA		
Torque limit	810	H700	Torque limit input method selection	0 to 2	1	0		245	
	811	D030	Set resolution switchover	0, 1, 10, 11	1	0		245, 444	
	812	H701	Torque limit level (regeneration)	0 to 400%, 9999	0.1%	9999		245	
	813	H702	Torque limit level (3rd quadrant)	0 to 400%, 9999	0.1%	9999		245	
	814	H703	Torque limit level (4th quadrant)	0 to 400%, 9999	0.1%	9999		245	
	815	H710	Torque limit level 2	0 to 400%, 9999	0.1%	9999		245	
	816	H720	Torque limit level during acceleration	0 to 400%, 9999	0.1%	9999		245	
	817	H721	Torque limit level during deceleration	0 to 400%, 9999	0.1%	9999		245	
Easy gain tuning	818	C112	Easy gain tuning response level setting	1 to 15	1	2		254	
	819	C113	Easy gain tuning selection	0 to 2	1	0		254	
Adjustment	820	G211	Speed control P gain 1	0 to 1000%	1%	60%		254	
	821	G212	Speed control integral time 1	0 to 20 s	0.001 s	0.333 s		254	
	822	T003	Speed setting filter 1	0 to 5 s, 9999	0.001 s	9999		503	
	823 <sup>g</sup>	G215	Speed detection filter 1	0 to 0.1 s	0.001 s	0.001 s		332	
	824	G213	Torque control P gain 1 (current loop proportional gain)	0 to 500%	1%	100%		294, 333	
	825	G214	Torque control integral time 1 (current loop integral time)	0 to 500 ms	0.1 ms	5 ms		294, 333	
	826	T004	Torque setting filter 1	0 to 5 s, 9999	0.001 s	9999		503	
	827	G216	Torque detection filter 1	0 to 0.1 s	0.001 s	0 s		332	
	828	G224	Model speed control gain	0 to 1000%	1%	60%		263, 328	
	829 <sup>g</sup>	A546	Number of machine end encoder pulses	0 to 4096, 9999	1	9999		585	
	830	G311	Speed control P gain 2	0 to 1000%, 9999	1%	9999		254	
	831	G312	Speed control integral time 2	0 to 20 s, 9999	0.001 s	9999		254	
	832	T005	Speed setting filter 2	0 to 5 s, 9999	0.001 s	9999		503	
	833 <sup>g</sup>	G315	Speed detection filter 2	0 to 0.1 s, 9999	0.001 s	9999		332	
	834	G313	Torque control P gain 2 (current loop proportional gain)	0 to 500%, 9999	1%	9999		294	
	835	G314	Torque control integral time 2 (current loop integral time)	0 to 500 ms, 9999	0.1 ms	9999		294	
	836	T006	Torque setting filter 2	0 to 5 s, 9999	0.001 s	9999		503	
	837	G316	Torque detection filter 2	0 to 0.1 s, 9999	0.001 s	9999		332	
Torque bias	840	G230	Torque bias selection	0 to 3, 24, 25, 9999	1	9999		265	
	841	G231	Torque bias 1	600 to 1400%, 9999	1%	9999		265	
	842	G232	Torque bias 2	600 to 1400%, 9999	1%	9999		265	
	843	G233	Torque bias 3	600 to 1400%, 9999	1%	9999		265	
	844	G234	Torque bias filter	0 to 5 s, 9999	0.001 s	9999		265	
	845	G235	Torque bias operation time	0 to 5 s, 9999	0.01 s	9999		265	
	846	G236	Torque bias balance compensation	0 to 10 V, 9999	0.1 V	9999		265	
	847	G237	Fall-time torque bias terminal 1 bias	0 to 400%, 9999	1%	9999		265	
	848	G238	Fall-time torque bias terminal 1 gain	0 to 400%, 9999	1%	9999		265	

Function	Pr.	Pr. group	Name	Setting range	Minimum setting increments	Initial value		Refer to page	Customer setting
						FM	CA		
Additional function	849	T007	Analog input offset adjustment	0 to 200%	0.1%	100%		503	
	850	G103	Brake operation selection	0 to 2	1	0		715	
	851 <sup>*9</sup>	C240	Control terminal option- Number of encoder pulses	0 to 4096	1	2048		94	
	852 <sup>*9</sup>	C241	Control terminal option- Encoder rotation direction	0, 1, 100, 101	1	1		94	
	853 <sup>*9</sup>	H417	Speed deviation time	0 to 100 s	0.1 s	1 s		269	
	854	G217	Excitation ratio	0 to 100%	1%	100%		332	
	855 <sup>*9</sup>	C248	Control terminal option- Signal loss detection enable/ disable selection	0, 1	1	0		561	
	858	T040	Terminal 4 function assignment	0, 1, 4, 9999	1	0		245, 431, 500	
	859	C126	Torque current/Rated PM motor current	0 to 500 A, 9999 <sup>*2</sup>	0.01 A <sup>*2</sup>	9999		532, 551	
				0 to 3600 A, 9999 <sup>*3</sup>	0.1 A <sup>*3</sup>				
	860	C226	Second motor torque current/Rated PM motor current	0 to 500 A, 9999 <sup>*2</sup>	0.01 A <sup>*2</sup>	9999		532, 551	
				0 to 3600 A, 9999 <sup>*3</sup>	0.1 A <sup>*3</sup>				
	862 <sup>*9</sup>	C242	Encoder option selection	0, 1	1	0		226	
	863 <sup>*9</sup>	M600	Control terminal option- Encoder pulse division ratio	1 to 32767	1	1		495	
864	M470	Torque detection	0 to 400%	0.1%	150%		488		
865	M446	Low speed detection	0 to 590 Hz	0.01 Hz	1.5 Hz		484		
Indication	866	M042	Torque monitoring reference	0 to 400%	0.1%	150%		457	
—	867	M321	AM output filter	0 to 5 s	0.01 s	0.01 s		463	
—	868	T010	Terminal 1 function assignment	0 to 6, 9999	1	0		245, 431, 500	
—	869	M334	Current output filter	0 to 5 s	0.01 s	—	0.02 s	463	
—	870	M440	Speed detection hysteresis	0 to 5 Hz	0.01 Hz	0 Hz		484	
—	871 <sup>*9</sup>	C243	Control terminal option— Encoder position tuning setting/status	0, 1	1	0		542	
Protective function	872 <sup>*15</sup>	H201	Input phase loss protection selection	0, 1	1	0		426	
	873 <sup>*9</sup>	H415	Speed limit	0 to 400 Hz	0.01 Hz.	20 Hz		269	
	874	H730	OLT level setting	0 to 400%	0.1%	150%		245	
	875	H030	Fault definition	0, 1	1	0		422	
—	876 <sup>*9</sup>	H022	Thermal protector input	0, 1	1	1		415	
Control system	877	G220	Speed feed forward control/ model adaptive speed control selection	0 to 2	1	0		263, 328	
	878	G221	Speed feed forward filter	0 to 1 s	0.01 s	0 s		263	
	879	G222	Speed feed forward torque limit	0 to 400%	0.1%	150%		263	
	880	C114	Load inertia ratio	0 to 200 times	0.1 times	7 times		254, 263, 328	
	881	G223	Speed feed forward gain	0 to 1000%	1%	0%		263	

Function	Pr.	Pr. group	Name	Setting range	Minimum setting increments	Initial value		Refer to page	Customer setting
						FM	CA		
Regeneration avoidance	882	G120	Regeneration avoidance operation selection	0 to 2	1	0		732	
	883	G121	Regeneration avoidance operation level	300 to 1200 V	0.1 V	DC380V <sup>*7</sup>		732	
						DC760V <sup>*8</sup>			
	884	G122	Regeneration avoidance at deceleration detection sensitivity	0 to 5	1	0		732	
	885	G123	Regeneration avoidance compensation frequency limit value	0 to 590 Hz, 9999	0.01 Hz	6 Hz		732	
886	G124	Regeneration avoidance voltage gain	0 to 200%	0.1%	100%		732		
—	887 <sup>*9</sup>	C244	Control terminal option—Encoder magnetic pole position offset	0 to 16383, 65535	1	65535		542	
Free parameter	888	E420	Free parameter 1	0 to 9999	1	9999		350	
	889	E421	Free parameter 2	0 to 9999	1	9999		350	
Energy saving monitoring	891	M023	Cumulative power monitor digit shifted times	0 to 4, 9999	1	9999		446, 467	
	892	M200	Load factor	30 to 150%	0.1%	100%		467	
	893	M201	Energy saving monitor reference (motor capacity)	0.1 to 55 kW <sup>*2</sup>	0.01 kW <sup>*2</sup>	Inverter rated capacity		467	
				0 to 3600 kW <sup>*3</sup>	0.1 kW <sup>*3</sup>				
	894	M202	Control selection during commercial power-supply operation	0 to 3	1	0		467	
	895	M203	Power saving rate reference value	0, 1, 9999	1	9999		467	
	896	M204	Power unit cost	0 to 500, 9999	0.01	9999		467	
	897	M205	Power saving monitor average time	0 to 1000 h, 9999	1 h	9999		467	
	898	M206	Power saving cumulative monitor clear	0, 1, 10, 9999	1	9999		467	
899	M207	Operation time rate (estimated value)	0 to 100%, 9999	0.1%	9999		467		

Function	Pr.	Pr. group	Name	Setting range	Minimum setting increments	Initial value		Refer to page	Customer setting
						FM	CA		
Calibration parameter	C0 (900) <sup>*10</sup>	M310	FM/CA terminal calibration	—	—	—		463	
	C1 (901) <sup>*10</sup>	M320	AM terminal calibration	—	—	—		463	
	C2 (902) <sup>*10</sup>	T200	Terminal 2 frequency setting bias frequency	0 to 590 Hz	0.01 Hz	0 Hz		505	
	C3 (902) <sup>*10</sup>	T201	Terminal 2 frequency setting bias	0 to 300%	0.1%	0%		505	
	125 (903) <sup>*10</sup>	T202	Terminal 2 frequency setting gain frequency	0 to 590 Hz	0.01 Hz	60 Hz	50 Hz	505	
	C4 (903) <sup>*10</sup>	T203	Terminal 2 frequency setting gain	0 to 300%	0.1%	100%		505	
	C5 (904) <sup>*10</sup>	T400	Terminal 4 frequency setting bias frequency	0 to 590 Hz	0.01 Hz	0 Hz		505	
	C6 (904) <sup>*10</sup>	T401	Terminal 4 frequency setting bias	0 to 300%	0.1%	20%		505	
	126 (905) <sup>*10</sup>	T402	Terminal 4 frequency setting gain frequency	0 to 590 Hz	0.01 Hz	60 Hz	50 Hz	505	
	C7 (905) <sup>*10</sup>	T403	Terminal 4 frequency setting gain	0 to 300%	0.1%	100%		505	
	C12 (917) <sup>*10</sup>	T100	Terminal 1 bias frequency (speed)	0 to 590 Hz	0.01 Hz	0 Hz		505	
	C13 (917) <sup>*10</sup>	T101	Terminal 1 bias (speed)	0 to 300%	0.1%	0%		505	
	C14 (918) <sup>*10</sup>	T102	Terminal 1 gain frequency (speed)	0 to 590 Hz	0.01 Hz	60 Hz	50 Hz	505	
	C15 (918) <sup>*10</sup>	T103	Terminal 1 gain (speed)	0 to 300%	0.1%	100%		505	
	C16 (919) <sup>*10</sup>	T110	Terminal 1 bias command (torque/magnetic flux)	0 to 400%	0.1%	0%		510	
	C17 (919) <sup>*10</sup>	T111	Terminal 1 bias (torque/magnetic flux)	0 to 300%	0.1%	0%		510	
	C18 (920) <sup>*10</sup>	T112	Terminal 1 gain command (torque/magnetic flux)	0 to 400%	0.1%	150%		510	
	C19 (920) <sup>*10</sup>	T113	Terminal 1 gain (torque/magnetic flux)	0 to 300%	0.1%	100%		510	
	C8 (930) <sup>*10</sup>	M330	Current output bias signal	0 to 100%	0.1%	—	0%	463	
	C9 (930) <sup>*10</sup>	M331	Current output bias current	0 to 100%	0.1%	—	0%	463	
	C10 (931) <sup>*10</sup>	M332	Current output gain signal	0 to 100%	0.1%	—	100%	463	
	C11 (931) <sup>*10</sup>	M333	Current output gain current	0 to 100%	0.1%	—	100%	463	
	C38 (932) <sup>*10</sup>	T410	Terminal 4 bias command (torque/magnetic flux)	0 to 400%	0.1%	0%		510	
	C39 (932) <sup>*10</sup>	T411	Terminal 4 bias (torque/magnetic flux)	0 to 300%	0.1%	20%		510	
	C40 (933) <sup>*10</sup>	T412	Terminal 4 gain command (torque/magnetic flux)	0 to 400%	0.1%	150%		510	
	C41 (933) <sup>*10</sup>	T413	Terminal 4 gain (torque/magnetic flux)	0 to 300%	0.1%	100%		510	

Function	Pr.	Pr. group	Name	Setting range	Minimum setting increments	Initial value		Refer to page	Customer setting
						FM	CA		
PID display	C42 (934) <sup>*10</sup>	A630	PID display bias coefficient	0 to 500, 9999	0.01	9999		615	
	C43 (934) <sup>*10</sup>	A631	PID display bias analog value	0 to 300%	0.1%	20%		615	
	C44 (935) <sup>*10</sup>	A632	PID display gain coefficient	0 to 500, 9999	0.01	9999		615	
	C45 (935) <sup>*10</sup>	A633	PID display gain analog value	0 to 300%	0.1%	100%		615	
—	977	E302	Input voltage mode selection	0 to 2	1	0		345	
—	989	E490	Parameter copy alarm release	10 <sup>*2</sup>	1	10 <sup>*2</sup>		744	
				100 <sup>*3</sup>		100 <sup>*3</sup>			
PU	990	E104	PU buzzer control	0, 1	1	1		340	
	991	E105	PU contrast adjustment	0 to 63	1	58		340	
Monitoring	992	M104	Operation panel setting dial push monitor selection	0 to 3, 5 to 14, 17 to 20, 22 to 36, 38 to 46, 50 to 57, 61, 62, 64, 67, 71 to 75, 87 to 98, 100	1	0		446	
Droop control	994	G403	Droop break point gain	0.1 to 100%, 9999	0.1%	9999		738	
	995	G404	Droop break point torque	0.1 to 100%	0.1%	100%		738	
—	997	H103	Fault initiation	0 to 255, 9999	1	9999		425	
—	998	E430	PM parameter initialization <i>Simple</i>	0, 3003, 3103, 8009, 8109, 9009, 9109	1	0		230	
—	999	E431	Automatic parameter setting <i>Simple</i>	1, 2, 10, 11, 12, 13, 20, 21, 9999	1	9999		350	
—	1000	E108	Direct setting selection	0 to 2	1	0		340	
—	1002	C150	Lq tuning target current adjustment coefficient	50 to 150%, 9999	0.1%	9999		551	
Additional function	1003	G601	Notch filter frequency	0, 8 to 1250 Hz	1 Hz	0		271	
	1004	G602	Notch filter depth	0 to 3	1	0		271	
	1005	G603	Notch filter width	0 to 3	1	0		271	
Clock	1006	E020	Clock (year)	2000 to 2099	1	2000		334	
	1007	E021	Clock (month, day)	Jan. 1 to Dec. 31	1	101		334	
	1008	E022	Clock (hour, minute)	0:00 to 23:59	1	0		334	
—	1015	A607	Integral stop selection at limited frequency	0 to 2, 10 to 12	1	0		601	
—	1016	H021	PTC thermistor protection detection time	0 to 60 s	1 s	0		415	
—	1018	M045	Monitor with sign selection	0, 1, 9999	1	9999		446	

Function	Pr.	Pr. group	Name	Setting range	Minimum setting increments	Initial value		Refer to page	Customer setting
						FM	CA		
Trace	1020	A900	Trace operation selection	0 to 4	1	0		649	
	1021	A901	Trace mode selection	0 to 2	1	0		649	
	1022	A902	Sampling cycle	0 to 9	1	2		649	
	1023	A903	Number of analog channels	1 to 8	1	4		649	
	1024	A904	Sampling auto start	0, 1	1	0		649	
	1025	A905	Trigger mode selection	0 to 4	1	0		649	
	1026	A906	Number of sampling before trigger	0 to 100%	1%	90%		649	
	1027	A910	Analog source selection (1ch)	1 to 3, 5 to 14, 17 to 20, 22 to 24, 32 to 36, 39 to 42, 46, 52 to 54, 61, 62, 64, 67, 71 to 75, 87 to 98, 201 to 213, 222 to 227, 230 to 232, 235 to 238	1	201		649	
	1028	A911	Analog source selection (2ch)			202		649	
	1029	A912	Analog source selection (3ch)			203		649	
	1030	A913	Analog source selection (4ch)			204		649	
	1031	A914	Analog source selection (5ch)			205		649	
	1032	A915	Analog source selection (6ch)			206		649	
	1033	A916	Analog source selection (7ch)			207		649	
	1034	A917	Analog source selection (8ch)			208		649	
	1035	A918	Analog trigger channel	1 to 8	1	1		649	
	1036	A919	Analog trigger operation selection	0, 1	1	0		649	
	1037	A920	Analog trigger level	600 to 1400	1	1000		649	
	1038	A930	Digital source selection (1ch)	1 to 255	1	1		649	
	1039	A931	Digital source selection (2ch)			2		649	
	1040	A932	Digital source selection (3ch)			3		649	
	1041	A933	Digital source selection (4ch)			4		649	
	1042	A934	Digital source selection (5ch)			5		649	
	1043	A935	Digital source selection (6ch)			6		649	
1044	A936	Digital source selection (7ch)	7				649		
1045	A937	Digital source selection (8ch)	8				649		
1046	A938	Digital trigger channel	1 to 8	1	1		649		
1047	A939	Digital trigger operation selection	0, 1	1	0		649		
—	1048	E106	Display-off waiting time	0 to 60 min	1 min	0		340	
—	1049	E110	USB host reset	0, 1	1	0		341	
Anti-sway control	1072	A310	DC brake judgment time for anti-sway control operation	0 to 10 s	0.1 s	3 s		584	
	1073	A311	Anti-sway control operation selection	0, 1	1	0		584	
	1074	A312	Anti-sway control frequency	0.05 to 3 Hz, 9999	0.001 Hz	1 Hz		584	
	1075	A313	Anti-sway control depth	0 to 3	1	0		584	
	1076	A314	Anti-sway control width	0 to 3	1	0		584	
	1077	A315	Rope length	0.1 to 50 m	0.1 m	1 m		584	
	1078	A316	Trolley weight	1 to 50000 kg	1 kg	1 kg		584	
1079	A317	Load weight	1 to 50000 kg	1 kg	1 kg		584		
—	1103	F040	Deceleration time at emergency stop	0 to 3600 s	0.1 s	5 s		367	
—	1105 <sup>99</sup>	C143	Encoder magnetic pole position offset	0 to 16383, 65535	1	65535		542	
Monitoring	1106	M050	Torque monitor filter	0 to 5 s, 9999	0.01 s	9999		446	
	1107	M051	Running speed monitor filter	0 to 5 s, 9999	0.01 s	9999		446	
	1108	M052	Excitation current monitor filter	0 to 5 s, 9999	0.01 s	9999		446	
—	1113	H414	Speed limit method selection	0 to 2, 10, 9999	1	0		287	

Function	Pr.	Pr. group	Name	Setting range	Minimum setting increments	Initial value		Refer to page	Customer setting
						FM	CA		
—	1114	D403	Torque command reverse selection	0, 1	1	1		283	
—	1115	G218	Speed control integral term clear time	0 to 9998 ms	1 ms	0 s		254	
—	1116	G206	Constant output range speed control P gain compensation	0 to 100%	0.1%	0%		254	
—	1117	G261	Speed control P gain 1 (per-unit system)	0 to 300, 9999	0.01	9999		254	
—	1118	G361	Speed control P gain 2 (per-unit system)	0 to 300, 9999	0.01	9999		254	
—	1119	G262	Model speed control gain (per-unit system)	0 to 300, 9999	0.01	9999		263	
—	1121	G260	Per-unit speed control reference frequency	0 to 400 Hz	0.01 Hz.	120 Hz <sup>*2</sup> 60 Hz <sup>*3</sup>		254	
PID control	1134	A605	PID upper limit manipulated value	0 to 100%	0.1%	100%		622	
	1135	A606	PID lower limit manipulated value	0 to 100%	0.1%	100%		622	
	1136	A670	Second PID display bias coefficient	0 to 500, 9999	0.01	9999		615	
	1137	A671	Second PID display bias analog value	0 to 300%	0.1%	20%		615	
	1138	A672	Second PID display gain coefficient	0 to 500, 9999	0.01	9999		615	
	1139	A673	Second PID display gain analog value	0 to 300%	0.1%	100%		615	
	1140	A664	Second PID set point/deviation input selection	1 to 5	1	2		601	
	1141	A665	Second PID measured value input selection	1 to 5	1	3		601	
	1142	A640	Second PID unit selection	0 to 43, 9999	1	9999		601	
	1143	A641	Second PID upper limit	0 to 100%, 9999	0.1%	9999		601	
	1144	A642	Second PID lower limit	0 to 100%, 9999	0.1%	9999		601	
	1145	A643	Second PID deviation limit	0 to 100%, 9999	0.1%	9999		601	
	1146	A644	Second PID signal operation selection	0 to 3, 10 to 13	1	0		601	
	1147	A661	Second output interruption detection time	0 to 3600 s, 9999	0.1 s	1		601	
	1148	A662	Second output interruption detection level	0 to 590 Hz	0.01 Hz	0 Hz		601	
1149	A663	Second output interruption cancel level	900 to 1100%	0.1%	1000%		601		
PLC	1150 to 1199	A810 to A859	PLC function user parameters 1 to 50	0 to 65535	1	0		646	
—	1220	B100	Target position/speed selection	0 to 2	1	0		896	



Function	Pr.	Pr. group	Name	Setting range	Minimum setting increments	Initial value		Refer to page	Customer setting
						FM	CA		
Simple position control	1221	B101	Start command edge detection selection	0, 1	1	0		303	
	1222	B120	First positioning acceleration time	0.01 to 360 s	0.01 s	5 s		303	
	1223	B121	First positioning deceleration time	0.01 to 360 s	0.01 s	5 s		303	
	1224	B122	First positioning dwell time	0 to 20000 ms	1 ms	0 ms		303	
	1225	B123	First positioning sub-function	0 to 2, 10 to 12, 100 to 102, 110 to 112	1	10		303	
	1226	B124	Second positioning acceleration time	0.01 to 360 s	0.01 s	5 s		303	
	1227	B125	Second positioning deceleration time	0.01 to 360 s	0.01 s	5 s		303	
	1228	B126	Second positioning dwell time	0 to 20000 ms	1 ms	0 ms		303	
	1229	B127	Second positioning sub-function	0 to 2, 10 to 12, 100 to 102, 110 to 112	1	10		303	
	1230	B128	Third positioning acceleration time	0.01 to 360 s	0.01 s	5 s		303	
	1231	B129	Third positioning deceleration time	0.01 to 360 s	0.01 s	5 s		303	
	1232	B130	Third positioning dwell time	0 to 20000 ms	1 ms	0 ms		303	
	1233	B131	Third positioning sub-function	0 to 2, 10 to 12, 100 to 102, 110 to 112	1	10		303	
	1234	B132	Fourth positioning acceleration time	0.01 to 360 s	0.01 s	5 s		303	
	1235	B133	Fourth positioning deceleration time	0.01 to 360 s	0.01 s	5 s		303	
	1236	B134	Fourth positioning dwell time	0 to 20000 ms	1 ms	0 ms		303	
	1237	B135	Fourth positioning sub-function	0 to 2, 10 to 12, 100 to 102, 110 to 112	1	10		303	
	1238	B136	Fifth positioning acceleration time	0.01 to 360 s	0.01 s	5 s		303	
	1239	B137	Fifth positioning deceleration time	0.01 to 360 s	0.01 s	5 s		303	
	1240	B138	Fifth positioning dwell time	0 to 20000 ms	1 ms	0 ms		303	
	1241	B139	Fifth positioning sub-function	0 to 2, 10 to 12, 100 to 102, 110 to 112	1	10		303	
	1242	B140	Sixth positioning acceleration time	0.01 to 360 s	0.01 s	5 s		303	
	1243	B141	Sixth positioning deceleration time	0.01 to 360 s	0.01 s	5 s		303	
	1244	B142	Sixth positioning dwell time	0 to 20000 ms	1 ms	0 ms		303	
1245	B143	Sixth positioning sub-function	0 to 2, 10 to 12, 100 to 102, 110 to 112	1	10		303		
1246	B144	Seventh positioning acceleration time	0.01 to 360 s	0.01 s	5 s		303		
1247	B145	Seventh positioning deceleration time	0.01 to 360 s	0.01 s	5 s		303		
1248	B146	Seventh positioning dwell time	0 to 20000 ms	1 ms	0 ms		303		
1249	B147	Seventh positioning sub-function	0 to 2, 10 to 12, 100 to 102, 110 to 112	1	10		303		

Function	Pr.	Pr. group	Name	Setting range	Minimum setting increments	Initial value		Refer to page	Customer setting
						FM	CA		
Simple position control	1250	B148	Eighth positioning acceleration time	0.01 to 360 s	0.01 s	5 s		303	
	1251	B149	Eighth positioning deceleration time	0.01 to 360 s	0.01 s	5 s		303	
	1252	B150	Eighth positioning dwell time	0 to 20000 ms	1 ms	0 ms		303	
	1253	B151	Eighth positioning sub-function	0 to 2, 10 to 12, 100 to 102, 110 to 112	1	10		303	
	1254	B152	Ninth positioning acceleration time	0.01 to 360 s	0.01 s	5 s		303	
	1255	B153	Ninth positioning deceleration time	0.01 to 360 s	0.01 s	5 s		303	
	1256	B154	Ninth positioning dwell time	0 to 20000 ms	1 ms	0 ms		303	
	1257	B155	Ninth positioning sub-function	0 to 2, 10 to 12, 100 to 102, 110 to 112	1	10		303	
	1258	B156	Tenth positioning acceleration time	0.01 to 360 s	0.01 s	5 s		303	
	1259	B157	Tenth positioning deceleration time	0.01 to 360 s	0.01 s	5 s		303	
	1260	B158	Tenth positioning dwell time	0 to 20000 ms	1 ms	0 ms		303	
	1261	B159	Tenth positioning sub-function	0 to 2, 10 to 12, 100 to 102, 110 to 112	1	10		303	
	1262	B160	Eleventh positioning acceleration time	0.01 to 360 s	0.01 s	5 s		303	
	1263	B161	Eleventh positioning deceleration time	0.01 to 360 s	0.01 s	5 s		303	
	1264	B162	Eleventh positioning dwell time	0 to 20000 ms	1 ms	0 ms		303	
	1265	B163	Eleventh positioning sub-function	0 to 2, 10 to 12, 100 to 102, 110 to 112	1	10		303	
	1266	B164	Twelfth positioning acceleration time	0.01 to 360 s	0.01 s	5 s		303	
	1267	B165	Twelfth positioning deceleration time	0.01 to 360 s	0.01 s	5 s		303	
	1268	B166	Twelfth positioning dwell time	0 to 20000 ms	1 ms	0 ms		303	
	1269	B167	Twelfth positioning sub-function	0 to 2, 10 to 12, 100 to 102, 110 to 112	1	10		303	
	1270	B168	Thirteenth positioning acceleration time	0.01 to 360 s	0.01 s	5 s		303	
	1271	B169	Thirteenth positioning deceleration time	0.01 to 360 s	0.01 s	5 s		303	
	1272	B170	Thirteenth positioning dwell time	0 to 20000 ms	1 ms	0 ms		303	
	1273	B171	Thirteenth positioning sub-function	0 to 2, 10 to 12, 100 to 102, 110 to 112	1	10		303	
	1274	B172	Fourteenth positioning acceleration time	0.01 to 360 s	0.01 s	5 s		303	
	1275	B173	Fourteenth positioning deceleration time	0.01 to 360 s	0.01 s	5 s		303	
	1276	B174	Fourteenth positioning dwell time	0 to 20000 ms	1 ms	0 ms		303	
	1277	B175	Fourteenth positioning sub-function	0 to 2, 10 to 12, 100 to 102, 110 to 112	1	10		303	
1278	B176	Fifteenth positioning acceleration time	0.01 to 360 s	0.01 s	5 s		303		
1279	B177	Fifteenth positioning deceleration time	0.01 to 360 s	0.01 s	5 s		303		
1280	B178	Fifteenth positioning dwell time	0 to 20000 ms	1 ms	0 ms		303		
1281	B179	Fifteenth positioning sub-function	0, 2, 10, 12, 100, 102, 110, 112	1	10		303		

Function	Pr.	Pr. group	Name	Setting range	Minimum setting increments	Initial value		Refer to page	Customer setting
						FM	CA		
Home position return / position detection	1282	B180	Home position return method selection	0 to 6	1	4		303	
	1283	B181	Home position return speed	0 to 30 Hz	0.01 Hz.	2 Hz		303	
	1284	B182	Home position return shifting speed	0 to 10 Hz	0.01 Hz.	0.5 Hz		303	
	1285	B183	Home position shift amount lower 4 digits	0 to 9999	1	0		303	
	1286	B184	Home position shift amount upper 4 digits	0 to 9999	1	0		303	
	1287	B185	Travel distance after proximity dog ON lower 4 digits	0 to 9999	1	2048		303	
	1288	B186	Travel distance after proximity dog ON upper 4 digits	0 to 9999	1	0		303	
	1289	B187	Home position return stopper torque	0 to 200%	0.1%	40%		303	
	1290	B188	Home position return stopper waiting time	0 to 10 s	0.1 s	0.5 s		303	
	1292	B190	Position control terminal input selection	0, 1	1	0		303	
	1293	B191	Roll feeding mode selection	0, 1	1	0		303	
	1294	B192	Position detection lower 4 digits	0 to 9999	1	0		327	
	1295	B193	Position detection upper 4 digits	0 to 9999	1	0		327	
	1296	B194	Position detection selection	0 to 2	1	0		327	
	1297	B195	Position detection hysteresis width	0 to 32767	1	0		327	
—	1298	B013	Second position control gain	0 to 150 s <sup>-1</sup>	1 s <sup>-1</sup>	25 s <sup>-1</sup>		328	
—	1299	G108	Second pre-excitation selection	0, 1	1	0		715	
—	1300 to 1343	N500 to N543	Communication option parameters. For details, refer to the Instruction Manual of the option.						
—	1348	G263	P/PI control switchover frequency	0 to 400 Hz	0.01 Hz.	0 Hz		254	
—	1349	G264	Emergency stop operation selection	0, 1, 10, 11	1	0		367	
—	1350 to 1359	N550 to N559	Communication option parameters. For details, refer to the Instruction Manual of the option.						
—	1410	A170	Starting times lower 4 digits	0 to 9999	1	0		576	
—	1411	A171	Starting times upper 4 digits	0 to 9999	1	0		576	
—	1412	C135	Motor induced voltage constant (phi f) exponent	0 to 2, 9999	1	9999		551	
—	1413	C235	Second motor induced voltage constant (phi f) exponent	0 to 2, 9999	1	9999		551	

Function	Pr.	Pr. group	Name	Setting range	Minimum setting increments	Initial value		Refer to page	Customer setting
						FM	CA		
Load characteristics fault detection	1480	H520	Load characteristics measurement mode	0, 1 (2 to 5, 81 to 85)	1	0		439	
	1481	H521	Load characteristics load reference 1	0 to 400%, 8888, 9999	0.1%	9999		439	
	1482	H522	Load characteristics load reference 2	0 to 400%, 8888, 9999	0.1%	9999		439	
	1483	H523	Load characteristics load reference 3	0 to 400%, 8888, 9999	0.1%	9999		439	
	1484	H524	Load characteristics load reference 4	0 to 400%, 8888, 9999	0.1%	9999		439	
	1485	H525	Load characteristics load reference 5	0 to 400%, 8888, 9999	0.1%	9999		439	
	1486	H526	Load characteristics maximum frequency	0 to 590 Hz	0.01 Hz	60 Hz	50 Hz	439	
	1487	H527	Load characteristics minimum frequency	0 to 590 Hz	0.01 Hz	6 Hz		439	
	1488	H531	Upper limit warning detection width	0 to 400%, 9999	0.1%	20%		439	
	1489	H532	Lower limit warning detection width	0 to 400%, 9999	0.1%	20%		439	
	1490	H533	Upper limit fault detection width	0 to 400%, 9999	0.1%	9999		439	
	1491	H534	Lower limit fault detection width	0 to 400%, 9999	0.1%	9999		439	
	1492	H535	Load status detection signal delay time / load reference measurement waiting time	0 to 60 s	0.1 s	1 s		439	
—	1499	E415	Parameter for manufacturer setting. Do not set.						
Clear parameters	Pr.CLR		Parameter clear	(0), 1	1	0		743	
	ALL.CL		All parameter clear	(0), 1	1	0		743	
	Err.CL		Fault history clear	(0), 1	1	0		774	
—	Pr.CPY		Parameter copy	(0), 1 to 3	1	0		744	
—	Pr.CHG		Initial value change list	—	1	0		751	
—	IPM		IPM initialization	0, 3003	1	0		230	
—	AUTO		Automatic parameter setting	—	—	—		350	
—	Pr.MD		Group parameter setting	(0), 1, 2	1	0		201	

\*1 Differs according to the capacity.

6%: FR-A820-00077(0.75K) or lower, FR-A840-00038(0.75K) or lower

4%: FR-A820-00105(1.5K) to FR-A820-00250(3.7K), FR-A840-00052(1.5K) to FR-A840-00126(3.7K)

3%: FR-A820-00340(5.5K), FR-A820-00490(7.5K), FR-A840-00170(5.5K), FR-A840-00250(7.5K)

2%: FR-A820-00630(11K) to FR-A820-03160(55K), FR-A840-00310(11K) to FR-A840-01800(55K)

1%: FR-A820-03800(75K) or higher, FR-A840-02160(75K) or higher

\*2 The setting range or initial value for the FR-A820-03160(55K) or lower and FR-A840-01800(55K) or lower.

\*3 The setting range or initial value for the FR-A820-03800(75K) or higher and FR-A840-02160(75K) or higher.

\*4 The initial value for the FR-A820-00490(7.5K) or lower and FR-A840-00250(7.5K) or lower.

\*5 The initial value for the FR-A820-00630(11K) or higher and FR-A840-00310(11K) or higher.

\*6 Differs according to the capacity.

4%: FR-A820-00490(7.5K) or lower, FR-A840-00250(7.5K) or lower

2%: FR-A820-00630(11K) to FR-A820-03160(55K), FR-A840-00310(11K) to FR-A840-01800(55K)

1%: FR-A820-03800(75K) or higher, FR-A840-02160(75K) or higher

\*7 The value for the 200 V class.

\*8 The value for the 400 V class.

\*9 The setting is available only when a plug-in option that supports Vector control is installed. For the corresponding parameters of each option, refer to the detail page.

\*10 The parameter number in parentheses is that used (displayed) on the LCD operation panel and the parameter unit.

\*11 The setting range or initial value for the standard model.

\*12 The setting range or initial value for the separated converter type.

\*13 The setting range or initial value for the IP55 compatible model.

\*14 The setting is available for the standard structure model.

\*15 The setting is available for the standard structure model and the IP55 compatible model.

\*16 The setting is available when the PLC function is enabled.

- \*17 The setting is available for the FR-A800-GF or when a compatible plug-in option is installed.
- \*18 Refer to the FR-A8AVP Instruction Manual (For Inverter/Converter Switching).





## 5.1.2 Use of a function group number for the identification of parameters

A parameter identification number shown on the PU can be switched from a parameter number to a function group number. As parameters are grouped by function and displayed by the group, the related parameters can be set continually at a time.

### ◆ Changing a parameter identification number to a function group number

Pr.MD setting	Description
0	The setting of parameter identification number remains the same as the last setting.
1	The parameter number is used for the identification of parameters, and displayed in numerical order.
2	The function group number is used for the identification of parameters, and displayed in alphanumeric order.









#### Operating procedure

- 1.** Turning ON the power of the inverter  
The operation panel is in the monitor mode.
- 2.** Selecting the parameter setting mode  
Press  to choose the parameter setting mode. (The parameter number read previously appears on the 12-segment LCD display.)
- 3.** Selecting a parameter  
Turn  until "Pr.Md" (Group parameter setting) appears.  
Press  to confirm the selection. The setting "0" (initial value) will appear.
- 4.** Selecting the use of the function group number  
Turn  to change the set value to "2" (function group number). Press  to confirm the Group parameter setting. "2" and "Pr.Md" are displayed alternately after the setting is completed.

## ◆ Selecting a parameter by function group number to change its setting

The following shows the procedure to change the setting of **P.H400 (Pr.1) Maximum frequency**.

### Operating procedure

1. Turning ON the power of the inverter  
The operation panel is in the monitor mode.
2. Changing the operation mode  
Press  to choose the PU operation mode. [PU] indicator turns ON.
3. Selecting the parameter setting mode  
Press  to choose the parameter setting mode. (The parameter number read previously appears on the 12-segment LCD display.)
4. Enabling the function group selection  
Press  several times until "P.F0 . ." appears. Parameter groups can now be selected.
5. Enabling the function group selection  
Turn  until "P.H4 . ." (Protective function parameter 4) appears. Press  to confirm the selection. "P.H4-- --" will appear, which shows that the operation panel is ready for selection of a number in the group of Protective function parameter 4.
6. Selecting a parameter  
Turn  until "P.H400" (P.H400 Maximum frequency) appears. Press  to display the present set value. "12000 (initial value)" appears.
7. Changing the setting value  
Turn  to change the set value to "6000". Press  to confirm the selection. "6000" and "P.H400" are displayed alternately after the setting is completed.

## 5.1.3 Parameter list (by function group number)

### ◆ E: Environment setting parameters

Parameters for the inverter operating environment.

Pr. group	Pr.	Name	Refer to page
E000	168	Parameter for manufacturer setting. Do not set.	
E001	169	Parameter for manufacturer setting. Do not set.	
E020	1006	Clock (year)	334
E021	1007	Clock (month, day)	334
E022	1008	Clock (hour, minute)	334
E023	269	Parameter for manufacturer setting. Do not set.	
E080	168	Parameter for manufacturer setting. Do not set.	
E081	169	Parameter for manufacturer setting. Do not set.	
E100	75	Reset selection	336
E101	75	Disconnected PU detection	336
E102	75	PU stop selection	336
E103	145	PU display language selection	339
E104	990	PU buzzer control	340
E105	991	PU contrast adjustment	340
E106	1048	Display-off waiting time	340
E107	75	Reset limit	336
E108	1000	Direct setting selection	340
E110	1049	USB host reset	341
E200	161	Frequency setting/key lock operation selection	341
E201	295	Frequency change increment amount setting	342
E300	30	Regenerative function selection	724
E301	570	Multiple rating setting	343
E302	977	Input voltage mode selection	345
E310	328	Inverter/converter switching <i>Simple</i>	*7
E400	77	Parameter write selection	345
E410	296	Password lock level	348
E411	297	Password lock/unlock	348
E415	1499	Parameter for manufacturer setting. Do not set.	
E420	888	Free parameter 1	350
E421	889	Free parameter 2	350
E430	998	PM parameter initialization <i>Simple</i>	230
E431	999	Automatic parameter setting <i>Simple</i>	350
E440	160	User group read selection <i>Simple</i>	354
E441	172	User group registered display/batch clear	354
E442	173	User group registration	354
E443	174	User group clear	354
E490	989	Parameter copy alarm release	744
E600	72	PWM frequency selection	356
E601	240	Soft-PWM operation selection	356

Pr. group	Pr.	Name	Refer to page
E602	260	PWM frequency automatic switchover	356
E700	255	Life alarm status display	359
E701	256 <sup>*4</sup>	Inrush current limit circuit life display	359
E702	257	Control circuit capacitor life display	359
E703	258 <sup>*4</sup>	Main circuit capacitor life display	359
E704	259 <sup>*4</sup>	Main circuit capacitor life measuring	359
E706	507	Display/reset ABC1 relay contact life	359
E707	508	Display/reset ABC2 relay contact life	359
E710	503	Maintenance timer 1	363
E711	504	Maintenance timer 1 warning output set time	363
E712	686	Maintenance timer 2	363
E713	687	Maintenance timer 2 warning output set time	363
E714	688	Maintenance timer 3	363
E715	689	Maintenance timer 3 warning output set time	363
E720	555	Current average time	363
E721	556	Data output mask time	363
E722	557	Current average value monitor signal output reference current	363

5

### ◆ F: Parameters for the settings of the acceleration/deceleration time and the acceleration/deceleration pattern

Parameters for the motor acceleration/deceleration characteristics.

Pr. group	Pr.	Name	Refer to page
F000	20	Acceleration/deceleration reference frequency	367
F001	21	Acceleration/deceleration time increments	367
F002	16	Jog acceleration/deceleration time	410
F003	611	Acceleration time at a restart	628, 635
F010	7	Acceleration time <i>Simple</i>	367
F011	8	Deceleration time <i>Simple</i>	367
F020	44	Second acceleration/deceleration time	367, 622
F021	45	Second deceleration time	367, 622
F022	147	Acceleration/deceleration time switching frequency	367
F030	110	Third acceleration/deceleration time	367
F031	111	Third deceleration time	367



Pr. group	Pr.	Name	Refer to page
F040	1103	Deceleration time at emergency stop	367
F070	791	Acceleration time in low-speed range	367
F071	792	Deceleration time in low-speed range	367
F100	29	Acceleration/deceleration pattern selection	372
F101	59	Remote function selection	377
F102	13	Starting frequency	381, 382
F103	571	Holding time at a start	381
F200	140	Backlash acceleration stopping frequency	372
F201	141	Backlash acceleration stopping time	372
F202	142	Backlash deceleration stopping frequency	372
F203	143	Backlash deceleration stopping time	372
F300	380	Acceleration S-pattern 1	372
F301	381	Deceleration S-pattern 1	372
F302	382	Acceleration S-pattern 2	372
F303	383	Deceleration S-pattern 2	372
F400	516	S-pattern time at a start of acceleration	372
F401	517	S-pattern time at a completion of acceleration	372
F402	518	S-pattern time at a start of deceleration	372
F403	519	S-pattern time at a completion of deceleration	372
F500	292	Automatic acceleration/ deceleration	384, 387, 572
F510	61	Reference current	384, 387
F511	62	Reference value at acceleration	384
F512	63	Reference value at deceleration	384
F513	293	Acceleration/deceleration separate selection	384
F520	64	Starting frequency for elevator mode	387

## ◆ D: Parameters for the setting of operation command and frequency command

Parameters for setting the command source to the inverter, and the motor driving frequency and torque.

Pr. group	Pr.	Name	Refer to page
D000	79	Operation mode selection <i>Simple</i>	389, 398
D001	340	Communication startup mode selection	398
D010	338	Communication operation command source	400

Pr. group	Pr.	Name	Refer to page
D011	339	Communication speed command source	400
D012	550	NET mode operation command source selection	400
D013	551	PU mode operation command source selection	400
D020	78	Reverse rotation prevention selection	406
D030	811	Set resolution switchover	245, 444
D100	291	Pulse train I/O selection	406, 457
D101	384	Input pulse division scaling factor	406
D110	385	Frequency for zero input pulse	406
D111	386	Frequency for maximum input pulse	406
D120	432 <sup>*1</sup>	Pulse train torque command bias	283
D121	433 <sup>*1</sup>	Pulse train torque command gain	283
D200	15	Jog frequency	410
D300	28	Multi-speed input compensation selection	411
D301	4	Multi-speed setting (high speed) <i>Simple</i>	411
D302	5	Multi-speed setting (middle speed) <i>Simple</i>	411
D303	6	Multi-speed setting (low speed) <i>Simple</i>	411
D304 to D307	24 to 27	Multi-speed setting (speed 4 to speed 7)	411
D308 to D315	232 to 239	Multi-speed setting (speed 8 to speed 15)	411
D400	804	Torque command source selection	283
D401	805	Torque command value (RAM)	283
D402	806	Torque command value (RAM, EEPROM)	283
D403	1114	Torque command reverse selection	283

## ◆ H: Protective function parameter

Parameters to protect the motor and the inverter.

Pr. group	Pr.	Name	Refer to page
H000	9	Electronic thermal O/L relay <i>Simple</i>	415, 532, 551
H001	600	First free thermal reduction frequency 1	415
H002	601	First free thermal reduction ratio 1	415
H003	602	First free thermal reduction frequency 2	415
H004	603	First free thermal reduction ratio 2	415
H005	604	First free thermal reduction frequency 3	415
H006	607	Motor permissible load level	415

Pr. group	Pr.	Name	Refer to page
H010	51	Second electronic thermal O/L relay	415, 532, 551
H011	692	Second free thermal reduction frequency 1	415
H012	693	Second free thermal reduction ratio 1	415
H013	694	Second free thermal reduction frequency 2	415
H014	695	Second free thermal reduction ratio 2	415
H015	696	Second free thermal reduction frequency 3	415
H016	608	Second motor permissible load level	415
H020	561	PTC thermistor protection level	415
H021	1016	PTC thermistor protection detection time	415
H022	876 <sup>*1</sup>	Thermal protector input	415
H030	875	Fault definition	422
H100	244	Cooling fan operation selection	423
H101	249	Earth (ground) fault detection at start	425
H102	598	Undervoltage level	425
H103	997	Fault initiation	425
H106	244	Cooling fan operation selection during the test operation	423
H200	251	Output phase loss protection selection	426
H201	872 <sup>*4</sup>	Input phase loss protection selection	426
H300	65	Retry selection	426
H301	67	Number of retries at fault occurrence	426
H302	68	Retry waiting time	426
H303	69	Retry count display erase	426
H400	1	Maximum frequency <i>Simple</i>	428
H401	2	Minimum frequency <i>Simple</i>	428
H402	18	High speed maximum frequency	428
H410	807	Speed limit selection	287
H411	808	Forward rotation speed limit/ speed limit	287
H412	809	Reverse rotation speed limit/ reverse-side speed limit	287
H414	1113	Speed limit method selection	287
H415	873 <sup>*1</sup>	Speed limit	269
H416	285	Speed deviation excess detection frequency	269, 736
H417	853 <sup>*1</sup>	Speed deviation time	269
H420	31	Frequency jump 1A	429
H421	32	Frequency jump 1B	429
H422	33	Frequency jump 2A	429
H423	34	Frequency jump 2B	429
H424	35	Frequency jump 3A	429
H425	36	Frequency jump 3B	429
H429	552	Frequency jump range	429

Pr. group	Pr.	Name	Refer to page
H500	22	Stall prevention operation level (Torque limit level)	245, 431
H501	156	Stall prevention operation selection	431
H520	1480	Load characteristics measurement mode	439
H521	1481	Load characteristics load reference 1	439
H522	1482	Load characteristics load reference 2	439
H523	1483	Load characteristics load reference 3	439
H524	1484	Load characteristics load reference 4	439
H525	1485	Load characteristics load reference 5	439
H526	1486	Load characteristics maximum frequency	439
H527	1487	Load characteristics minimum frequency	439
H531	1488	Upper limit warning detection width	439
H532	1489	Lower limit warning detection width	439
H533	1490	Upper limit fault detection width	439
H534	1491	Lower limit fault detection width	439
H535	1492	Load status detection signal delay time / load reference measurement waiting time	439
H600	48	Second stall prevention operation level	431
H601	49	Second stall prevention operation frequency	431
H602	114	Third stall prevention operation level	431
H603	115	Third stall prevention operation frequency	431
H610	23	Stall prevention operation level compensation factor at double speed	431
H611	66	Stall prevention operation reduction starting frequency	431
H620	148	Stall prevention level at 0 V input	431
H621	149	Stall prevention level at 10 V input	431
H631	154	Voltage reduction selection during stall prevention operation	431
H700	810	Torque limit input method selection	245
H701	812	Torque limit level (regeneration)	245
H702	813	Torque limit level (3rd quadrant)	245
H703	814	Torque limit level (4th quadrant)	245
H704	801	Output limit level	245, 283
H710	815	Torque limit level 2	245
H720	816	Torque limit level during acceleration	245

Pr. group	Pr.	Name	Refer to page
H721	817	Torque limit level during deceleration	245
H730	874	OLT level setting	245
H800	374	Overspeed detection level	443
H881	690	Deceleration check time	270

## ◆ M: Monitoring and its output signal

Parameters for the settings regarding the monitoring to check the inverter's operating status and the output signals for the monitoring.

Pr. group	Pr.	Name	Refer to page
M000	37	Speed display	444
M001	505	Speed setting reference	444
M002	144	Speed setting switchover	444
M020	170	Watt-hour meter clear	446
M021	563	Energization time carrying-over times	446
M022	268	Monitor decimal digits selection	446
M023	891	Cumulative power monitor digit shifted times	446, 467
M030	171	Operation hour meter clear	446
M031	564	Operating time carrying-over times	446
M040	55	Frequency monitoring reference	457
M041	56	Current monitoring reference	457
M042	866	Torque monitoring reference	457
M043	241	Analog input display unit switchover	505
M044	290	Monitor negative output selection	446, 457
M045	1018	Monitor with sign selection	446
M050	1106	Torque monitor filter	446
M051	1107	Running speed monitor filter	446
M052	1108	Excitation current monitor filter	446
M060	663	Control circuit temperature signal output level	494
M100	52	Operation panel main monitor selection	446
M101	774	Operation panel monitor selection 1	446
M102	775	Operation panel monitor selection 2	446
M103	776	Operation panel monitor selection 3	446
M104	992	Operation panel setting dial push monitor selection	457, 446
M200	892	Load factor	467
M201	893	Energy saving monitor reference (motor capacity)	467
M202	894	Control selection during commercial power-supply operation	467
M203	895	Power saving rate reference value	467
M204	896	Power unit cost	467

Pr. group	Pr.	Name	Refer to page
M205	897	Power saving monitor average time	467
M206	898	Power saving cumulative monitor clear	467
M207	899	Operation time rate (estimated value)	467
M300	54	FM/CA terminal function selection	457
M301	158	AM terminal function selection	457
M310	C0 (900) <sup>*2</sup>	FM/CA terminal calibration	463
M320	C1 (901) <sup>*2</sup>	AM terminal calibration	463
M321	867	AM output filter	463
M330	C8 (930) <sup>*2</sup>	Current output bias signal	463
M331	C9 (930) <sup>*2</sup>	Current output bias current	463
M332	C10 (931) <sup>*2</sup>	Current output gain signal	463
M333	C11 (931) <sup>*2</sup>	Current output gain current	463
M334	869	Current output filter	463
M400	190	RUN terminal function selection	473
M401	191	SU terminal function selection	473
M402	192	IPF terminal function selection	473
M403	193	OL terminal function selection	473
M404	194	FU terminal function selection	473
M405	195	ABC1 terminal function selection	473
M406	196	ABC2 terminal function selection	473
M410	313 <sup>*5*6</sup>	DO0 output selection	473
M411	314 <sup>*5*6</sup>	DO1 output selection	473
M412	315 <sup>*5*6</sup>	DO2 output selection	473
M413	316 <sup>*5</sup>	DO3 output selection	473
M414	317 <sup>*5</sup>	DO4 output selection	473
M415	318 <sup>*5</sup>	DO5 output selection	473
M416	319 <sup>*5</sup>	DO6 output selection	473
M420	320 <sup>*5</sup>	RA1 output selection	473
M421	321 <sup>*5</sup>	RA2 output selection	473
M422	322 <sup>*5</sup>	RA3 output selection	473
M430	157	OL signal output timer	245, 431
M431	289	Inverter output terminal filter	473
M433	166	Output current detection signal retention time	487
M440	870	Speed detection hysteresis	484
M441	41	Up-to-frequency sensitivity	484
M442	42	Output frequency detection	484
M443	43	Output frequency detection for reverse rotation	484
M444	50	Second output frequency detection	484
M445	116	Third output frequency detection	488, 484
M446	865	Low speed detection	484
M460	150	Output current detection level	487

Pr. group	Pr.	Name	Refer to page
M461	151	Output current detection signal delay time	487
M462	152	Zero current detection level	487
M463	153	Zero current detection time	487
M464	167	Output current detection operation selection	487
M470	864	Torque detection	488
M500	495	Remote output selection	489
M501	496	Remote output data 1	489
M502	497	Remote output data 2	489
M510	76	Fault code output selection	492
M520	799	Pulse increment setting for output power	493
M530	655	Analog remote output selection	490
M531	656	Analog remote output 1	490
M532	657	Analog remote output 2	490
M533	658	Analog remote output 3	490
M534	659	Analog remote output 4	490
M600	863 <sup>*1</sup>	Control terminal option-Encoder pulse division ratio	495
M601	413 <sup>*1</sup>	Encoder pulse division ratio	495
M610	635 <sup>*1</sup>	Cumulative pulse clear signal selection	321
M611	636 <sup>*1</sup>	Cumulative pulse division scaling factor	321
M612	637 <sup>*1</sup>	Control terminal option-Cumulative pulse division scaling factor	321
M613	638 <sup>*1</sup>	Cumulative pulse storage	321

## ◆ T: Multi-function input terminal parameters

Parameters for the setting of the input terminals via which commands are given to the inverter.

Pr. group	Pr.	Name	Refer to page
T000	73	Analog input selection	496, 501
T001	267	Terminal 4 input selection	496
T002	74	Input filter time constant	503
T003	822	Speed setting filter 1	503
T004	826	Torque setting filter 1	503
T005	832	Speed setting filter 2	503
T006	836	Torque setting filter 2	503
T007	849	Analog input offset adjustment	503
T010	868	Terminal 1 function assignment	245, 431, 500
T021	242	Terminal 1 added compensation amount (terminal 2)	501
T022	125	Terminal 2 frequency setting gain frequency <i>Simple</i>	505
T040	858	Terminal 4 function assignment	245, 431, 500
T041	243	Terminal 1 added compensation amount (terminal 4)	501

Pr. group	Pr.	Name	Refer to page
T042	126	Terminal 4 frequency setting gain frequency <i>Simple</i>	505
T050	252	Override bias	501
T051	253	Override gain	501
T052	573	4 mA input check selection	517
T053	777	4 mA input fault operation frequency	517
T054	778	4 mA input check filter	517
T100	C12 (917) <sup>*2</sup>	Terminal 1 bias frequency (speed)	505
T101	C13 (917) <sup>*2</sup>	Terminal 1 bias (speed)	505
T102	C14 (918) <sup>*2</sup>	Terminal 1 gain frequency (speed)	505
T103	C15 (918) <sup>*2</sup>	Terminal 1 gain (speed)	505
T110	C16 (919) <sup>*2</sup>	Terminal 1 bias command (torque/magnetic flux)	510
T111	C17 (919) <sup>*2</sup>	Terminal 1 bias (torque/magnetic flux)	510
T112	C18 (920) <sup>*2</sup>	Terminal 1 gain command (torque/magnetic flux)	510
T113	C19 (920) <sup>*2</sup>	Terminal 1 gain (torque/magnetic flux)	510
T200	C2 (902) <sup>*2</sup>	Terminal 2 frequency setting bias frequency	505
T201	C3 (902) <sup>*2</sup>	Terminal 2 frequency setting bias	505
T202	125 (903) <sup>*2</sup>	Terminal 2 frequency setting gain frequency	505
T203	C4 (903) <sup>*2</sup>	Terminal 2 frequency setting gain	505
T400	C5 (904) <sup>*2</sup>	Terminal 4 frequency setting bias frequency	505
T401	C6 (904) <sup>*2</sup>	Terminal 4 frequency setting bias	505
T402	126 (905) <sup>*2</sup>	Terminal 4 frequency setting gain frequency	505
T403	C7 (905) <sup>*2</sup>	Terminal 4 frequency setting gain	505
T410	C38 (932) <sup>*2</sup>	Terminal 4 bias command (torque/magnetic flux)	510
T411	C39 (932) <sup>*2</sup>	Terminal 4 bias (torque/magnetic flux)	510
T412	C40 (933) <sup>*2</sup>	Terminal 4 gain command (torque/magnetic flux)	510
T413	C41 (933) <sup>*2</sup>	Terminal 4 gain (torque/magnetic flux)	510
T700	178	STF terminal function selection	521
T701	179	STR terminal function selection	521
T702	180	RL terminal function selection	521
T703	181	RM terminal function selection	521
T704	182	RH terminal function selection	521
T705	183	RT terminal function selection	521
T706	184	AU terminal function selection	521
T707	185	JOG terminal function selection	521

Pr. group	Pr.	Name	Refer to page
T708	186	CS terminal function selection	521
T709	187	MRS terminal function selection	521
T710	188	STOP terminal function selection	521
T711	189	RES terminal function selection	521
T720	17	MRS input selection	524
T721	599	X10 terminal input selection	724
T722	606	Power failure stop external signal input selection	642
T730	155	RT signal function validity condition selection	525
T740	699	Input terminal filter	521

## ◆ C: Motor constant parameters

Parameters for the applied motor setting.

Pr. group	Pr.	Name	Refer to page
C000	684	Tuning data unit switchover	532, 551
C100	71	Applied motor	528, 532
C101	80	Motor capacity	221, 532, 551
C102	81	Number of motor poles	221, 532, 551
C103	9	Rated motor current <i>Simple</i>	415, 532, 551
C104	83	Rated motor voltage	221, 532, 551
C105	84	Rated motor frequency	221, 532, 551
C106	702	Maximum motor frequency	551
C107	707	Motor inertia (integer)	551
C108	724	Motor inertia (exponent)	551
C110	96	Auto tuning setting/status	532, 551, 638
C111	95	Online auto tuning selection	558
C112	818	Easy gain tuning response level setting	254
C113	819	Easy gain tuning selection	254
C114	880	Load inertia ratio	254, 263
C120	90	Motor constant (R1)	532, 551, 638
C121	91	Motor constant (R2)	532
C122	92	Motor constant (L1)/d-axis inductance (Ld)	532, 551
C123	93	Motor constant (L2)/q-axis inductance (Lq)	532, 551
C124	94	Motor constant (X)	532
C125	82	Motor excitation current	532
C126	859	Torque current/Rated PM motor current	532, 551

Pr. group	Pr.	Name	Refer to page
C130	706	Induced voltage constant (phi f)	551
C131	711	Motor Ld decay ratio	551
C132	712	Motor Lq decay ratio	551
C133	725	Motor protection current level	551
C135	1412	Motor induced voltage constant (phi f) exponent	551
C140	369*1	Number of encoder pulses	94, 585, 736
C141	359*1	Encoder rotation direction	94, 585, 736
C142	373*1	Encoder position tuning setting/status	542
C143	1105*1	Encoder magnetic pole position offset	542
C148	376*1	Encoder signal loss detection enable/disable selection	561
C150	1002	Lq tuning target current adjustment coefficient	551
C182	717	Starting resistance tuning compensation	551
C185	721	Starting magnetic pole position detection pulse width	551
C200	450	Second applied motor	528
C201	453	Second motor capacity	532, 551
C202	454	Number of second motor poles	532, 551
C203	51	Rated second motor current	415, 532, 551
C204	456	Rated second motor voltage	532, 551
C205	457	Rated second motor frequency	532, 551
C206	743	Second motor maximum frequency	551
C207	744	Second motor inertia (integer)	551
C208	745	Second motor inertia (exponent)	551
C210	463	Second motor auto tuning setting/status	532, 551, 638
C211	574	Second motor online auto tuning	558
C220	458	Second motor constant (R1)	532, 551, 638
C221	459	Second motor constant (R2)	532
C222	460	Second motor constant (L1) / d-axis inductance (Ld)	532, 551
C223	461	Second motor constant (L2) / q-axis inductance (Lq)	532, 551
C224	462	Second motor constant (X)	532
C225	455	Second motor excitation current	532
C226	860	Second motor torque current/ Rated PM motor current	532, 551
C230	738	Second motor induced voltage constant (phi f)	551
C231	739	Second motor Ld decay ratio	551
C232	740	Second motor Lq decay ratio	551



Pr. group	Pr.	Name	Refer to page
C233	746	Second motor protection current level	551
C235	1413	Second motor induced voltage constant (phi f) exponent	551
C240	851 <sup>*1</sup>	Control terminal option—Number of encoder pulses	94
C241	852 <sup>*1</sup>	Control terminal option—Encoder rotation direction	94
C242	862 <sup>*1</sup>	Encoder option selection	226
C243	871 <sup>*1</sup>	Control terminal option—Encoder position tuning setting/status	542
C244	887 <sup>*1</sup>	Control terminal option—Encoder magnetic pole position offset	542
C248	855 <sup>*1</sup>	Control terminal option—Signal loss detection enable/disable selection	561
C282	741	Second starting resistance tuning compensation	551
C285	742	Second motor magnetic pole detection pulse width	551

## ◆ A: Application parameters

Parameters for the setting of a specific application.

Pr. group	Pr.	Name	Refer to page
A000	135	Electronic bypass sequence selection	563
A001	136	MC switchover interlock time	563
A002	137	Start waiting time	563
A003	138	Bypass selection at a fault	563
A004	139	Automatic switchover frequency from inverter to bypass operation	563
A005	159	Automatic switchover frequency range from bypass to inverter operation	563
A006	248	Self power management selection	569
A007	254	Main circuit power OFF waiting time	569
A100	278	Brake opening frequency	572
A101	279	Brake opening current	572
A102	280	Brake opening current detection time	572
A103	281	Brake operation time at start	572
A104	282	Brake operation frequency	572
A105	283	Brake operation time at stop	572
A106	284	Deceleration detection function selection	572
A107	285	Overspeed detection frequency	572
A108	639	Brake opening current selection	572
A109	640	Brake operation frequency selection	572
A110	292	Automatic acceleration/ deceleration	384, 387, 572
A120	642	Second brake opening frequency	572
A121	643	Second brake opening current	572
A122	644	Second brake opening current detection time	572

Pr. group	Pr.	Name	Refer to page
A123	645	Second brake operation time at start	572
A124	646	Second brake operation frequency	572
A125	647	Second brake operation time at stop	572
A126	648	Second deceleration detection function selection	572
A128	650	Second brake opening current selection	572
A129	651	Second brake operation frequency selection	572
A130	641	Second brake sequence operation selection	572
A170	1410	Starting times lower 4 digits	576
A171	1411	Starting times upper 4 digits	576
A200	270	Stop-on contact/load torque high-speed frequency control selection	577, 580
A201	271	High-speed setting maximum current	580
A202	272	Middle-speed setting minimum current	580
A203	273	Current averaging range	580
A204	274	Current averaging filter time constant	580
A205	275	Stop-on contact excitation current low-speed scaling factor	577
A206	276	PWM carrier frequency at stop-on contact	577
A300	592	Traverse function selection	582
A301	593	Maximum amplitude amount	582
A302	594	Amplitude compensation amount during deceleration	582
A303	595	Amplitude compensation amount during acceleration	582
A304	596	Amplitude acceleration time	582
A305	597	Amplitude deceleration time	582
A310	1072	DC brake judgment time for anti-sway control operation	584
A311	1073	Anti-sway control operation selection	584
A312	1074	Anti-sway control frequency	584
A313	1075	Anti-sway control depth	584
A314	1076	Anti-sway control width	584
A315	1077	Rope length	584
A316	1078	Trolley weight	584
A317	1079	Load weight	584
A510	350 <sup>*1</sup>	Stop position command selection	585
A511	360 <sup>*1</sup>	16-bit data selection	585
A512	361 <sup>*1</sup>	Position shift	585
A520	362 <sup>*1</sup>	Orientation position loop gain	585
A521	363 <sup>*1</sup>	Completion signal output delay time	585
A522	364 <sup>*1</sup>	Encoder stop check time	585
A523	365 <sup>*1</sup>	Orientation limit	585
A524	366 <sup>*1</sup>	Recheck time	585
A525	393 <sup>*1</sup>	Orientation selection	585
A526	351 <sup>*1</sup>	Orientation speed	585
A527	352 <sup>*1</sup>	Creep speed	585
A528	353 <sup>*1</sup>	Creep switchover position	585

Pr. group	Pr.	Name	Refer to page
A529	354 <sup>*1</sup>	Position loop switchover position	585
A530	355 <sup>*1</sup>	DC injection brake start position	585
A531	356 <sup>*1</sup>	Internal stop position command	585
A532	357 <sup>*1</sup>	Orientation in-position zone	585
A533	358 <sup>*1</sup>	Servo torque selection	585
A540	394 <sup>*1</sup>	Number of machine side gear teeth	585
A541	395 <sup>*1</sup>	Number of motor side gear teeth	585
A542	396 <sup>*1</sup>	Orientation speed gain (P term)	585
A543	397 <sup>*1</sup>	Orientation speed integral time	585
A544	398 <sup>*1</sup>	Orientation speed gain (D term)	585
A545	399 <sup>*1</sup>	Orientation deceleration ratio	585
A546	829 <sup>*1</sup>	Number of machine end encoder pulses	585
A600	759	PID unit selection	615
A601	131	PID upper limit	601, 622
A602	132	PID lower limit	601, 622
A603	553	PID deviation limit	601
A604	554	PID signal operation selection	601
A605	1134	PID upper limit manipulated value	622
A606	1135	PID lower limit manipulated value	622
A607	1015	Integral stop selection at limited frequency	601
A610	128	PID action selection	601, 622
A611	133	PID action set point	601, 622
A612	127	PID control automatic switchover frequency	601
A613	129	PID proportional band	601, 622
A614	130	PID integral time	601, 622
A615	134	PID differential time	601, 622
A616	760	Pre-charge fault selection	618
A617	761	Pre-charge ending level	618
A618	762	Pre-charge ending time	618
A619	763	Pre-charge upper detection level	618
A620	764	Pre-charge time limit	618
A621	575	Output interruption detection time	601
A622	576	Output interruption detection level	601
A623	577	Output interruption cancel level	601
A624	609	PID set point/deviation input selection	601, 622
A625	610	PID measured value input selection	601, 622
A630	C42 (934) <sup>*2</sup>	PID display bias coefficient	615
A631	C43 (934) <sup>*2</sup>	PID display bias analog value	615
A632	C44 (935) <sup>*2</sup>	PID display gain coefficient	615
A633	C45 (935) <sup>*2</sup>	PID display gain analog value	615
A640	1142	Second PID unit selection	601
A641	1143	Second PID upper limit	601

Pr. group	Pr.	Name	Refer to page
A642	1144	Second PID lower limit	601
A643	1145	Second PID deviation limit	601
A644	1146	Second PID signal operation selection	601
A650	753	Second PID action selection	601
A651	755	Second PID action set point	601
A652	754	Second PID control automatic switchover frequency	601
A653	756	Second PID proportional band	601
A654	757	Second PID integral time	601
A655	758	Second PID differential time	601
A656	765	Second pre-charge fault selection	618
A657	766	Second pre-charge ending level	618
A658	767	Second pre-charge ending time	618
A659	768	Second pre-charge upper detection level	618
A660	769	Second pre-charge time limit	618
A661	1147	Second output interruption detection time	601
A662	1148	Second output interruption detection level	601
A663	1149	Second output interruption cancel level	601
A664	1140	Second PID set point/deviation input selection	601
A665	1141	Second PID measured value input selection	601
A670	1136	Second PID display bias coefficient	615
A671	1137	Second PID display bias analog value	615
A672	1138	Second PID display gain coefficient	615
A673	1139	Second PID display gain analog value	615
A680	573	4 mA input check selection	517
A681	777	4 mA input fault operation frequency	517
A682	778	4 mA input check filter	517
A700	162	Automatic restart after instantaneous power failure selection	628, 635, 638
A701	299	Rotation direction detection selection at restarting	628
A702	57	Restart coasting time	628, 635
A703	58	Restart cushion time	628
A704	163	First cushion time for restart	628
A705	164	First cushion voltage for restart	628
A710	165	Stall prevention operation level for restart	628
A711	298	Frequency search gain	532, 638
A712	560	Second frequency search gain	532, 638
A730	261	Power failure stop selection	642
A731	262	Subtracted frequency at deceleration start	642
A732	263	Subtraction starting frequency	642
A733	264	Power-failure deceleration time 1	642
A734	265	Power-failure deceleration time 2	642

Pr. group	Pr.	Name	Refer to page
A735	266	Power failure deceleration time switchover frequency	642
A785	294	UV avoidance voltage gain	642
A786	668	Power failure stop frequency gain	642
A800	414	PLC function operation selection	646
A801	415	Inverter operation lock mode setting	646
A802	416	Pre-scale function selection	646
A803	417	Pre-scale setting value	646
A804	498	PLC function flash memory clear	646
A805	675	User parameter auto storage function selection	646
A810 to A859	1150 to 1199	PLC function user parameters 1 to 50	646
A900	1020	Trace operation selection	649
A901	1021	Trace mode selection	649
A902	1022	Sampling cycle	649
A903	1023	Number of analog channels	649
A904	1024	Sampling auto start	649
A905	1025	Trigger mode selection	649
A906	1026	Number of sampling before trigger	649
A910	1027	Analog source selection (1ch)	649
A911	1028	Analog source selection (2ch)	649
A912	1029	Analog source selection (3ch)	649
A913	1030	Analog source selection (4ch)	649
A914	1031	Analog source selection (5ch)	649
A915	1032	Analog source selection (6ch)	649
A916	1033	Analog source selection (7ch)	649
A917	1034	Analog source selection (8ch)	649
A918	1035	Analog trigger channel	649
A919	1036	Analog trigger operation selection	649
A920	1037	Analog trigger level	649
A930	1038	Digital source selection (1ch)	649
A931	1039	Digital source selection (2ch)	649
A932	1040	Digital source selection (3ch)	649
A933	1041	Digital source selection (4ch)	649
A934	1042	Digital source selection (5ch)	649
A935	1043	Digital source selection (6ch)	649
A936	1044	Digital source selection (7ch)	649
A937	1045	Digital source selection (8ch)	649
A938	1046	Digital trigger channel	649
A939	1047	Digital trigger operation selection	649

## ◆ B: Position control parameters

Parameters for the position control setting.

Pr. group	Pr.	Name	Refer to page
B000	419	Position command source selection	303, 319
B001	420	Command pulse scaling factor numerator (electronic gear numerator)	325
B002	421	Command pulse multiplication denominator (electronic gear denominator)	325
B003	422	Position control gain	328
B004	423	Position feed forward gain	328

Pr. group	Pr.	Name	Refer to page
B005	424	Position command acceleration/deceleration time constant	325
B006	425	Position feed forward command filter	328
B007	426	In-position width	327
B008	427	Excessive level error	327
B009	428	Command pulse selection	319
B010	429	Clear signal selection	319
B011	430	Pulse monitor selection	319
B012	446	Model position control gain	328
B013	1298	Second position control gain	328
B020	464	Digital position control sudden stop deceleration time	303
B021	465	First target position lower 4 digits	303
B022	466	First target position upper 4 digits	303
B023	467	Second target position lower 4 digits	303
B024	468	Second target position upper 4 digits	303
B025	469	Third target position lower 4 digits	303
B026	470	Third target position upper 4 digits	303
B027	471	Fourth target position lower 4 digits	303
B028	472	Fourth target position upper 4 digits	303
B029	473	Fifth target position lower 4 digits	303
B030	474	Fifth target position upper 4 digits	303
B031	475	Sixth target position lower 4 digits	303
B032	476	Sixth target position upper 4 digits	303
B033	477	Seventh target position lower 4 digits	303
B034	478	Seventh target position upper 4 digits	303
B035	479	Eighth target position lower 4 digits	303
B036	480	Eighth target position upper 4 digits	303
B037	481	Ninth target position lower 4 digits	303
B038	482	Ninth target position upper 4 digits	303
B039	483	Tenth target position lower 4 digits	303
B040	484	Tenth target position upper 4 digits	303
B041	485	Eleventh target position lower 4 digits	303
B042	486	Eleventh target position upper 4 digits	303
B043	487	Twelfth target position lower 4 digits	303
B044	488	Twelfth target position upper 4 digits	303



Pr. group	Pr.	Name	Refer to page
B045	489	Thirteenth target position lower 4 digits	303
B046	490	Thirteenth target position upper 4 digits	303
B047	491	Fourteenth target position lower 4 digits	303
B048	492	Fourteenth target position upper 4 digits	303
B049	493	Fifteenth target position lower 4 digits	303
B050	494	Fifteenth target position upper 4 digits	303
B100	1220	Target position/speed selection	896
B101	1221	Start command edge detection selection	303
B120	1222	First positioning acceleration time	303
B121	1223	First positioning deceleration time	303
B122	1224	First positioning dwell time	303
B123	1225	First positioning sub-function	303
B124	1226	Second positioning acceleration time	303
B125	1227	Second positioning deceleration time	303
B126	1228	Second positioning dwell time	303
B127	1229	Second positioning sub-function	303
B128	1230	Third positioning acceleration time	303
B129	1231	Third positioning deceleration time	303
B130	1232	Third positioning dwell time	303
B131	1233	Third positioning sub-function	303
B132	1234	Fourth positioning acceleration time	303
B133	1235	Fourth positioning deceleration time	303
B134	1236	Fourth positioning dwell time	303
B135	1237	Fourth positioning sub-function	303
B136	1238	Fifth positioning acceleration time	303
B137	1239	Fifth positioning deceleration time	303
B138	1240	Fifth positioning dwell time	303
B139	1241	Fifth positioning sub-function	303
B140	1242	Sixth positioning acceleration time	303
B141	1243	Sixth positioning deceleration time	303
B142	1244	Sixth positioning dwell time	303
B143	1245	Sixth positioning sub-function	303
B144	1246	Seventh positioning acceleration time	303
B145	1247	Seventh positioning deceleration time	303
B146	1248	Seventh positioning dwell time	303
B147	1249	Seventh positioning sub-function	303
B148	1250	Eighth positioning acceleration time	303

Pr. group	Pr.	Name	Refer to page
B149	1251	Eighth positioning deceleration time	303
B150	1252	Eighth positioning dwell time	303
B151	1253	Eighth positioning sub-function	303
B152	1254	Ninth positioning acceleration time	303
B153	1255	Ninth positioning deceleration time	303
B154	1256	Ninth positioning dwell time	303
B155	1257	Ninth positioning sub-function	303
B156	1258	Tenth positioning acceleration time	303
B157	1259	Tenth positioning deceleration time	303
B158	1260	Tenth positioning dwell time	303
B159	1261	Tenth positioning sub-function	303
B160	1262	Eleventh positioning acceleration time	303
B161	1263	Eleventh positioning deceleration time	303
B162	1264	Eleventh positioning dwell time	303
B163	1265	Eleventh positioning sub-function	303
B164	1266	Twelfth positioning acceleration time	303
B165	1267	Twelfth positioning deceleration time	303
B166	1268	Twelfth positioning dwell time	303
B167	1269	Twelfth positioning sub-function	303
B168	1270	Thirteenth positioning acceleration time	303
B169	1271	Thirteenth positioning deceleration time	303
B170	1272	Thirteenth positioning dwell time	303
B171	1273	Thirteenth positioning sub-function	303
B172	1274	Fourteenth positioning acceleration time	303
B173	1275	Fourteenth positioning deceleration time	303
B174	1276	Fourteenth positioning dwell time	303
B175	1277	Fourteenth positioning sub-function	303
B176	1278	Fifteenth positioning acceleration time	303
B177	1279	Fifteenth positioning deceleration time	303
B178	1280	Fifteenth positioning dwell time	303
B179	1281	Fifteenth positioning sub-function	303
B180	1282	Home position return method selection	303
B181	1283	Home position return speed	303
B182	1284	Home position return shifting speed	303
B183	1285	Home position shift amount lower 4 digits	303

Pr. group	Pr.	Name	Refer to page
B184	1286	Home position shift amount upper 4 digits	303
B185	1287	Travel distance after proximity dog ON lower 4 digits	303
B186	1288	Travel distance after proximity dog ON upper 4 digits	303
B187	1289	Home position return stopper torque	303
B188	1290	Home position return stopper waiting time	303
B190	1292	Position control terminal input selection	303
B191	1293	Roll feeding mode selection	303
B192	1294	Position detection lower 4 digits	327
B193	1295	Position detection upper 4 digits	327
B194	1296	Position detection selection	327
B195	1297	Position detection hysteresis width	327

## ◆ N: Communication operation parameters

Parameters for the setting of communication operation such as the communication specifications or operating characteristics.

Pr. group	Pr.	Name	Refer to page
N000	549	Protocol selection	663
N001	342	Communication EEPROM write selection	663
N002	539	MODBUS RTU communication check time interval	686
N010	349 <sup>*6</sup>	Communication reset selection	663
N011	500 <sup>*6</sup>	Communication error execution waiting time	663
N012	501 <sup>*6</sup>	Communication error occurrence count display	663
N013	502	Stop mode selection at communication error	663
N014	779	Operation frequency during communication error	663
N020	117	PU communication station number	670
N021	118	PU communication speed	670
N022	119	PU communication data length	670
N023	119	PU communication stop bit length	670
N024	120	PU communication parity check	670
N025	121	PU communication retry count	670
N026	122	PU communication check time interval	670
N027	123	PU communication waiting time setting	670
N028	124	PU communication CR/LF selection	670
N030	331	RS-485 communication station number	670
N031	332	RS-485 communication speed	670

Pr. group	Pr.	Name	Refer to page
N032	333	RS-485 communication data length	670
N033	333	RS-485 communication stop bit length	670
N034	334	RS-485 communication parity check selection	670
N035	335	RS-485 communication retry count	670
N036	336	RS-485 communication check time interval	670
N037	337	RS-485 communication waiting time setting	670
N038	341	RS-485 communication CR/LF selection	670
N040	547	USB communication station number	701
N041	548	USB communication check time interval	701
N080	343	Communication error count	686
N100	541 <sup>*6</sup>	Frequency command sign selection	699
N110	434 <sup>*6</sup>	Network number (CC-Link IE)	699
N111	435 <sup>*6</sup>	Station number (CC-Link IE)	699
N240	349 <sup>*6</sup>	Ready bit status selection	663
N241	349 <sup>*6</sup>	Reset selection after inverter faults are cleared	893
N242	349 <sup>*6</sup>	DriveControl writing restriction selection	893
N500 to N543, N550 to N559	1300 to 1343, 1350 to 1359	Communication option parameters. For details, refer to the Instruction Manual of the option.	

## ◆ G: Control parameters

Parameters for motor control.

Pr. group	Pr.	Name	Refer to page
G000	0	Torque boost <a href="#">Simple</a>	706
G001	3	Base frequency <a href="#">Simple</a>	707
G002	19	Base frequency voltage	707
G003	14	Load pattern selection	708
G010	46	Second torque boost	706
G011	47	Second V/F (base frequency)	707
G020	112	Third torque boost	706
G021	113	Third V/F (base frequency)	707
G030	60	Energy saving control selection	712
G040	100	V/F1 (first frequency)	713
G041	101	V/F1 (first frequency voltage)	713
G042	102	V/F2 (second frequency)	713
G043	103	V/F2 (second frequency voltage)	713
G044	104	V/F3 (third frequency)	713
G045	105	V/F3 (third frequency voltage)	713
G046	106	V/F4 (fourth frequency)	713
G047	107	V/F4 (fourth frequency voltage)	713
G048	108	V/F5 (fifth frequency)	713
G049	109	V/F5 (fifth frequency voltage)	713
G060	673	SF-PR slip amount adjustment operation selection	714

Pr. group	Pr.	Name	Refer to page
G061	674	SF-PR slip amount adjustment gain	714
G080	617	Reverse rotation excitation current low-speed scaling factor	711
G100	10	DC injection brake operation frequency	715
G101	11	DC injection brake operation time	715
G102	802	Pre-excitation selection	715
G103	850	Brake operation selection	715
G105	522	Output stop frequency	720
G106	250	Stop selection	722
G107	70 <sup>*3</sup>	Special regenerative brake duty	724
G108	1299	Second pre-excitation selection	715
G110	12	DC injection brake operation voltage	715
G120	882	Regeneration avoidance operation selection	732
G121	883	Regeneration avoidance operation level	732
G122	884	Regeneration avoidance at deceleration detection sensitivity	732
G123	885	Regeneration avoidance compensation frequency limit value	732
G124	886	Regeneration avoidance voltage gain	732
G125	665	Regeneration avoidance frequency gain	732
G130	660	Increased magnetic excitation deceleration operation selection	735
G131	661	Magnetic excitation increase rate	735
G132	662	Increased magnetic excitation current level	735
G200	800	Control method selection	221
G201	85	Excitation current break point	711
G202	86	Excitation current low-speed scaling factor	711
G203	245	Rated slip	736
G204	246	Slip compensation time constant	736
G205	247	Constant output range slip compensation selection	736
G206	1116	Constant output range speed control P gain compensation	254
G210	803	Constant output range torque characteristic selection	245, 283
G211	820	Speed control P gain 1	254
G212	821	Speed control integral time 1	254
G213	824	Torque control P gain 1 (current loop proportional gain)	294, 333
G214	825	Torque control integral time 1 (current loop integral time)	294, 333
G215	823 <sup>*1</sup>	Speed detection filter 1	332
G216	827	Torque detection filter 1	332
G217	854	Excitation ratio	332

Pr. group	Pr.	Name	Refer to page
G218	1115	Speed control integral term clear time	254
G220	877	Speed feed forward control/ model adaptive speed control selection	263
G221	878	Speed feed forward filter	263
G222	879	Speed feed forward torque limit	263
G223	881	Speed feed forward gain	263
G224	828	Model speed control gain	263
G230	840	Torque bias selection	265
G231	841	Torque bias 1	265
G232	842	Torque bias 2	265
G233	843	Torque bias 3	265
G234	844	Torque bias filter	265
G235	845	Torque bias operation time	265
G236	846	Torque bias balance compensation	265
G237	847	Fall-time torque bias terminal 1 bias	265
G238	848	Fall-time torque bias terminal 1 gain	265
G240	367 <sup>*1</sup>	Speed feedback range	736
G241	368 <sup>*1</sup>	Feedback gain	736
G250	788	Low speed range torque characteristic selection	233
G260	1121	Per-unit speed control reference frequency	254
G261	1117	Speed control P gain 1 (per-unit system)	254
G262	1119	Model speed control gain (per-unit system)	263
G263	1348	P/PI control switchover frequency	254
G264	1349	Emergency stop operation selection	367
G300	451	Second motor control method selection	221
G301	565	Second motor excitation current break point	711
G302	566	Second motor excitation current low-speed scaling factor	711
G311	830	Speed control P gain 2	254
G312	831	Speed control integral time 2	254
G313	834	Torque control P gain 2 (current loop proportional gain)	294
G314	835	Torque control integral time 2 (current loop integral time)	294
G315	833 <sup>*1</sup>	Speed detection filter 2	332
G316	837	Torque detection filter 2	332
G350	747	Second motor low-speed range torque characteristic selection	233
G361	1118	Speed control P gain 2 (per-unit system)	254
G400	286	Droop gain	738
G401	287	Droop filter time constant	738
G402	288	Droop function activation selection	738
G403	994	Droop break point gain	738

Pr. group	Pr.	Name	Refer to page
G404	995	Droop break point torque	738
G410	653	Speed smoothing control	741
G411	654	Speed smoothing cutoff frequency	741
G420	679	Second droop gain	738
G421	680	Second droop filter time constant	738
G422	681	Second droop function activation selection	738
G423	682	Second droop break point gain	738
G424	683	Second droop break point torque	738
G601	1003	Notch filter frequency	271
G602	1004	Notch filter depth	271
G603	1005	Notch filter width	271

Pr. group	Pr.	Name	Refer to page
G932	89	Speed control gain (Advanced magnetic flux vector)	228
G942	569	Second motor speed control gain	228

- \*1 The setting is available when a plug-in option for Vector control is installed.
- \*2 On the LCD operation panel or the parameter unit used as the command source, the parameter number in parentheses appears instead of that starting with the letter C.
- \*3 The setting is available for the standard model.
- \*4 The setting is available for the standard model and the IP55 compatible model.
- \*5 The setting is available when the PLC function is enabled.
- \*6 The setting is available for the FR-A800-GF or when a compatible plug-in option is installed.
- \*7 Refer to the FR-A8AVP Instruction Manual (For Inverter/ Converter Switching).

## 5.2 Control method

V/F control (initial setting), Advanced magnetic flux vector control, Real sensorless vector control, Vector control, and PM sensorless vector control are available with this inverter.

### ◆ V/F control

The inverter controls the output frequency (F) and the output voltage (V) so that the ratio of frequency to voltage (V/F) is kept constant when the frequency is changed.

### ◆ Advanced magnetic flux vector control

The inverter performs vector calculation and divide its output current into the excitation current and the torque current. The inverter compensates the frequency and the voltage to output a current that meets the load torque to the motor, which improves the motor torque at low speed. The output frequency is further compensated (slip compensation) to bring the actual motor speed closer to the commanded speed. This control method is useful when the load fluctuates are severe.

#### NOTE

- Advanced magnetic flux vector control requires the following conditions.  
If these conditions are not satisfied, select V/F control. Otherwise, malfunctions such as insufficient torque, uneven rotation may occur.
- For the motor capacity, the rated motor current should be equal to or less than the rated inverter current. (It must be 0.4 kW or higher.)  
If a motor with substantially low rated current compared with the inverter rated current, however, is used, speed and torque accuracies may deteriorate due to torque ripples, etc. Set the rated motor current to about 40% or higher of the inverter rated current.
- The motor described in the following table is used.

Motor	Condition
Mitsubishi Electric standard motor (SF-JR)	The offline auto tuning is not required.
Mitsubishi Electric high-efficiency motor (SF-HR)	
Mitsubishi Electric constant-torque motor (SF-JRCA 4P / SF-HRCA)	
Mitsubishi Electric high-performance energy-saving motor (SF-PR)	
Other motor (Mitsubishi motor SF-TH, etc. or other manufacturer's motor)	The offline auto tuning is required.

- Single-motor operation (one motor to one inverter) is performed.
- The wiring length from inverter to motor is 30 m or less. (When the wiring length exceeds 30 m, perform offline auto tuning with the wiring in place.)
- A sine wave filter (MT-BSL/BSC) is not used.

### ◆ Real sensorless vector control

- As the inverter estimates the motor speed and controls the output current more accurately, a high-level control of the speed and the torque is enabled. Select Real sensorless vector control for a high-accuracy, fast-response control. The offline auto tuning is required initially.
- This control method is useful for the following purposes:
  - To minimize the speed fluctuation even at a severe load fluctuation
  - To generate a low speed torque
  - To prevent machine from damage due to a too large torque (To set the torque limit)
  - To control the torque

## NOTE

- Real sensorless vector control requires the following conditions.  
If these conditions are not satisfied, select V/F control. Otherwise, malfunctions such as insufficient torque, uneven rotation may occur.
- For the motor capacity, the rated motor current should be equal to or less than the rated inverter current. (It must be 0.4 kW or higher.)  
If a motor with substantially low rated current compared with the inverter rated current, however, is used, speed and torque accuracies may deteriorate due to torque ripples, etc. Set the rated motor current to about 40% or higher of the inverter rated current.
- Offline auto tuning is performed.  
Offline auto tuning is necessary under Real sensorless vector control even when the Mitsubishi Electric motor is used.
- Single-motor operation (one motor to one inverter) is performed.
- A surge voltage suppression filter (FR-ASF/FR-BMF) or sine wave filter (MT-BSL/BSC) is not used.

## ◆ Vector control

- With a vector control option installed, full-scale vector control operation of a motor with an encoder can be performed. Speed control (zero speed control, servo lock), torque control, and position control can be performed with fast response and high accuracy.
- Vector control has excellent control characteristic compared to other control methods such as V/F control. Its control characteristic is equal to those of DC machines.
- This control method is useful for the following purposes:
  - To minimize the speed fluctuation even at a severe load fluctuation
  - To generate a low speed torque
  - To prevent machine from damage due to a too large torque (To set the torque limit)
  - To control the torque or position
  - To control a torque generated in a motor in a servo-lock state (the motor with its shaft stopped)

## NOTE

- Vector control requires the following conditions.  
When the conditions are not satisfied, malfunctions such as insufficient torque, uneven rotation may occur.
- The rated motor current should be equal to or less than the inverter rated current. (It must be 0.4 kW or higher.)  
If a motor with substantially low rated current compared with the inverter rated current, however, is used, speed and torque accuracies may deteriorate due to torque ripples, etc. Set the rated motor current to about 40% or higher of the inverter rated current.
- Torque control is not available for a PM motor.
- The motor described in the following table is used.

Motor	Condition
Vector control dedicated motor SF-V5RU (1500 r/min series)	The offline auto tuning is not required.
Mitsubishi Electric standard motor with encoder (SF-JR)	
Mitsubishi Electric high-efficiency motor with encoder (SF-HR)	
Mitsubishi Electric constant-torque motor with encoder (SF-JRCA 4P, SF-HRCA)	
Other motors (motors other than SF-V5RU 1500 r/min series, other manufactures' motors, etc.)	The offline auto tuning is required.

- Single-motor operation (one motor to one inverter) is performed.
- The wiring length from inverter to motor is 30 m or less. (When the wiring length exceeds 30 m, perform offline auto tuning with the wiring in place.)
- A surge voltage suppression filter (FR-ASF/FR-BMF) or sine wave filter (MT-BSL/BSC) is not used.

## ◆ PM sensorless vector control

- The inverter enables highly efficient motor control and highly accurate motor speed control of a PM (permanent magnet embedded) motor, which is more efficient than an induction motor.
- A speed detector such as an encoder is not required as the inverter estimates the motor speed by the calculation from the inverter output voltage and current. The inverter drives the PM motor with the least required current for a load in order to achieve the highest motor efficiency.

- When using an IPM motor MM-CF, simply performing the motor parameter initialization (PM parameter initialization or IPM initialization) enables PM sensorless vector control.

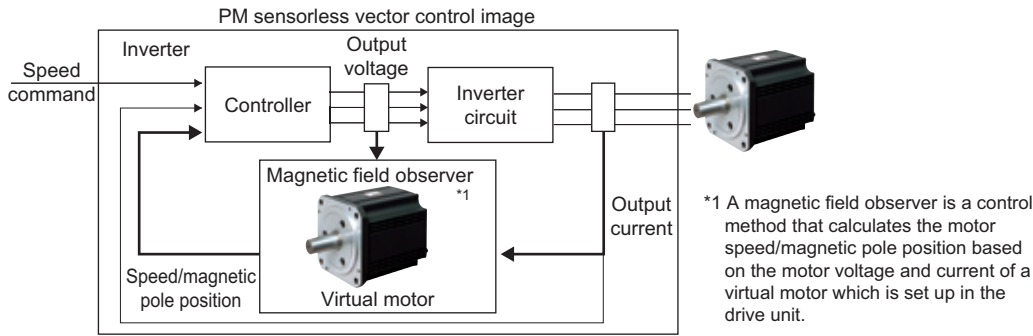

## NOTE

- The PM sensorless vector control requires the following conditions.
- The motor described in the following table is used.

Motor	Condition
Mitsubishi Electric IPM motor (MM-CF)	The offline auto tuning is not required.
IPM motor (other than MM-CF), SPM motor	The offline auto tuning is required.

- For the motor capacity, the rated motor current should be equal to or less than the rated inverter current. (It must be 0.4 kW or higher.)  
If a motor with substantially low rated current compared with the inverter rated current, however, is used, speed and torque accuracies may deteriorate due to torque ripples, etc. Set the rated motor current to about 40% or higher of the inverter rated current.
- Single-motor operation (one motor to one inverter) is performed.
- The wiring length from the inverter to the motor is 100 m or less. (Refer to [page 66](#).) (When the wiring length from the inverter to the IPM motor MM-CF exceeds 30 m, perform offline auto tuning.)
- A surge voltage suppression filter (FR-ASF/FR-BMF) or sine wave filter (MT-BSL/BSC) is not used.

## 5.2.1 Vector control and Real sensorless vector control

Vector control is one of the control techniques for driving an induction motor. To help explain Vector control, the fundamental equivalent circuit of an induction motor is shown below.

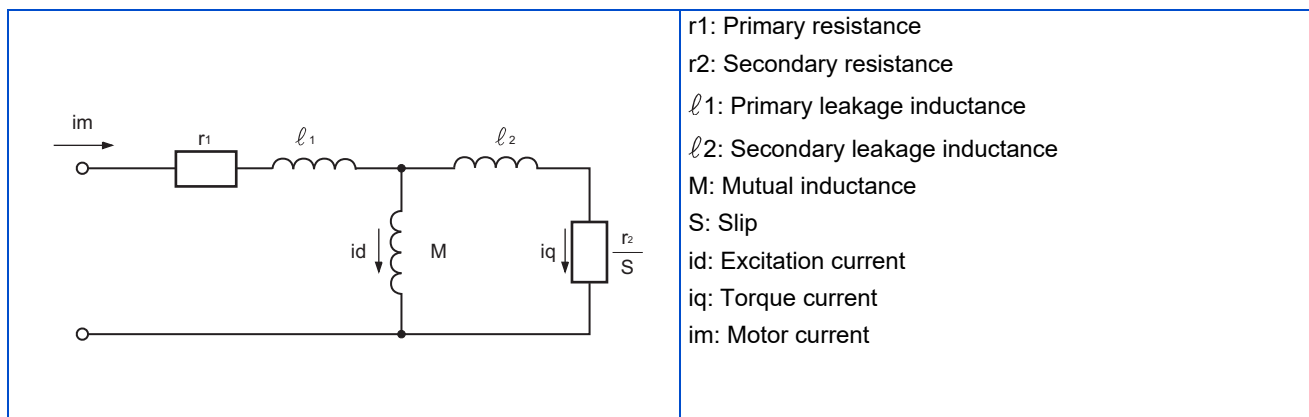

In the above diagram, currents flowing in the induction motor can be classified into a current  $i_d$  (excitation current) for making a magnetic flux in the motor and a current  $i_q$  (torque current) for causing the motor to develop torque.



In Vector control, the voltage and output frequency are calculated to control the motor so that the excitation current and torque current flow to the optimum as described below:

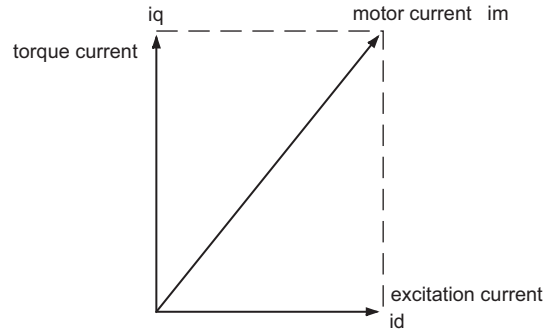

- The excitation current is controlled to place the internal magnetic flux of the motor in the optimum status.
- The torque command value is derived so that the difference between the motor speed command and the actual speed (speed estimated value for Real sensorless vector control) obtained from the encoder connected to the motor shaft is zero. Torque current is controlled so that torque as set in the torque command is developed.

Motor-generated torque ( $T_M$ ), slip angular velocity ( $\omega_s$ ) and the motor's secondary magnetic flux ( $\Phi_2$ ) can be found by the following calculation:

$$T_M \propto \Phi_2 \cdot i_q$$

$$\Phi_2 = M \cdot i_d$$

$$\omega_s = \frac{r_2}{L_2} \cdot \frac{i_q}{i_d}$$

where,  $L_2$ : secondary inductance

$$L_2 = \ell_2 + M$$

Vector control provides the following advantages:

- Vector control has excellent control characteristic compared to V/F control and other controls. The control characteristic of the Vector control is equal to those of DC machines.
- It is applicable to fast response applications with which induction motors were previously regarded as difficult to use. Applications requiring a wide variable-speed range from extremely low speed to high speed, frequent acceleration/ deceleration operations, continuous four-quadrant operations, etc.
- Torque control is enabled (when an induction motor is used).
- It allows servo-lock torque control which generates a torque in the motor shaft while stopped. (Not available under Real sensorless vector control.)



**Block diagram of Real sensorless vector control**

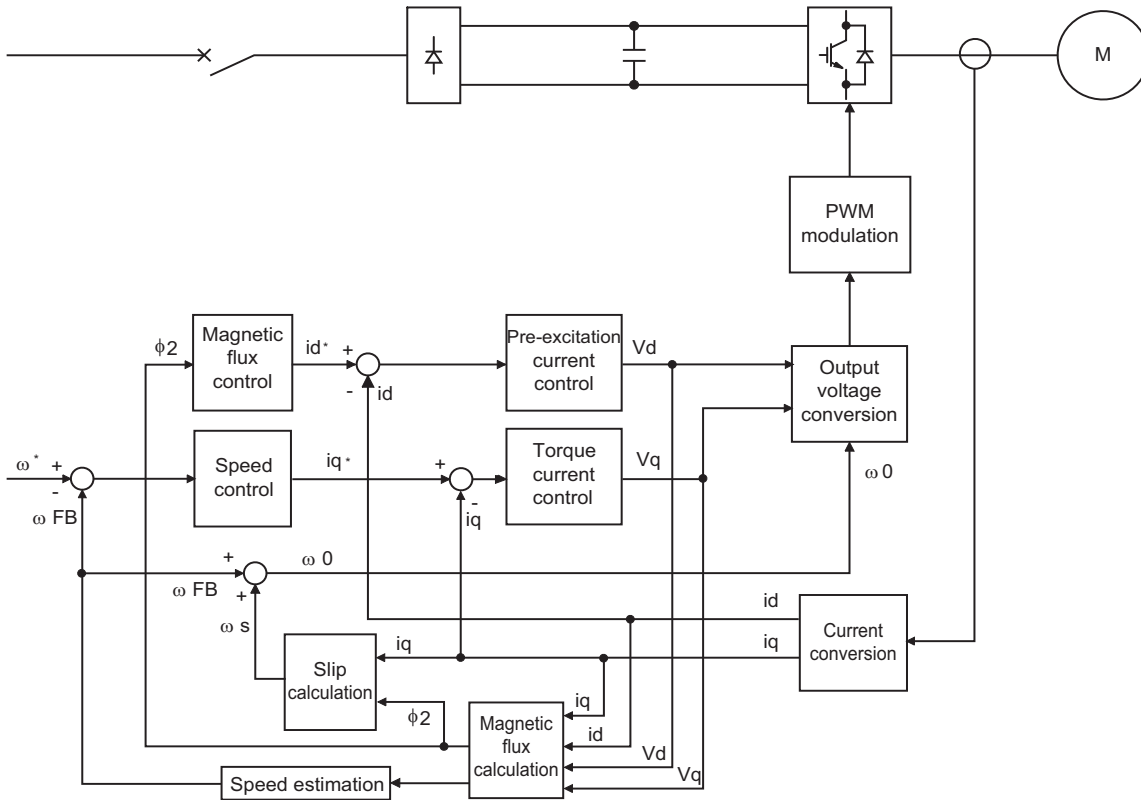

**Block diagram of Vector control**

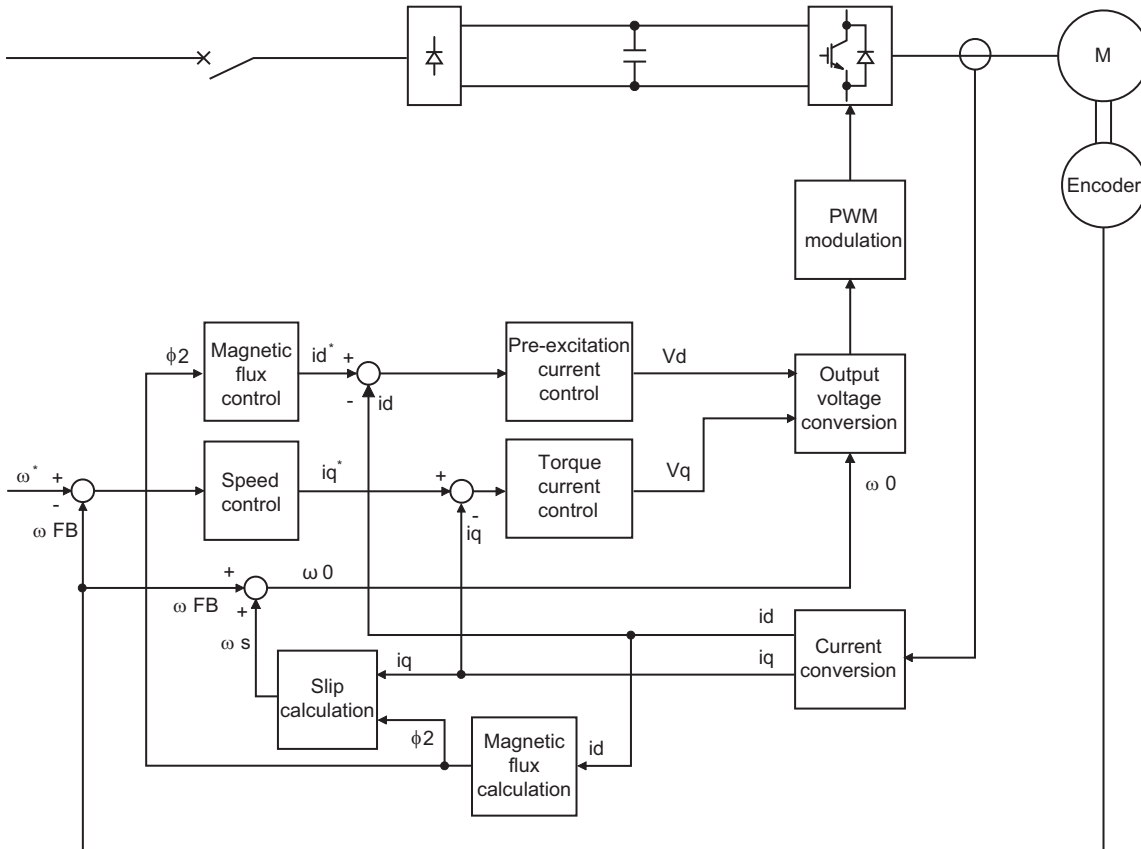

<b>Speed control</b>	Speed control operation is performed to zero the difference between the speed command ( $\omega^*$ ) and actual rotation value detected by encoder ( $\omega_{FB}$ ). At this time, the motor load is found and its result is transferred to the torque current controller as a torque current command ( $i_q^*$ ).
<b>Torque current control</b>	A voltage ( $V_q$ ) is calculated to flow a current ( $i_q$ ) which is identical to the torque current command ( $i_q^*$ ) found by the speed controller.
<b>Magnetic flux control</b>	The magnetic flux ( $\Phi_2$ ) of the motor is derived from the excitation current ( $i_d$ ). The excitation current command ( $i_d^*$ ) is calculated to use that motor magnetic flux ( $\Phi_2$ ) as a predetermined magnetic flux.
<b>Excitation current control</b>	A voltage ( $V_d$ ) is calculated to flow a current ( $i_d$ ) which is identical to the excitation current command ( $i_d^*$ ).
<b>Output frequency calculation</b>	Motor slip ( $\omega_s$ ) is calculated on the basis of the torque current value ( $i_q$ ) and magnetic flux ( $\Phi_2$ ). The output frequency ( $\omega_0$ ) is found by adding that slip ( $\omega_s$ ) to the feedback ( $\omega_{FB}$ ) found by a feedback from the encoder.

The above results are used to make PWM modulation and run the motor.

## 5.2.2 Changing the control method and mode

Set the control method and the control mode.

V/F control, Advanced magnetic flux vector control, Real sensorless vector control, Vector control, and PM sensorless vector control are the control methods available for selection.

The available control modes are speed control, torque control, and position control modes.

Select a control mode under Real sensorless vector control, Vector control, and PM sensorless vector control. Under Real sensorless vector control, select a control mode from the speed control and torque control modes. Under Vector control, select a control mode from the speed control, torque control, and position control modes. The control method is initially set to V/F control.

When using an IPM motor MM-CF, simply performing the IPM parameter initialization enables the PM sensorless vector control and selects the speed control and position control.

- Select a control method and a control mode by setting **Pr.800 (Pr.451) Control method selection**.
- The control mode can be switched using a mode switching signal (MC).

Pr.	Name	Initial value	Setting range	Description	
71 C100	Applied motor	0	0 to 6, 13 to 16, 20, 23, 24, 30, 33, 34, 40, 43, 44, 50, 53, 54, 70, 73, 74, 330, 333, 334, 8090, 8093, 8094, 9090, 9093, 9094	By selecting a standard motor or constant-torque motor, the thermal characteristic and motor constant of each motor are set.	
80 C101	Motor capacity	9999	0.4 to 55 kW <sup>*1</sup>	Set the applied motor capacity.	
			0 to 3600 kW <sup>*2</sup>		
81 C102	Number of motor poles	9999	2, 4, 6, 8, 10, 12	Set the number of motor poles.	
			9999	V/F control	
83 C104	Rated motor voltage	200/400 V <sup>*3</sup>	0 to 1000 V	Set the rated motor voltage (V).	
84 C105	Rated motor frequency	9999	10 to 400 Hz	Set the rated motor frequency (Hz).	
			9999	The setting value of <b>Pr.3 Base frequency</b> is used. <sup>*4</sup>	
800 G200	Control method selection	20	0 to 6	Vector control	
			9	Vector control, PM sensorless vector control test operation	
			10 to 12	Real sensorless vector control	
			13, 14	PM sensorless vector control	
			20	V/F control / Advanced magnetic flux vector control / PM sensorless vector control	
			100 to 106	Vector control	Fast-response operation
			109	Vector control, PM sensorless vector control test operation	
			110 to 112	Real sensorless vector control	
110, 113, 114	PM sensorless vector control				
451 G300	Second motor control method selection	9999	0 to 6	Vector control	
			10 to 12	Real sensorless vector control	
			13, 14	PM sensorless vector control	
			20	V/F control (Advanced magnetic flux vector control)	
			100 to 106	Vector control	Fast-response operation
			110 to 112	Real sensorless vector control	
			110, 113, 114	PM sensorless vector control	
			9999	Advanced magnetic flux vector control when the induction motor is selected in <b>Pr.71</b> . <sup>*5</sup> As set in <b>Pr.800</b> when the PM motor is selected in <b>Pr.71</b> .	

\*1 For the FR-A820-03160(55K) or lower, and FR-A840-01800(55K) or lower.

\*2 For the FR-A820-03800(75K) or higher, and FR-A840-02160(75K) or higher.

\*3 The initial value differs according to the inverter's voltage class (200/400 V class).

\*4 When the IPM motor MM-CF is selected in **Pr.71 Applied motor**, the rated frequency of the MM-CF is used. When a PM motor other than the MM-CF is selected for **Pr.71**, 75 Hz (for the motor capacity 15 kW or lower) or 100 Hz (18.5 kW or higher) is used.

\*5 V/F control is set when **Pr.453** and **Pr.454** = "9999".

## ◆ Setting the motor capacity and the number of motor poles (Pr.80, Pr.81)

- Motor specifications (the motor capacity and the number of motor poles) must be set to select Advanced magnetic flux vector control, Real sensorless vector control, Vector control, or PM sensorless vector control.
- Set the motor capacity (kW) in **Pr.80 Motor capacity** and set the number of motor poles in **Pr.81 Number of motor poles**.

### NOTE

- Setting the number of motor poles in **Pr.81** changes the **Pr.144 Speed setting switchover** setting automatically. (Refer to [page 444.](#))

## ◆ Selection of the control method and the control mode

- Select a control method (and a control mode) from V/F control (speed control), Advanced magnetic flux vector control (speed control), Real sensorless vector control (speed control or torque control), Vector control (speed control, torque control, or position control), or PM sensorless vector control (speed control or position control).

Settings of Pr.80 (Pr.453) and Pr.81 (Pr.454)	Pr.71 (Pr.450)	Pr.800 setting <sup>*1</sup>	Pr.451 setting <sup>*1</sup>	Control method	Control mode	Remarks		
Other than 9999	Induction motor <sup>*3</sup>	0, 100		Vector control <sup>*2</sup>	Speed control	—		
		1, 101			Torque control	—		
		2, 102			Speed control / torque control switchover	MC signal ON: torque control MC signal OFF: speed control		
		3, 103			Position control	—		
		4, 104			Speed control / position control switchover	MC signal ON: position control MC signal OFF: speed control		
		5, 105			Position control / torque control switchover	MC signal ON: torque control MC signal OFF: position control		
		6, 106			Torque control (variable-current limiter control)	—		
		9, 109	—		Vector control test operation			
		10, 110			Real sensorless vector control	Speed control	—	
		11, 111				Torque control	—	
		12, 112				Speed control / torque control switchover	MC signal ON: torque control MC signal OFF: speed control	
		20 (initial value)			20	Advanced magnetic flux vector control	Speed control	—
	—		9999 (initial value)	Advanced magnetic flux vector control for the second motor				
	IPM motor (MM-CF) <sup>*4</sup>	9, 109	—	PM sensorless vector control test operation				
		13, 113		PM sensorless vector control	Position control <sup>*6</sup>	—		
		14, 114			Speed control / position control switchover <sup>*6</sup>	MC signal ON: position control MC signal OFF: speed control		
		20 (initial value), 110	20, 110		Speed control	—		
	20 (initial value), 110 <sup>*10</sup>		PM sensorless vector control		Speed control	—		
	IPM/SPM motor (other than MM-CF)	0, 100 <sup>*7</sup>		Vector control <sup>*9</sup>	Speed control	—		
		3, 103			Position control	—		
		4, 104 <sup>*8</sup>			Speed control / position control switchover	MC signal ON: position control MC signal OFF: speed control		
		9, 109	—		PM sensorless vector control test operation			
		20 (initial value), 110 <sup>*10</sup>	20, 110 <sup>*10</sup>		PM sensorless vector control	Speed control	—	
IPM/SPM motor		—	9999 (initial value)		The setting value of <b>Pr.800</b> is used for the second motor. (PM sensorless vector control (speed control) when <b>Pr.800</b> = "9 or 109")			
9999 <sup>*5</sup>	—	—	V/F control					

\*1 The setting values of 100 and above are used when the fast-response operation is selected.

\*2 Advanced magnetic flux vector control is applied if a Vector control compatible option is not installed.

\*3 For an induction motor, the setting "13, 14, 113, or 114" in **Pr.800 (Pr.451)** has the same meaning as the setting "10 or 110" in **Pr.800 (Pr.451)** (speed control under Real sensorless vector control).

- \*4 For the IPM motor MM-CF, the setting other than "9, 13, 14, 109, 113, 114, or 9999" in **Pr.800 (Pr.451)** has the same meaning as the setting "20 or 110" in **Pr.800 (Pr.451)** (speed control under PM sensorless vector control).
- \*5 V/F control is applied when **Pr.80** or **Pr.81** is "9999", regardless of the **Pr.800** setting. When **Pr.71** is set to the IPM motor MM-CF, PM sensorless vector control is enabled even if **Pr.80** ≠ "9999" or **Pr.81** = "9999". (When other PM motors are used, set **Pr.80** and **Pr.81** according to the motor. Otherwise, proper operation cannot be performed.)
- \*6 Setting **Pr.788 (Pr.747)** = "0" (low-speed range torque characteristic disabled) selects speed control.
- \*7 The operation for the setting of "0 or 100" is performed when "1, 2, 6, 101, 102, or 106" is set.
- \*8 The operation for the setting of "4 or 104" is performed when "5 or 105" is set.
- \*9 Speed control under PM sensorless vector control is applied if an option for vector control for PM motor is not installed.
- \*10 The operation for the setting of "20 or 110" is performed when "10 to 14 or 111 to 114" is set.

## ◆ Selecting the fast-response operation (Pr.800 (Pr.451) = "100 to 106, or 109 to 114")

- Setting **Pr.800 (Pr.451)** = "any of 100 to 106 or 109 to 114" selects the fast-response operation. The fast-response operation is available during Vector control, Real sensorless vector control, and PM sensorless vector control.

Control method	Speed response	
	Fast-response operation Pr.800 (Pr.451) = "100 to 106, or 109 to 114"	Normal-response operation Pr.800 (Pr.451) = "0 to 6, or 9 to 14"
Vector control	130 Hz at maximum	50 Hz at maximum
Real sensorless vector control	50 Hz at maximum <sup>*1</sup>	20 Hz at maximum <sup>*2</sup>
		10 Hz at maximum <sup>*3</sup>
PM sensorless vector control	50 Hz at maximum	30 Hz at maximum

\*1 When driving a 3.7 kW no-load motor.

\*2 For the FR-A820-03160(55K) or lower, and FR-A840-01800(55K) or lower.

\*3 For the FR-A820-03800(75K) or higher, and FR-A840-02160(75K) or higher.

### NOTE

- During fast-response operation, the carrier frequency is always 4 kHz. (Refer to [page 356](#).)
- The inverter overload trip (E.THT) is more likely to occur when fast-response operation is set at the SLD or LD rating.

## ◆ Vector control test operation, PM sensorless vector control test operation (Pr.800 = "9 or 109")

- A test operation for speed control is available without connecting a motor to the inverter. The speed calculation changes to track the speed command, and such speed changes can be checked on the operation panel or by outputting it as analog signals to terminal FM/CA or AM.

### NOTE

- Since current is not detected and voltage is not output, monitors related to current and voltage such as output current and output voltage, etc. and output signals do not function.
- For speed calculation, speed is calculated in consideration of **Pr.880 Load inertia ratio**.
- Since current synchronization operation occurs during the test operation for PM sensorless vector control, the output frequency becomes the same value as the command frequency.

## ◆ I/O signal status during the test operation

- During the test operation, the following signals are disabled.

Input terminal function selection (Pr.178 to Pr.189)	Output terminal function selection (Pr.190 to Pr.196)
<ul style="list-style-type: none"> <li>• Brake opening completion (BRI)</li> <li>• Load pattern selection forward/reverse rotation boost (X17)</li> <li>• V/F switchover (X18)</li> <li>• Orientation command (X22)</li> <li>• Control mode switchover (MC)</li> <li>• Start-time tuning start external input (X28)</li> <li>• Torque bias selection 1, Torque bias selection 2 (X42, X43)</li> <li>• Second brake sequence open completion (BRI2)</li> <li>• Torque limit selection (X93)</li> </ul>	<ul style="list-style-type: none"> <li>• Electronic thermal O/L relay pre-alarm (THP)</li> <li>• Brake opening request (BOF)</li> <li>• Second brake opening request (BOF2)</li> <li>• Orientation complete (ORA)</li> <li>• Orientation fault (ORM)</li> <li>• Regenerative status output (Y32)</li> <li>• In-position (Y36)</li> <li>• Travel completed (MEND)</li> <li>• Start time tuning completion (Y39)</li> <li>• Home position return failure (ZA)</li> <li>• Position detection level (FP)</li> <li>• During position command operation (PBSY)</li> <li>• Home position return completed (ZP)</li> </ul>

### Parameters referred to

Pr.178 to Pr.189 (Input terminal function selection) [page 521](#)

Pr.190 to Pr.196 (Output terminal function selection) [page 473](#)

## ◆ Status of the monitoring during the test operation

○: Enabled

×: Disabled (0 is displayed at any time.)

Δ: A cumulative total before the test operation is displayed.

—: Not available

Monitor item	Monitoring on DU/PU	Output via FM/CA/AM	Monitor item	Monitoring on DU/PU	Output via FM/CA/AM
Output frequency	○	○	PID deviation	○	○ <sup>*3</sup>
Fault indication	○	—	Input terminal status	○	—
Frequency setting value	○	○	Output terminal status	○	—
Motor speed	○	○	Option input terminal status	○	—
Converter output voltage	○	○	Option output terminal status	○	—
Electronic thermal O/L relay load factor	× <sup>*2</sup>	× <sup>*2</sup>	Motor thermal load factor	○ <sup>*4</sup>	○ <sup>*4</sup>
Output current peak value	× <sup>*2</sup>	× <sup>*2</sup>	Inverter thermal load factor	○ <sup>*4</sup>	○ <sup>*4</sup>
Converter output voltage peak value	○	○	PTC thermistor value	○	—
Load meter	○	○	PID measured value 2	○	○
Cumulative energization time	○	—	Remote output 1	○	○
Reference voltage output	—	○	Remote output 2	○	○
Actual operation time	○	—	Remote output 3	○	○
Cumulative energy	Δ	—	Remote output 4	○	○
Trace status	○	×	PID manipulated variable	○	○ <sup>*3</sup>
Station number (RS-485 terminals)	○	—	Second PID set point	○	○
Station number (PU connector)	○	—	Second PID measured value	○	○
Station number (CC-Link)	○	—	Second PID deviation	○	○ <sup>*3</sup>
Energy saving effect	○	○	Second PID measured value 2	○	○
Cumulative energy saving	Δ	—	Second PID manipulated variable	○	○ <sup>*3</sup>
PID set point	○	○	Dancer main speed setting	○	○
PID measured value	○	○			

\*1 The monitoring-enabled items differ depending on the output interface (operation panel, parameter unit, terminal FM/CA, or terminal AM). For the details, refer to [page 457](#).

\*2 When the inverter operation is switched to the test operation, the indication is changed to 0. When PM sensorless vector control is selected again after the test operation, the output current peak value and the electronic thermal relay load factor from the last operation are displayed.

\*3 The output is enabled via terminal AM only.

\*4 When the inverter operation is switched to the test operation, the accumulated thermal value is reduced because the output current is considered as 0.

### Parameters referred to

Pr.52 Operation panel main monitor selection [page 446](#)

Pr.158 AM terminal function selection [page 457](#)

## ◆ Changing the control method with external terminals (RT signal, X18 signal)

- Control method (V/F control, Advanced magnetic flux vector control, Real sensorless vector control, Vector control) can be switched using external terminals.  
The control method can be switched using either the Second function selection (RT) signal or the V/F switchover (X18) signal.
- When using the RT signal, set the second motor in **Pr.450 Second applied motor** and set the second motor's control method in **Pr.451 Second motor control method selection**. Turning ON the RT signal enables the second function, enabling the switchover of the control method.

- When using the X18 signal, turning ON the X18 signal switches the presently-selected control method (Advanced magnetic flux vector control, Real sensorless vector control, Vector control) to the V/F control. Use this method to switch the control method for one motor. At this time, the second functions including the electronic thermal O/L relay characteristic are not changed. (To switch the second functions, use the RT signal.)

To input the X18 signal, set "18" in any of **Pr.178 to Pr.189 (Input terminal function selection)** to assign the function.

First motor control method	Second motor control method (RT signal-ON)	Pr.450 setting	Pr.453 to Pr.454 settings	Pr.451 setting
V/F control	V/F control	9999	—	—
		—	—	9999
		—	9999 <sup>*2</sup>	—
	Advanced magnetic flux vector control	Induction motor	Other than 9999	20
				10 to 14
	Real sensorless vector control	Induction motor	Other than 9999	0 to 6, 100 to 106
IPM/SPM motor				0, 3, 4, 6
Vector control	IPM/SPM motor	Other than 9999	Other than 9999	
Advanced magnetic flux vector control <sup>*1</sup> Real sensorless vector control <sup>*1</sup> Vector control <sup>*1</sup> PM sensorless vector control	Same control as the first motor <sup>*1</sup>	9999	—	—
	V/F control	—	9999 <sup>*2</sup>	—
	Advanced magnetic flux vector control	Induction motor	Other than 9999	20, 9999
				10 to 14
	Real sensorless vector control	Induction motor	Other than 9999	0 to 6, 100 to 106
				IPM/SPM motor
	Vector control	IPM/SPM motor	Other than 9999	Other than 9999

\*1 V/F control is set by turning ON the X18 signal.

\*2 V/F control when **Pr.453** or **Pr.454** is set to "9999" regardless of the **Pr.451** setting. When **Pr.450** is set to the IPM motor MM-CF, PM sensorless vector control is enabled even if **Pr.453** ≠ "9999" or **Pr.454** = "9999".

## NOTE

- The RT signal is assigned to the terminal RT in the initial status. Set "3" in one of **Pr.178 to Pr.189 (Input terminal function selection)** to assign the RT signal to another terminal.
- The RT signal is a second function selection signal. The RT signal also enables other second functions. (Refer to [page 525](#).)
- The control method could be changed by external terminals (RT signal, X18 signal) while the inverter is stopped. If a signal is switched during the operation, the control method changes after the inverter stops.

## ◆ Switching between two encoder-equipped motors (Pr.862)

- Using the Vector control compatible plug-in options together with the control terminal option (FR-A8TP) enables the Vector control operation by switching between two encoder-equipped motors according to the RT signal. Use **Pr.862 Encoder option selection** to set the combination of the motors (first/second), plug-in option, and control terminal option.

Pr.862 Encoder option selection	RT signal-OFF (First motor)	RT signal-ON (Second motor) <sup>*1</sup>
0 (initial value)	Plug-in option	Control terminal option
1	Control terminal option	Plug-in option

\*1 When **Pr.450 Second applied motor** = "9999", the first motor is selected even if the RT signal turns ON.

## NOTE

- Pr.862** setting is valid even when either the plug-in option or control terminal option is installed. For using the control terminal option alone, the motor does not run when **Pr.862** is the initial value as it is. (When the RT signal is OFF)

## ◆ Changing the control mode with external terminals (MC signal)

- The setting of **Pr.800** or **Pr.451** can be used to switch the control mode by turning ON/OFF the MC signal. Refer to [page 223](#) to set **Pr.800** or **Pr.451**.

To input the MC signal, set "26" in any of **Pr.178 to Pr.189 (Input terminal function selection)** to assign the function.

- When using an analog input terminal (terminal 1, 4) for torque limit and torque command, switching of the control mode changes the terminal function as follows:
- Functions of the terminal 1 under different control modes

Pr.868 setting	Speed control/torque control switchover <sup>*1</sup>		Speed control/position control switchover <sup>*2</sup>		Position control/torque control switchover <sup>*3</sup>	
	Speed control (MC signal-OFF)	Torque control (MC signal-ON)	Speed control (MC signal-OFF)	Position control (MC signal-ON)	Position control (MC signal-OFF)	Torque control (MC signal-ON)
0 (initial value)	Auxiliary speed setting	Speed limit assistance	Auxiliary speed setting	—	—	Speed limit assistance
1	Magnetic flux command <sup>*4</sup>	Magnetic flux command <sup>*4</sup>	Magnetic flux command <sup>*4</sup>	Magnetic flux command <sup>*4</sup>	Magnetic flux command	Magnetic flux command
2	Regenerative torque limit (Pr.810 = "1")	—	Regenerative torque limit (Pr.810 = "1")	Regenerative torque limit (Pr.810 = "1")	Regenerative torque limit (Pr.810 = "1")	—
3	—	Torque command (Pr.804 = "0")	—	—	—	Torque command (Pr.804 = "0")
4	Torque limit (Pr.810 = "1")	Torque command (Pr.804 = "0")	Torque limit (Pr.810 = "1")	Torque limit (Pr.810 = "1")	Torque limit (Pr.810 = "1")	Torque command (Pr.804 = "0")
5	—	Forward/reverse rotation speed limit (Pr.807 = "2")	—	—	—	Forward/reverse rotation speed limit (Pr.807 = "2")
6	—	—	Torque bias	—	—	—
9999	—	—	—	—	—	—

- Terminal 4 functions by control

Pr.858 setting	Speed control/torque control switchover <sup>*1</sup>		Speed control/position control switchover <sup>*2</sup>		Position control/torque control switchover <sup>*3</sup>	
	Speed control (MC signal-OFF)	Torque control (MC signal-ON)	Speed control (MC signal-OFF)	Position control (MC signal-ON)	Position control (MC signal-OFF)	Torque control (MC signal-ON)
0 (initial value)	Speed command (AU signal-ON)	Speed limit (AU signal-ON)	Speed command (AU signal-ON)	—	—	Speed limit (AU signal-ON) <sup>*4</sup>
1	Magnetic flux command <sup>*4*5</sup>	Magnetic flux command <sup>*4*5</sup>	Magnetic flux command <sup>*4*5</sup>	Magnetic flux command <sup>*4*5</sup>	Magnetic flux command <sup>*5</sup>	Magnetic flux command <sup>*5</sup>
4	Torque limit (Pr.810 = "1") <sup>*6</sup>	—	Torque limit (Pr.810 = "1") <sup>*6</sup>	Torque limit (Pr.810 = "1") <sup>*6</sup>	Torque limit (Pr.810 = "1") <sup>*6</sup>	—
9999	—	—	—	—	—	—

—: No function

- \*1 Real sensorless vector control (Pr.800 = "12"), vector control (Pr.800 = "2")
- \*2 Vector control (Pr.800 = "4"), PM sensorless vector control (Pr.800 = "14")
- \*3 Vector control (Pr.800 = "5")
- \*4 This function is valid under vector control.
- \*5 Invalid when Pr.868 = "1".
- \*6 Invalid when Pr.868 = "4".

## NOTE

- Switching between the speed control and the torque control is always enabled regardless of the motor status: in a stop, in running, or in DC injection brake (during pre-excitation).
- During operation, switching between speed control and position control or between torque control and position control occurs when the output frequency reaches **Pr.865 Low speed detection** or lower with no position command given.
- Changing the terminal assignment using **Pr.178 to Pr.189 (Input terminal function selection)** may affect the other functions. Set parameters after confirming the function of each terminal.

## Parameters referred to

- Pr.178 to Pr.189 (Input terminal function selection) [page 521](#)
- Pr.450 Second applied motor [page 528](#)
- Pr.804 Torque command source selection [page 283](#)
- Pr.807 Speed limit selection [page 287](#)
- Pr.810 Torque limit input method selection [page 245](#)
- Pr.858 Terminal 4 function assignment, Pr.868 Terminal 1 function assignment [page 500](#)



## 5.2.3 Selecting the Advanced magnetic flux vector control

Magnetic flux

### Point

- To use the Advanced magnetic flux vector control, set the motor capacity, the number of motor poles, and the motor type using **Pr.80** and **Pr.81**.

## ◆ Advanced magnetic flux vector control

### Operating procedure

1. Perform secure wiring. (Refer to [page 46.](#))
2. Make the motor setting (**Pr.71**).

Motor	Pr.71 setting <sup>*1</sup>	Remarks	
Mitsubishi Electric standard motor Mitsubishi Electric high-efficiency motor	SF-JR	0 (initial value) (3, 4)	
	SF-JR 4P 1.5 kW or lower	20	
	SF-HR	40	
	Others	0 (3)	Offline auto tuning is required. <sup>*2</sup>
Mitsubishi Electric constant-torque motor	SF-JRCA 4P	1	
	SF-HRCA	50	
	Other (SF-JRC, etc.)	1 (13)	Offline auto tuning is required. <sup>*2</sup>
Mitsubishi Electric high-performance energy-saving motor	SF-PR	70	
Other manufacturer's standard motor	—	0 (3)	Offline auto tuning is required. <sup>*2</sup>
Other manufacturer's constant-torque motor	—	1 (13)	Offline auto tuning is required. <sup>*2</sup>

\*1 For the other setting values of **Pr.71**, refer to [page 528](#).

\*2 For offline auto tuning, refer to [page 532](#).

3. Set the motor overheat protection (**Pr.9**). (Refer to [page 415.](#))
4. Set the motor capacity and number of motor poles (**Pr.80**, **Pr.81**). (Refer to [page 221.](#))  
V/F control is performed when the setting is "9999" (initial value).
5. Set the rated motor voltage and frequency (**Pr.83**, **Pr.84**). (Refer to [page 532.](#))
6. Set the operation command. (Refer to [page 389.](#))  
Select the start command and speed command.
7. Perform the test operation.

As required

- Perform the offline auto tuning (**Pr.96**). (Refer to [page 532.](#))
- Select the online auto tuning (**Pr.95**). (Refer to [page 558.](#))

### NOTE

- To perform driving in a better accuracy, perform offline auto tuning, then set the online auto tuning, and select Real sensorless vector control.
- Under this control, rotations are more likely to be uneven than under V/F control. (This control method is not suitable for grinder, wrapping machine, etc., which require even rotation at a low speed.)
- For the FR-A820-03160(55K) or lower and the FR-A840-01800(55K) or lower, the operation with a surge voltage suppression filter (FR-ASF-H/FR-BMF-H) installed between the inverter and the motor may reduce the output torque.
- The optional sine wave filter (MT-BSL/BSC) cannot be used between the inverter and the motor.
- Changing the terminal assignment using **Pr.178 to Pr.189 (Input terminal function selection)** may affect the other functions. Set parameters after confirming the function of each terminal.

## ◆ Keeping the motor speed constant when the load fluctuates (speed control gain)

Pr.	Name	Initial value	Setting range	Description
89 G932	Speed control gain (Advanced magnetic flux vector)	9999	0 to 200%	Makes adjustments to keep the motor speed constant during variable load operation under Advanced magnetic flux vector control. The reference value is 100%.
			9999	The gain set by <b>Pr.71</b> . (The gain set in accordance with the motor.)
569 G942	Second motor speed control gain	9999	0 to 200%	Makes adjustments to keep the second motor speed constant during variable load operation under Advanced magnetic flux vector control. The reference value is 100%.
			9999	The gain set by <b>Pr.450</b> . (The gain set in accordance with the motor.)

- Use **Pr.89** to keep the motor speed constant during variable load operation. (This parameter is useful to make adjustments on the motor speed after replacing a conventional model with an FR-A800 series model.)

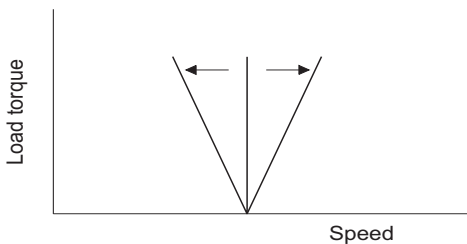

## ◆ Driving two motors under Advanced magnetic flux vector control

- Turning ON the Second function selection (RT) signal enables the second motor operation.
- Set a second motor in **Pr.450 Second applied motor**. (In the initial setting, "9999" (no second applied motor) is selected. Refer to [page 528](#).)

Function	RT signal-ON (second motor)	RT signal-OFF (first motor)
Applied motor	<b>Pr.450</b>	<b>Pr.71</b>
Motor capacity	<b>Pr.453</b>	<b>Pr.80</b>
Number of motor poles	<b>Pr.454</b>	<b>Pr.81</b>
Speed control gain (Advanced magnetic flux vector)	<b>Pr.569</b>	<b>Pr.89</b>
Control method selection	<b>Pr.451</b>	<b>Pr.800</b>

### NOTE

- The RT signal is a Second function selection signal. The RT signal also enables other second functions. (Refer to [page 525](#).) The RT signal is assigned to the terminal RT in the initial status. Set "3" in one of **Pr.178 to Pr.189 (Input terminal function selection)** to assign the RT signal to another terminal.
- Changing the terminal assignment using **Pr.178 to Pr.189 (Input terminal function selection)** may affect the other functions. Set parameters after confirming the function of each terminal.

### Parameters referred to

**Pr.71, Pr.450 Applied motor** [page 528](#)  
**Pr.800, Pr.451 Control method selection** [page 221](#)

## 5.2.4 Selecting the PM sensorless vector control

### PM

#### ◆ Setting for the PM sensorless vector control by selecting IPM initialization on the operation panel



("I PM")

#### Point

- The parameters required to drive an IPM motor MM-CF are automatically set by batch. (Refer to [page 231](#).)
- [PM] indicator on the operation panel (FR-DU08) is turned ON when the PM sensorless vector control is set.

The following shows the procedure to initialize the parameter settings for an MM-CF IPM motor by selecting IPM parameter initialization on the operation panel.

#### Operating procedure

- 1.** Turning ON the power of the inverter  
The operation panel is in the monitor mode.
- 2.** Changing the operation mode  
Press   to choose the PU operation mode.  
[PU] indicator turns ON.
- 3.** Selecting the parameter setting mode  
Press  to choose the parameter setting mode.  
[PRM] indicator is ON.
- 4.** IPM initialization selection  
Turn  until "I PM" (IPM initialization) appears.
- 5.** Displaying the set value  
Press  to read the present set value.  
"0" (initial value) appears.
- 6.** Changing the setting value  
Turn  to change the value to "3003", and press  to confirm it.  
"3003" and "I PM" are displayed alternately. The setting is completed.

Setting	Description
0	Parameter settings for an induction motor
3003	Parameter settings for MM-CF IPM motor (rotations per minute)

#### NOTE

- If parameters are initialized for a PM motor in the IPM initialization mode, the **Pr.998 PM parameter initialization** setting is automatically changed.
- In the initial parameter setting, the capacity same as the inverter capacity is set in **Pr.80 Motor capacity**. To use a motor capacity that is one rank lower than the inverter capacity, set **Pr.80 Motor capacity** by selecting the mode on the operation panel.
- To set a speed by adjusting frequencies or to monitor it, use **Pr.998**. (Refer to [page 231](#).)

## ◆ Initializing the parameters required for the PM sensorless vector control (Pr.998)

- PM parameter initialization sets parameters required for driving an IPM motor MM-CF.
- The offline auto tuning enables the operation with an IPM motor other than MM-CF and with SPM motors.
- Two MM-CF PM parameter initialization methods are available; setting **Pr.998 PM parameter initialization**, and selecting IPM initialization ("PM") on the operation panel.

Pr.	Name	Initial value	Setting range	Description	
998 E430	PM parameter initialization	0	0	Parameter setting (in frequencies) for an induction motor	The setting of the motor parameters is changed to the setting required to drive an induction motor.
			3003	Parameter setting (in rotations per minute) for the MM-CF IPM motor	The setting of the motor parameters is changed to the setting required to drive an IPM motor.
			3103	Parameter setting (in frequencies) for the MM-CF IPM motor	
			8009	Parameter setting (in rotations per minute) for an IPM motor other than MM-CF (after tuning)	The setting of the motor parameters is changed to the setting required to drive an IPM motor. (Set <b>Pr.71 Applied motor</b> and perform offline auto tuning in advance. (Refer to <a href="#">page 551</a> .)
			8109	Parameter setting (in frequencies) for an IPM motor other than the MM-CF (after tuning)	
			9009	Parameter setting (in rotations per minute) for an SPM motor (after tuning)	The setting of the motor parameters is changed to the setting required to drive an SPM motor. (Set <b>Pr.71 Applied motor</b> and perform offline auto tuning in advance. (Refer to <a href="#">page 551</a> .)
			9109	Parameter setting (in frequencies) for an SPM motor (after tuning)	

- To use a motor capacity that is one rank lower than the inverter capacity, set **Pr.80 Motor capacity** before performing PM parameter initialization.
- When **Pr.998** = "3003, 8009, or 9009", the monitor is displayed and the frequency is set using the motor rotations per minute. To use frequency to display or set, set **Pr.998** = "3103, 8109, or 9109".
- Set **Pr.998** = "0" to change the PM sensorless vector control parameter settings to the parameter settings required to drive an induction motor.
- When using an IPM motor or SPM motor other than MM-CF, set **Pr.998** = "8009, 8109, 9009, or 9109".

### NOTE

- Make sure to set **Pr.998** before setting other parameters. If the **Pr.998** setting is changed after setting other parameters, some of those parameters are initialized too. (Refer to the "List of the target parameters for the motor parameter initialization".)
- To change back to the parameter settings required to drive an induction motor, perform Parameter clear or All parameter clear.
- If the setting of **Pr.998 PM parameter initialization** is changed between "3003, 8009, 9009 (rotations per minute)" ↔ "3103, 8109, 9109 (frequency)", the target parameters are respectively set to their initial values.  
The purpose of Pr.998 is not to change the display units. Use **Pr.144 Speed setting switchover** to change the display units between rotations per minute and frequency. Using **Pr.144** enables switching the unit between rotations per minute and frequencies without initializing the setting of the motor parameters.  
Example) Changing the **Pr.144** setting between "6" and "106" switches the display units between frequency and rotations per minute.
- For an inverter out of the capacity range of the IPM motor MM-CF, "3003 or 3103" cannot be set. (Refer to [page 833](#) for the capacities of MM-CF motors.)
- The PM parameter initialization (**Pr.998**) changes parameter settings for the first motor. When a PM motor is used as the second motor, parameters for the second motor must be set individually.

## ◆ List of the target parameters for the motor parameter initialization

- The parameter settings in the following table are changed to the settings required to perform PM sensorless vector control by selecting the IPM initialization on the operation panel or by using **Pr.998 PM parameter initialization**. The changed settings differ according to the specification (capacity) of the PM motor used.

- Performing Parameter clear or All parameter clear resets these parameter settings to the settings required to drive an induction motor.

Pr.	Name	Setting						Setting increments	
		Induction motor		PM motor (setting in rotations per minute)		PM motor (setting in frequencies)			
		0 (initial value)		3003 (MM-CF)	8009 9009 (other than MM-CF)	3103 (MM-CF)	8109 9109 (other than MM-CF)	3003, 8009, 9009	0, 3003, 8109, 9109
FM	CA								
1	Maximum frequency	120 Hz <sup>*1</sup>		3000 r/min	Maximum motor rotations per minute <sup>*8</sup>	200 Hz	Maximum motor frequency <sup>*8</sup>	1 r/min	0.01 Hz
		60 Hz <sup>*2</sup>							
4	Multi-speed setting (high speed)	60 Hz	50 Hz	2000 r/min	Pr.84	133.33 Hz	Pr.84	1 r/min	0.01 Hz
9	Electronic thermal O/L relay	Inverter rated current		Rated motor current <sup>*10</sup>	—	Rated motor current <sup>*10</sup>	—	0.01 A <sup>*1</sup>	
								0.1 A <sup>*2</sup>	
13	Starting frequency	0.5 Hz		8 r/min <sup>*5</sup>	Pr.84 × 10%	0.5 Hz <sup>*6</sup>	Pr.84 × 10%	1 r/min	0.01 Hz
15	Jog frequency	5 Hz		200 r/min	Pr.84 × 10%	13.33 Hz	Pr.84 × 10%	1 r/min	0.01 Hz
18	High speed maximum frequency	120 Hz <sup>*1</sup>		3000 r/min	—	200 Hz	—	1 r/min	0.01 Hz
		60 Hz <sup>*2</sup>							
20	Acceleration/deceleration reference frequency	60 Hz	50 Hz	2000 r/min	Pr.84	133.33 Hz	Pr.84	1 r/min	0.01 Hz
22	Stall prevention operation level	150% <sup>*7</sup>		150% <sup>*7</sup>				0.1%	
37	Speed display	0		0				1	
55	Frequency monitoring reference	60 Hz	50 Hz	2000 r/min	Pr.84	133.33 Hz	Pr.84	1 r/min	0.01 Hz
56	Current monitoring reference	Inverter rated current		Rated motor current <sup>*10</sup>	Pr.859	Rated motor current <sup>*10</sup>	Pr.859	0.01 A <sup>*1</sup>	
								0.1 A <sup>*2</sup>	
71	Applied motor	0		330 <sup>*3</sup>	—	330 <sup>*3</sup>	—	1	
80	Motor capacity	9999		Motor capacity (MM-CF) <sup>*4</sup>	—	Motor capacity (MM-CF) <sup>*4</sup>	—	0.01 kW <sup>*1</sup>	
								0.1 kW <sup>*2</sup>	
81	Number of motor poles	9999		8 <sup>*4</sup>	—	8 <sup>*4</sup>	—	1	
84	Rated motor frequency	9999		2000 r/min	—	133.33 Hz	—	1 r/min	0.01 Hz
116	Third output frequency detection	60 Hz	50 Hz	2000 r/min	Pr.84	133.33 Hz	Pr.84	1 r/min	0.01 Hz
125 (903)	Terminal 2 frequency setting gain frequency	60 Hz	50 Hz	2000 r/min	Pr.84	133.33 Hz	Pr.84	1 r/min	0.01 Hz
126 (905)	Terminal 4 frequency setting gain frequency	60 Hz	50 Hz	2000 r/min	Pr.84	133.33 Hz	Pr.84	1 r/min	0.01 Hz
144	Speed setting switchover	4		108	Pr.81 +100	8	Pr.81	1	
240	Soft-PWM operation selection	1		0				1	
263	Subtraction starting frequency	60 Hz	50 Hz	2000 r/min	Pr.84	133.33 Hz	Pr.84	1 r/min	0.01 Hz
266	Power failure deceleration time switchover frequency	60 Hz	50 Hz	2000 r/min	Pr.84	133.33 Hz	Pr.84	1 r/min	0.01 Hz
374	Overspeed detection level	9999		3150 r/min	Maximum motor rotations per minute + 10 Hz <sup>*8*9</sup>	210 Hz	Maximum motor frequency + 10 Hz <sup>*8</sup>	1 r/min	0.01 Hz
386	Frequency for maximum input pulse	60 Hz	50 Hz	2000 r/min	Pr.84	133.33 Hz	Pr.84	1 r/min	0.01 Hz
505	Speed setting reference	60 Hz	50 Hz	133.33 Hz	Pr.84	133.33 Hz	Pr.84	0.01 Hz	

Pr.	Name	Setting						Setting increments	
		Induction motor		PM motor (setting in rotations per minute)		PM motor (setting in frequencies)		3003, 8009, 9009	0, 3003, 8109, 9109
		0 (initial value)		3003 (MM-CF)	8009 9009 (other than MM-CF)	3103 (MM-CF)	8109 9109 (other than MM-CF)		
FM	CA								
557	Current average value monitor signal output reference current	Inverter rated current		Rated motor current <sup>*10</sup>	Pr.859	Rated motor current <sup>*10</sup>	Pr.859	0.01 A <sup>*1</sup>	0.1 A <sup>*2</sup>
820	Speed control P gain 1	60%		30%				1%	
821	Speed control integral time 1	0.333 s		0.333 s				0.001 s	
824	Torque control P gain 1 (current loop proportional gain)	100%		100%				1%	
825	Torque control integral time 1 (current loop integral time)	5 ms		20 ms				0.1 ms	
870	Speed detection hysteresis	0 Hz		8 r/min	0.5 Hz <sup>*9</sup>	0.5 Hz		1 r/min	0.01 Hz
885	Regeneration avoidance compensation frequency limit value	6 Hz		200 r/min	Pr.84 × 10%	13.33 Hz	Pr.84 × 10%	1 r/min	0.01 Hz
893	Energy saving monitor reference (motor capacity)	Inverter rated current		Motor capacity (Pr.80)				0.01 kW <sup>*1</sup>	0.1 kW <sup>*2</sup>
C14 (918)	Terminal 1 gain frequency (speed)	60 Hz	50 Hz	2000 r/min	Pr.84	133.33 Hz	Pr.84	1 r/min	0.01 Hz
1121	Per-unit speed control reference frequency	120 Hz <sup>*1</sup>		3000 r/min	Maximum motor rotations per minute <sup>*8</sup>	200 Hz	Maximum motor frequency <sup>*8</sup>	1 r/min	0.01 Hz
		60 Hz <sup>*2</sup>							

—: Not changed

\*1 Initial value for the FR-A820-03160(55K) or lower and FR-A840-01800(55K) or lower.

\*2 Initial value for the FR-A820-03800(75K) or higher and FR-A840-02160(75K) and higher.

\*3 When Pr.71 Applied motor = "333, 334, 8093, 8094, 9093, or 9094", the Pr.71 setting is not changed.

\*4 When a value other than "9999" is set, the set value is not changed.

\*5 200 r/min when Pr.788 Low speed range torque characteristic selection = "0".

\*6 13.33 Hz when Pr.788 Low speed range torque characteristic selection = "0".

\*7 110% for SLD, 120% for LD, 150% for ND, and 200% for HD (Refer to Pr.570 Multiple rating setting on page 343.)

\*8 The Pr.702 Maximum motor frequency is used as the maximum motor frequency (rotations per minute). When Pr.702 = "9999 (initial value)", the Pr.84 Rated motor frequency is used as the maximum motor frequency (rotations per minute).

\*9 The setting value is converted from frequency to rotations per minute. (It differs according to the number of motor poles.)

\*10 Refer to page 833 for the rated motor current of MM-CF.

## NOTE

- If IPM parameter initialization is performed in rotations per minute (Pr.998 = "3003, 8009, or 9009"), the parameters not listed in the table and the monitor items are also set and displayed in rotations per minute.

## 5.2.5 Low-speed range torque characteristics

### PM

The torque characteristics in a low-speed range under PM sensorless vector control can be changed.

Pr.	Name	Initial value	Setting range	Operation
788 G250	Low speed range torque characteristic selection	9999	0	Disables the low-speed range torque characteristic (current synchronization operation).
			9999 <sup>*1</sup>	Enables the low-speed range torque characteristic (high frequency superposition control)
747 G350	Second motor low-speed range torque characteristic selection	9999	0	Disables the low-speed range torque characteristic (current synchronization operation) while the RT signal is ON.
			9999 <sup>*1</sup>	Enables the low-speed range torque characteristic (high frequency superposition control) while the RT signal is ON.

\*1 The low-speed range high-torque characteristic (current synchronization operation) is disabled for PM motors other than MM-CF, even if "9999" is set.

### ◆ When the low-speed range torque characteristic is enabled (Pr.788 = "9999 (initial value)")

- The high frequency superposition control provides enough torque in the low-speed range operation.
- The low-speed range high-torque characteristic is only valid with an MM-CF motor.

### ◆ When the low-speed range high-torque characteristic is disabled (Pr.788 = "0")

- The current synchronization operation reduces much motor noise compared with the high frequency superposition control.
- Since the torque in a low-speed range is low, use this setting for an operation with light start-up load.

### ◆ Low-speed range high-torque characteristic is set for the second motor (Pr.747)

- Use **Pr.747 Second motor low-speed range torque characteristic selection** to switch the torque characteristic in a low-speed range according to the application or to switch among motors connected to one inverter.
- The **Pr.747** becomes valid when the RT signal turns ON.

#### NOTE

- Position control under PM sensorless vector control is not available when the current synchronization operation is selected. Zero speed and servo lock are also disabled during current synchronization operation.
- For torque characteristics, refer to [page 833](#).
- The RT signal is assigned to the terminal RT in the initial status. Set "3" in one of **Pr.178 to Pr.189 (Input terminal function selection)** to assign the RT signal to another terminal.
- Changing the terminal assignment using **Pr.178 to Pr.189 (Input terminal function selection)** may affect the other functions. Set parameters after confirming the function of each terminal.

#### Parameters referred to

**Pr.178 to Pr.189 (Input terminal function selection)**  [page 521](#)

## 5.3 Speed control under Real sensorless vector control, vector control, PM sensorless vector control

Purpose	Parameter to set		Refer to page
To limit the torque during speed control	Torque limit	P.H500, P.H700 to P.H704, P.H710, P.H720, P.H721, P.H730, P.T010, P.T040, P.G210	Pr.22, Pr.801, Pr.803, Pr.810, Pr.812 to Pr.817, Pr.858, Pr.868, Pr.874 245
To adjust the speed control gain	Easy gain tuning gain adjustment	P.C112 to P.C114, P.G206, P.G211, P.G212, P.G218, P.G260, P.G261, P.G311, P.G312, P.G361	Pr.818 to Pr.821, Pr.830, Pr.831, Pr.880, Pr.1115 to Pr.1118, Pr.1121 254
To improve the motor trackability for the speed command changes	Speed feed forward control, model adaptive speed control	P.G220 to P.G224, P.G262, P.C114	Pr.828, Pr.877 to Pr.881, Pr.1119 263
To stabilize the speed detection signal	Speed detection filter	P.G215, P.G315	Pr.823, Pr.833 332
To make starting torque start-up faster	Torque bias	P.G230 to P.G238	Pr.840 to Pr.848 265
To avoid motor overrunning	Speed deviation excess, speed limit, deceleration check	P.H415 to P.H417, P.H881	Pr.285, Pr.690, Pr.853, Pr.873 269
To avoid mechanical resonance	Notch filter	P.G601 to P.G603	Pr.1003 to Pr.1005 271
To adjust the gain during PM sensorless vector control	Speed control gain adjustment	P.G211, P.G212	Pr.820, Pr.821 254

Speed control performs control so that the speed command and the actual motor rotation speed match.



## ◆ Control block diagram

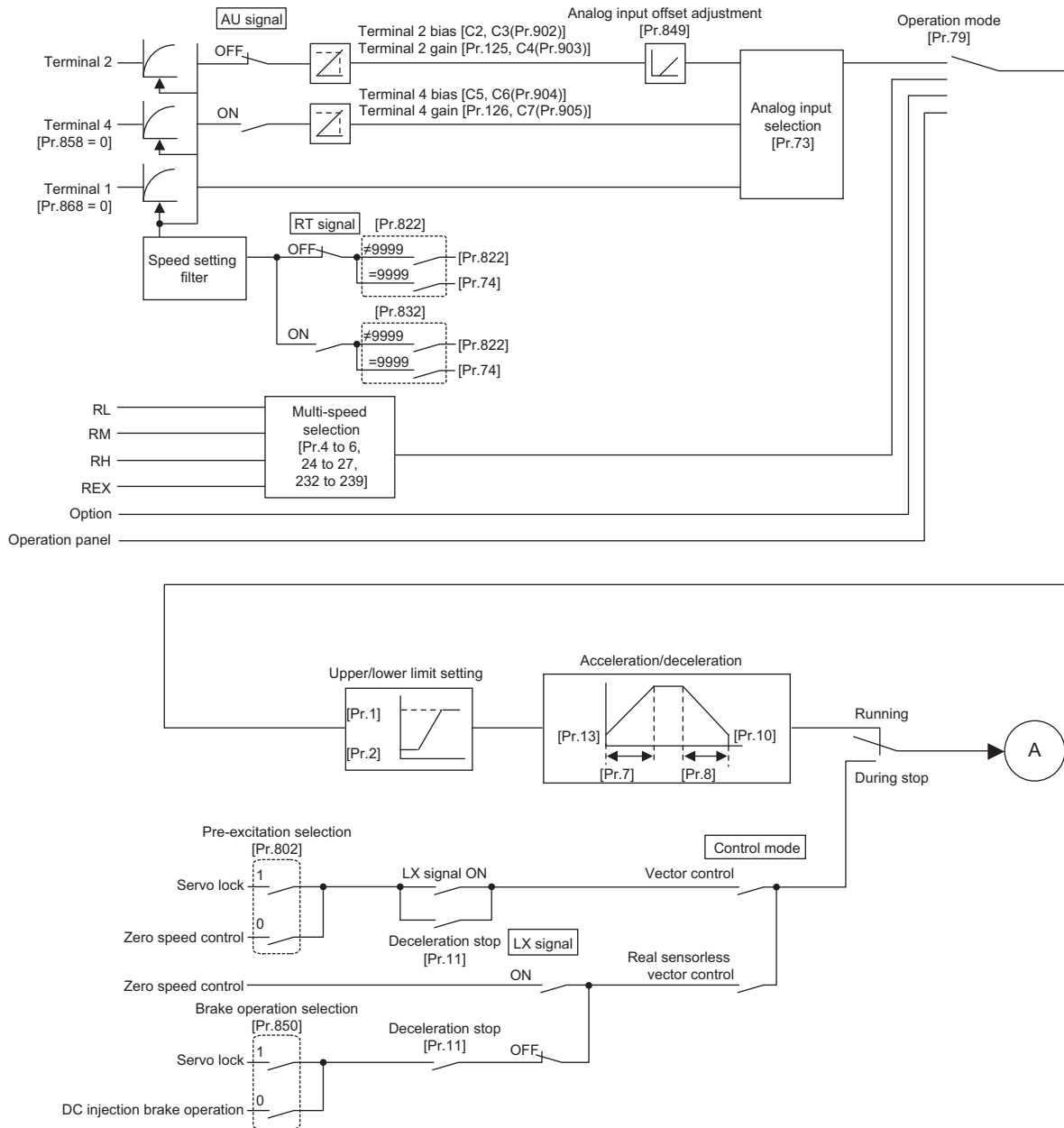

### NOTE

- The RT (Second function selection) signal and the X9 (Third function selection) signal are used to enable switching between acceleration/deceleration time settings. The acceleration/deceleration time after switching depends on the settings in **Pr.44 Second acceleration/deceleration time** and **Pr.45 Second deceleration time**, or **Pr.110 Third acceleration/deceleration time** and **Pr.111 Third deceleration time**. The acceleration/deceleration time is a period of time taken to reach **Pr.20 Acceleration/deceleration reference frequency**.
- **Pr.21 Acceleration/deceleration time increments** is used to change the setting increment.
- When the automatic restart after instantaneous power failure is selected, the inverter accelerates the motor from the frequency search result frequency to the set frequency. (**Pr.57 Restart coasting time** ≠ 9999, **Pr.162 Automatic restart after instantaneous power failure selection** = "10, 12, 13, 1010, 1012, or 1013")
- **Pr.811 Set resolution switchover** is used to change the setting increment for speed setting, operation speed monitoring, and torque limit setting.
- **Pr.862 Encoder option selection** is used to change the Vector control compatible plug-in option or the control terminal option for the first and second motors.
- To avoid overdriving the motor due to incorrect encoder pulse settings, the output frequency can be limited with the set frequency plus the value set in **Pr.873 Speed limit**.

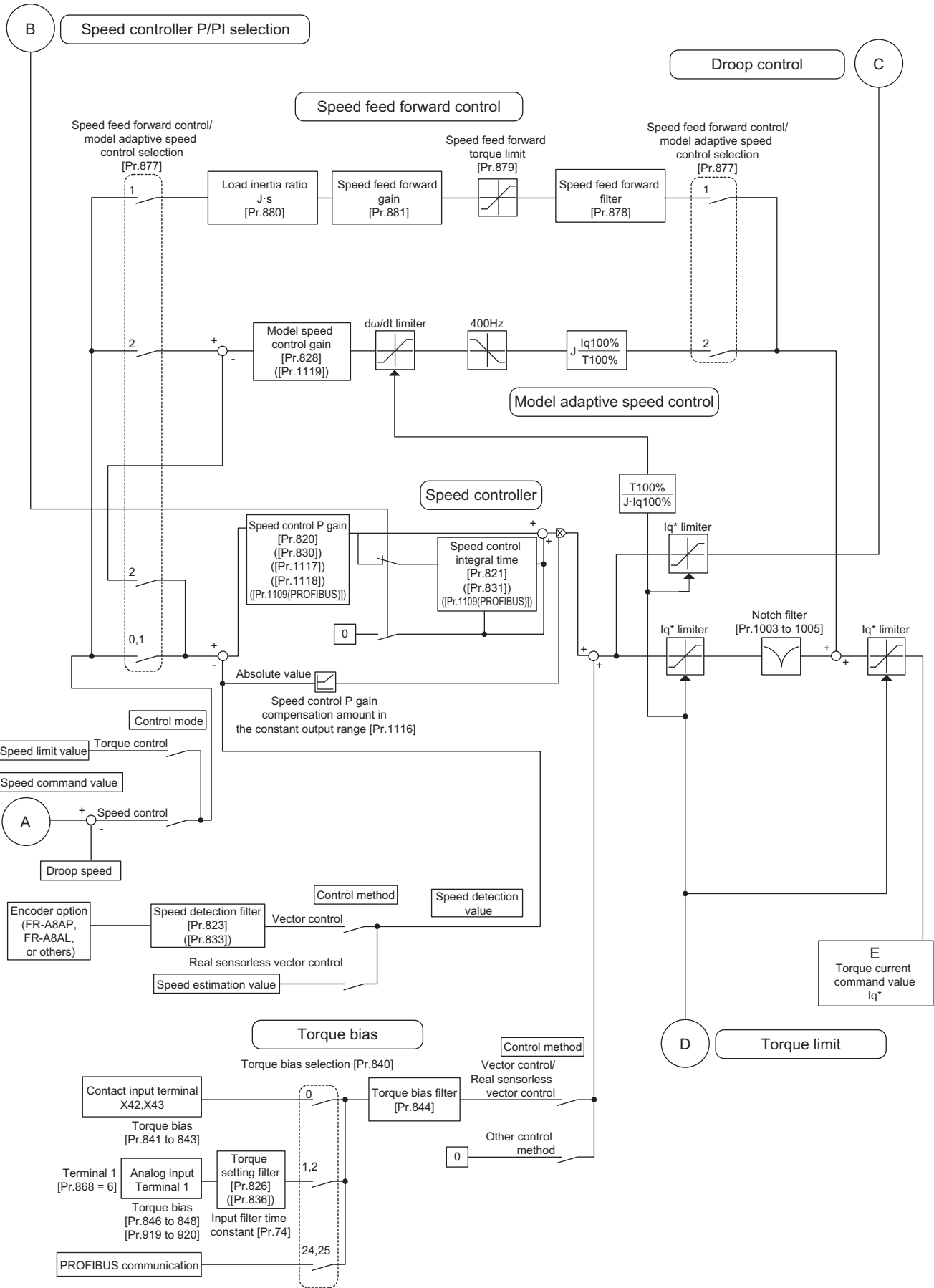

## Speed controller P/PI selection

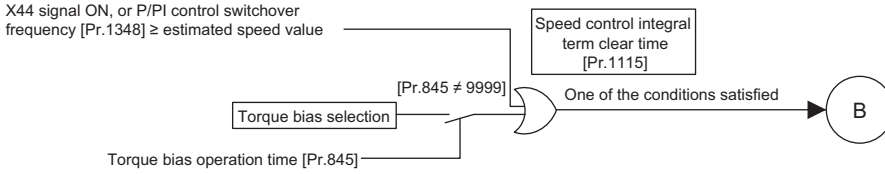

## Droop control

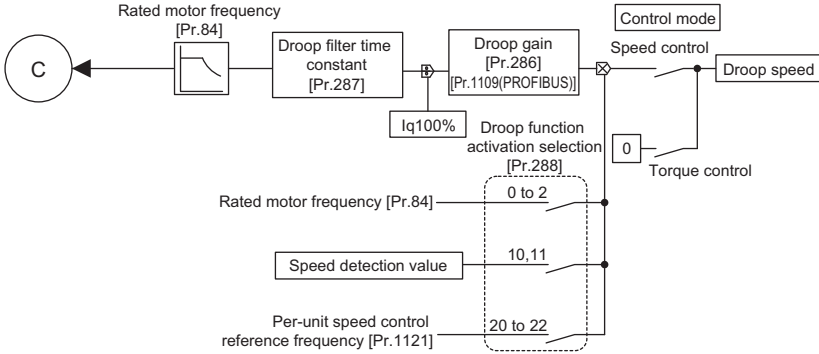

## Constant output range torque characteristic selection

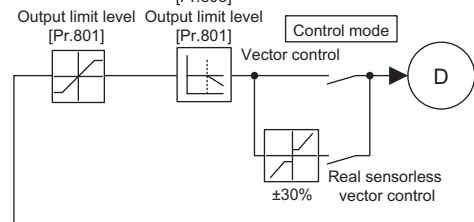

## Torque limit

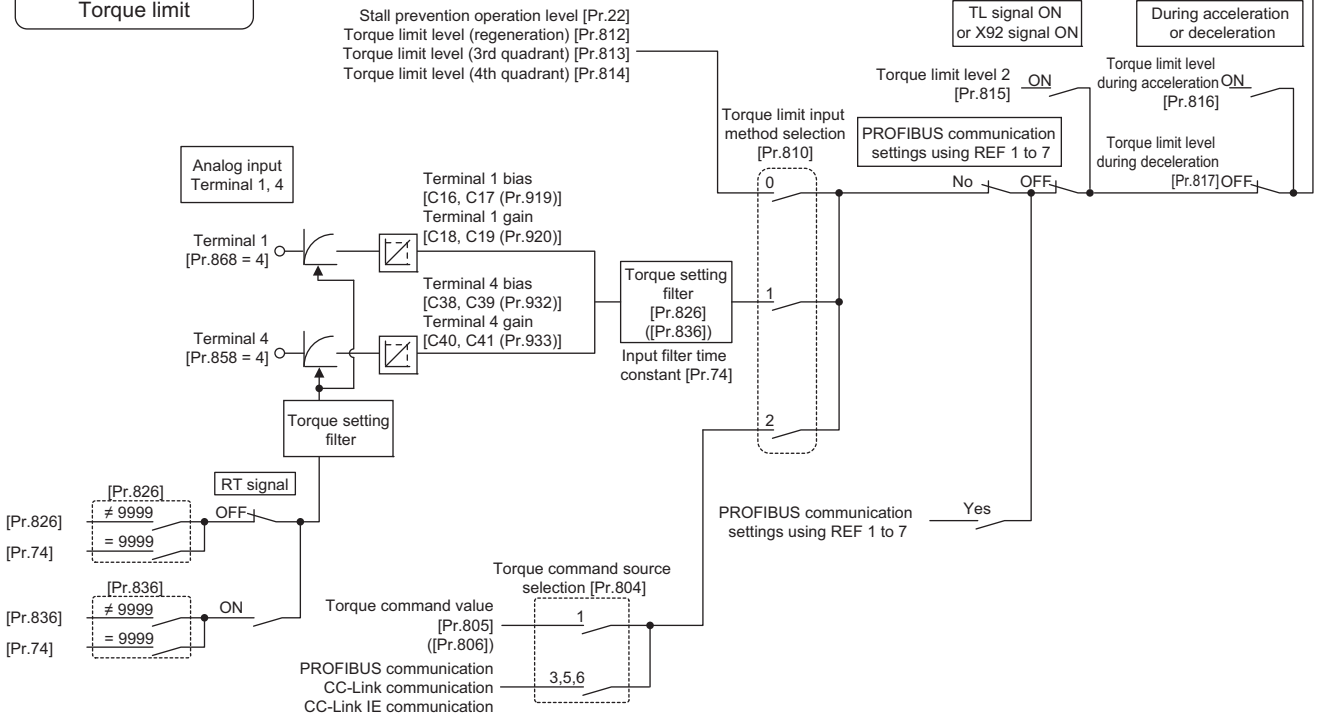

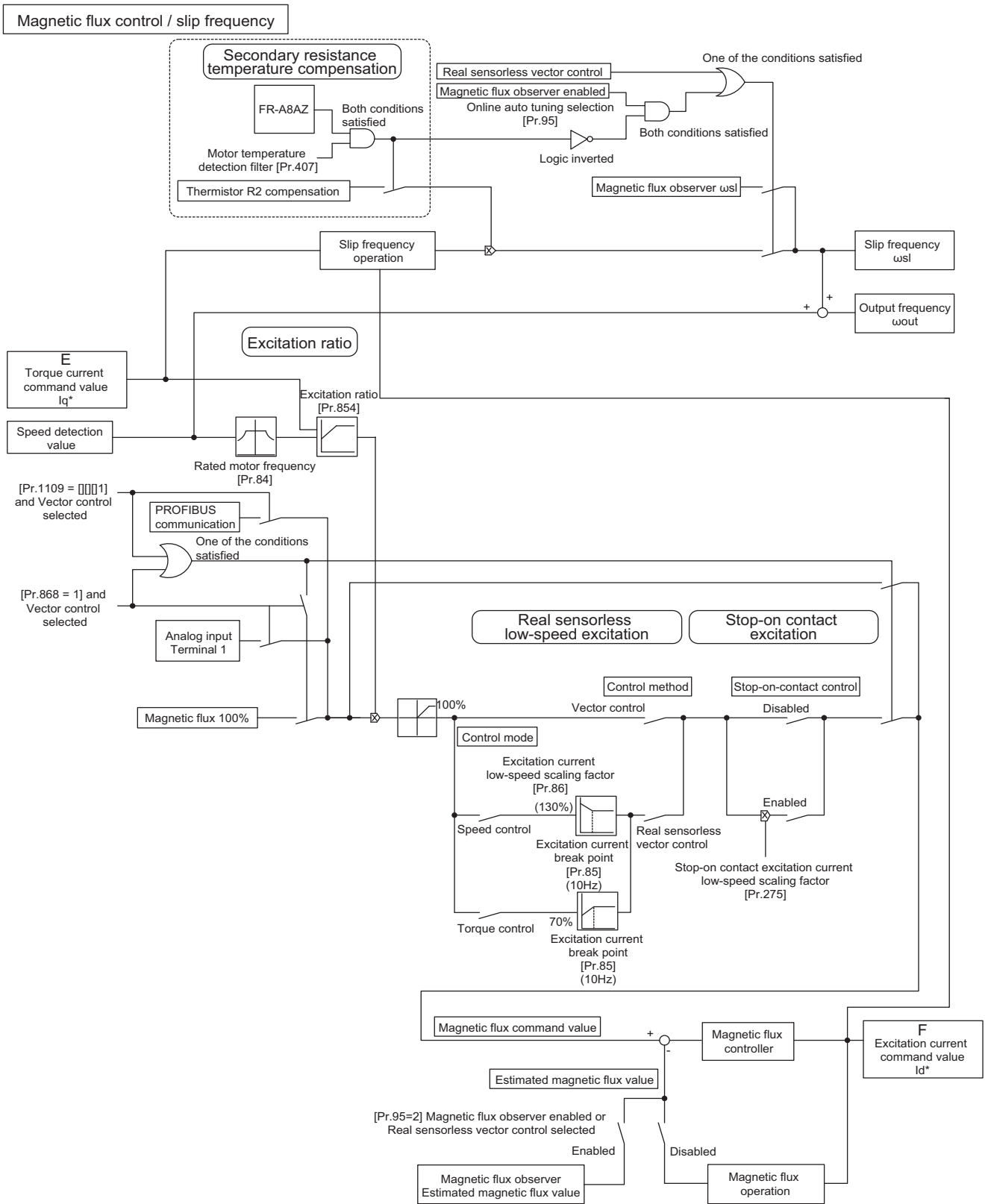

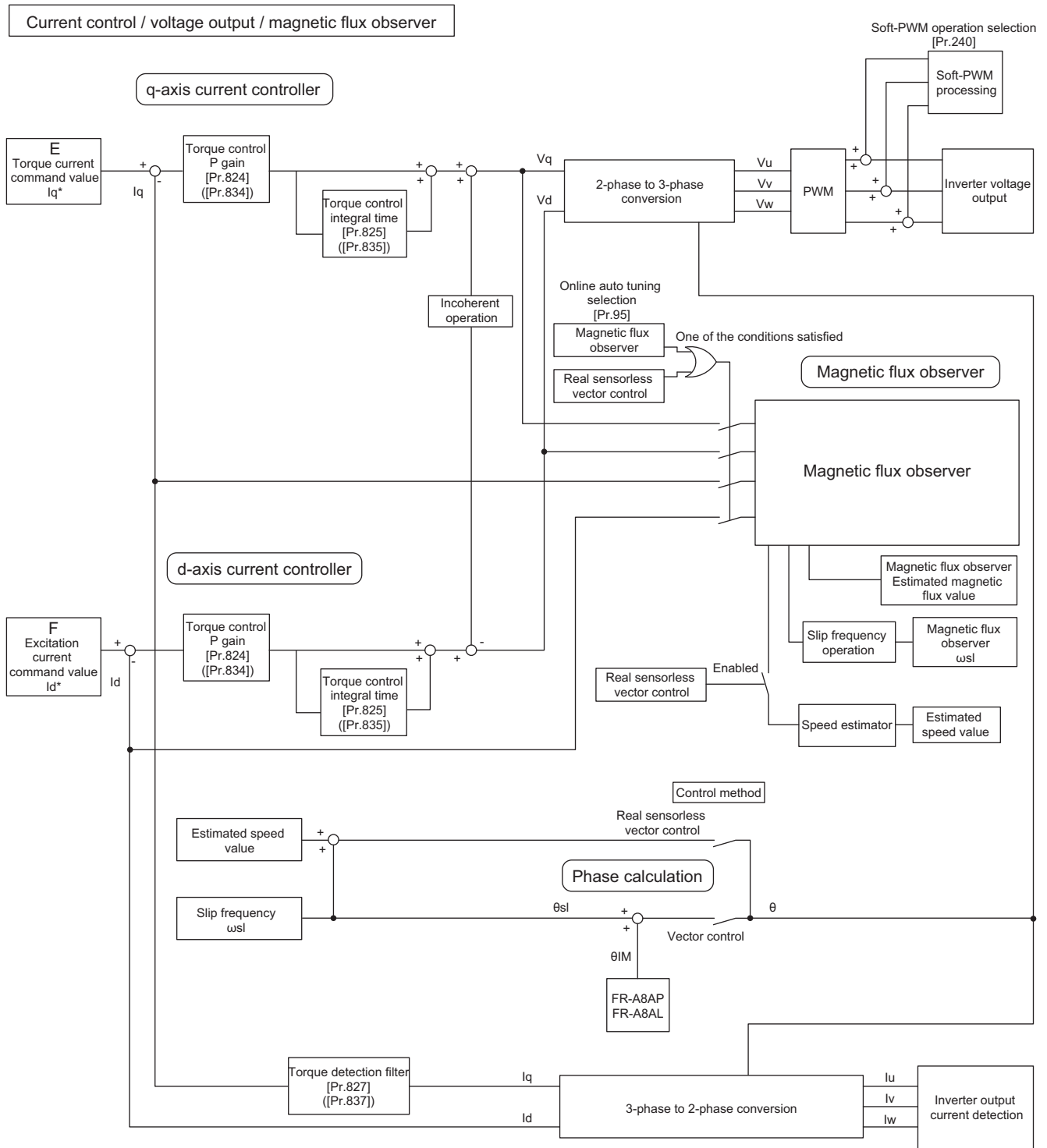

## 5.3.1 Setting procedure of Real sensorless vector control (speed control)

**Sensorless**

### Operating procedure

1. Perform secure wiring. (Refer to [page 46.](#))
2. Set the motor (**Pr.71**). (Refer to [page 528.](#))  
Set **Pr.71 Applied motor** to "0" (standard motor) or "1" (constant-torque motor).
3. Set the overheat protection of the motor (**Pr.9**). (Refer to [page 415.](#))

4. Set the motor capacity and number of motor poles (**Pr.80** and Pr.81). (Refer to [page 221](#).)  
V/F control is performed when the setting is "9999" (initial value).
5. Set the rated motor voltage and the rated motor frequency (**Pr.83** and Pr.84). (Refer to [page 532](#).)
6. Select the control method (**Pr.800**). (Refer to [page 221](#).)  
Select **Pr.800** = "10" (speed control) or "12" (speed/torque switchover) to enable speed control.
7. Set the operation command. (Refer to [page 389](#).)  
Select the start command and speed command.
8. Set the torque limit (**Pr.810**). (Refer to [page 245](#).)
9. Perform the offline auto tuning (**Pr.96**) (Refer to [page 532](#).)
10. Perform the test operation.

As required

- Select online auto tuning (**Pr.95**) (Refer to [page 558](#).)
- Perform easy gain tuning. (Refer to [page 256](#).)
- Adjust the speed control gain manually. (Refer to [page 257](#).)

#### NOTE

- During Real sensorless vector control, offline auto tuning must be performed properly before starting operations.
- The speed command setting range under Real sensorless vector control is 0 to 400 Hz.
- The carrier frequency is limited during Real sensorless vector control. (Refer to [page 356](#).)
- Torque control is not available in a low-speed (about 10 Hz or lower) regenerative range, or with a low speed and light load (about 5 Hz or lower and rated torque about 20% or lower). Vector control must be selected.
- Performing pre-excitation (LX signal and X13 signal) under torque control may start the motor running at a low speed even when the start signal (STF or STR) is not input. The inverter at a start command ON may also rotate the motor at a low speed even though a speed limit value is set to zero. Therefore, confirm that the motor running does not cause any safety problem before performing pre-excitation.
- Switching between the forward rotation command (STF) and reverse rotation command (STR) must not be performed during operations under torque control. An overcurrent trip (E.OC[]) or opposite rotation deceleration fault (E.11) will occur.
- When performing continuous operations under Real sensorless vector control in the FR-A820-00250(3.7K) or lower or FR-A840-00126(3.7K) or lower, the speed fluctuation increases when the value is 20 Hz or less, and in the low-speed range of less than 1 Hz, there may be torque shortage. In such case, stop the inverter and restart it to improve the situation.
- In case of starting the motor while the motor is coasting under Real sensorless vector control, the frequency search must be set for the automatic restart after instantaneous power failure function (**Pr.57** ≠ "9999", **Pr.162** = "10"). (Refer to [page 628](#).)
- When Real sensorless vector control is applied, there may not be enough torque provided in the ultra low-speed range of about 2 Hz or lower.

Generally, the speed control range is as follows.

For power driving, 1:200 (2, 4 or 6 poles) (available at 0.3 Hz or higher when the rating is 60 Hz), 1:30 (8 poles or more) (available at 2 Hz or higher when the rating is 60 Hz).

For regenerative driving, 1:12 (2 to 10 poles) (available at 5 Hz or higher when the rating is 60 Hz).

## 5.3.2 Setting procedure of Vector control (speed control)

### Vector

#### ◆ Using an induction motor

##### Operating procedure

1. Perform secure wiring. (Refer to [page 91](#).)  
Install a Vector control compatible option.
2. Set the option to be used (**Pr.862**).  
Set **Pr.862 Encoder option selection** according to the option to be used. (Refer to [page 226](#).)
3. Set the applied motor and encoder (**Pr.71**, **Pr.359 (Pr.852)**, and **Pr.369 (Pr.851)**). (Refer to [page 94](#).)
4. Set the overheat protection of the motor (**Pr.9**). (Refer to [page 415](#).)  
When using the SF-V5RU or a motor equipped with a thermal sensor, set **Pr.9** = 0 A.
5. Set the motor capacity and number of motor poles (**Pr.80** and Pr.81). (Refer to [page 221](#).)  
V/F control is performed when the setting is "9999" (initial value).
6. Set the rated motor voltage and the rated motor frequency (**Pr.83** and Pr.84). (Refer to [page 532](#).)
7. Select the control method (**Pr.800**). (Refer to [page 221](#).)  
Select **Pr.800** = "0" (speed control), "2" (speed/torque switchover), or "4" (speed/position switchover) to enable speed control.
8. Set the operation command. (Refer to [page 389](#).)  
Select the start command and speed command.
9. Set the torque limit (**Pr.810**). (Refer to [page 245](#).)
10. Perform the test operation.

As required

- Perform offline auto tuning (**Pr.96**) (Refer to [page 532](#))
- Select online auto tuning (**Pr.95**) (Refer to [page 558](#).)
- Perform easy gain tuning. (Refer to [page 256](#).)
- Adjust the speed control gain manually. (Refer to [page 257](#).)

#### NOTE

- The speed command setting range under Vector control is 0 to 400 Hz.
- The carrier frequency is limited during Vector control. (Refer to [page 356](#).)
- Refer to the Instruction Manual of each option for details on Vector control using the FR-A8APR, FR-A8APS, or FR-A8APA.

## ◆ Using a PM motor

### Operating procedure

1. Set the applied encoder (**Pr.359 (Pr.852), Pr.369 (Pr.851)**).  
Refer to [page 94](#) and set the parameters according to the option and the encoder to be used.
2. Set the applied motor (**Pr.9, Pr.71, Pr.80, Pr.81, Pr.83, Pr.84**).  
Set **Pr.71 Applied motor, Pr.9 Rated motor current, Pr.80 Motor capacity, Pr.81 Number of motor poles, Pr.83 Rated motor voltage, and Pr.84 Rated motor frequency** according to the motor specifications. (Setting "9999 (initial value)" in **Pr.80 or Pr.81** selects V/F control.) Set **Pr.702, Pr.706, Pr.707, Pr.724 and Pr.725** as required.
3. Select Vector control (speed control). (Refer to [page 221](#).)
4. Perform offline auto tuning and encoder position tuning (**Pr.96**). (Refer to [page 542](#).)  
Set **Pr.96**, and perform tuning.
5. Configure the initial parameter setting for the applied motor using **Pr.998**.  
When the setting for the PM motor is selected in **Pr.998 PM parameter initialization**, Vector control for the PM motor with an encoder is enabled.  
"8009": Parameter (rotations per minute) settings for an IPM motor other than MM-CF  
"8109": Parameter (frequency) settings for an IPM motor other than MM-CF  
"9009": Parameter (rotations per minute) settings for an SPM motor  
"9109": Parameter (frequency) settings for an SPM motor
6. Perform the test operation.

#### NOTE

- For PM motors, after performing offline auto tuning and encoder position tuning, first perform PM parameter initialization. If parameter initialization is performed after setting other parameters, some of those parameters are initialized too. (Refer to [page 231](#) for the parameters that are initialized.)



## 5.3.3 Setting procedure of PM sensorless vector control (speed control)

### PM

This inverter is set for a general-purpose motor in the initial setting. Follow the following procedure to change the setting for the PM sensorless vector control.

### ◆ Driving an MM-CF IPM motor

#### Operating procedure

1. Perform IPM parameter initialization. (Refer to [page 230](#).)  
Set "3003 or 3103" in **Pr.998 PM parameter initialization**, or select "3003" in "PM" (IPM initialization).

setting	Description
3003	Parameter settings for MM-CF IPM motor (rotations per minute)
3103	Parameter settings for MM-CF IPM motor (frequencies)

2. Set parameters such as the acceleration/deceleration time and multi-speed setting.  
Set parameters such as the acceleration/deceleration time and multi-speed setting as required.
3. Set the operation command. (Refer to [page 389](#).)  
Select the start command and speed command.
4. Perform the test operation.

As required

- Perform offline auto tuning for a PM motor. (Refer to [page 551](#).)

#### NOTE

- To change to the PM sensorless vector control, perform PM parameter initialization at first. If parameter initialization is performed after setting other parameters, some of those parameters are initialized too. (Refer to [page 231](#) for the parameters that are initialized.)
- To use a motor capacity that is one rank lower than the inverter capacity, set **Pr.80 Motor capacity** before performing PM parameter initialization.
- The speed setting range for an MM-CF IPM motor is between 0 and 200 Hz.
- The carrier frequency is limited during PM sensorless vector control. (Refer to [page 356](#).)
- Constant-speed operation cannot be performed in the low-speed range of 200r/min or less under current synchronization operation. (Refer to [page 233](#).)
- During PM sensorless vector control, the RUN signal is output about 100 ms after turning ON the start command (STF, STR). The delay is due to the magnetic pole detection.
- During PM sensorless vector control, the automatic restart after instantaneous power failure function operates only when an MM-CF IPM motor is connected  
When a built-in brake or a regeneration unit is used, the frequency search may not be available at 2200 r/min or higher. The restart operation cannot be performed until the motor speed drops to a frequency where the frequency search is available.

## ◆ Driving a PM motor other than MM-CF

### Operating procedure

1. Setting the applied motor (**Pr.9, Pr.71, Pr.80, Pr.81, Pr.83,** and Pr.84). (Refer to [page 528](#), [page 551](#).)  
Set "8093 (IPM motor other than MM-CF) or 9093 (SPM motor)" in **Pr.71 Applied motor**. Set **Pr.9 Rated motor current, Pr.80 Motor capacity, Pr.81 Number of motor poles, Pr.83 Rated motor voltage,** and Pr.84 Rated motor frequency according to the motor specifications. (Setting "9999 (initial value)" in **Pr.80 or Pr.81** selects V/F control.)
2. Performing the offline auto tuning for a PM motor (**Pr.96**) (Refer to [page 551](#).)  
Set "1" (offline auto tuning without rotating motor (for other than MM-CF)) in **Pr.96**, and perform tuning.
3. Configure the initial setting for the PM sensorless vector control using **Pr.998**. (Refer to [page 231](#).)  
When the setting for the PM motor is selected in **Pr.998 PM parameter initialization**, the PM sensorless vector control is selected. [PM] on the operation panel (FR-DU08) is lit when the PM sensorless vector control is set.

setting	Description
8009	Parameter settings for an IPM motor other than MM-CF (rotations per minute)
8109	Parameter settings for an IPM motor other than MM-CF (frequency)
9009	Parameter settings (in rotations per minute) for an SPM motor
9109	Parameter settings (in frequencies) for an SPM motor

4. Set parameters such as the acceleration/deceleration time and multi-speed setting.  
Set parameters such as the acceleration/deceleration time and multi-speed setting as required.
5. Set the operation command. (Refer to [page 389](#).)  
Select the start command and speed command.
6. Perform the test operation.

### NOTE

- To change to the PM sensorless vector control, perform PM parameter initialization at first. If parameter initialization is performed after setting other parameters, some of those parameters are initialized too. (Refer to [page 231](#) for the parameters that are initialized.)
- To use a motor capacity that is one rank lower than the inverter capacity, set **Pr.80 Motor capacity** before performing PM parameter initialization.
- The carrier frequency is limited during PM sensorless vector control. (Refer to [page 356](#).)
- Constant-speed operation cannot be performed in the low-speed range of 200r/min or less under current synchronization operation. (Refer to [page 233](#).)
- During PM sensorless vector control, the RUN signal is output about 100 ms after turning ON the start command (STF, STR). The delay is due to the magnetic pole detection.

## 5.3.4 Setting the torque limit level

**Sensorless** **Vector** **PM**

Limit the output torque not to exceed the specified value.

The torque limit level can be set in a range of 0 to 400%. The TL signal can be used to switch between two types of torque limit. The torque limit level can be selected by setting it with a parameter, or by using analog input terminals (terminals 1, 4). Also, the torque limit levels of forward rotation (power driving/regenerative driving) and reverse rotation (power driving/regenerative driving) can be set individually.

Pr.	Name	Initial value	Setting range	Description
22 H500	Stall prevention operation level (Torque limit level)	150/200%*1	0 to 400%	Set the torque limit level as a percentage with regards to the rated torque as 100%.

Pr.	Name	Initial value	Setting range	Description	
85 G201	Excitation current break point	9999	0 to 400 Hz	Set a frequency of the low-speed range in the constant output range torque characteristic selection.	
			9999	SF-PR/SF-HR/SF-HRCA motor: The predetermined frequency is applied. Motor other than the above: 10 Hz is applied.	
86 G202	Excitation current low-speed scaling factor	9999	0 to 300%	Set a torque scaling factor applied to the operation in the low-speed range in the constant output range torque characteristic selection.	
			9999	SF-PR/SF-HR/SF-HRCA motor: The predetermined scaling factor is applied. Motor other than the above: 130% is applied.	
157 M430	OL signal output timer	0 s	0 to 25 s	Set the OL signal output start time at the activation of torque limit operation.	
			9999	No OL signal output.	
801 H704	Output limit level	9999	0 to 400%	Set the torque current limit level.	
			9999	The torque limit setting value is used for limiting the torque current level.	
803 G210	Constant output range torque characteristic selection	0	0	The torque rises in the low-speed range.	The motor power output is limited to be constant in the constant power range.
			1	The torque is kept constant in the low-speed range.	The torque is limited to be constant in the constant power range.
			2	The torque is kept constant in the low-speed range. (The torque current is limited.)	The torque is limited to be constant in the constant power range unless the output limit of the torque current is reached. (The torque current is limited.)
			10	The torque is kept constant in the low-speed range.	The motor power output is limited to be constant in the constant power range.
			11	The torque rises in the low-speed range.	The torque is limited to be constant in the constant power range.
804 D400	Torque command source selection	0	0	The internal torque limit 2 cannot be used.	
			1	Torque limit by the parameter setting ( <b>Pr.805</b> or <b>Pr.806</b> ) (-400 to 400%)	
			2	The internal torque limit 2 cannot be used	
			3	Torque limit through the CC-Link / CC-Link IE Field Network / CC-Link IE TSN communication (FR-A8NC, FR-A8NCE, FR-A800-GF, FR-A8NCG, FR-A800-GN)	
			4	The internal torque limit 2 cannot be used	
			6	Torque limit through the CC-Link / CC-Link IE Field Network / CC-Link IE TSN communication (FR-A8NC, FR-A8NCE, FR-A800-GF, FR-A8NCG, FR-A800-GN)	
805 D401	Torque command value (RAM)	1000%	600 to 1400%	Writes the torque limit value in RAM. Regards 1000% as 0%, and set torque command by an offset of 1000%.	
806 D402	Torque command value (RAM, EEPROM)	1000%	600 to 1400%	Writes the torque limit value in RAM and EEPROM. Regards 1000% as 0%, and set torque command by an offset of 1000%.	
810 H700	Torque limit input method selection	0	0	Internal torque limit 1 (torque limited by parameter settings)	
			1	External torque limit (torque limited by terminals 1 and 4)	
			2	Internal torque limit 2 (torque limited by communication options)	
811 D030	Set resolution switchover	0	0	Speed setting, running speed monitor increments 1 r/min	Torque limit setting increments 0.1%
			1	Speed setting, running speed monitor increments 0.1 r/min	
			10	Speed setting, running speed monitor increments 1 r/min	Torque limit setting increments 0.01%
			11	Speed setting, running speed monitor increments 0.1 r/min	
812 H701	Torque limit level (regeneration)	9999	0 to 400%	Set the torque limit level for forward rotation regenerative driving.	
			9999	Limit using <b>Pr.22</b> or the analog terminal values.	

Pr.	Name	Initial value	Setting range	Description
813 H702	Torque limit level (3rd quadrant)	9999	0 to 400% 9999	Set the torque limit level for reverse rotation power driving. Limit using <b>Pr.22</b> or the analog terminal values.
814 H703	Torque limit level (4th quadrant)	9999	0 to 400% 9999	Set the torque limit level for reverse rotation regenerative driving. Limit using <b>Pr.22</b> or the analog terminal values.
815 H710	Torque limit level 2	9999	0 to 400% 9999	When the torque limit selection (TL) signal is ON, <b>Pr.815</b> is the torque limit value regardless of <b>Pr.810</b> . The torque limit set to <b>Pr.810</b> is valid.
816 H720	Torque limit level during acceleration	9999	0 to 400% 9999	Set the torque limit value during acceleration. The same torque limit as constant speed.
817 H721	Torque limit level during deceleration	9999	0 to 400% 9999	Set the torque limit value during deceleration. The same torque limit as constant speed.
858 T040	Terminal 4 function assignment	0	0, 1, 4, 9999	The torque limit level can be changed with setting value "4" and the signal to terminal 4.
868 T010	Terminal 1 function assignment	0	0 to 6, 9999	The torque limit level can be changed with setting value "4" and the signal to terminal 1.
874 H730	OLT level setting	150%	0 to 400%	The inverter can be set to be shut off at activation of torque limit and stalling of the motor. Set the output to be shut off.

\*1 When changing from V/F control or Advanced magnetic flux vector control to Real sensorless vector control or Vector control in the FR-A820-00250(3.7K) or lower or the FR-A840-00126(3.7K) or lower, 150% changes to 200%.

#### NOTE

- The lower limit for the torque limit level under Real sensorless vector control is set to 30% even if a value lower than 30% is set.
- When the low-speed range high-torque characteristic is disabled under PM sensorless vector control (**Pr.788** = "0"), the torque limit is not activated in a low-speed range with a rated frequency of less than 10%.
- Under PM sensorless vector control, the torque limit level is reduced inversely proportional to the output frequency in the constant output range of the rated motor frequency or higher.

### ◆ Block diagram of torque limit

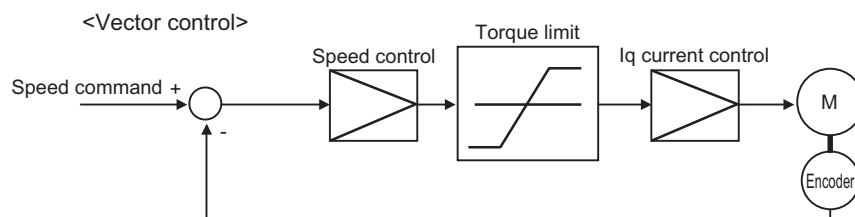

### ◆ Selecting the torque limit input method (Pr.810)

- Use **Pr.810 Torque limit input method selection** to select the method to limit the output torque for speed control. The method in the initial setting is use of the parameter settings.

Pr.810 setting	Torque limit input method	Operation
0 (initial value)	Internal torque limit 1	Perform the torque limit operation using the parameter ( <b>Pr.22, Pr.812 to Pr.814</b> ) settings. If changing the torque limit parameters via communication is enabled, the torque limit input can be performed via communication.
1	External torque limit	Torque limit using analog voltage (current) to terminal 1 or terminal 4 is valid.
2	(Internal torque limit 2)	The torque limit through the CC-Link (FR-A8NC) or CC-Link IE Field Network (FR-A8NCE/FR-A800-GF) communication is valid.

### ◆ Torque limit level using parameter settings (Pr.810 = "0", Pr.812 to Pr.814)

- The torque is limited by parameter setting (Internal torque limit 1).
- In the initial value, a limit is applied to all quadrants by **Pr.22 Stall prevention operation level (Torque limit level)**.

- To set individually for each quadrant, use **Pr.812 Torque limit level (regeneration)**, **Pr.813 Torque limit level (3rd quadrant)**, **Pr.814 Torque limit level (4th quadrant)**. When "9999" is set, **Pr.22** setting is regarded as torque limit level in all the quadrants.

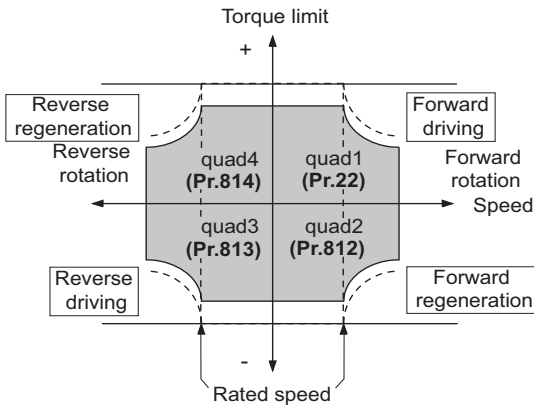

### ◆ Torque limit level using analog input (terminals 1, 4) (Pr.810 = "1", Pr.858, Pr.868)

- The torque is limited with the analog input of terminal 1 or terminal 4. (External torque limit)
- Torque limit using analog input is valid with a limit value lower than the internal torque limit (**Pr.22, Pr.812 to Pr.814**). (If the torque limit using analog input exceeds the internal torque limit, the internal torque limit is valid.)
- When inputting the torque limit value from terminal 1, set **Pr.868 Terminal 1 function assignment** = "4". When inputting from terminal 4, set **Pr.858 Terminal 4 function assignment** = "4".
- When **Pr.858** = "4" and **Pr.868** = "2", the torque for regenerative driving is limited with the terminal 1 analog input, and the torque for power driving is limited with the terminal 4 analog input.

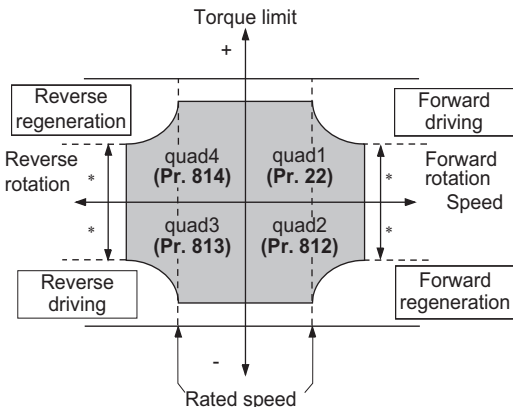

\* Analog input (terminal 1, 4) or internal torque control (Pr. 22 etc.) whichever is smaller

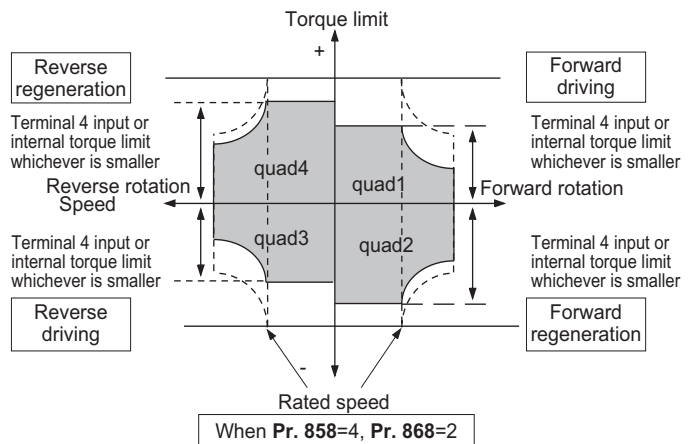

- The torque limit using analog input can be corrected with the calibration parameters **C16 (Pr.919) to C19 (Pr.920)**, and **C38 (Pr.932) to C41 (Pr.933)**. (Refer to [page 510](#).)

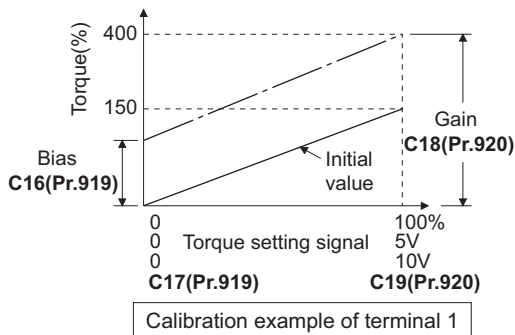

Calibration example of terminal 1

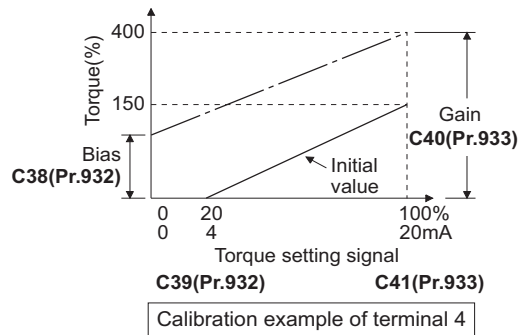

Calibration example of terminal 4

**NOTE**

- When inputting an analog signal to the terminal 1, give a positive voltage (0 to +10 V (+5 V)).  
When a negative voltage (0 to -10 V (-5 V)) is input, the torque limit value set by the analog signal becomes "0".

- Functions of terminals 1 and 4 by control (— : no function)

Pr.858 setting <sup>*1</sup>	Terminal 4 function	Pr.868 setting <sup>*2</sup>	Terminal 1 function
0 (initial value)	Speed command (AU signal-ON)	0 (initial value)	Speed setting assistance
		1 <sup>*4</sup>	Magnetic flux command <sup>*4</sup>
		2	—
		3	—
		4	Torque limit (Pr.810 = "1")
		5	—
		6	Torque bias (Pr.840 = "1 to 3")
	9999	—	—
1 <sup>*4</sup>	Magnetic flux command <sup>*4</sup>	0 (initial value)	Speed setting assistance
	— <sup>*3</sup>	1 <sup>*4</sup>	Magnetic flux command <sup>*4</sup>
	Magnetic flux command <sup>*4</sup>	2	—
		3	—
		4	Torque limit (Pr.810 = "1")
		5	—
		6	Torque bias (Pr.840 = "1 to 3")
	9999	—	—
4 <sup>*2</sup>	Torque limit (Pr.810 = "1")	0 (initial value)	Speed setting assistance
		1 <sup>*4</sup>	Magnetic flux command <sup>*4</sup>
	Power driving torque limit (Pr.810 = "1")	2	Regenerative torque limit (Pr.810 = "1")
	Torque limit (Pr.810 = "1")	3	—
	— <sup>*3</sup>	4	Torque limit (Pr.810 = "1")
	Torque limit (Pr.810 = "1")	5	—
		6	Torque bias (Pr.840 = "1 to 3")
		9999	—
9999	—	—	—

\*1 When Pr.868 ≠ "0", the other functions of terminal 1 (auxiliary input, override function, PID control) do not operate.

\*2 When Pr.858 ≠ "0", PID control and speed commands using terminal 4 do not operate even when the AU signal is ON.

\*3 When both Pr.858 and Pr.868 are "1" (magnetic flux command) or "4" (torque limit), the function of terminal 1 has higher priority, and terminal 4 does not function.

\*4 Valid when Vector control compatible options are installed and the Vector control is selected.

### ◆ Torque limit level through the CC-Link / CC-Link IE Field Network / CC-Link IE TSN communication (Pr.810 = "2", Pr.805, Pr.806)

- When the CC-Link (FR-A8NC), CC-Link IE Field network (FR-A8NCE/FR-A800-GF), or CC-Link IE TSN (FR-A8NCG/FR-A800-GN) communication is used, the Pr.805 or Pr.806 setting is used as the torque limit value. (Internal torque limit 2)
- When the CC-Link communication (Ver. 2) is used in the quadruple or octuple setting (Pr.544 = "14, 18, 114, or 118"), the torque limit value can be input using a remote register (RWwC).
- When the CC-Link IE Field Network or CC-Link IE TSN is used, the torque limit value can be input using a remote register (RWw2).

Pr.804 setting	Torque limit input		Setting range <sup>*1</sup>	Setting increments
	CC-Link/PLC function	CC-Link IE Field Network / CC-Link IE TSN		
1	Torque limit by Pr.805, Pr.806 <sup>*2</sup>	Torque limit by remote register (RWw2) <sup>*3</sup>	600 to 1400 (-400% to 400%)	1%
3	Torque limit by remote register (RWw2) <sup>*3</sup>			
5	Torque limit by remote register (RWw2) <sup>*3</sup>	Torque limit by remote register (RWw2) <sup>*3</sup>	-32768 to 32767 (two's complement) (-327.68% to 327.67%) <sup>*4</sup>	0.01% <sup>*4</sup>
6	Torque limit by Pr.805, Pr.806 <sup>*2</sup>			

\*1 The torque limit setting is defined as an absolute value.

- \*2 Can also be set from operation panel or parameter unit.
- \*3 The torque can also be limited by setting a value in **Pr.805** or **Pr.806**.
- \*4 If set by operation panel or parameter unit, setting range is "673 to 1327 (-327% to 327%)", setting increment is 1%.

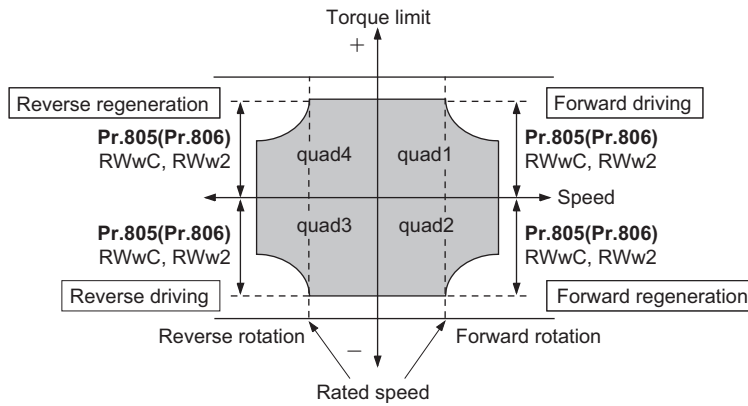

- When the CC-Link communication (Ver. 2) is used in the quadruple or octuple setting (**Pr.544** = "24, 28, or 128"), the torque limit value can be input using a remote register (RWwC to RWwF) for each of the four quadrants.

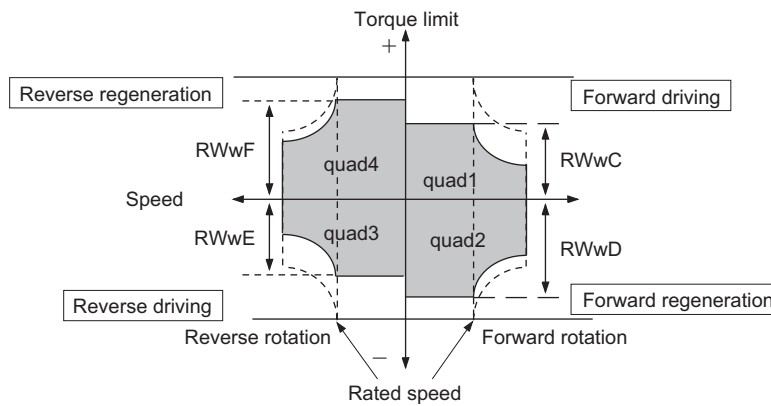

**NOTE**

- When "2" is set in **Pr.810** while the communication option is not connected, a protective function (E.OPT) is activated. (PLC function disabled)
- For details on the FR-A8NC, FR-A8NCE, or FR-A8NCG, refer to the Instruction Manual of each option. For details on the CC-Link IE Field Network, refer to [page 752](#). For details on CC-Link IE TSN communication, refer to the CC-Link IE TSN Function Manual.

**◆ Second torque limit level (TL signal, Pr.815)**

- For **Pr.815 Torque limit level 2**, when the Torque limit selection (TL) signal is ON, the setting value of **Pr.815** is the limit value regardless of the setting of **Pr.810 Torque limit input method selection**.
- To assign the TL signal, set "27" in any of **Pr.178 to Pr.189** (Input terminal function selection).

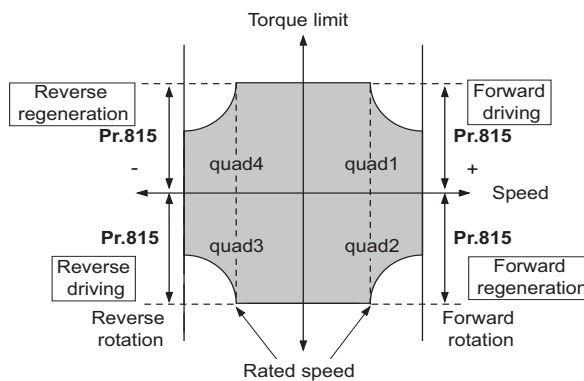

**NOTE**

- Changing the terminal assignment using **Pr.178 to Pr.189 (Input terminal function selection)** may affect the other functions. Set parameters after confirming the function of each terminal.

### ◆ Setting the torque limit values during acceleration/deceleration individually (Pr.816, Pr.817)

- The torque limit during acceleration and deceleration can be set individually. Torque limit using the setting values of **Pr.816 Torque limit level during acceleration** and **Pr.817 Torque limit level during deceleration** is as follows.
- If 1 second elapses while the difference between the set speed and rotation speed is within  $\pm 2$  Hz, the torque limit level during acceleration/deceleration (**Pr.816** or **Pr.817**) changes to the torque control level during constant speed (**Pr.22**).
- When the difference between the set speed and rotation speed is  $-2$  Hz or less, the torque limit level during deceleration Torque limit level during deceleration (**Pr.817**) activates.

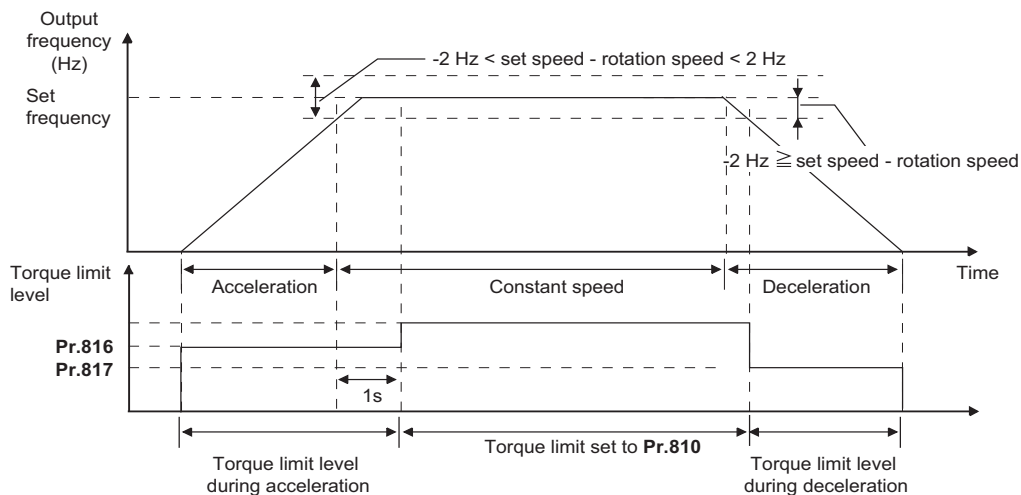

**NOTE**

- The **Pr.816** and **Pr.817** settings are invalid under position control.

### ◆ Changing the setting increments of the torque limit level (Pr.811)

- The setting increments of **Pr.22 Torque limit level**, **Pr.801 Output limit level**, and **Pr.812 to Pr.817 Torque limit level** can be changed to 0.01% by setting **Pr.811 Set resolution switchover** = "10 or 11".

Pr.811 setting	Increments of speed setting and running speed monitoring <sup>*1</sup>	Torque limit setting increments
0	1 r/min	0.1%
1	0.1 r/min	
10	1 r/min	0.01%
11	0.1 r/min	

\*1 For details on the increments of speed setting and running speed monitoring, refer to [page 444](#).

**NOTE**

- The internal resolution of the torque limit is 0.024% ( $100/2^{12}$ ), and fractions below this resolution are rounded off.
- When Real sensorless vector control is selected, fractions below a resolution equivalent to 0.1% are rounded off even if **Pr.811** = "10 or 11" is set.
- For details on changing the speed setting increments, refer to [page 444](#).

### ◆ Changing the torque characteristic of the constant-power range (Pr.801, Pr.803)

- Under Real sensorless vector control or Vector control, the torque characteristic can be changed between in the low-speed range and in the constant power range.



- Use **Pr.85 Excitation current break point** to change the low-speed range, and use **Pr.86 Excitation current low-speed scaling factor** to change the torque in the low-speed range. When **Pr.85** = "9999 (initial value)", a predetermined frequency is used. When **Pr.86** = "9999 (initial value)", a predetermined scaling factor is used (refer to [page 711](#)).

Pr.803 setting	Torque characteristic in low-speed range	Torque characteristic in constant-power range	
		Torque characteristic	Output limit
0 (initial value)	The torque changes according to the scaling factor set in <b>Pr.86</b> . <sup>*1</sup>	Constant motor output	—
1	Constant torque	Constant torque	Without
2	Constant torque	Constant torque	With
10	Constant torque	Constant motor output	—
11	The torque changes according to the scaling factor set in <b>Pr.86</b> . <sup>*1</sup>	Constant torque	Without

\*1 This is applicable only under Real sensorless vector control. The upper limit of the torque at 0 Hz is determined by multiplying the torque limit in the constant-torque range by the scaling factor set in **Pr.86**.

- To avoid overload or overcurrent of the inverter or motor, use **Pr.801 Output limit level** to limit the torque current.

Pr.801 setting	Description
0 to 400%	Set the torque current limit level.
9999	The torque limit setting value ( <b>Pr.22, Pr.812 to Pr.817, etc.</b> ) is used for limiting the torque current.

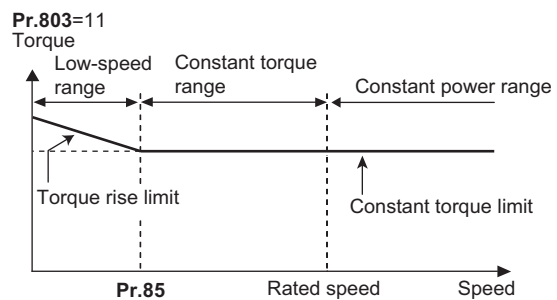
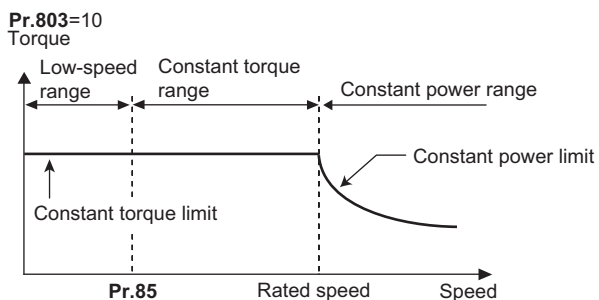
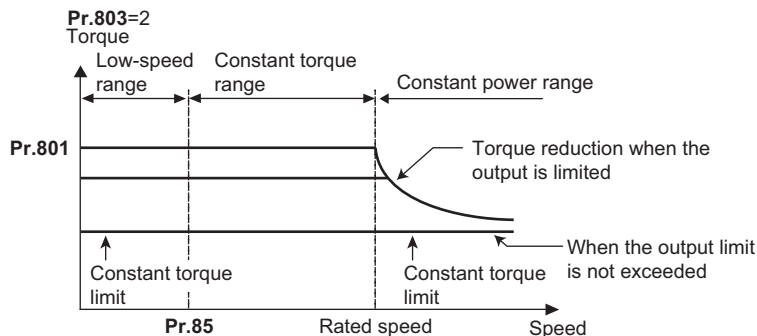
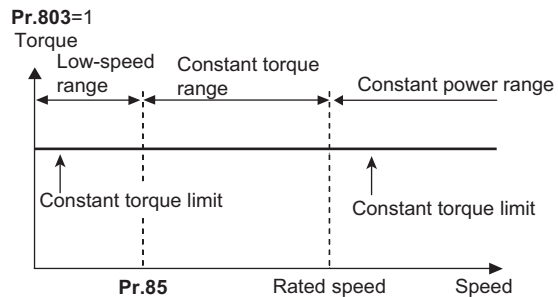
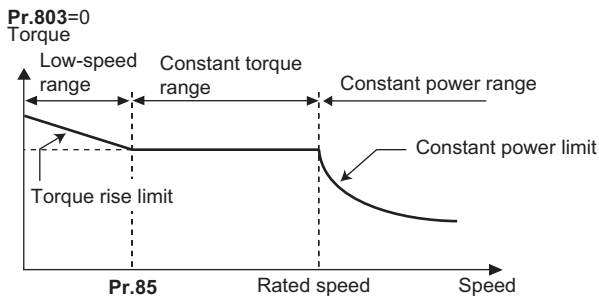

**NOTE**

- When the torque limit setting value (**Pr.22, Pr.812 to Pr.817, etc.**) is less than the value set in **Pr.801**, the **Pr.801** setting is used for limiting the torque current.

**◆ Trip during torque limit operation (Pr.874)**

- The inverter can be set to be shut off at activation of torque limit and stalling of the motor.

- When a high load is applied and the torque limit is activated under speed control or position control, the motor stalls. At this time, if a state where the rotation speed is lower than the value set in **Pr.865 Low speed detection** and the output torque exceeds the level set in **Pr.874 OLT level setting** continues for 3 seconds, Stall prevention stop (E.OLT) is activated and the inverter output is shut off.

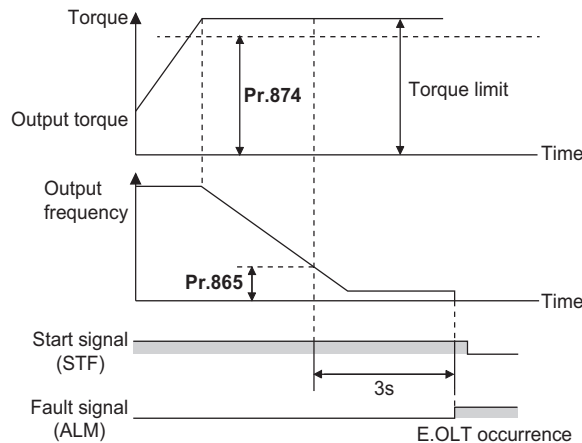

#### NOTE

- Under V/F control or Advanced magnetic flux vector control, if the output frequency drops to 0.5 Hz due to the stall prevention operation and this state continues for 3 seconds, a fault indication (E.OLT) appears, and the inverter output is shut off. This operation is activated regardless of the **Pr.874** setting.
- This fault does not occur under torque control.

### ◆ Adjusting the signal output under torque limit operation and output timing (OL signal, Pr.157)

- If the output torque exceeds the torque limit level and the torque limit is activated, the overload warning (OL signal) is turned ON for 100 ms or longer. When the output torque drops to the torque limit level or lower, the output signal also turns OFF.
- Pr.157 OL signal output timer** can be used to set whether to output the OL signal immediately, or whether to output it after a certain time period has elapsed.

Pr.157 setting value	Description
0 (initial value)	Output immediately.
0.1 to 25	Output after the set time (s).
9999	Not output.

- The OL signal is also output during the regeneration avoidance operation ("**OL**" display (overvoltage stall)).

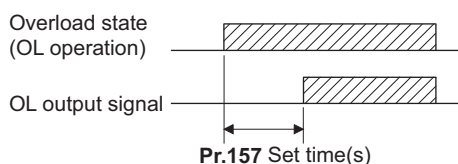

#### NOTE

- The OL signal is assigned to terminal OL in the initial status. The OL signal can also be assigned to other terminals by setting "3 (positive logic) or 103 (negative logic)" in any of **Pr.190 to Pr.196** (Output terminal function selection).
- Changing the terminal assignment using **Pr.190 to Pr.196 (Output terminal function selection)** may affect the other functions. Set parameters after confirming the function of each terminal.

#### Parameters referred to

**Pr.22** Stall prevention operation level [page 431](#)  
**Pr.178 to Pr.189** (Input terminal function selection) [page 521](#)  
**Pr.190 to Pr.196** (Output terminal function selection) [page 473](#)  
**Pr.840** Torque bias selection [page 265](#)  
**Pr.865** Low speed detection [page 484](#)

## 5.3.5 Performing high-accuracy, fast-response control (gain adjustment for Real sensorless vector control, Vector control, and PM sensorless vector control)

**Sensorless** **Vector** **PM**

The load inertia ratio (load moment of inertia) for the motor is calculated in real time from the torque command and rotation speed during motor driving by the Vector control. Because the optimum gain for speed control and position control is set automatically from the Load inertia ratio and the response level, the work required for gain adjustment is reduced. (Easy gain tuning)

If the load inertia ratio cannot be calculated due to load fluctuations, or under Real sensorless vector control or PM sensorless vector control, the control gain can be set automatically by entering the load inertia ratio manually.

Manual gain adjustment is useful for achieving optimum machine performance or improving unfavorable conditions, such as vibration and acoustic noise during operation with high load inertia or gear backlash.

Pr.	Name	Initial value	Setting range	Description
818 C112	Easy gain tuning response level setting	2	1 to 15	Set the response level. 1 (Slowest) to 15 (Fastest)
819 C113	Easy gain tuning selection	0	0	No easy gain tuning
			1	Gain is calculated with load calculation (This function is valid under Vector control.)
			2	Gain is calculated with load ( <b>Pr.880</b> ) manual input
820 G211	Speed control P gain 1	60%	0 to 1000%	The proportional gain during speed control is set. (Setting this parameter higher improves the trackability for speed command changes. It also reduces the speed fluctuation caused by external disturbance.)
821 G212	Speed control integral time 1	0.333 s	0 to 20 s	The integral time during speed control is set. (Setting this parameter lower shortens the return time to the original speed when the speed fluctuates due to external disturbance.)
830 G311	Speed control P gain 2	9999	0 to 1000%	Second function of <b>Pr.820</b> (valid when RT signal is ON)
			9999	The <b>Pr.820</b> setting is applied to the operation.
831 G312	Speed control integral time 2	9999	0 to 20 s	Second function of <b>Pr.821</b> (enabled when the RT signal is ON)
			9999	The <b>Pr.821</b> setting is applied to the operation.
880 C114	Load inertia ratio	7-fold	0 to 200-fold	Set the load inertia ratio for the motor.
1115 G218	Speed control integral term clear time	0 ms	0 to 9998 ms	Set time until the integral term is reduced and cleared after P control switching.
1116 G206	Constant output range speed control P gain compensation	0%	0 to 100%	Set a compensation amount of the speed control P gain in the constant output range (rated speed or higher).
1117 G261	Speed control P gain 1 (per-unit system)	9999	0 to 300	Set a proportional gain under speed control in the per-unit system.
			9999	The <b>Pr.820</b> setting is applied to the operation.
1118 G361	Speed control P gain 2 (per-unit system)	9999	0 to 300	Second function of <b>Pr.1117</b> (valid when RT signal ON)
			9999	The <b>Pr.1117</b> setting is applied to the operation.
1121 G260	Per-unit speed control reference frequency	120 Hz <sup>*1</sup>	0 to 400 Hz	Set the speed at 100% when setting speed control P gain or model speed control gain in the per-unit system.
		60 Hz <sup>*2</sup>		
1348 G263	P/PI control switchover frequency	0 Hz	0 to 400 Hz	Set the motor speed for the P/PI control switchover.

\*1 For the FR-A820-03160(55K) or lower, and FR-A840-01800(55K) or lower.

\*2 For the FR-A820-03800(75K) or higher, and FR-A840-02160(75K) or higher.

## ◆ Block diagram of easy gain tuning function

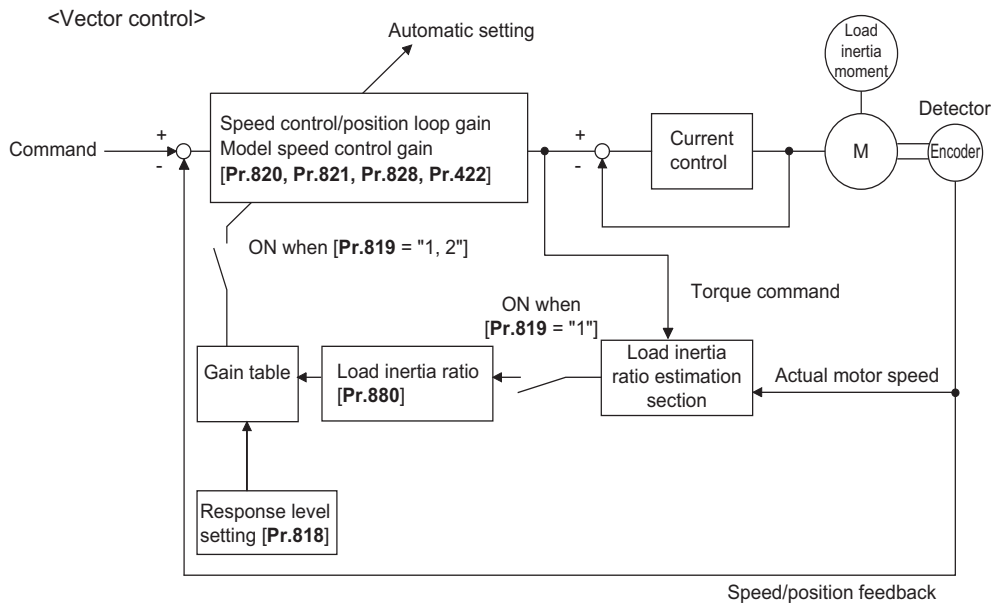

### NOTE

- Easy gain tuning is valid for the first motor. When applying the second motor (RT signal is ON), tuning is not performed.

## ◆ Execution procedure for easy gain tuning (Pr.819 = "1" Load inertia ratio automatic calculation)

Easy gain tuning (load inertia ratio automatic calculation) is only valid in the speed control and position control modes of Vector control. It is invalid under torque control, V/F control, Advanced magnetic flux vector control, Real sensorless vector control, and PM sensorless vector control.

### 1. Set the response level in Pr.818 Easy gain tuning response level setting.

Setting this parameter higher improves the trackability for commands, but setting it too high causes vibration. The following figure shows the relationship between the setting and the response level.

Pr. 818 setting	1	2	3	4	5	6	7	8	9	10	11	12	13	14	15
Response level	Slowest response			← Middle response						Fastest response					
Guideline of mechanical resonance frequency (Hz)	8	10	12	15	18	22	28	34	42	52	64	79	98	122	150
Inverter application															

### 2. The load inertia ratio is calculated during acceleration/deceleration, and from this value and the value of Pr.818 Easy gain tuning response level setting, the gain for each control is set automatically.

**Pr.880 Load inertia ratio** is used as the initial value of the load inertia ratio when performing tuning. During tuning, the estimated value is set in **Pr.880**.

The calculation of the load inertia ratio may take excessive time or otherwise not be performed properly if the following conditions are not satisfied.

- The time in acceleration/deceleration driving until 1500 r/min is reached in 5 seconds or less.
- The rotation speed in driving is 150 r/min or higher.
- The acceleration/deceleration torque is 10% or higher.
- No sudden external disturbances during acceleration/deceleration.
- The load inertia ratio is about 30-fold or lower.
- No gear backlash or belt sagging.

3. Press **FWD** or **REV** to calculate the continuous load inertia ratio, or calculate the gain.  
(The operation command during External operation is the STF or STR signal.)

## ◆ Execution procedure for easy gain tuning (Pr.819 = "2" Load inertia ratio manual input)

Easy gain tuning (Load inertia ratio manual input) is valid in the speed control mode under Real sensorless vector control, the speed control and position control modes under Vector control, and the speed control mode under PM sensorless vector control.

1. Set the load inertia ratio for the motor in **Pr.880 Load inertia ratio**.
2. Set "2" (easy gain tuning enabled) in **Pr.819 Easy gain tuning selection**. After setting, **Pr.820 Speed control P gain 1** and **Pr.821 Speed control integral time 1** are set automatically.  
Operation is performed with the adjusted gain from the next operation.
3. Perform the test operation, and set the response level in **Pr.818 Easy gain tuning response level setting**. Setting this parameter higher improves the trackability for commands, but setting it too high causes vibration. (The response level can be adjusted during operation when **Pr.77 Parameter write selection** = "2" (parameters can be written during operation).)

### NOTE

- When **Pr.819** = "1 or 2" is set, even if the **Pr.819** setting value is returned to "0" after tuning is performed, the data that was set in each parameter is retained in the tuning results.
- If good precision cannot be obtained even after executing easy gain tuning, because of external disturbances or other reasons, perform fine adjustment manually. At this time, set the setting value of **Pr.819** to "0" (no easy gain tuning).

## ◆ Parameters set automatically by easy gain tuning

The following table shows the relationship between the easy gain tuning function and gain adjustment parameters.

	Easy gain tuning selection (Pr.819) setting		
	0	1	2
<b>Pr.880 Load inertia ratio</b>	Manual input	The inertia calculation result (RAM) using easy gain tuning is displayed. The parameter is set at the following times. <ul style="list-style-type: none"> <li>• Every hour after turning ON the power</li> <li>• When <b>Pr.819</b> is set to a value other than "1"</li> <li>• After changing to a control other than Vector control (such as V/F control) using <b>Pr.800</b> Write (manual input) is available only during a stop.</li> </ul>	Manual input
<b>Pr.820 Speed control P gain 1</b> <b>Pr.821 Speed control integral time 1</b> <b>Pr.828 Model speed control gain</b> <b>Pr.422 Position control gain</b> <b>Pr.446 Model position control gain</b>	Manual input	The tuning result (RAM) is displayed. The parameter is set at the following times. <ul style="list-style-type: none"> <li>• Every hour after turning ON the power</li> <li>• When <b>Pr.819</b> is set to a value other than "1"</li> <li>• After changing to a control other than Vector control (such as V/F control) using <b>Pr.800</b> Write (manual input) is not available</li> </ul>	Gain is calculated when <b>Pr.819</b> is set to "2", and the result is set in the parameter. When read, the tuning result (parameter setting value) is displayed. Write (manual input) is not available

### NOTE

- If easy gain tuning is executed at an inertia equal to or higher than the specified value under Vector control, a fault such as hunting may occur. Also, if the motor shaft is fixed by the servo lock or position control, the bearing may be damaged. In this case, do not perform easy gain tuning. Adjust the gain manually.
- The load inertia ratio is only calculated under Vector control.

## ◆ Adjusting the speed control gain manually (Pr.819 = "0" No easy gain tuning)

- The speed control gain can be adjusted for the conditions such as abnormal machine vibration, acoustic noise, slow response, and overshoot.
- Setting 60% (initial value) in **Pr.820 Speed control P gain 1** is equivalent to 120 rad/s (speed response of a single motor). (Equivalent to the half the rad/s value during Real sensorless vector control or with the FR-A820-03800(75K) or higher and the FR-A840-02160(75K) or higher during Vector control.) Setting this parameter higher speeds up the response, but setting this too high causes vibration and acoustic noise.
- Setting **Pr.821 Speed control integral time 1** lower shortens the return time to the original speed during speed fluctuation, but setting it too low causes overshoot.

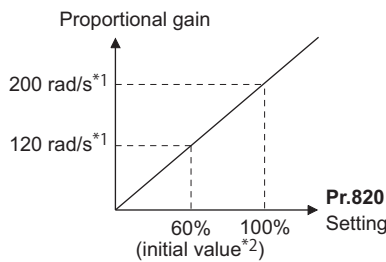

\*1 The following shows the response level to the proportional gain.

Pr.820 setting	Response level (rad/s)			
	FR-A820-03160(55K) or lower FR-A840-01800(55K) or lower		FR-A820-03800(75K) or higher FR-A840-02160(75K) or higher	
	Vector control	Real sensorless vector control	Vector control	Real sensorless vector control
60	120	60	60	30
100	200	100	100	50

\*2 Performing PM parameter initialization changes the settings. (Refer to [page 231](#).)

- Actual speed gain is calculated as follows when load inertia is applied.

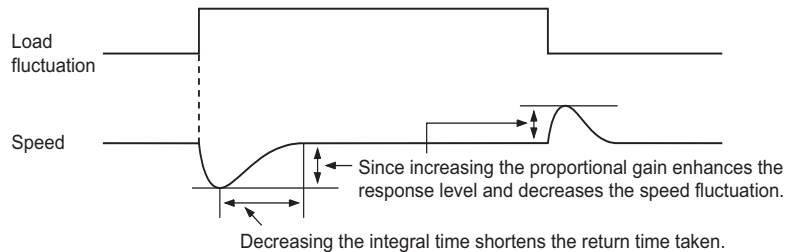

$$\text{Actual speed gain} = \text{Speed gain of a single motor} \times \frac{JM}{JM+JL}$$

JM: Motor inertia  
JL: Load inertia converted as the motor axis inertia

## ◆ Adjustment procedure

1. Change the **Pr.820** setting while checking the conditions.
2. If it cannot be adjusted well, change **Pr.821** setting, and perform step **1** again.

No.	Movement / condition	Adjustment method
1	Load inertia is too high.	Set <b>Pr.820 and Pr.821</b> higher.
		<b>Pr.820</b> If acceleration is slow, raise the setting by 10% and then set the value to 80 to 90% of the setting immediately before vibration/noise starts occurring.
		<b>Pr.821</b> If overshoots occur, set about 80 to 90% of the maximum value without overshooting while increasing the setting value by twice.
2	Vibration or acoustic noise are generated from machines.	Set <b>Pr.820</b> lower and <b>Pr.821</b> higher.
		<b>Pr.820</b> Set about 80 to 90% of the maximum value without any vibration/noise while decreasing the setting value by 10%.
		<b>Pr.821</b> If overshoots occur, set about 80 to 90% of the maximum value without overshooting while increasing the setting value by twice.
3	Response is slow.	Set <b>Pr.820</b> higher.
		<b>Pr.820</b> If acceleration is slow, set about 80 to 90% of the maximum value without any vibration/ acoustic noise while increasing the setting value by 5%.
4	Return time (response time) is long.	Set <b>Pr.821</b> lower.
		Set about 80 to 90% of the maximum value without overshooting or unstable movements while decreasing the setting value of <b>Pr.821</b> by half.
5	Overshoots or unstable movements occur.	Set <b>Pr.821</b> higher.
		Set about 80 to 90% of the maximum value without overshooting or unstable movements while increasing the setting value of <b>Pr.821</b> by double.

### NOTE

- When adjusting the gain manually, set **Pr.819 Easy gain tuning selection** to "0" (no easy gain tuning) (initial value).
- **Pr.830 Speed control P gain 2** and **Pr.831 Speed control integral time 2** are valid when terminal RT is ON. In this case, replace them for **Pr.820 and Pr.821** in the description above.

## ◆ When using a multi-pole motor (8 poles or more)

- If the motor inertia is known, set **Pr.707 Motor inertia (integer)** and **Pr.724 Motor inertia (exponent)**. (Refer to [page 532.](#))
- Under Real sensorless vector control or Vector control, adjust **Pr.820 Speed control P gain 1** and **Pr.824 Torque control P gain 1 (current loop proportional gain)** to suit the motor, by referring to the following methods.
- Setting the parameter of **Pr.820 Speed control P gain 1** higher speeds up the response, but setting this too high causes vibration and acoustic noise.
- Setting the parameter of **Pr.824 Torque control P gain 1 (current loop proportional gain)** too low causes current ripple, and a noise synchronous with this will be emitted from the motor.
- Adjustment method:

No.	Movement / condition	Adjustment method
1	Motor rotation speed in the low-speed range is unstable.	<b>Pr.820 Speed control P gain 1</b> must be set higher according to the motor inertia. For multi-pole motors, because the inertia of the motor itself tends to be large, first perform broad adjustment to improve the unstable movements, and then perform fine adjustment by referring to the response level based on this setting. Also, for Vector control, gain adjustment appropriate for the inertia can be easily performed by using easy gain tuning ( <b>Pr.819</b> = "1").
2	Rotation speed trackability is poor.	Set <b>Pr.820 Speed control P gain 1</b> higher. Raise the setting by 10% and set a value that approximately 80% to 90% of the setting right before vibration/noise starts occurring. If it cannot be adjusted well, double <b>Pr.821 Speed control integral time 1</b> and perform the adjustment of <b>Pr.820</b> again.
3	Large fluctuation of the rotation speed relative to load fluctuation.	Set the speed control gain higher. (The same as No.1.) If this cannot be prevented through gain adjustment, raise <b>Pr.13 Starting frequency</b> for a fault that occurs when starting, or shorten the acceleration time and avoid continuous operation in a low-speed range.
4	Torque shortage or motor backlash occurs when starting or passing a low-speed range under Real sensorless vector control.	Set the speed control gain higher. (The same as No.1.) If this cannot be prevented through gain adjustment, raise <b>Pr.13 Starting frequency</b> for a fault that occurs when starting, or shorten the acceleration time and avoid continuous operation in a low-speed range.
5	Unusual vibration, noise and overcurrent of the motor or machine occurs.	Set <b>Pr.824 Torque control P gain 1 (current loop proportional gain)</b> lower.
6	Overcurrent or overspeed (E.OS) occurs when starting under Real sensorless vector control.	Lower the setting by 10% and set a value that is approximately 80% to 90% of the setting immediately before the condition improves.

## ◆ Compensating the speed control P gain in the constant output range (Pr.1116)

- In the constant output range (rated speed or higher), the response of speed control is reduced due to weak field. Thus, the speed control P gain is needed to be compensated using **Pr.1116 Constant output range speed control P gain compensation**.
- In **Pr.1116**, set a compensation amount for the doubled rated speed regarding the speed control P gain at the rated speed or lower as 100%.

(Speed control P gain at rated speed or higher) = (Speed control P gain at rated speed or lower) × (100% + compensation amount)

Compensation amount = **Pr.1116**/Rated speed × (Speed - Rated speed)

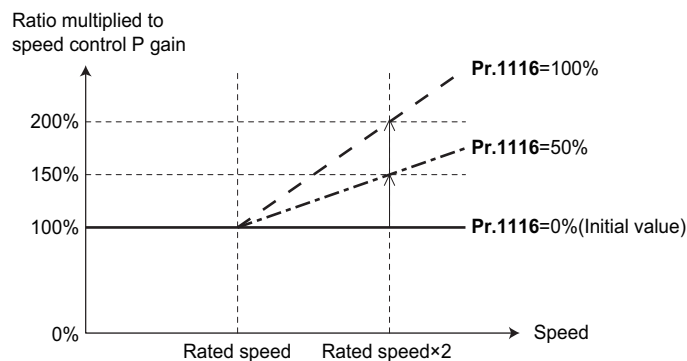

## ◆ Setting the speed control P gain in the per-unit system (Pr.1117, Pr.1118, Pr.1121)

- The speed control P gain can be set in the per-unit (pu) system.
- In the per-unit system:  
When "1" is set, the torque (Iq) command is 100% (rated Iq) when the speed deviation is 100%.  
When "10" is set, the torque (Iq) command is 10% (rated Iq) when the speed deviation is 100%.  
Set the 100% speed in **Pr.1121 Per-unit speed control reference frequency**.
- The speed control P gain becomes as follows according to **Pr.1117 Speed control P gain 1 (per-unit system)**, **Pr.1118 Speed control P gain 2 (per-unit system)**, and the RT signal.

Pr.1117	Pr.1118	Pr.830	RT signal	Speed control P gain
9999	9999	—	OFF	<b>Pr.820</b>
		9999	ON	<b>Pr.820</b>
		Other than 9999	ON	<b>Pr.830</b>
Other than 9999	9999	—	—	<b>Pr.1117</b>
9999	Other than 9999	—	OFF	<b>Pr.820</b>
			ON	<b>Pr.1118</b>
Other than 9999	Other than 9999	—	OFF	<b>Pr.1117</b>
			ON	<b>Pr.1118</b>

### NOTE

- The per-unit system setting is available only under Real sensorless vector control or Vector control.
- When the speed control P gain or model speed control gain is set in the per-unit system, the easy gain tuning selection (**Pr.819** = "1 or 2") becomes invalid.

## ◆ Switching over P/PI control (Pr.1115, X44 signal)

- In speed control under Real sensorless vector control or Vector control, whether or not to add the integral time (I) when performing gain adjustment with P gain and integral time can be performed with the P/PI control switchover signal (X44).  
When X44 signal is OFF...PI control  
When X44 signal is ON...P control



- To input the X44 signal, set "44" in any of **Pr.178 to Pr.189 (Input terminal function selection)** to assign the function to a terminal.
- The shock of P/PI control switchover is absorbed by setting **Pr.1115 Speed control integral term clear time**. When the X44 signal is turned ON, integration is stopped and the accumulated integral term is reduced and cleared according to the setting of **Pr.1115 Speed control integral term clear time** (initial value is 0 ms).

In **Pr.1115**, set time when the integral term is reduced from 100% to 0% regarding the rated torque current (I<sub>q</sub>) as 100%. Turning OFF the X44 signal resumes the integral operation.

[Function block diagram]

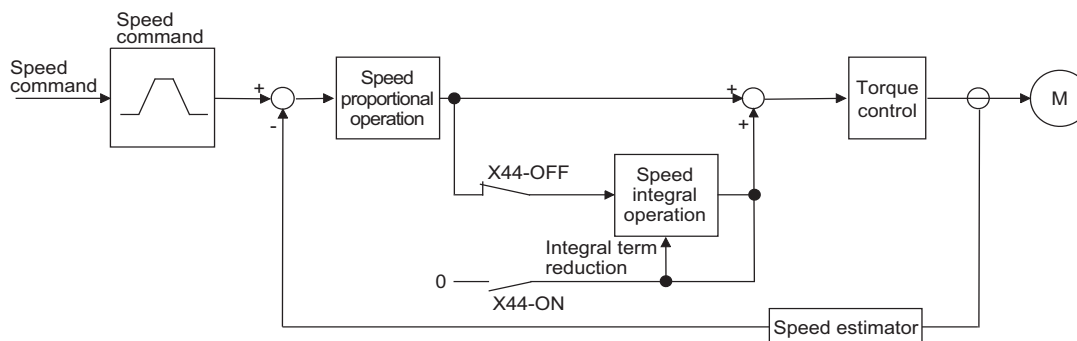

#### NOTE

- Changing the terminal assignment using **Pr.178 to Pr.189 (Input terminal function selection)** may affect the other functions. Set parameters after confirming the function of each terminal.
- The speed loop integration can be disabled at the emergency stop using **Pr.1349 Emergency stop operation selection**. (Refer to [page 367](#).)

### ◆ P/PI control switchover according to the motor speed (Pr.1348)

- When the motor speed falls below the **Pr.1348** setting during speed control under Real sensorless vector control or Vector control, speed loop integration is stopped and the accumulated integral term is cleared.

**Pr.1348** setting or more: PI control

Less than the **Pr.1348** setting: P control

- The shock of P/PI control switchover is absorbed by setting **Pr.1115 Speed control integral term clear time**. When the motor speed falls below the **Pr.1348** setting, speed loop integration is stopped and the accumulated integral term is reduced and cleared according to the **Pr.1115** setting (initial value is 0 ms). In **Pr.1115**, set time when the integral term is reduced from 100% to 0% regarding the rated torque current (I<sub>q</sub>) as 100%. When the motor speed is increased to the **Pr.1348** setting plus 2 Hz or more, integral operation is resumed.

#### NOTE

- The speed loop integration can be disabled at the emergency stop using **Pr.1349 Emergency stop operation selection**. (Refer to [page 367](#).)

## 5.3.6 Troubleshooting in the speed control

Sensorless Vector PM

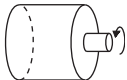
No.	Condition	Possible cause	Countermeasure
1	The motor does not rotate. (Vector control)	Motor wiring is incorrect.	<ul style="list-style-type: none"> <li>Check the wiring. Set V/F control (set <b>Pr.80 Motor capacity</b> or <b>Pr.81 Number of motor poles</b> to "9999") and check the motor rotation direction. For SF-V5RU (1500 r/min series), set <b>Pr.19 Base frequency voltage</b> to 170 V (340 V) when the value is 3.7 kW or lower, and set it to 160 V (320 V) when the value is higher, and set <b>Pr.3 Base frequency</b> to 50 Hz.</li> <li>When a forward signal is input, rotation in the counterclockwise direction as viewed from the motor shaft direction is correct. (Clockwise rotation means that the phase sequence of the inverter secondary side wiring is different.)</li> </ul> 
		Encoder type selection switch (Vector control compatible option) is incorrect.	<ul style="list-style-type: none"> <li>Check the encoder specifications. Check the encoder type selection switch of differential/complementary (Vector control compatible option).</li> </ul>
		The wiring of the encoder is incorrect.	<ul style="list-style-type: none"> <li>When using the system where the motor shaft can be rotated by an external force other than the motor without any safety troubles at Vector control setting, rotate the motor counterclockwise and check if FWD is indicated. If REV is indicated, the phase sequence of the encoder is incorrect. Check the wiring, and set <b>Pr.359 (Pr.852) Encoder rotation direction</b> in accordance with the motor specification. (Refer to <a href="#">page 87.</a>) If the clockwise direction is forward as viewed from the motor shaft side, set <b>Pr.359(Pr.852) = "0"</b>. If the counterclockwise direction is forward as viewed from the motor shaft side, set <b>Pr.359 (Pr.852) = "1"</b>.</li> </ul>
		The parameter setting and the number of encoder pulses used are different.	<ul style="list-style-type: none"> <li>If the parameter setting value is lower than the number of encoder pulses used, the motor does not rotate. Set <b>Pr.369 (Pr.852) Number of encoder pulses</b> correctly. (Refer to <a href="#">page 87.</a>)</li> </ul>
		Encoder power specifications are incorrect. Alternatively, power is not input.	<ul style="list-style-type: none"> <li>Check the encoder power specifications (5 V/12 V/15 V/24 V), and input the external power supply. When the encoder output is the differential line driver type, only 5 V can be input. Make the voltage of the external power supply same as the encoder output voltage, and connect the external power supply between PG and SD.</li> </ul>
		The option to be used and parameter settings do not match.	<ul style="list-style-type: none"> <li>Correctly set <b>Pr.862 Encoder option selection</b> according to the option to be used. (Refer to <a href="#">page 226.</a>)</li> </ul>
2	Motor does not run at the correct speed. (Command speed and actual speed differ.)	Speed command from the controller is different from the actual speed. The speed command is affected by noise.	<ul style="list-style-type: none"> <li>Check that the speed command sent from the controller is correct. (Take EMC measures.)</li> <li>Lower the setting of <b>Pr.72 PWM frequency selection</b>.</li> </ul>
		The command speed and the speed recognized by the inverter are different.	<ul style="list-style-type: none"> <li>Adjust the bias and gain <b>Pr.125, Pr.126, C2 to C7, C12 to C15</b> of the speed command again.</li> </ul>
		The setting for the number of encoder pulses is incorrect.	<ul style="list-style-type: none"> <li>Check the settings of <b>Pr.369 (Pr.851)</b> (under Vector control). (Refer to <a href="#">page 87.</a>)</li> </ul>
		The motor constant varies due to increase in the motor temperature.	<ul style="list-style-type: none"> <li>Enable the online auto tuning at startup (set <b>Pr.95 (Pr.574) = "1"</b>) (under Real sensorless vector control). (Refer to <a href="#">page 558.</a>) To perform the online auto tuning at startup for a lift, use of the Start-time tuning start external input (X28) signal is recommended.</li> </ul>
3	The speed does not accelerate to the command speed.	Torque shortage. The torque limit is operating.	<ul style="list-style-type: none"> <li>Raise the torque limit. (Refer to the torque limit for speed control on <a href="#">page 245.</a>)</li> <li>Increase the capacity.</li> </ul>
		Only P (proportional) control is performed.	<ul style="list-style-type: none"> <li>Speed deviation occurs under P (proportional) control when the load is heavy. Select PI control.</li> </ul>

No.	Condition	Possible cause	Countermeasure
4	Motor speed fluctuates.	Speed command varies.	<ul style="list-style-type: none"> <li>• Check that the speed command sent from the controller is correct. (Take EMC measures.)</li> <li>• Set <b>Pr.72</b> lower.</li> <li>• Set <b>Pr.822 Speed setting filter 1</b> higher. (Refer to <a href="#">page 503</a>.)</li> </ul>
		Torque shortage.	<ul style="list-style-type: none"> <li>• Raise the torque limit. (Refer to the torque limit for speed control on <a href="#">page 245</a>.)</li> </ul>
		Speed control gain is not suitable for the machine. (Resonance occurs.)	<ul style="list-style-type: none"> <li>• Perform easy gain tuning.</li> <li>• Adjust <b>Pr.820 Speed control P gain 1</b> and <b>Pr.821 Speed control integral time 1</b>.</li> <li>• Perform speed feed forward control or model adaptive speed control.</li> </ul>
5	Hunting (vibration or acoustic noise) occurs in the motor or the machine.	Speed control gain is too high.	<ul style="list-style-type: none"> <li>• Perform easy gain tuning.</li> <li>• Set <b>Pr.820</b> lower and <b>Pr.821</b> higher.</li> <li>• Perform speed feed forward control or model adaptive speed control.</li> </ul>
		Torque control gain is too high.	<ul style="list-style-type: none"> <li>• Set <b>Pr.824 Torque control P gain 1 (current loop proportional gain)</b> lower.</li> </ul>
		Motor wiring is incorrect.	<ul style="list-style-type: none"> <li>• Check the wiring.</li> </ul>
6	Acceleration/ deceleration time is different from the setting.	Torque shortage.	<ul style="list-style-type: none"> <li>• Raise the torque limit. (Refer to the torque limit for speed control on <a href="#">page 245</a>.)</li> <li>• Perform speed feed forward control.</li> </ul>
		Load inertia is too high.	<ul style="list-style-type: none"> <li>• Set acceleration/deceleration time suitable for the load.</li> </ul>
7	Machine movement is unstable.	Speed control gain is not suitable for the machine.	<ul style="list-style-type: none"> <li>• Perform easy gain tuning.</li> <li>• Adjust <b>Pr.820</b> and <b>Pr.821</b>.</li> <li>• Perform speed feed forward control or model adaptive speed control.</li> </ul>
		Response is slow because of the inverter's acceleration/ deceleration time setting.	<ul style="list-style-type: none"> <li>• Set the optimum acceleration/deceleration time.</li> </ul>
8	Rotation ripple occurs during the low-speed operation.	High carrier frequency is affecting the motor rotation.	<ul style="list-style-type: none"> <li>• Set <b>Pr.72</b> lower.</li> </ul>
		Speed control gain is too low.	<ul style="list-style-type: none"> <li>• Set <b>Pr.820</b> higher.</li> </ul>

#### «Parameters referred to»

Pr.3 Base frequency, Pr.19 Base frequency voltage [page 707](#)

Pr.72 PWM frequency selection [page 356](#)

Pr.80 Motor capacity, Pr.81 Number of motor poles [page 221](#)

Pr.125 Terminal 2 frequency setting gain frequency, Pr.126 Terminal 4 frequency setting gain frequency [page 505](#)

Pr.359 Encoder rotation direction, Pr.369 Number of encoder pulses, Pr.851 Control terminal option-Number of encoder pulses, Pr.852 Control terminal option-Encoder rotation direction [page 87](#)

Pr.822 Speed setting filter 1 [page 503](#)

Pr.824 Torque control P gain 1 (current loop proportional gain) [page 294](#)

# 5.3.7 Speed feed forward control, model adaptive speed control

Sensorless Vector PM

- Speed feed forward control or model adaptive speed control can be selected using parameter settings. Under speed feed forward control, the motor trackability for speed command changes can be improved. Under model adaptive speed control, the speed trackability and the response level to motor external disturbance torque can be adjusted individually.

Pr.	Name	Initial value	Setting range	Description
828 G224	Model speed control gain	60%	0 to 1000%	Set the gain for the model speed controller.
877 G220	Speed feed forward control/model adaptive speed control selection	0	0 1 2	Perform normal speed control. Perform speed feed forward control. Model adaptive speed control becomes valid.
878 G221	Speed feed forward filter	0 s	0 to 1 s	Set the primary delay filter for the result of the speed feed forward calculated from the speed command and load inertia ratio.
879 G222	Speed feed forward torque limit	150%	0 to 400%	Set a maximum limit for the speed feed forward torque.
880 C114	Load inertia ratio	7-fold	0 to 200-fold	Set the load inertia ratio for the motor.
881 G223	Speed feed forward gain	0%	0 to 1000%	Set the calculation result for speed feed forward as the gain.
1119 G262	Model speed control gain (per-unit system)	9999	0 to 300 9999	Set the gain for the model speed controller in the per-unit system. The Pr.828 setting is applied to the operation.
1121 G260	Per-unit speed control reference frequency	120 Hz <sup>*1</sup> 60 Hz <sup>*2</sup>	0 to 400 Hz	Set the speed at 100% when setting speed control P gain or model speed control gain in the per-unit system.

\*1 For the FR-A820-03160(55K) or lower, and FR-A840-01800(55K) or lower.  
\*2 For the FR-A820-03800(75K) or higher, and FR-A840-02160(75K) or higher.

**Point**

- When using model adaptive speed control, use the data obtained from the easy gain tuning for **Pr.828 Model speed control gain** setting. Make the setting with easy gain tuning (at the same time). (Refer to [page 254](#).)

## ◆ Speed feed forward control (Pr.877 = "1")

- When the load inertia ratio is set in **Pr.880**, the required torque for the set inertia is calculated according to the acceleration and deceleration commands, and the torque is generated quickly.
- When the speed feed forward gain is 100%, the calculation result for speed feed forward is applied as is.
- If the speed command changes suddenly, the torque is increased by the speed feed forward calculation. The maximum limit for the speed feed forward torque is set in **Pr.879**.
- The speed feed forward result can also be lessened with a primary delay filter in **Pr.878**.

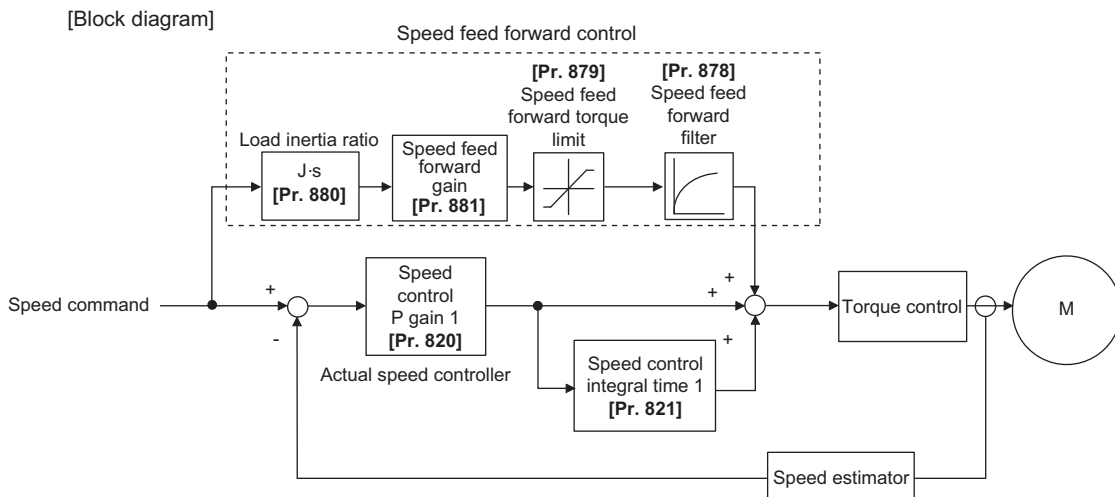

**NOTE**

- The speed feed forward control is enabled for the first motor.
- Even if the driven motor is switched to the second motor while **Pr.877** = "1", the second motor is operated as **Pr.877** = "0".
- Under PM sensorless vector control, the notch filter is available when low-speed range high-torque characteristic is enabled by **Pr.788 Low speed range torque characteristic selection** = "9999 (initial value)". (Refer to [page 233.](#))

**◆ Model adaptive speed control (Pr.877 = "2", Pr.828, Pr.1119)**

- The model speed of the motor is calculated, and the feedback is applied to the speed controller on the model side. Also, this model speed is set as the command of the actual speed controller.
- The inertia ratio of **Pr.880** is used when the speed controller on the model side calculates the torque current command value.
- The torque current command of the speed controller on the model side is added to the output of the actual speed controller, and set as the input of the iq current control.

**Pr.828** is used for the speed control on the model side (P control), and first gain **Pr.820** is used for the actual speed controller.

- The model speed control gain can be set in the per-unit (pu) system in **Pr.1119**.
- In the per-unit system:

When "1" is set, the torque (Iq) command is 100% (rated Iq) when the speed deviation is 100%.

When "1" is set, the torque (Iq) command is 100% (rated Iq) when the speed deviation is 100%.

Set the 100% speed in **Pr.1121 Per-unit speed control reference frequency**.

[Block diagram]

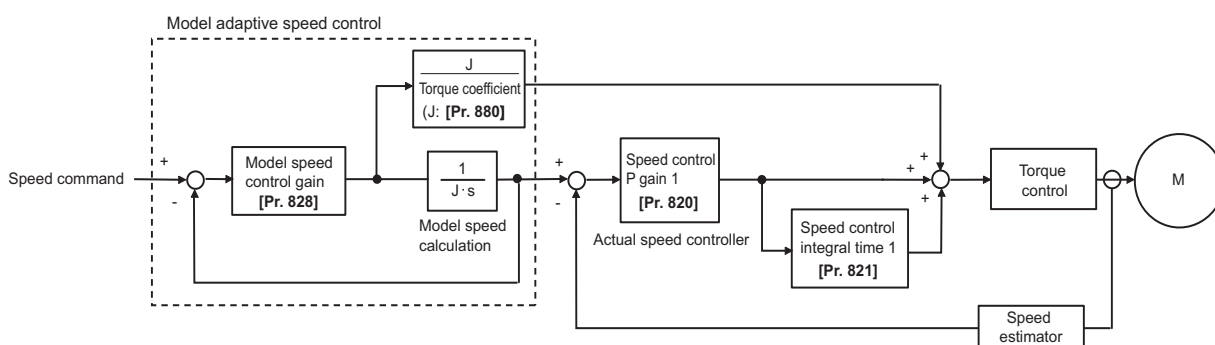

**NOTE**

- The model adaptive speed control is enabled for the first motor.
- Even if the driven motor is switched to the second motor while **Pr.877** = "2", the second motor is operated as **Pr.877** = "0".
- Under PM sensorless vector control, the notch filter is available when low-speed range high-torque characteristic is enabled by **Pr.788 Low speed range torque characteristic selection** = "9999 (initial value)". (Refer to [page 233.](#))
- Under model adaptive speed control, because the appropriate gain values for the model and actual loop sections are based on the response that was set for easy gain tuning, when raising the response level, **Pr.818 Easy gain tuning response level setting** must be re-evaluated (raised).
- The per-unit system setting (**Pr.1119**) is available only under Real sensorless vector control or Vector control.
- When the speed control P gain or model speed control gain is set in the per-unit system, the easy gain tuning selection (**Pr.819** = "1 or 2") becomes invalid.

## ◆ Combining with easy gain tuning

- The following table shows the relationship between speed feed forward and model adaptive speed control, and the easy gain tuning function.

	Easy gain tuning selection (Pr.819) setting		
	0	1	2
Pr.880 Load inertia ratio .	Manual input	The inertia ratio value calculated by easy gain tuning is displayed. Manual input is available only during a stop.	Manual input
Pr.820 Speed control P gain 1	Manual input	The tuning result is displayed. Write is not available.	The tuning result is displayed. Write is not available.
Pr.821 Speed control integral time 1	Manual input	The tuning result is displayed. Write is not available.	The tuning result is displayed. Write is not available.
Pr.828 Model speed control gain	Manual input	The tuning result is displayed. Write is not available.	The tuning result is displayed. Write is not available.
Pr.881 Speed feed forward gain	Manual input	Manual input	Manual input

### Parameters referred to

Pr.820 Speed control P gain 1, Pr.830 Speed control P gain 2 [page 254](#)  
 Pr.821 Speed control integral time 1, Pr.831 Speed control integral time 2 [page 254](#)  
 Pr.788 Low speed range torque characteristic selection [page 233](#)

## 5.3.8 Torque bias

**Sensorless** **Vector**

The torque bias function can be used to make the starting torque start-up faster. At this time, the motor starting torque can be adjusted with a contact signal or analog signal.

Pr.	Name	Initial value	Setting range	Description
840 G230	Torque bias selection	9999	0	Set the torque bias amount using contact signals (X42, X43) in <b>Pr.841 to Pr.843</b> .
			1	Set the torque bias amount using terminal 1 in any of <b>C16 to C19</b> . (When the squirrel cage rises during forward motor rotation.)
			2	Set the torque bias amount using terminal 1 in any of <b>C16 to C19</b> . (When the squirrel cage rises during reverse motor rotation.)
			3	The torque bias amount using terminal 1 can be set automatically in <b>C16 to C19</b> and <b>Pr.846</b> according to the load.
			24	Torque bias command via PROFIBUS-DP communication (FR-A8NP) (-400% to 400%)
			25	Torque bias command via PROFIBUS-DP communication (FR-A8NP) (-327.68% to 327.67%)
			9999	No torque bias, rated torque 100%
841 G231	Torque bias 1	9999	600 to 999%	Negative torque bias amount (-400% to -1%)
842 G232	Torque bias 2		1000 to 1400%	Positive torque bias amount (0 to 400%)
843 G233	Torque bias 3		9999	No torque bias setting
844 G234	Torque bias filter	9999	0 to 5 s	The time until the torque starts up.
			9999	The same operation as 0 s.
845 G235	Torque bias operation time	9999	0 to 5 s	The time for retaining the torque of the torque bias amount.
			9999	The same operation as 0 s.
846 G236	Torque bias balance compensation	9999	0 to 10 V	Set the voltage for the balanced load.
			9999	The same operation as 0 V. (Fixed to 0 V/0%.)
847 G237	Fall-time torque bias terminal 1 bias	9999	0 to 400%	The bias value setting in the torque command.
			9999	The same as ( <b>C16, C17 (Pr.919)</b> ) when ascending
848 G238	Fall-time torque bias terminal 1 gain	9999	0 to 400%	The gain value setting in the torque command.
			9999	The same as ( <b>C18, C19 (Pr.920)</b> ) when ascending

## ◆ Block diagram

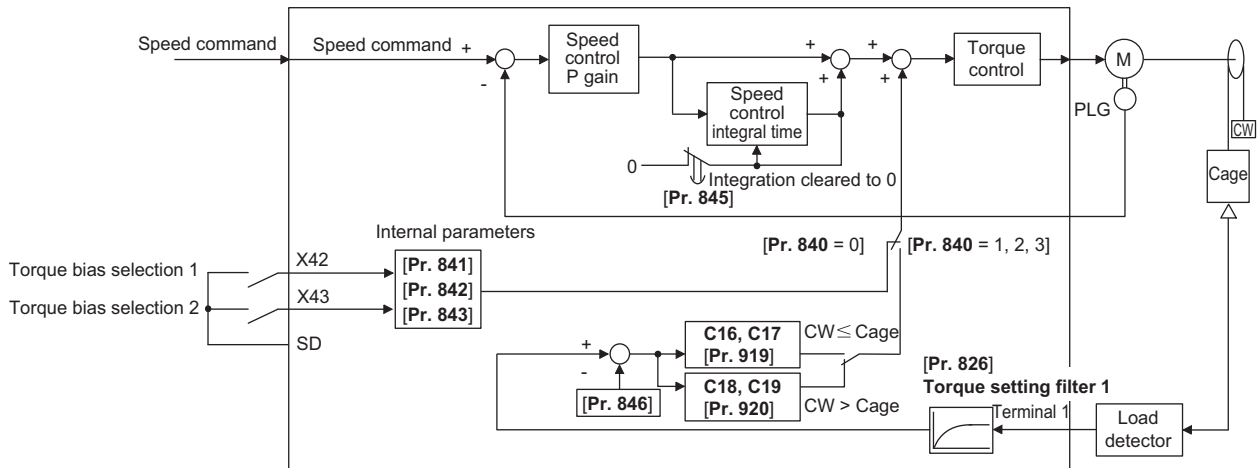

## ◆ Setting the torque bias amount using contact input (Pr.840 = "0", Pr.841 to Pr.843)

- Select the torque bias amount shown in the following table using the corresponding contact signal combination.
- To input the X42 signal, set "42" in any of **Pr.178 to Pr.189 (Input terminal function selection)** to assign the function to a terminal, and to input the X43 signal, set "43".

Torque bias selection 1 (X42)	Torque bias selection 2 (X43)	Torque bias amount
OFF	OFF	0%
ON	OFF	<b>Pr.841</b> -400% to +400% (Setting value: 600 to 1400%)
OFF	ON	<b>Pr.842</b> -400% to +400% (Setting value: 600 to 1400%)
ON	ON	<b>Pr.843</b> -400% to +400% (Setting value: 600 to 1400%)

When **Pr.841** = "1025", the torque bias is 25%. When **Pr.842** = "975", the torque bias is -25%. When **Pr.843** = "925", the torque bias is -75%.

### NOTE

- Changing the terminal assignment using **Pr.178 to Pr.189 (Input terminal function selection)** may affect the other functions. Set parameters after confirming the function of each terminal.

## ◆ Setting the torque bias amount using terminal 1 (Pr.840 = "1, 2", Pr.847, Pr.848)

- Calculate the torque bias from the load input to terminal 1 as shown in the following diagram, and then apply the torque bias.
- To set the torque bias amount with a voltage input to terminal 1, set **Pr.868 Terminal 1 function assignment** = "6".

- The torque bias amount (**Pr.847**) and gain amount (**Pr.848**) when descending (reverse motor rotation when the **Pr.840** setting is "1", forward motor rotation when the setting is "2") can be set in a range of 0 to 400%. When **Pr.847** or **Pr.848** = "9999", the setting is the same for both descending and ascending (**C16 to C19**).

Pr.840 setting	When ascending	When descending
1	<p>(Forward motor rotation)</p> <p>Bias amount</p> <p>Torque command terminal 1 gain <b>C18(Pr.920)</b></p> <p>Torque command terminal 1 bias <b>C16(Pr.919)</b></p> <p>Voltage for balanced load <b>Pr.846</b></p> <p>Voltage for max. load <b>C19(Pr.920)</b></p> <p>Terminal 1 input</p>	<p>(Reverse motor rotation)</p> <p>Bias amount</p> <p>Fall-time torque bias terminal 1 bias <b>Pr.848</b></p> <p>Fall-time torque bias terminal 1 gain <b>Pr.847</b></p> <p>Voltage for balanced load <b>Pr.846</b></p> <p>Voltage for max. load <b>C19(Pr.920)</b></p> <p>Terminal 1 input</p>
2	<p>(Reverse motor rotation)</p> <p>Bias amount</p> <p>Torque command terminal 1 bias <b>C16(Pr.919)</b></p> <p>Torque command terminal 1 gain <b>C18(Pr.920)</b></p> <p>Voltage for balanced load <b>Pr.846</b></p> <p>Voltage for max. load <b>C19(Pr.920)</b></p> <p>Terminal 1 input</p>	<p>(Forward motor rotation)</p> <p>Bias amount</p> <p>Fall-time torque bias terminal 1 bias <b>Pr.847</b></p> <p>Fall-time torque bias terminal 1 gain <b>Pr.848</b></p> <p>Voltage for balanced load <b>Pr.846</b></p> <p>Voltage for max. load <b>C19(Pr.920)</b></p> <p>Terminal 1 input</p>

#### NOTE

- Input 0 to 10 V (torque command) to the terminal 1 that is used for the torque bias function. Any negative input voltage is regarded as 0 V.

### ◆ Setting the torque bias amount automatically using terminal 1 (Pr.840 = "3", Pr.846)

- The settings of **C16 Terminal 1 bias command (torque/magnetic flux)**, **C17 Terminal 1 bias (torque/magnetic flux)**, **C18 Terminal 1 gain command (torque/magnetic flux)**, **C19 Terminal 1 gain (torque/magnetic flux)** and **Pr.846 Torque bias balance compensation** can be set automatically according to the load.
- To set the torque bias amount with a voltage input to terminal 1, set **Pr.868 Terminal 1 function assignment = "6"**.



- Set the terminal 1 to accept inputs of load detection voltage, set "3" in **Pr.840 Torque bias selection**, and adjust the parameter settings according to the following procedures.

#### Setting C16, C17 (Pr.919)

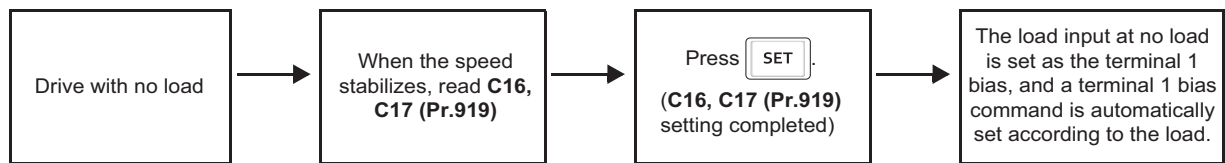

#### Setting C18, C19 (Pr.920)

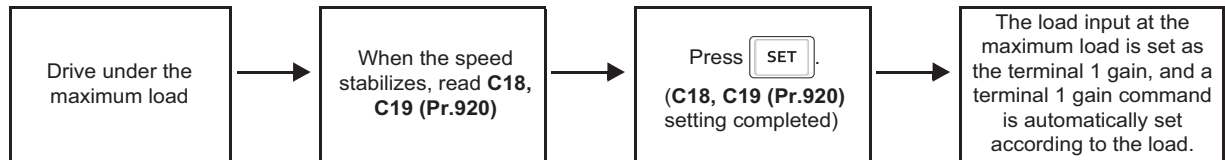

#### Setting Pr.846

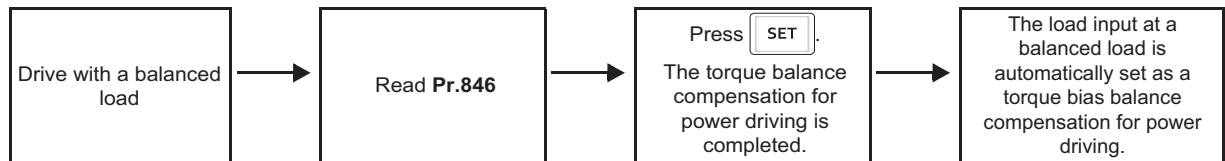

#### NOTE

- To perform a torque bias operation after the automatic setting is completed, set **Pr.840** to "1" or "2".

### ◆ Torque bias command via PROFIBUS-DP communication (Pr.840 = "24 or 25")

- A torque bias command value can be set using the FR-A8NP (PROFIBUS-DP communication).

Pr.840 setting	Method to give torque bias command	Setting range	Setting increments
24	Torque bias command from the buffer memory of PROFIBUS (REF1 to 7)	600 to 1400 (-400% to 400%)	1%
25	Torque bias command from the buffer memory of PROFIBUS (REF1 to 7)	-32768 to 32767 (two's complement) (-327.68% to 327.67%)	0.01%

#### NOTE

- For details on the FR-A8NP setting, refer to the Instruction Manual of the FR-A8NP.

### ◆ Torque bias operation (Pr.844, Pr.845)

- The torque start-up can be made slower by setting **Pr.844 Torque bias filter** ≠ "9999". The torque start-up operation at this time is the time constant of the primary delay filter.

- Set the time for continuing the output torque simply by using the command value for the torque bias in **Pr.845 Torque bias operation time**.

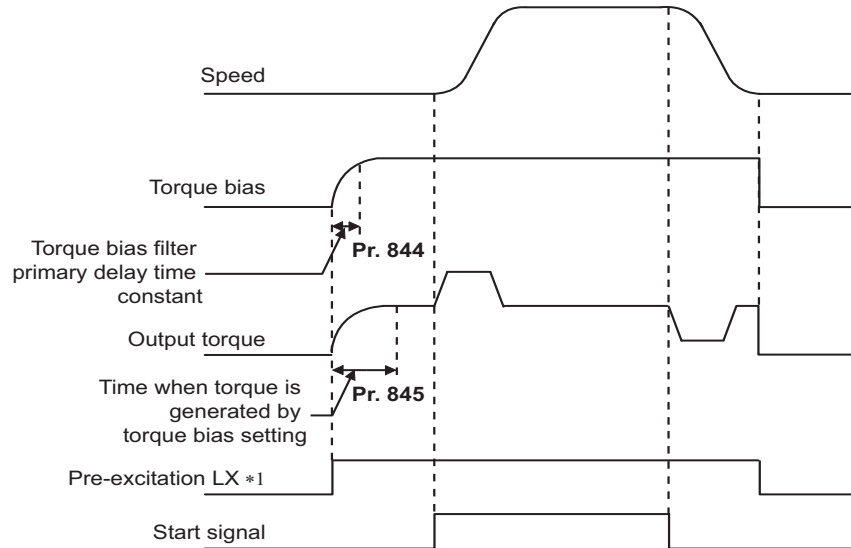

\*1 When pre-excitation is not performed, the torque bias functions at the same time as the start signal.

### NOTE

- When torque bias is enabled and **Pr.868** = "6", terminal 1 operates as a torque command instead of a frequency setting auxiliary. When override compensation is selected using **Pr.73 Analog input selection** and terminal 1 is the main speed, no main speed (main speed = 0 Hz) is set.
- The torque bias is valid for the first motor. When applying the second motor (RT signal is ON), the torque bias function is not performed.
- Changing the terminal assignment using **Pr.178 to Pr.189 (Input terminal function selection)** may affect the other functions. Set parameters after confirming the function of each terminal.

### Parameters referred to

Pr.73 Analog input selection [page 496](#)  
 Pr.178 to Pr.189 (Input terminal function selection) [page 521](#)  
 C16 to C19 (Pr.919, Pr.920) (torque setting voltage (current) bias/gain) [page 510](#)

## 5.3.9 Avoiding motor overrunning

### Vector

Motor overrunning due to excessive load torque or an error in the setting of the number of encoder pulses can be avoided.

Pr.	Name	Initial value	Setting range	Description
285 H416	Speed deviation excess detection frequency <sup>*1</sup>	9999	0 to 30 Hz	Set the speed deviation excess detection frequency (difference between the actual rotation speed and speed command value) at which the protective function (E.OSD) activates.
			9999	No speed deviation excess
853 <sup>*2</sup> H417	Speed deviation time	1.0 s	0 to 100 s	Set the time from when the speed deviation excess state is entered to when the protective function (E.OSD) activates.
873 <sup>*2</sup> H415	Speed limit	20 Hz	0 to 400 Hz	Set the frequency limit with the set frequency + <b>Pr.873</b> value.
690 H881	Deceleration check time	1.0 s	0 to 3600 s	Set the time required to shut off output due to deceleration check after the start signal is OFF.
			9999	No deceleration check

\*1 This is the overspeed detection frequency under encoder feedback control. (Refer to [page 736](#).)

\*2 The setting is available when a Vector control compatible option is installed.

### ◆ Speed deviation excess detection (Pr.285, Pr.853)

- A shutoff can be set for when the deviation between the set frequency and actual rotation speed is large, such as when the load torque is excessive.

- When the difference (absolute value) between the speed command value and actual rotation speed in speed control under Vector control is equal to or higher than the setting value in **Pr.285 Speed deviation excess detection frequency** for a continuous time equal to or longer than the setting value in **Pr.853 Speed deviation time**, the speed deviation excess detection (E.OSD) activates to shut off the inverter output.

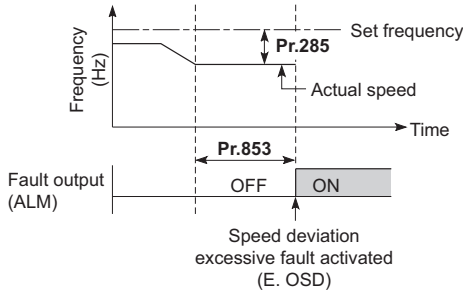

## ◆ Speed limit (Pr.873)

- This function prevents overrunning even when the setting value for and the value of the actual number of pulses are different. When the setting value for the number of encoder pulses is lower than the actual number of pulses, because the motor may increase speed, the output frequency is limited with the frequency of (set frequency + **Pr.873**).

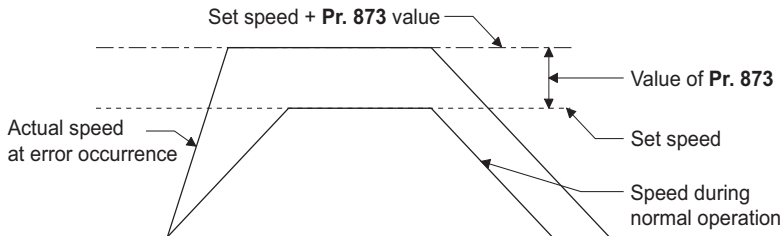

### NOTE

- When the automatic restart after instantaneous power failure function is selected (**Pr.57 Restart coasting time** ≠ "9999") and the setting value for the number of encoder pulses is lower than the actual number of pulses, the output speed is limited with the synchronous speed of the value of **Pr.1 Maximum frequency + Pr.873**.
- When a regenerative driving torque limit is applied and the speed limit function activates, the output torque may drop suddenly. Also, when the speed limit function activates during pre-excitation operation, output phase loss (E.LF) may occur. If the setting for the number of encoder pulses is confirmed as correct, it is recommended that **Pr.873** be set to the maximum value (400 Hz).
- Even if the set frequency is lowered after inverter operation, the speed limit value is not lowered. During deceleration, the speed is limited at frequency command value + **Pr.873**.

## ◆ Deceleration check (Pr.690)

- This function can stop the inverter output when the motor is accelerated accidentally during rotation. This prevents a malfunction due to incorrect encoder pulse settings.
- The function is activated when the difference between the actual motor speed and the speed command value exceeds 2 Hz.
- If the motor does not decelerate within the time period set in **Pr.690**, the speed deviation excess detection (E.OSD) is activated to shut off the inverter output.

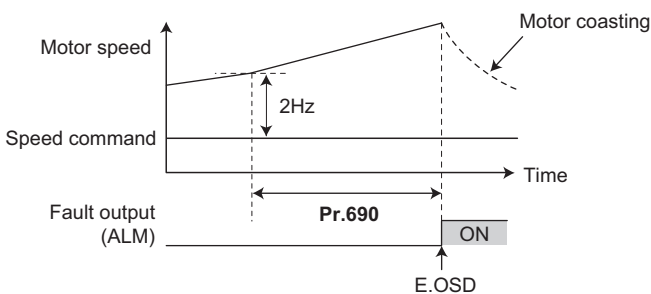

**NOTE**

- The deceleration check is enabled in the speed control of the Vector control.
- If the protective function (E.OSD) operates due to deceleration check, check whether the **Pr.369 Number of encoder pulses** setting is correct.

Parameters referred to

Pr.285 Overspeed detection frequency [page 736](#)

Pr.369 Number of encoder pulses, Pr.851 Control terminal option-Number of encoder pulses [page 94](#)

## 5.3.10 Notch filter

Sensorless Vector PM

The response level of speed control in the resonance frequency band of mechanical systems can be lowered to avoid mechanical resonance.

Pr.	Name	Initial value	Setting range	Description
1003 G601	Notch filter frequency	0	0	No notch filter
			8 to 1250 Hz	Set the frequency for the center of gain attenuation.
1004 G602	Notch filter depth	0	0 to 3	0 (Deep) → 3 (Shallow)
1005 G603	Notch filter width	0	0 to 3	0 (Narrow) → 3 (Wide)

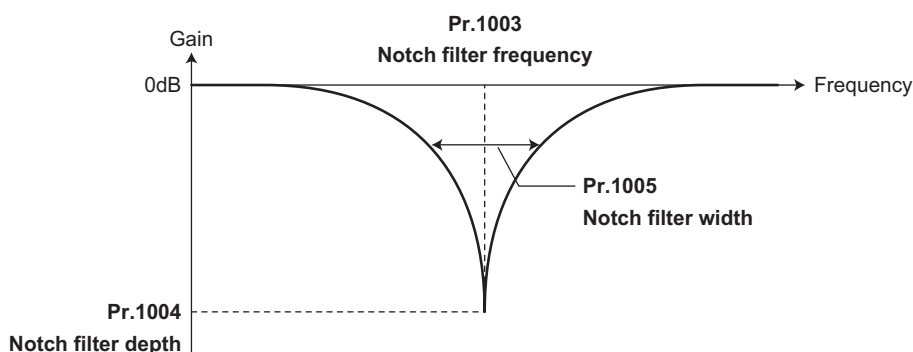

### ◆ Pr.1003 Notch filter frequency

- This sets the frequency for the center when attenuating the gain. If the mechanical resonance frequency is unknown, lower the notch frequency in order from the highest. The point where the resonance is smallest is the optimum setting for the notch frequency.

### ◆ Pr.1004 Notch filter depth

- A deeper notch depth has a greater effect in reducing mechanical resonance, but because the phase delay is larger, swinging may increase. Adjust by starting from the shallowest value.

Setting	3	2	1	0
Gain (depth)	-4 dB (Shallow)	-8 dB	-14dB	-40 dB (Deep)

### ◆ Pr.1005 Notch filter width

- This sets the width of the frequency to which to apply the notch filter. The setting can be adjusted according to the width of the frequency range to be excluded.
- If the width is too wide, the response level of speed control will drop, and the system may become unstable.

**NOTE**

- If a value higher than 500 Hz is set in **Pr.1003** while the response speed is normal (**Pr.800** = any of "0 to 5 and 9 to 14"), the inverter operates at 500 Hz.

Parameters referred to

Pr.800 Control method selection [page 221](#)

## 5.4 Torque control under Real sensorless vector control and Vector control

Purpose	Parameter to set			Refer to page
Torque command source selection or torque command value setting	Torque command	P.D400 to P.D403, P.G210, P.H704	Pr.801, Pr.803 to Pr.806, Pr.1114	283
To prevent the motor from overspeeding	Speed limit	P.H410 to P.H412, P.H414	Pr.807 to Pr.809, Pr.1113	287
To raise precision of torque control	Torque control gain adjustment	P.G213, P.G214, P.G313, P.G314	Pr.824, Pr.825, Pr.834, Pr.835	294
To stabilize torque detection signal	Torque detection filter	P.G216, P.G316	Pr.827, Pr.837	332

### 5.4.1 Torque control

- Under torque control, output torque is controlled to output the torque as commanded.
- Motor rotation speed is steady when the motor output torque and load torque are balanced.  
Thus, motor speed during torque control is determined by the load.
- Under torque control, motor speed accelerates so motor output torque does not exceed motor load.  
In order to prevent the motor from overspeeding, set a speed limit.  
(Speed control is performed instead of torque control during speed limit.)
- If speed limit is not set, speed limit value setting is regarded as 0 Hz and torque control is not enabled.

## ◆ Block diagram

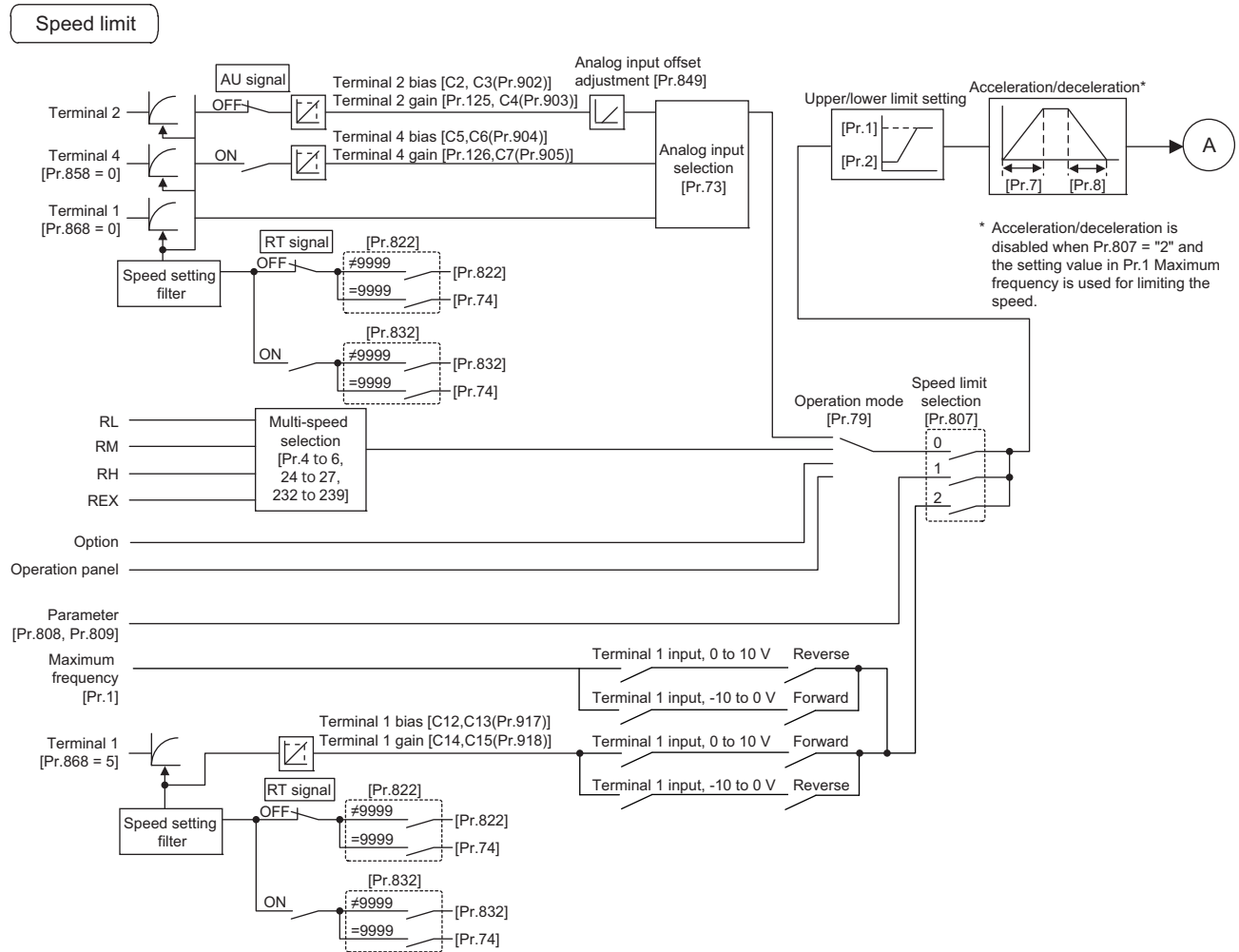

### NOTE

- To select coasting instead of deceleration stop with speed limit when the start command is turned OFF, set **Pr.250 Stop selection**.
- The RT (Second function selection) signal and the X9 (Third function selection) signal are used to enable switching between acceleration/deceleration time settings. The acceleration/deceleration time after switching depends on the settings in **Pr.44 Second acceleration/deceleration time** and **Pr.45 Second deceleration time**, or **Pr.110 Third acceleration/deceleration time** and **Pr.111 Third deceleration time**. The acceleration/deceleration time is a period of time taken to reach **Pr.20 Acceleration/deceleration reference frequency**.
- **Pr.21 Acceleration/deceleration time increments** is used to change the setting increment.
- When the automatic restart after instantaneous power failure is selected, the inverter accelerates the motor from the frequency search result frequency to the set frequency. (**Pr.57 Restart coasting time** ≠ 9999, **Pr.162 Automatic restart after instantaneous power failure selection** = "10, 12, 13, 1010, 1012, or 1013")
- **Pr.811 Set resolution switchover** is used to change the setting increment for speed setting, operation speed monitoring, and torque limit setting.
- **Pr.862 Encoder option selection** is used to change the Vector control compatible plug-in option or the control terminal option for the first and second motors.
- **Pr.1113 Speed limit method selection** is used to change the direction of rotation, torque command polarity, and power driving / regenerative driving status.

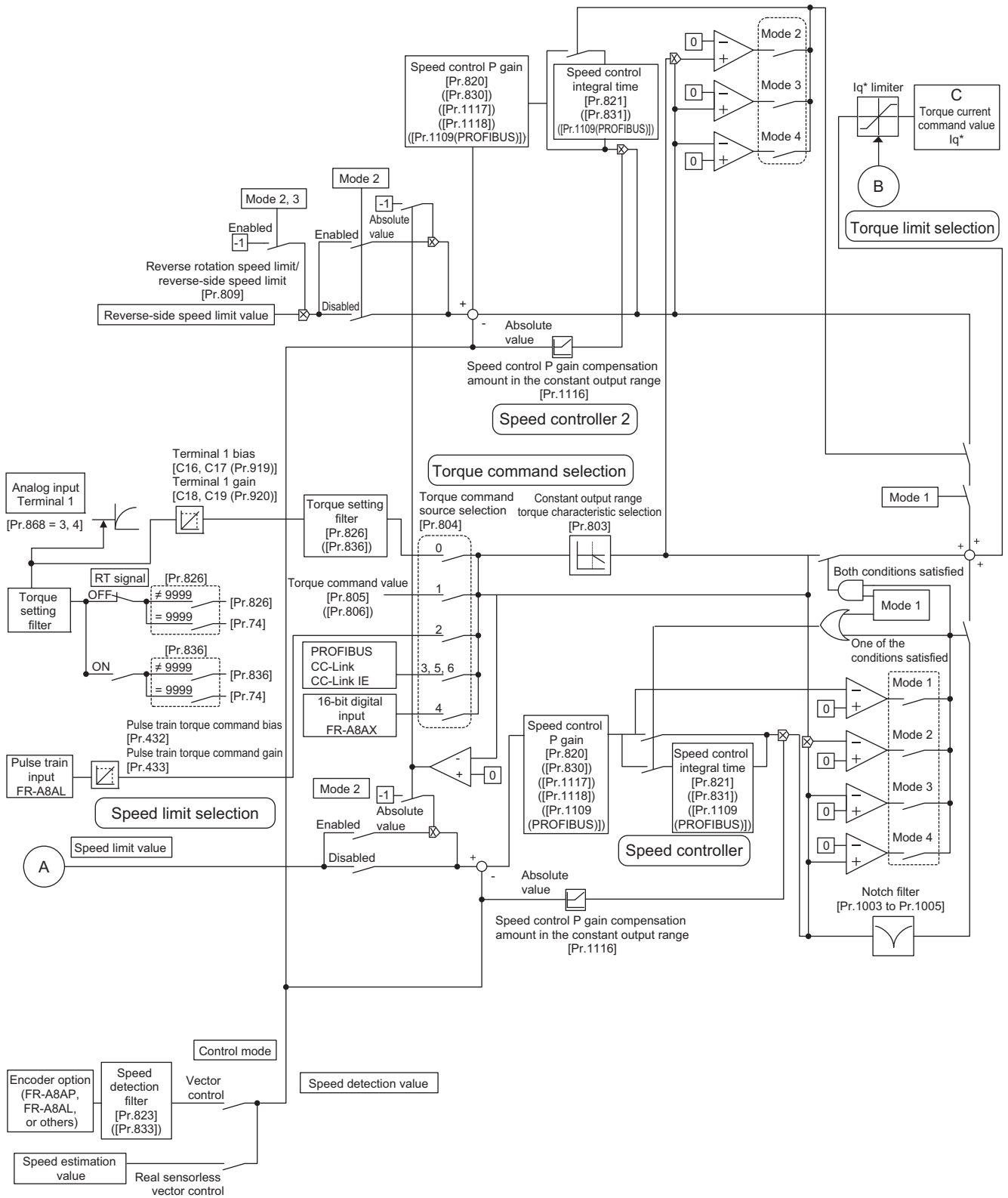

Torque limit selection

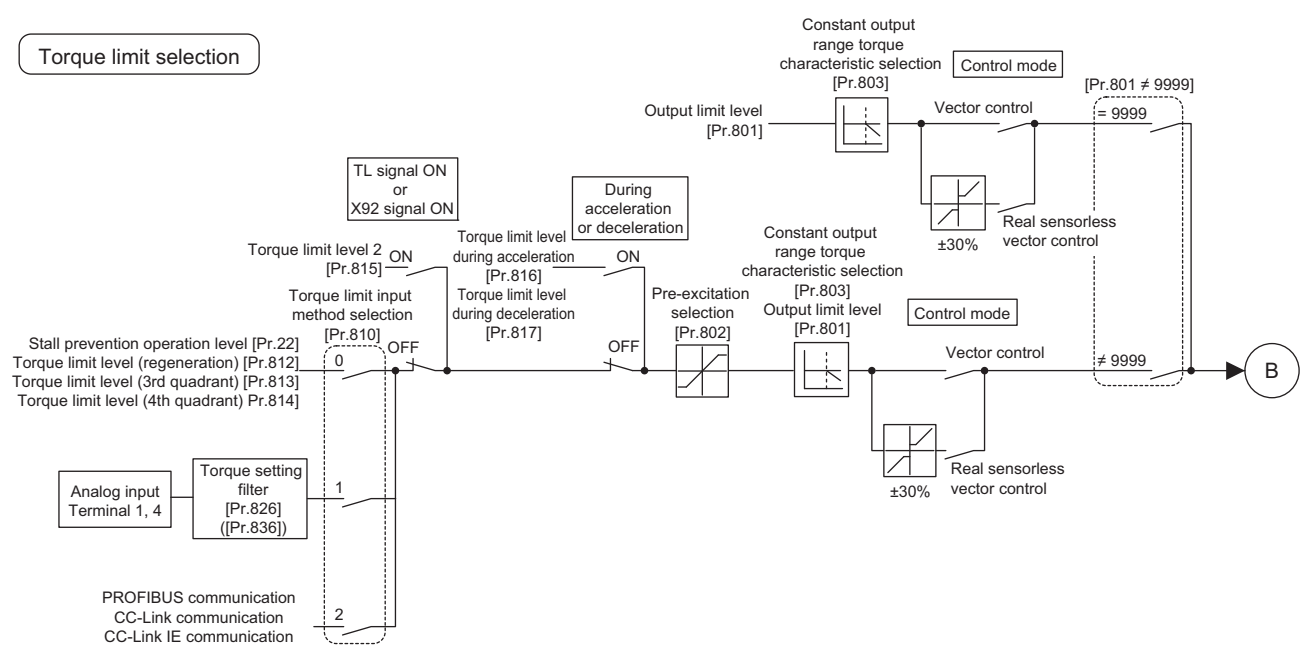





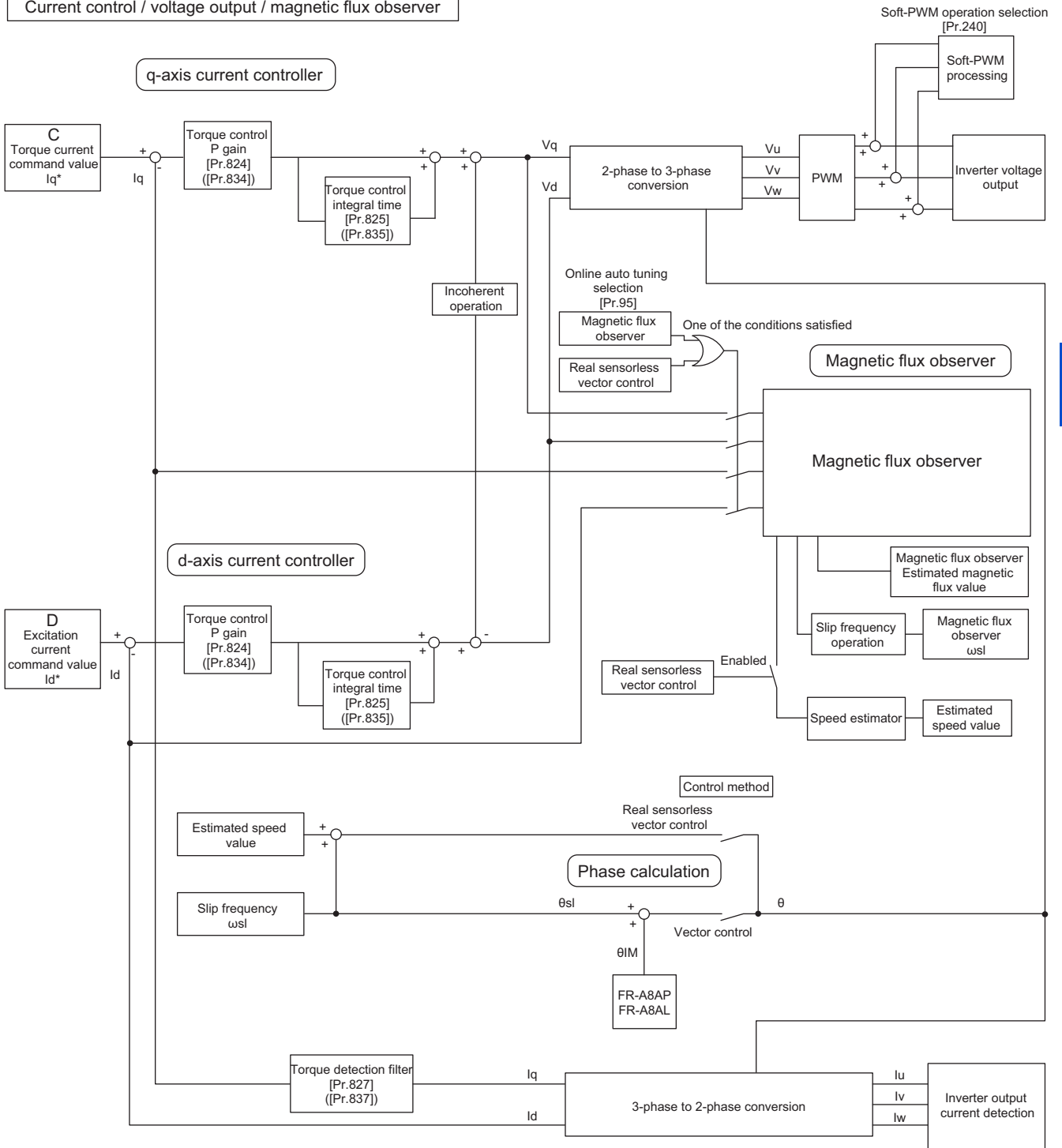

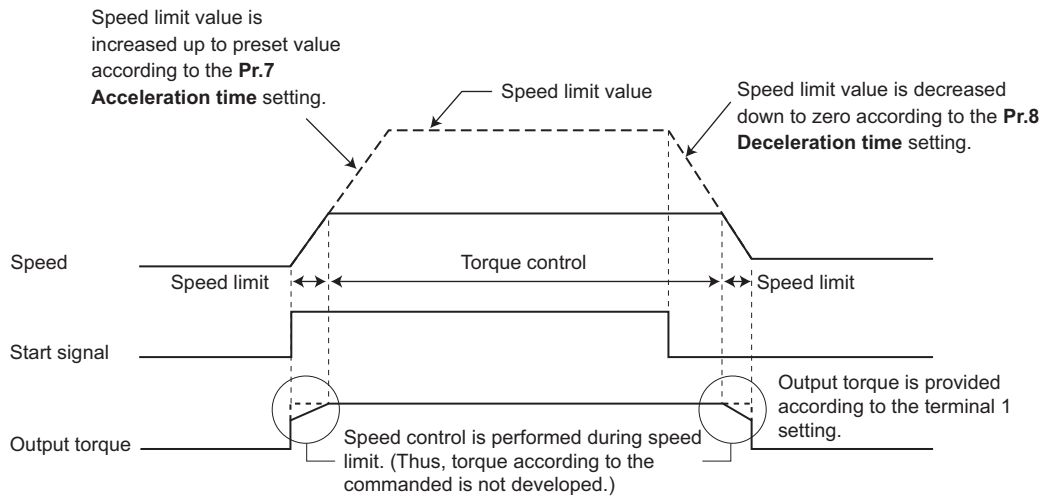

## ◆ Operation transition

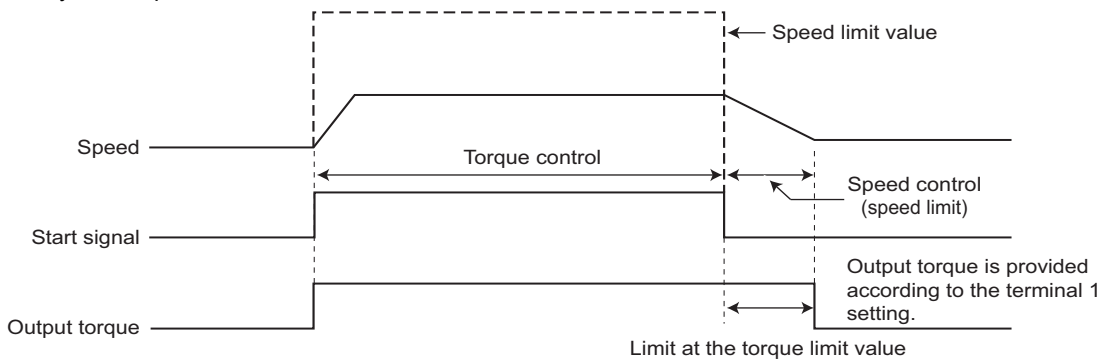

- If the setting value of **Pr.7** and **Pr.8** is "0", turning OFF the start signal enables speed control, and the output torque is controlled by the torque limit value.



Item	Description	
Start signal	External operation	STF, STR signal
	PU operation	 or  of operation panel/ parameter unit
Torque command	Select the method to give the torque command, and give the torque command.	
Speed limit	Select the method to give the speed limit command, and input the speed limit value.	

## ◆ Operation example (when Pr.804 = "0")

Torque control is possible when actual rotation speed does not exceed the speed limit value.

When the actual speed reaches or exceeds the speed limit value, speed limit is activated, torque control is stopped and speed control (proportional control) is performed.

The following diagram indicates operation relative to commands given by analog input via terminal 1.

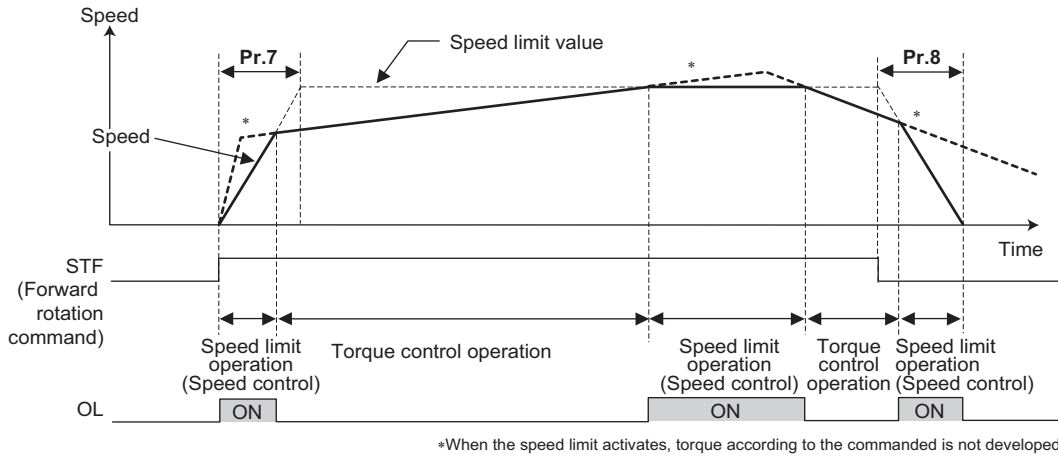

- At the STF signal ON, the speed limit value is raised in accordance with the setting of **Pr.7**.
- Speed control is performed when the actual speed exceeds the speed limit value.
- At the STF signal OFF, the speed limit value is lowered in accordance with the setting of **Pr.8**.
- Under torque control, the actual operation speed is a constant speed when the torque command and load torque are balanced.
- The direction of motor torque generation is determined by a combination of the input torque command polarity and the start signal, as given in the following table.

Polarity of torque command	Torque generation direction	
	STF signal ON	STR signal ON
+ torque command	Forward direction (forward power driving / reverse regenerative driving)	Reverse direction (forward regenerative driving / reverse power driving)
- torque command	Reverse direction (forward regenerative driving / reverse power driving)	Forward direction (forward power driving / reverse regenerative driving)

**NOTE**

- Once the speed limit is activated, speed control is performed and internal torque limit (**Pr.22 Torque limit level**) is enabled. (Initial value) In this case, it may not be possible to return to torque control. Torque limit should be external torque limit (terminals 1 and 4). (Refer to [page 245.](#))
- Under torque control, the undervoltage avoidance function (**Pr.261** = "11" or "12"), which is one of the power failure time deceleration-to-stop function, is invalid. When **Pr.261** = "11 (12)", the operation is performed in the same manner as if **Pr.261** = "1 (2)".
- Under torque control, perform linear acceleration/deceleration (**Pr.29** = "0 (initial value)"). When acceleration/deceleration patterns other than the linear acceleration/deceleration are selected, the protective function of the inverter may be activated. (Refer to [page 372.](#))
- Performing pre-excitation (by using the LX or X13 signal) during torque control (under Real sensorless vector control) may rotate a motor at a low speed even though a start command (STF or STR) is not given. The inverter at a start command ON may also rotate the motor at a low speed even though a speed limit value is set to 0. It must be confirmed that the motor running does not cause any safety problem before performing pre-excitation.

## 5.4.2 Setting procedure of Real sensorless vector control (torque control)

Sensorless

### Operating procedure

1. Perform secure wiring. (Refer to [page 46](#).)
2. Make the motor setting (**Pr.71**). (Refer to [page 528](#).)  
Set **Pr.71 Applied motor** to "0" (standard motor) or "1" (constant-torque motor).
3. Set the motor overheat protection (**Pr.9**). (Refer to [page 415](#).)
4. Set the motor capacity and the number of motor poles (**Pr.80** and **Pr.81**). (Refer to [page 221](#).)  
V/F control is performed when the setting is "9999" (initial value).
5. Set the rated motor voltage and frequency (**Pr.83** and **Pr.84**). (Refer to [page 532](#).)
6. Select the control method (**Pr.800**). (Refer to [page 221](#).)  
Select **Pr.800 Control method selection** = "11" (torque control) or "12" (speed/torque switchover) to enable torque control.
7. Set the torque command (**Pr.804**). (Refer to [page 283](#).)
8. Set the speed limit (**Pr.807**). (Refer to [page 287](#).)
9. Perform the offline auto tuning (**Pr.96**). (Refer to [page 532](#).)
10. Set the acceleration time to "0" (**Pr.7**). (Refer to [page 367](#).)
11. Perform the test operation.

As required

- Select online auto tuning (**Pr.95**). (Refer to [page 558](#).)
- Adjust the torque control gain manually. (Refer to [page 294](#).)

**NOTE**

- During Real sensorless vector control, offline auto tuning must be performed properly before starting operations.
- The carrier frequency is limited during Real sensorless vector control. (Refer to [page 356](#).)
- Torque control is not available in a low-speed (about 10 Hz or lower) regenerative range, or with a low speed and light load (about 5 Hz or lower and rated torque about 20% or lower).
- Performing pre-excitation (LX signal and X13 signal) under torque control may start the motor running at a low speed even when the start signal (STF or STR) is not input. The inverter at a start command ON may also rotate the motor at a low speed even though a speed limit value is set to 0. Confirm that the motor running does not cause any safety problem before performing pre-excitation.
- Switching between the forward rotation command (STF) and reverse rotation command (STR) must not be performed during operations under torque control. An overcurrent trip (E.OC[]) or opposite rotation deceleration fault (E.11) will occur.
- When performing continuous operations under Real sensorless vector control in the FR-A820-00250(3.7K) or lower or FR-A840-00126(3.7K) or lower, the speed fluctuation increases when the value is 20 Hz or less, and in the low-speed range of less than 1 Hz, there may be torque shortage. In such case, stop the inverter and restart it to improve the situation.
- If starting may occur while the motor is coasting under Real sensorless vector control, the frequency search must be set for the automatic restart after instantaneous power failure function (**Pr.57** ≠ "9999", **Pr.162** = "10").
- When Real sensorless vector control is applied, there may not be enough torque provided in the ultra low-speed range of about 2 Hz or lower.

Generally, the speed control range is as follows.

For power driving, 1:200 (2, 4 or 6 poles) (available at 0.3 Hz or higher when the rating is 60 Hz), 1:30 (8 poles or more) (available at 2 Hz or higher when the rating is 60 Hz).

For regenerative driving, 1:12 (2 to 10 poles) (available at 5 Hz or higher when the rating is 60 Hz).

- To give the constant torque command in the constant output range, set "1 or 11" in **Pr.803 Constant output range torque characteristic selection**. (Refer to [page 283](#).)
- For the settings for the SF-V5RU, refer to [page 94](#).

## 5.4.3 Setting procedure for Vector control (torque control)

### Vector

#### Operating procedure

1. Perform secure wiring. (Refer to [page 91](#).)  
Install a Vector control compatible option.
2. Set the option to be used (**Pr.862**).  
Set **Pr.862 Encoder option selection** according to the option to be used. (Refer to [page 226](#).)
3. Set the motor and the encoder (**Pr.71**, **Pr.359 (Pr.852)**, and **Pr.369 (Pr.851)**). (Refer to [page 94](#).)
4. Set the overheat protection of the motor (**Pr.9**). (Refer to [page 415](#).)  
When using the SF-V5RU or a motor equipped with a thermal sensor, set **Pr.9** = 0 A.
5. Set the motor capacity and the number of motor poles (**Pr.80** and **Pr.81**). (Refer to [page 221](#).)  
V/F control is performed when the setting is "9999" (initial value).
6. Set the rated motor voltage and frequency (**Pr.83** and **Pr.84**). (Refer to [page 94](#).)
7. Select the control method (**Pr.800**). (Refer to [page 221](#).)  
Select **Pr.800 Control method selection** = "1" (torque control), "2" (speed/torque switchover), or "5" (position/torque switchover) to enable torque control.
8. Set the torque command (**Pr.804**). (Refer to [page 283](#).)
9. Set the speed limit (**Pr.807**). (Refer to [page 287](#).)
10. Set the acceleration time to "0" (**Pr.7**). (Refer to [page 367](#).)
11. Perform the test operation.

As required

- Perform offline auto tuning (**Pr.96**). (Refer to [page 532](#).)
- Select the online auto tuning (**Pr.95**). (Refer to [page 558](#).)
- Adjust the torque control gain manually. (Refer to [page 294](#).)

#### NOTE

- The carrier frequency is limited during Vector control. (Refer to [page 356](#).)
- Torque control is not available under the Vector control with PM motors.
- To give the constant torque command in the constant output range, set "1 or 11" in **Pr.803 Constant output range torque characteristic selection**. (Refer to [page 283](#).)
- For the settings for the SF-V5RU, refer to [page 94](#).

## 5.4.4 Torque command

Sensorless Vector

For torque control selection, the torque command source can be selected.

Pr.	Name	Initial value	Setting range	Description
432 D120 <sup>*1</sup>	Pulse train torque command bias	0%	0 to 400%	For 0 pulses/s, set the torque to be used during stall prevention operation.
433 D121 <sup>*1</sup>	Pulse train torque command gain	150%	0 to 400%	For 400k pulses/s, set the torque command to be used during stall prevention operation.
801 H704	Output limit level	9999	0 to 400%	Set the torque current limit level.
			9999	The torque limit setting value is used for limiting the torque current level.
803 G210	Constant output range torque characteristic selection	0	0, 10 1, 11 2	Constant motor output command Constant torque command The torque is constant unless the output limit of the torque current is reached. (The torque current is limited.)
				In the torque command setting, select torque command for the constant output area.
804 D400	Torque command source selection	0	0 1 2 3 4 5 6	Torque command given by analog input via terminal 1 Torque command (-400% to 400%) given by the parameter setting (Pr.805 or Pr.806) Torque command given by the pulse train input (FR-A8AL) Torque command through the CC-Link / CC-Link IE Field Network / CC-Link IE TSN communication (FR-A8NC, FR-A8NCE, FR-A800-GF, FR-A8NCG, FR-A800-GN) Torque command given through PROFIBUS-DP communication (FR-A8NP) 12/16-bit digital input (FR-A8AX) Torque command through the CC-Link / CC-Link IE Field Network / CC-Link IE TSN communication (FR-A8NC, FR-A8NCE, FR-A800-GF, FR-A8NCG, FR-A800-GN) Torque command given through PROFIBUS-DP communication (FR-A8NP)
805 D401	Torque command value (RAM)	1000%	600 to 1400%	Writes the torque command value in RAM. Regards 1000% as 0%, and set torque command by an offset of 1000%.
806 D402	Torque command value (RAM, EEPROM)	1000%	600 to 1400%	Writes the torque command value in RAM and EEPROM. Regards 1000% as 0%, and set torque command by an offset of 1000%.
1114 D403	Torque command reverse selection	1	0 1	Not reversed Reversed
				Select whether to reverse the torque command polarity or not when the reverse rotation command (STR) is turned ON.

\*1 The setting is available when the FR-A8AL is installed.

### ◆ Control block diagram

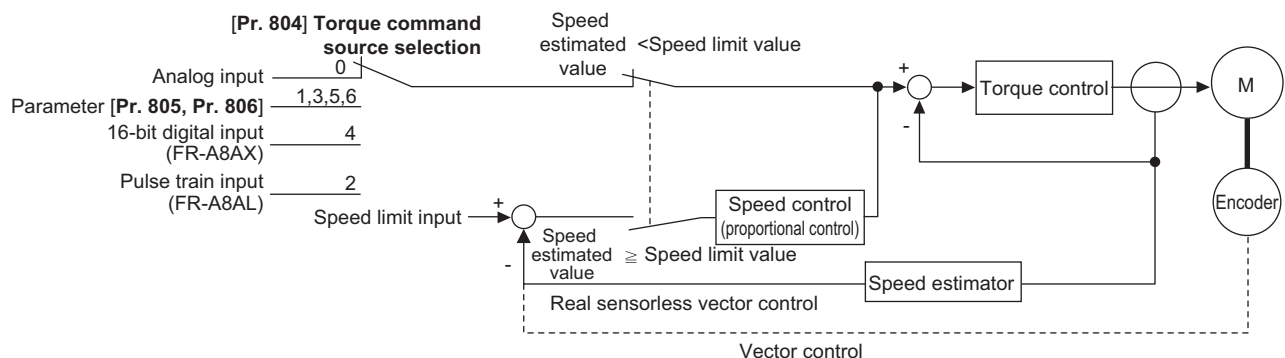

#### NOTE

- When the torque command exceeding the torque limit value (Pr.22, Pr.810, Pr.812 to Pr.817) is given, the output torque is within the torque limit value. (Refer to page 272.)



## ◆ Torque command given by analog input (terminal 1) (Pr.804 = "0 (initial value)")

- Torque commands are given by voltage (current) input via terminal 1.
- Set **Pr.868 Terminal 1 function assignment** = "3 or 4" to give the torque command via terminal 1.
- Torque commands given by analog inputs can be calibrated by the **calibration parameters C16 (Pr.919) to C19 (Pr.920)** (Refer to [page 510.](#))

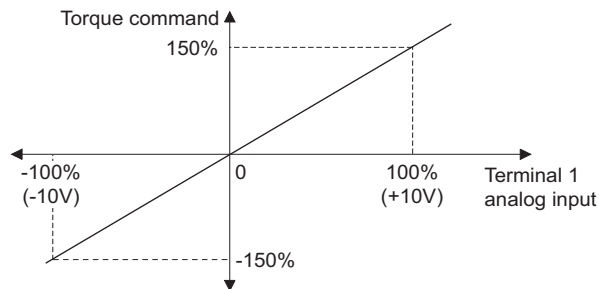

## ◆ Torque command given by parameter (Pr.804 = "1")

- Set **Pr.805 Torque command value (RAM)** or **Pr.806 Torque command value (RAM, EEPROM)** to set the torque command value.  
For **Pr.805** or **Pr.806**, regard 1000% as 0%, and set torque command by offset from 1000%.
- The following diagram shows relation between the **Pr.805** or **Pr.806** setting and the actual torque command value.
- To change the torque command value frequently, write it in **Pr.805**. Writing values in **Pr.806** frequently will shorten the life of the EEPROM.
- When the CC-Link IE Field Network (FR-A8NCE/FR-A800-GF) or CC-Link IE TSN (FR-A8NCG/FR-A800-GN) communication is used, the torque command given from the remote register (RWw2) is valid.

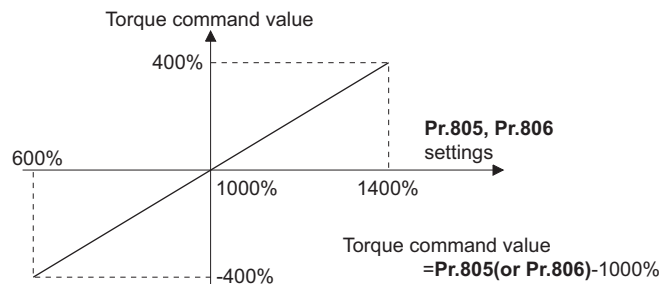







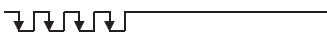
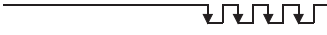

### NOTE

- When the torque command is set by **Pr.805 (RAM)**, powering OFF the inverter erases the changed parameter value. Therefore, the parameter set value is the one saved by **Pr.806 (EEPROM)** when the power is turned back on.
- If giving torque command by parameter setting, set the speed limit value properly to prevent overspeeding. (Refer to [page 287.](#))

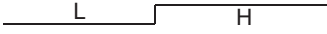
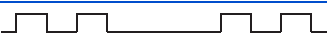
## ◆ Torque command using pulse train (Pr.804 = "2")

- Torque command given by the pulse train input to the FR-A8AL is available.

- Use **Pr.428 Command pulse selection** to select a type of pulse train input to the FR-A8AL.

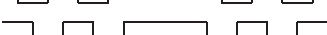
Pr.428 setting	Command pulse train type	During forward rotation	During reverse rotation
0 (initial value)	Forward pulse train Reverse pulse train	PP  NP 	
1	Negative logic	Pulse train + sign	PP  NP 
2		A phase pulse train B phase pulse train	PP  NP 
3	Positive logic	Forward pulse train Reverse pulse train	PP  NP 
4		Pulse train + sign	PP  NP 
5		A phase pulse train B phase pulse train	PP  NP 

- Use **Pr.432 Pulse train torque command bias** and **Pr.433 Pulse train torque command gain** to set the bias and gain values for the torque command respectively.

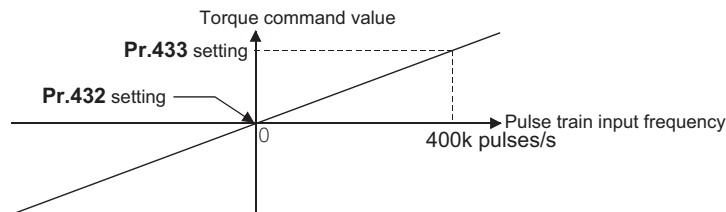

#### NOTE

- For details on the FR-A8AL, refer to the Instruction Manual of the FR-A8AL.

### ◆ Torque command given through the CC-Link / CC-Link IE Field Network / CC-Link IE TSN / PROFIBUS-DP (Pr.804 = "3, 5, 6")

- Set the torque command value through the CC-Link (FR-A8NC/PLC function), CC-Link IE Field Network (FR-A8NCE/FR-A800-GF), CC-Link IE TSN (FR-A8NCG/FR-A800-GN), or PROFIBUS-DP (FR-A8NP) communication.
- For speed limit when "3 or 5" is set in **Pr.804** through the CC-Link communication, **Pr.807 Speed limit selection** becomes invalid and **Pr.808 Forward rotation speed limit/speed limit** and **Pr.809 Reverse rotation speed limit/reverse-side speed limit** become valid. (When **Pr.544 CC-Link extended setting** = "0, 1, 12, 100, or 112")

- For the CC-Link communication, **Pr.807** is valid when the extended cyclic setting of CC-Link communication is quadruple or octuple. For CC-Link IE Field Network or CC-Link IE TSN, **Pr.807** is always valid.

Pr.804 setting	Torque command input			Setting range	Setting increments
	CC-Link/PLC function	CC-Link IE Field Network / CC-Link IE TSN	PROFIBUS-DP		
1	Torque command by <b>Pr.805, Pr.806</b> <sup>*1</sup>	Torque command by remote register (RWw2) <sup>*2</sup>	Torque command by <b>Pr.805, Pr.806</b> <sup>*1</sup>	600 to 1400 (-400% to 400%)	1%
3	Torque command by remote register (RWw1 or RWwC) <sup>*2</sup>		Torque command by the buffer memory of PROFIBUS-DP (REF1 to 7) <sup>*2</sup>		
5	Torque command by remote register (RWw1 or RWwC) <sup>*2</sup>	Torque command by remote register (RWw2) <sup>*2</sup>	Torque command by the buffer memory of PROFIBUS-DP (REF1 to 7) <sup>*2</sup>	-32768 to 32767 (complement of 2) (-327.68% to 327.67%) <sup>*3</sup>	0.01% <sup>*3</sup>
6	Torque command by <b>Pr.805, Pr.806</b> <sup>*1</sup>		Torque command by <b>Pr.805, Pr.806</b> <sup>*1</sup>		

\*1 The torque command can also be given from operation panel or parameter unit.

\*2 The torque command can also be given by setting a value in **Pr.805** or **Pr.806**.

\*3 Setting range if set by operation panel or parameter unit is "673 to 1327 (-327% to 327%)"; setting increment is 1%.

#### NOTE

- For details on the FR-A8NC, FR-A8NCE, FR-A8NCG, or FR-A8NP setting, refer to the Instruction Manual for each communication option. For details on the CC-Link IE Field Network, refer to [page 752](#). For details on CC-Link IE TSN communication, refer to the CC-Link IE TSN Function Manual.
- For details on the setting using the PLC function, refer to the PLC Function Programming Manual.

### ◆ Torque command given by 16-bit digital input (Pr.804 = "4")

- Give the torque command by 12-bit or 16-bit digital input using FR-A8AX (plug-in option).

#### NOTE

- For details on FR-A8AX setting, refer to the Instruction Manual of FR-A8AX

### ◆ Changing the torque characteristic of the constant-power range (Pr.801, Pr.803)

- According to the motor's characteristics, base frequency or higher decreases the torque. To give the constant torque command in base frequency or higher, set "1 or 11" in **Pr.803 Constant output range torque characteristic selection**.
- Torque in a low-speed range is constant during torque control regardless of the setting of **Pr.803**. However, when "2" is set in **Pr.803** under Real sensorless vector control, the torque may not be kept constant in the low-speed range.

Pr.803 setting	Torque characteristic in constant-power range	
	Torque characteristic	Output limit
0 (initial value), 10	Constant motor output	—
1, 11	Constant torque	Without
2	Constant torque	With

- To avoid overload or overcurrent of the inverter or motor, use **Pr.801 Output limit level** to limit the torque current in the constant power range.

Pr.801 setting	Description
0 to 400%	Set the torque current limit level.
9999	The torque limit setting value ( <b>Pr.22, Pr.812 to Pr.817, etc.</b> ) is used for limiting the torque current.

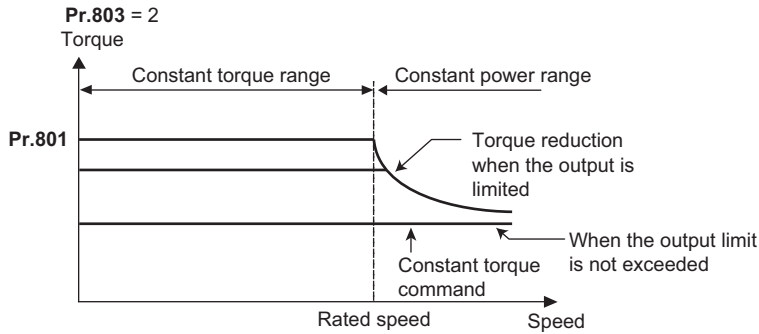
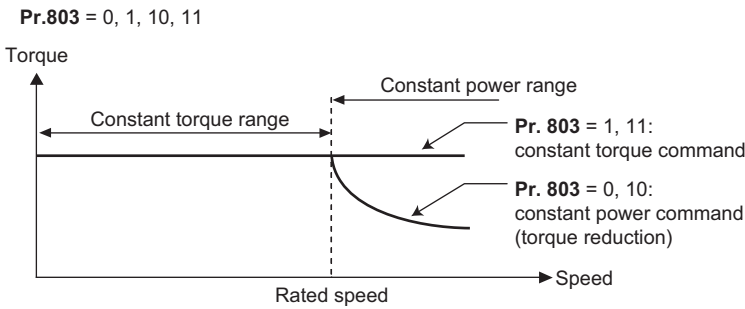

### ◆ Reverse selection of the torque command (Pr.1114)

- The Pr.1114 Torque command reverse selection setting determines whether or not the torque command polarity is reversed when the reverse rotation command (STR) is turned ON.

Pr.1114 setting	Torque command polarity at STR signal ON (sign)
0	Not reversed
1 (Initial value)	Reversed

« Parameters referred to »

Pr.868 Terminal 1 function assignment [page 500](#)  
 Calibration parameter C16 (Pr.919) to C19 (Pr.920) (terminal 1 bias, gain torque) [page 510](#)

## 5.4.5 Speed limit

**Sensorless** **Vector**

When operating under torque control, motor overspeeding may occur if the load torque drops to a value less than the torque command value, etc. Set the speed limit value to prevent overspeeding.

If the actual speed reaches or exceeds the speed limit value, the control method switches from torque control to speed control, preventing overspeeding.

Pr.	Name	Initial value		Setting range	Description
		FM	CA		
807 H410	Speed limit selection	0		0	Uses the speed command during speed control as the speed limit.
				1	Sets speed limits for forward and reverse directions individually by using Pr.808 and Pr.809.
				2	Forward/reverse rotation speed limit Applies speed limit by analog voltage input to the terminal 1. Speed limit for forward/reverse side is switched by its polarity.
808 H411	Forward rotation speed limit/speed limit	60 Hz	50 Hz	0 to 400 Hz	Sets the forward side speed limit.
809 H412	Reverse rotation speed limit/reverse-side speed limit	9999		0 to 400 Hz	Sets the reverse side speed limit.
				9999	Pr.808 setting value is effective.
1113 H414	Speed limit method selection	0		9999	Speed limit mode 1
				0	Speed limit mode 2
				1	Speed limit mode 3
				2	Speed limit mode 4
				10	X93 signal OFF: Speed limit mode 3, X93 signal ON: Speed limit mode 4

## ◆ Speed limit method selection (Pr.1113)

Pr.1113 setting	Speed limit method	Speed limit value
9999	Speed limit mode 1	Forward rotation speed limit Pr.807 = "0": Speed command during speed control Pr.807 = "1": Pr.808 Pr.807 = "2": Analog input at analog input of 0 to 10 V, or Pr.1 at analog input of -10 to 0 V Reverse rotation speed limit Pr.807 = "0": Speed command during speed control Pr.807 = "1": Pr.809, or Pr.808 when Pr.809 = "9999" Pr.807 = "2": Pr.1 at analog input of 0 to 10 V, or analog input at analog input of -10 to 0 V
0 (initial value)	Speed limit mode 2	Speed limit Pr.807 = "0 or 2": Speed command during speed control Pr.807 = "1": Pr.808
1	Speed limit mode 3	Reverse-side speed limit
2	Speed limit mode 4	Pr.809, or Pr.808 when Pr.809 = "9999"
10	Switching by external terminals	X93 signal OFF: Speed limit mode 3, X93 signal ON: Speed limit mode 4

## ◆ Control block diagram (speed limit mode 1)

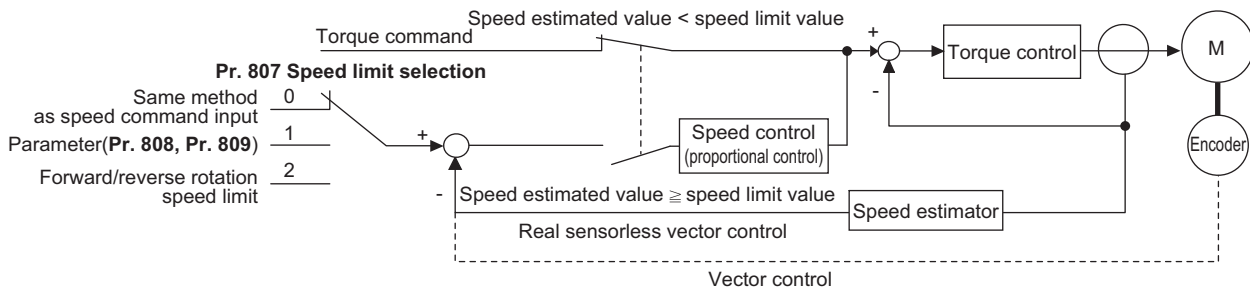

## ◆ Using the speed command during speed control (Pr.1113 = "9999", Pr.807 = "0").

- Speed limit is set by the same method as speed setting during speed control. (Speed setting by PU (operation panel/parameter unit), multi-speed setting, plug-in option, etc.)
- When the start signal turns ON, the limit level increases from 0 Hz to the set speed by taking the time set in **Pr.7 Acceleration time**. When the start signal turns OFF, the limit level at the time decreases to the operation start level of **Pr.10 DC injection brake operation frequency**, by taking the time set in **Pr.8 Deceleration time**.

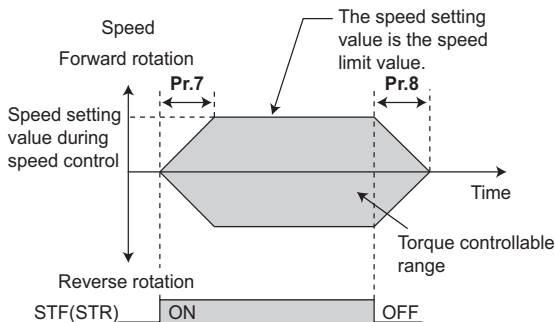

### NOTE

- The second and third acceleration/deceleration time can be set.
- When speed limit command exceeds **Pr.1 Maximum frequency** setting, the speed limit value becomes **Pr.1** setting. When speed limit command falls below **Pr.2 Minimum frequency** setting, the speed limit value becomes **Pr.2** setting. Also, the speed limit command is smaller than **Pr.13 Starting frequency**, the speed limit value becomes 0 Hz.
- To perform speed limit by analog input, calibrate analog input terminals 1, 2 and 4. (Refer to [page 505](#).)
- To use analog inputs to perform speed limit, turn the external signals (RH, RM, RL) OFF. If any of the external signals (RH, RM, RL) is ON, speed limit by multi-speed are enabled.

## ◆ Setting separately for forward and reverse rotation (Pr.1113 = "9999", Pr.807 = "1")

- Sets speed limits for forward and reverse directions individually by using **Pr.808 Forward rotation speed limit/speed limit** **Pr.809 Reverse rotation speed limit/reverse-side speed limit**.
- When **Pr.809** = "9999" (initial value), speed limit is determined by the setting value of **Pr.808** for both forward and reverse rotations.

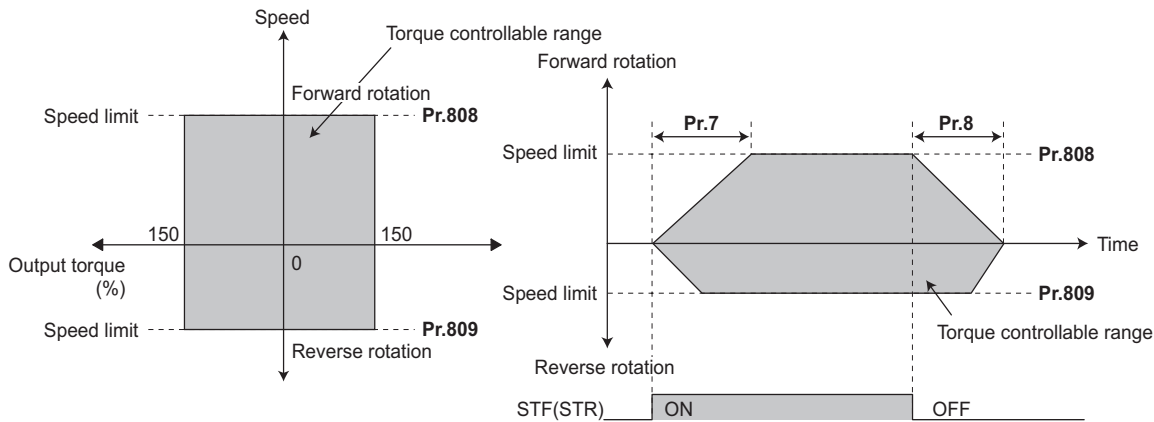

## ◆ Forward/reverse rotation speed limit using analog input (Pr.1113 = "9999", Pr.807 = "2")

- When performing speed limit by analog inputs to terminal 1, speed limit can be switched between forward and reverse rotation by its voltage polarity.
- When **Pr.868 Terminal 1 function assignment** = "5", forward/reverse speed limit is enabled.
- If 0 to 10 V is input, forward rotation speed limit is applied. Reverse rotation speed limit at this time is the value of **Pr.1 Maximum frequency**.
- If -10 to 0 V is input, reverse rotation speed limit is applied. Forward rotation speed limit at this time is the value of **Pr.1 Maximum frequency**.

- Upper speed limit is the value of **Pr.1** for both forward and reverse rotations.

- When terminal 1 input is "-10 to 0 V"

- When terminal 1 input is "0 to 10 V"

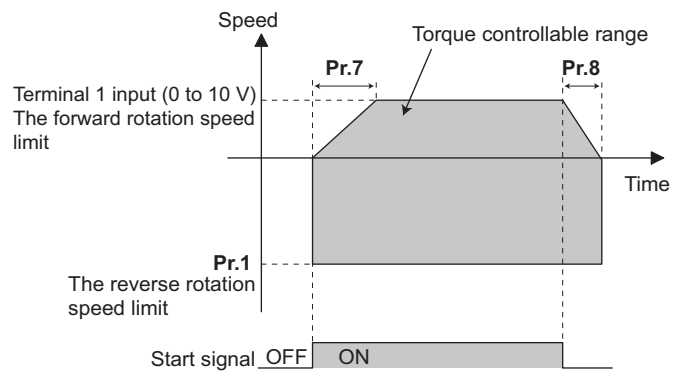
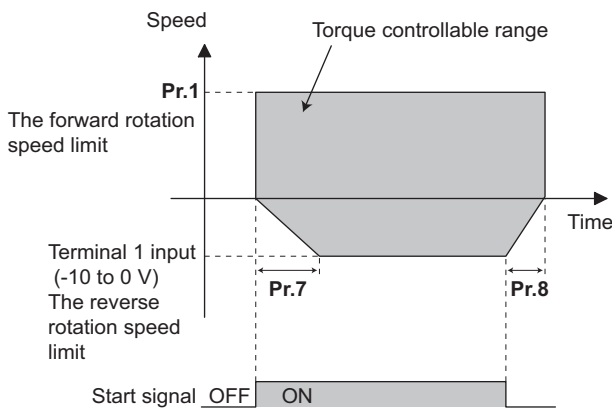
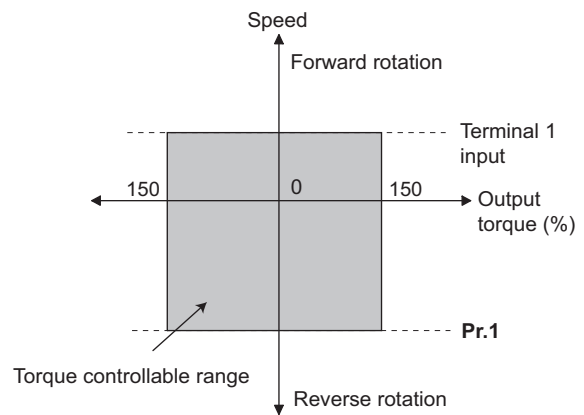
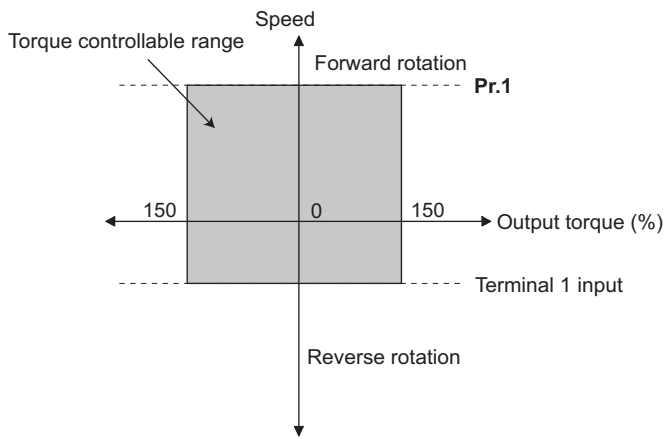

**NOTE**

- To perform speed limit by using terminal 1, calibrate terminal 1. (Refer to [page 505.](#))

**◆ Speed limit mode 2 (Pr.1113 = "0" initial value)**

- Following the polarity change in the torque command, the polarity of the speed limit value changes. This prevents the speed from increasing in the torque polarity direction. (When the torque command value is 0, the polarity of the speed limit value is positive.)
- When **Pr.807 Speed limit selection** = "0, 2", the setting during speed control is applied for the speed limit. When **Pr.807 Speed limit selection** = "1", **Pr.808 Forward rotation speed limit/speed limit** is applied for the speed limit.

- When the load has reversed the rotation opposite to the torque polarity, the setting of **Pr.809 Reverse rotation speed limit/reverse-side speed limit** is applied for the speed limit. (The speed limit value and reverse-side speed limit value are limited at **Pr.1 Maximum frequency** (maximum 400 Hz under Vector control).)

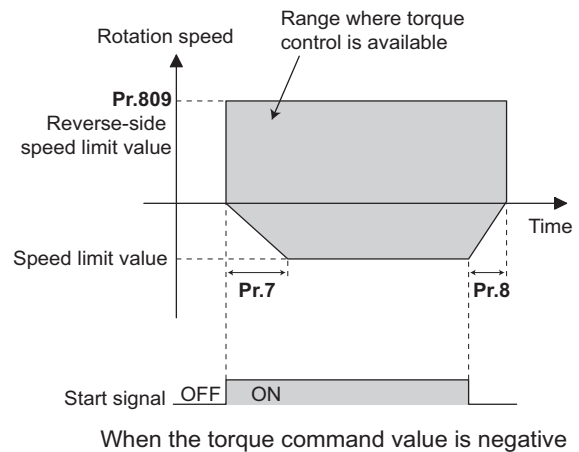
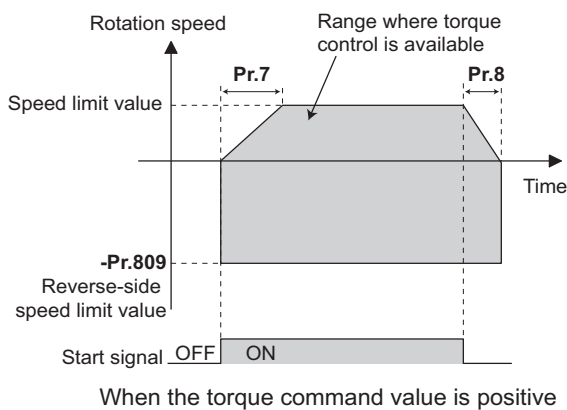
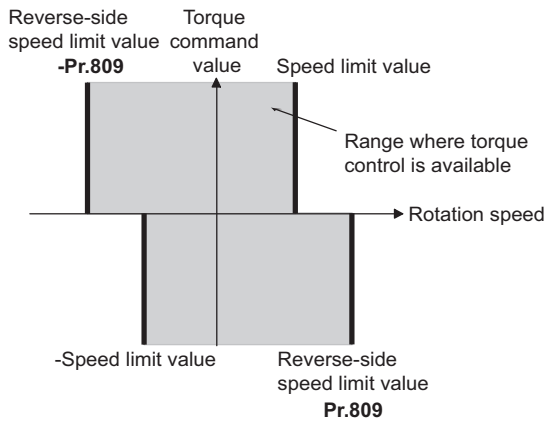

### ◆ Speed limit mode 3 (Pr.1113 = "1")

- Select this mode when the torque command is positive. The forward rotation command is for power driving (such as winding) and the reverse rotation command is for regenerative driving (such as unwinding). (Refer to each following figures.)
- When **Pr.807 Speed limit selection** = "0, 2", the setting during speed control is applied for the speed limit. When **Pr.807 Speed limit selection** = "1", **Pr.808 Forward rotation speed limit/speed limit** is applied for the speed limit.



- When the torque command becomes negative, the setting of **Pr.809 Reverse rotation speed limit/reverse-side speed limit** is applied to prevent the speed from increasing in the reverse rotation direction. (The speed limit value and reverse-side speed limit value are limited at **Pr.1 Maximum frequency** (maximum 400 Hz under Vector control).)

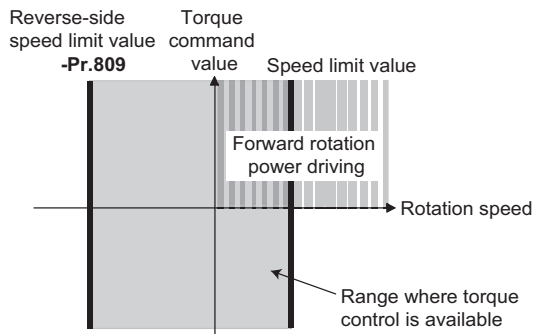
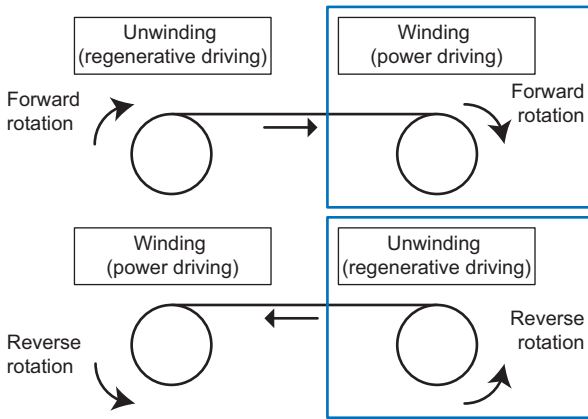

For forward rotation command

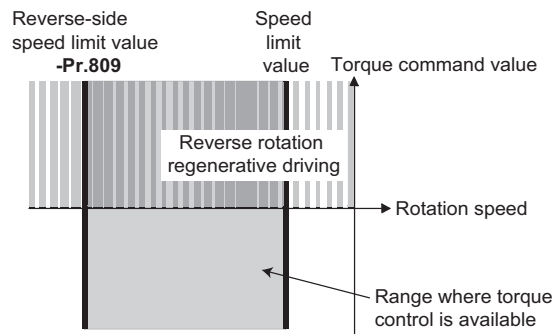

For reverse rotation command

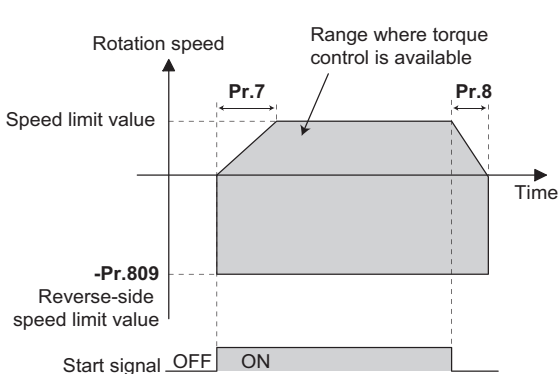

For power driving by forward rotation command (winding)

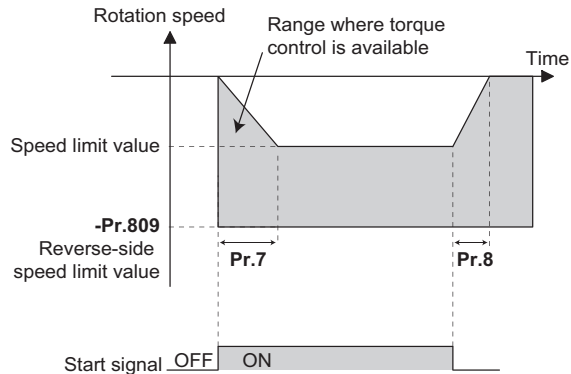

For regenerative driving by reverse rotation command (unwinding)

### ◆ Speed limit mode 4 (Pr.1113 = "2")

- Select this mode when the torque command is negative. The forward rotation command is for regenerative driving (such as unwinding) and the reverse rotation command is for power driving (such as winding). (Refer to each following figures.)
- When **Pr.807 Speed limit selection** = "0, 2", the setting during speed control is applied for the speed limit. When **Pr.807 Speed limit selection** = "1", **Pr.808 Forward rotation speed limit/speed limit** is applied for the speed limit.

- When the torque command becomes negative, the setting of **Pr.809 Reverse rotation speed limit/reverse-side speed limit** is applied to prevent the speed from increasing in the reverse rotation direction. (The speed limit value and reverse-side speed limit value are limited at **Pr.1 Maximum frequency** (maximum 400 Hz under Vector control).)

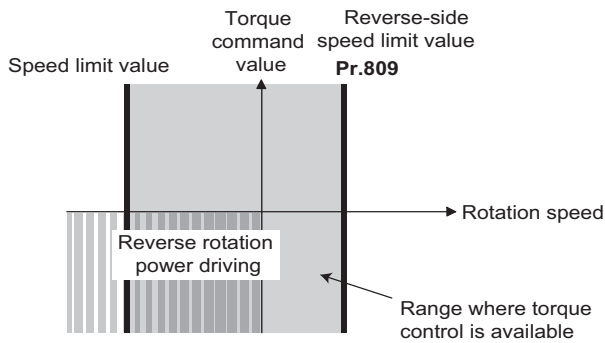
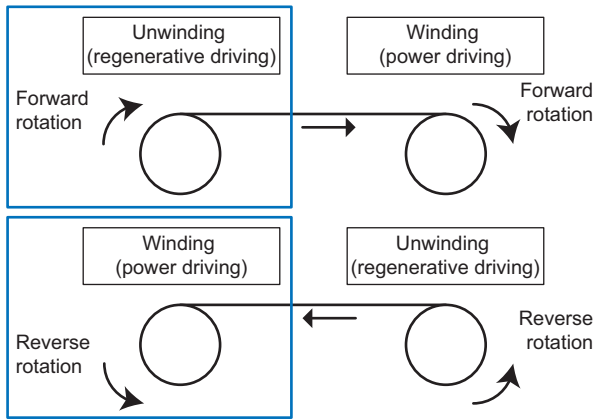

For reverse rotation command

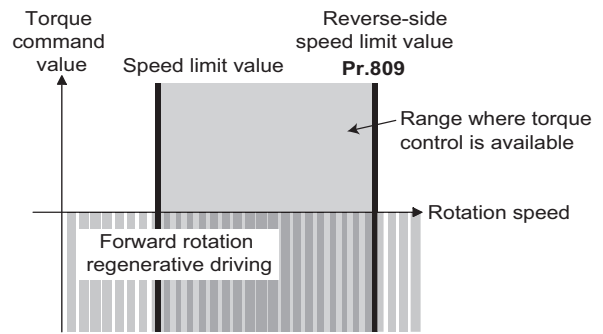

For forward rotation command

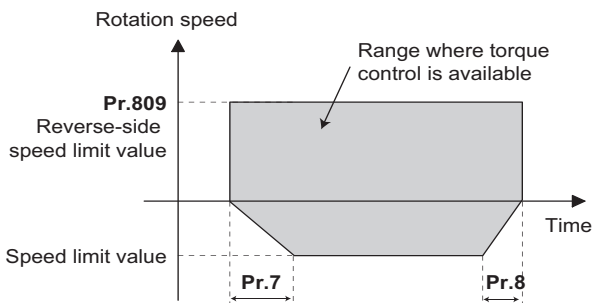

For power driving by reverse rotation command (winding)

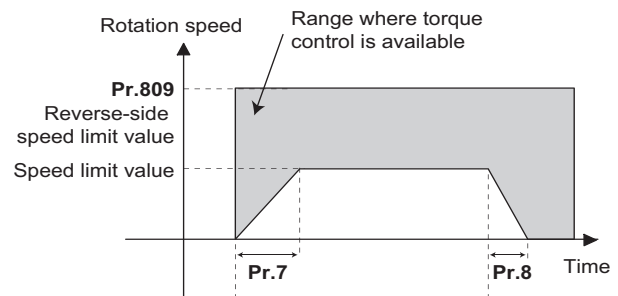

For regenerative driving by forward rotation command (unwinding)

### ◆ Speed limit mode switching via external terminals (Pr.1113 = "10")

- The speed limit mode can be switched between 3 and 4 using the Torque control selection (X93) signal.
- To assign the X93 signal, set "93" in any of **Pr.178 to Pr.189 (Input terminal function selection)**.

X93 signal	Speed limit mode
OFF	Mode 3 (positive torque command, same status as setting <b>Pr.1113 = "1"</b> )
ON	Mode 4 (negative torque command, same status as setting <b>Pr.1113 = "2"</b> )

**NOTE**

- During the speed limit operation, "SL" (SL) is displayed on the operation panel and the OL signal is output.
- OL signal is assigned to terminal OL in the initial status. Set "3" in one of **Pr.190 to Pr.196 (Output terminal function selection)** to assign the RT signal to another terminal. Changing the terminal assignment using **Pr.190 to Pr.196** may affect the other functions. Set parameters after confirming the function of each terminal.
- Changing the terminal assignment using **Pr.178 to Pr.189 (Input terminal function selection)** may affect the other functions. Set parameters after confirming the function of each terminal.

«Parameters referred to»

Pr.1 Maximum frequency, Pr.2 Minimum frequency [page 428](#)  
 Pr.4 to Pr.6, Pr.24 to 27, Pr.232 to Pr.239 (multi-speed operation) [page 411](#)  
 Pr.7 Acceleration time, Pr.8 Deceleration time [page 367](#)  
 Pr.13 Starting frequency [page 381](#)  
 Pr.190 to Pr.196 (output terminal function selection) [page 473](#)  
 Pr.868 Terminal 1 function assignment [page 500](#)  
 Pr.125, Pr.126, C2 to C7, C12 to C15 (Frequency setting voltage (current) bias/gain) [page 505](#)

## 5.4.6 Torque control gain adjustment

Sensorless Vector

Operation is normally stable enough in the initial setting, but some adjustments can be made if abnormal vibration, noise or overcurrent occur for the motor or machinery.

Pr.	Name	Initial value	Setting range	Description
824 G213	Torque control P gain 1 (current loop proportional gain)	100%	0 to 500%	Set the current loop proportional gain.
825 G214	Torque control integral time 1 (current loop integral time)	5 ms	0 to 500 ms	Set current loop integral compensation time.
834 G313	Torque control P gain 2 (current loop proportional gain)	9999	0 to 500%	Sets the current loop proportional gain when RT signal is ON.
			9999	The Pr.824 setting is applied to the operation.
835 G314	Torque control integral time 2 (current loop integral time)	9999	0 to 500 ms	Sets the current loop integral compensation time when RT signal is ON.
			9999	The Pr.825 setting is applied to the operation.

### ◆ Current loop proportional (P) gain adjustment (Pr.824)

- The 100% current loop proportional gain is equivalent to 1000 rad/s during Real sensorless vector control, and to 1400 rad/s during Vector control.
- For ordinary adjustment, try to set within the range of 50 to 500%.
- Set the proportional gain for during torque control.
- If setting value is large, changes in current command can be followed well and current fluctuation relative to external disturbance is smaller. If the setting value is however too large, it becomes unstable and high frequency torque pulse is produced.

### ◆ Current control integral time adjustment (Pr.825)

- Set the integral time of current control during torque control.
- Torque response increases if set small; current however becomes unstable if set too small.
- If the setting value is small, it produces current fluctuation toward disturbance, decreasing time until it returns to original current value.

### ◆ Using two types of gain (Pr.834, Pr.835)

- Use **Pr.834 Torque control P gain 2 (current loop proportional gain)**, **Pr.835 Torque control integral time 2 (current loop integral time)** if the gain setting needs to be switched according to application or if multiple motors are switched by a single inverter.
- **Pr.834, Pr.835** is enabled when the second function selection (RT) signal is turned ON.

**NOTE**

- The RT signal is a second function selection signal which also enables other second functions. (Refer to [page 525](#).)
- The RT signal is assigned to terminal RT in the initial status. Set "3" in one of **Pr.178 to Pr.189 (Input terminal function selection)** to assign the RT signal to another terminal.

### ◆ Adjustment procedure

Adjust if any of phenomena such as unusual vibration, noise, current or overcurrent is produced by the motor or machinery.

1. Change the **Pr.824** setting while checking the conditions.
2. If it cannot be adjusted well, change the **Pr.825** setting, and perform step 1 again.

Adjustment method	
Set <b>Pr.824</b> lower and <b>Pr.825</b> longer. First, lower <b>Pr.824</b> and then check of there is still any abnormal vibration, noise or current from the motor. If it still requires improvement, make <b>Pr.825</b> longer.	
<b>Pr.824</b>	Lower the setting by 10% each time and set a value that is approximately 80 to 90% of the setting immediately before the abnormal noise or current improves. If set too low, current ripple is produced and produces a sound from the motor that synchronizes with it.
<b>Pr.825</b>	Lengthen the current setting by doubling it each time and set a value that is approximately 80 to 90% of the setting value, immediately before abnormal noise or current is improved. If set too long, current ripple is produced and produces a sound from the motor that synchronizes with it.

## 5.4.7 Troubleshooting in torque control

Sensorless Vector

	Condition	Possible cause	Countermeasure
1	Torque control does not operate properly.	• There is incorrect phase sequence between the motor wiring and encoder wiring.	• Check the wiring. (Refer to <a href="#">page 91</a> .)
		• <b>Pr.800 Control method selection</b> is not appropriate.	• Check the <b>Pr.800</b> setting. (Refer to <a href="#">page 221</a> .)
		• The speed limit value has not been input.	• Set the speed limit value. (If speed limit value is not input, it becomes 0 Hz by default and the motor does not run.)
		• Torque command varies.	• Check that the torque command sent from the controller is correct. • Set <b>Pr.72 PWM frequency selection</b> lower. • Set <b>Pr.826 Torque setting filter 1</b> higher.
		• The torque command and the torque recognized by the inverter are different.	• Re-calibrate the settings of <b>C16 Terminal 1 bias command (torque/magnetic flux)</b> , <b>C17 Terminal 1 bias (torque/magnetic flux)</b> , <b>C18 Terminal 1 gain command (torque/magnetic flux)</b> , <b>C19 Terminal 1 gain (torque/magnetic flux)</b> (Refer to <a href="#">page 510</a> .)
		• Torque fluctuation due to motor temperature variation	• Select the magnetic flux observer by <b>Pr.95 Online auto tuning selection</b> . (Refer to <a href="#">page 558</a> .)
		• The option to be used and parameter settings do not match.	• Correctly set <b>Pr.862 Encoder option selection</b> according to the option to be used. (Refer to <a href="#">page 226</a> .)
2	When a small torque command is given, the motor rotates in a direction opposite to the start signal.	• Torque offset calibration is inaccurate.	• Re-calibrate <b>C16 and C17</b> . (Refer to <a href="#">page 510</a> .)
3	Torque control cannot operate normally during acceleration/deceleration. The motor vibrates.	• Speed limit is operating. (Speed limit may operate because the speed limit value will increase or decrease according to acceleration/deceleration time setting of <b>Pr.7 and Pr.8</b> when <b>Pr.807</b> = "0 or 2".)	• Set the acceleration/deceleration time shorter. Alternatively, set "0" for the acceleration/deceleration time. (Forward/reverse rotation speed limit at this time is the value at a constant speed.)
4	Output torque is nonlinear for the torque command.	Torque shortage.	Return <b>Pr.854 Excitation ratio</b> to the initial value.

Parameters referred to

- Pr.72 PWM frequency selection [page 356](#)
- Pr.178 to Pr.189 (Input terminal function selection) [page 521](#)
- Pr.800 Control method selection [page 221](#)

## 5.4.8 Torque control by variable-current limiter control

### Vector

By changing the torque limit value for speed control, torque control can be performed.

Pr.	Name	Initial value	Setting range	Description
800 G200	Control method selection	20	6	Vector control
			106	Torque control under Vector control (fast-response operation)
			0 to 5, 100 to 105	Vector control
			9, 109	Vector control test operation
			10 to 12, 110 to 112	Real sensorless vector control
			13 to 14, 113, 114	(PM sensorless vector control)
			20	V/F control (Advanced magnetic flux vector control, PM sensorless vector control)
451 G300	Second motor control method selection	9999	0 to 6, 10 to 14, 20, 100 to 106, 110 to 114	Select the control method for the second motor. The second motor is enabled when the RT signal is ON. The setting range is the same as that of <b>Pr.800</b> .
			9999	The setting value of <b>Pr.800</b> is used.

- By adding the bias amount to the line speed (master speed) as the speed command value to saturate the speed controller and changing the torque limit value, torque control can be performed.
- For a positive bias amount (the speed command value faster than the line speed), power driving is applied, and for a negative bias amount (the speed command value slower than the line speed), regenerative driving is applied.
- Speed control is the basic control. For how to set the speed command and torque limit value, refer to the description of speed control ([page 235](#)).

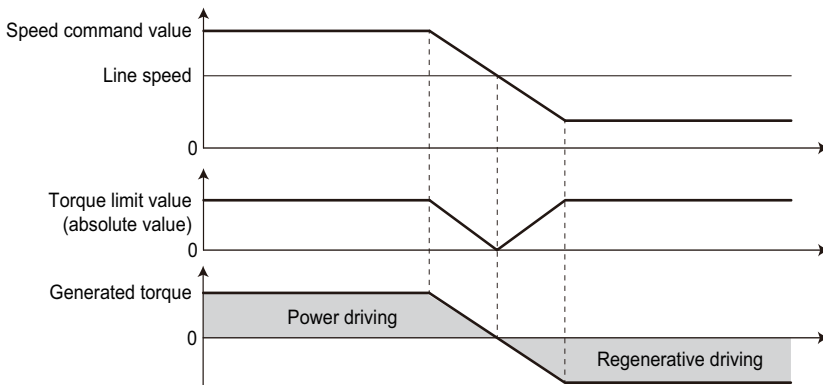

- Under speed control with **Pr.800** = "0 or 100", when the speed command value is changed by an external force, the torque limit is invalid during a change in the speed command value to adjust the internal speed command value to the actual speed.

Under variable speed limiter control with **Pr.800** = "6 or 106", the process to adjust the speed command value to the actual speed is not performed, and thus the torque limit remains valid. This prevents torque from suddenly changing at a speed change.

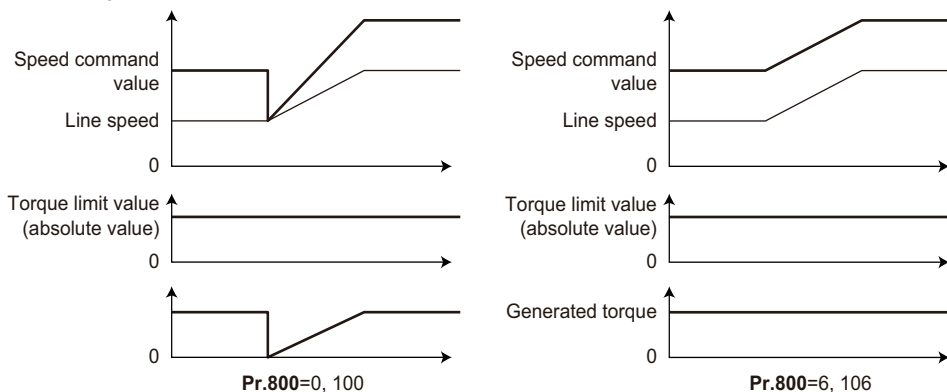



 **NOTE**

- When **Pr.800** = "6 or 106" (torque control by a variable-current limiter), **Pr.690 Deceleration check time** and **Pr.873 Speed limit** are ignored.

« **Parameters referred to** »

**Pr.690 Deceleration check time**  [page 269](#)

**Pr.873 Speed limit**  [page 269](#)

**Pr.800 Control method selection, Pr.451 Second motor control method selection**  [page 221](#)

# 5.5 Position control under vector control and PM sensorless vector control

Purpose	Parameter to set		Refer to page	
To perform Simple position control by setting parameters	Parameter position command	P.B000, P.B020 to P.B050, P.B101, P.B120 to P.B188, P.B190 to P.B195	Pr.419, Pr.464 to Pr.494, Pr.1221 to Pr.1290, Pr.1292, Pr.1293	303
To perform position control by pulse input to the inverter	Simple pulse train position command	P.B000, P.B009, P.B010	Pr.419, Pr.428, Pr.429	319
To adjust the gear ratio of the motor and machine	Electronic gear settings	P.B001, P.B002, P.B005	Pr.420, Pr.421, Pr.424	325
To improve the precision of the position control	Position adjustment parameter settings	P.B007 to P.B008, P.B192 to P.B195	Pr.426 to Pr.427, Pr.1294 to Pr.1297	327
	Position control gain adjustment	P.B003, P.B004, P.B006, P.B012, P.B013, P.G220, P.G224, P.C114	Pr.422, Pr.423, Pr.425, Pr.446, Pr.828, Pr.877, Pr.880, Pr.1298	328
To monitor pulses	Pulse monitor selection	P.B011	Pr.430	321
	Cumulative pulse monitoring	P.M610 to P.M613	Pr.635 to Pr.638	321

## 5.5.1 About position control

**Vector** **PM**

- In position control, speed commands, which are calculated to eliminate the difference between the command pulse (parameter setting) and the feedback pulse number, are output to rotate the motor.
- This inverter can perform simple positioning by contact input or position control by simple pulse input to the inverter.

### ◆ Control block diagram

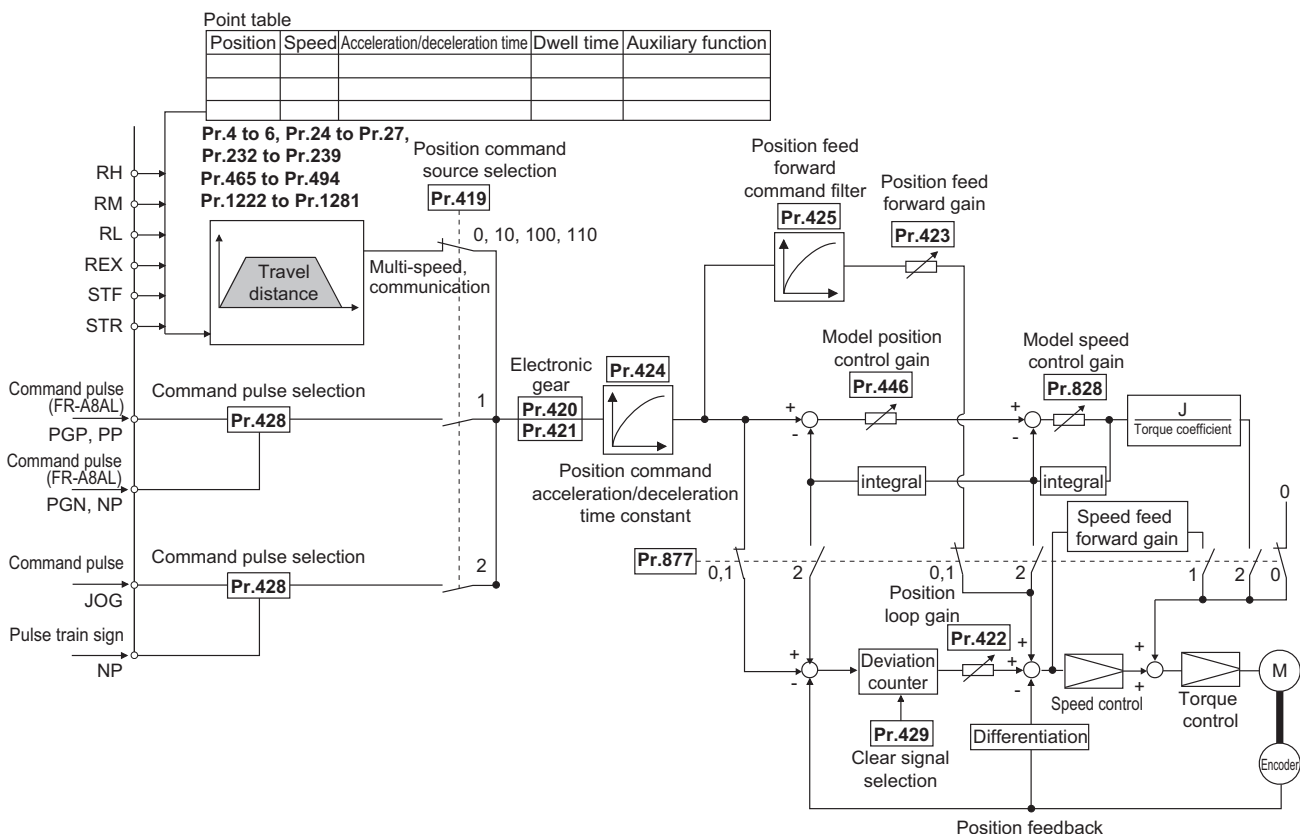

## ◆ Operation example

- Calculate the speed command so that the difference between the number of pulses of the internal pulse train (if **Pr.419** = "0", command pulses are used in the inverter from the number of pulses defined by parameters (**Pr.465 to Pr.494**)) and the number of pulses in the feedback from the motor terminal encoder (estimated value when PM sensorless vector control is used) is 0, and then rotate the motor based on the calculation.
  - 1) Once a pulse train is input, pulses are accumulated in the deviation counter, and the droop pulses in this counter become position control pulses and speed command.
  - 2) When the motor starts to rotate in response to the speed command from the inverter, feedback pulses are also generated by the encoder at the same time. Subtract the encoder feedback pulses or feedback estimate value from the droop pulses in the deviation counter. The deviation counter keeps rotating the motor while keeping a certain droop amount.
  - 3) If the command pulse input stops, the amount of droop pulses in the deviation counter decreases and thus the speed slows down. When there is no droop pulse, the motor stops.
  - 4) If the number of droop pulses becomes smaller than the value set in **Pr.426 In-position width**, the system determines that positioning is complete and the In-position (Y36) signal is turned ON.

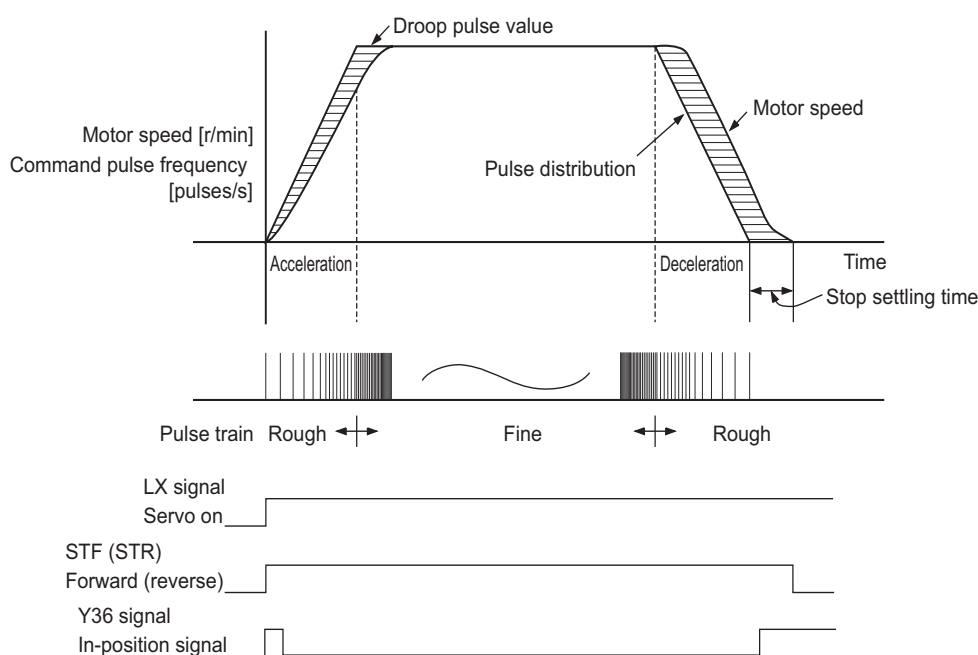

- The pulses are slow during motor acceleration and fast at full speed. The pulses become slower during deceleration, and eventually reach 0 and the motor stops a little after the command pulse. This time difference is necessary to ensure stop accuracy and is called stop setting time.

### NOTE

- To assign the Pre-excitation/servo ON (LX) signal, set "23" in any of **Pr.178 to Pr.189 (Input terminal function selection)**.
- To assign the In-position (Y36) signal, set "36" in any of **Pr.190 to Pr.196 (Output terminal function selection)**.
- Changing the terminal functions with **Pr.178 to Pr.189 and Pr.190 to Pr.196** may affect other functions. Set parameters after confirming the function of each terminal.

### Parameters referred to

**Pr.178 to Pr.189 (Input terminal function selection)** [page 521](#)  
**Pr.190 to Pr.196 (Output terminal function selection)** [page 473](#)



## 5.5.2 Setting procedure of Vector control (position control)

### Vector

#### ◆ Using an induction motor

##### Operating procedure

1. Perform secure wiring. (Refer to [page 87](#).)  
Install a Vector control compatible option.
2. Set the option to be used (**Pr.862**).  
Set **Pr.862 Encoder option selection** according to the option to be used. (Refer to [page 221](#).)
3. Set the motor and the encoder (**Pr.71**, **Pr.359 (Pr.852)**, **Pr.369 (Pr.851)**). (Refer to [page 94](#).)
4. Set the overheat protection of the motor (**Pr.9**). (Refer to [page 415](#).)  
When using the SF-V5RU or a motor equipped with a thermal sensor, set **Pr.9** = 0 A.
5. Set the motor capacity and number of motor poles (**Pr.80**, **Pr.81**). (Refer to [page 221](#).)  
V/F control is performed when the setting is "9999" (initial value).
6. Set the rated motor voltage and frequency (**Pr.83**, **Pr.84**). (Refer to [page 95](#).)
7. Select the control method (**Pr.800**). (Refer to [page 221](#).)  
Set **Pr.800** = "3" (position control), "4" (speed - position switching), or "5" (position - torque switching) to enable position control.
8. Select the position command source (**Pr.419**).
  - For position command given by point table, set **Pr.419** = "0 (initial value), 10, 100, or 110" to set the positioning parameters (**Pr.465 to Pr.494**, **Pr.1222 to Pr.1281**). (Refer to [page 303](#).)
  - For position command given by inverter pulse train input, set **Pr.419** = "2" to select a pulse train type for commands (**Pr.428**). (Refer to [page 320](#).)
  - For position command given from the positioning module of the programmable controller, set **Pr.419** = "1" to select a pulse train type for commands (**Pr.428**). (Refer to [page 316](#).)
9. Perform the test operation.

##### As required

- Set the electronic gear. (Refer to [page 325](#).)
- Set the position adjustment parameters. (Refer to [page 327](#).)
- Adjust the position control gain. (Refer to [page 328](#).)
- Set the torque limit. (Refer to [page 245](#).)

##### NOTE

- The carrier frequency is limited during Vector control. (Refer to [page 356](#).)
- Refer to the Instruction Manual of each option for details on Vector control using the FR-A8APR, FR-A8APS, or FR-A8APA.
- To perform operation in position control mode, the Pre-excitation/servo ON (LX) signal needs to be turned ON. To assign the LX signal, set "23" in any of **Pr.178 to Pr.189 (Input terminal function selection)**.

## ◆ Using a PM motor

### Operating procedure

1. Set the applied encoder (**Pr.359 (Pr.852), Pr.369 (Pr.851)**).  
Refer to [page 94](#) and set the parameters according to the option and the encoder to be used.
2. Set the applied motor (**Pr.9, Pr.71, Pr.80, Pr.81, Pr.83, Pr.84**).  
Set **Pr.71 Applied motor, Pr.9 Rated motor current, Pr.80 Motor capacity, Pr.81 Number of motor poles, Pr.83 Rated motor voltage**, and **Pr.84 Rated motor frequency** according to the motor specifications. (Setting "9999 (initial value)" in **Pr.80 or Pr.81** selects V/F control.) Set **Pr.702, Pr.706, Pr.707, Pr.724** and **Pr.725** as required.
3. Select Vector control (speed control). (Refer to [page 221](#).)
4. Perform offline auto tuning and encoder position tuning (**Pr.96**). (Refer to [page 542](#).)  
Set **Pr.96**, and perform tuning.
5. Configure the initial parameter setting for the applied motor using **Pr.998**.  
When the setting for the PM motor is selected in **Pr.998 PM parameter initialization**, Vector control for the PM motor with an encoder is enabled.  
"8009": Parameter (rotations per minute) settings for an IPM motor other than MM-CF  
"8109": Parameter (frequency) settings for an IPM motor other than MM-CF  
"9009": Parameter (rotations per minute) settings for an SPM motor  
"9109": Parameter (frequency) settings for an SPM motor
6. Set **Pr.800** to position control.
7. Perform the test operation.

#### NOTE

- For PM motors, after performing offline auto tuning and encoder position tuning, first perform PM parameter initialization. If parameter initialization is performed after setting other parameters, some of those parameters are initialized too. (Refer to [page 231](#) for the parameters that are initialized.)

## 5.5.3 Setting procedure of PM sensorless vector control (position control)

### PM

#### Operating procedure

1. Perform IPM parameter initialization. (Refer to [page 230](#).)  
Set "3003 or 3103" in **Pr.998 PM parameter initialization** or select "3003" in "PM" (IPM parameter initial settings).

Setting	Description
3003	Parameter settings for MM-CF IPM motor (rotations per minute)
3103	Parameter settings for MM-CF IPM motor (frequencies)

2. Select the control mode (**Pr.800**). (Refer to [page 221](#).)  
Set **Pr.800** = "13" (position control) or "14" (speed/position switchover) to enable position control.
3. Select the position command source (**Pr.419**).
  - For position command given by point table, set **Pr.419** = "0 (initial value), 10, 100, or 110" to set the positioning parameters (**Pr.465 to Pr.494, Pr.1222 to Pr.1281**). (Refer to [page 303](#).)
  - For position command given by inverter pulse train input, set **Pr.419** = "2" to select a pulse train type for commands (**Pr.428**). (Refer to [page 319](#).)
  - For position command given from the positioning module of the programmable controller, set **Pr.419** = "1" to select a pulse train type for commands (**Pr.428**). (Refer to [page 316](#).)
4. Perform the test operation.

As required

- Set the electronic gear. (Refer to [page 325](#).)
- Set the position adjustment parameters. (Refer to [page 327](#).)
- Adjust the position control gain. (Refer to [page 328](#).)
- Set the torque limit. (Refer to [page 245](#).)

#### NOTE

- The carrier frequency is limited during PM sensorless vector control. (Refer to [page 356](#).)
- Position deviation may occur due to motor temperature changes. In such case, shut off the inverter outputs, and restart.
- Perform position control under PM sensorless vector control only when using an MM-CF IPM motor with low-speed range high-torque characteristic (**Pr.788** = "9999 (initial value)")
- Position control is performed on the assumption of 4096 pulses/motor rotation.  
The positioning accuracy is 200 pulses/rev for 1.5K or lower, and 100 pulses/rev for 2K or higher (under no load).
- To perform operation in position control mode, the Pre-excitation/servo ON (LX) signal needs to be turned ON. To assign the LX signal, set "23" in any of **Pr.178 to Pr.189 (Input terminal function selection)**.

## 5.5.4 Simple positioning function by parameters



Set positioning parameters such as the number of pulses (position) and acceleration/deceleration time in advance to create a point table (point table method). Positioning operation is performed by selecting the point table.

Pr.	Name	Initial value	Setting range	Description
419 B000	Position command source selection	0	0, 10, 100, 110, 200, 210, 300, 310, 1110, 1310	Simple position control by point table (Settings are available for the home position data at servo-OFF, clearing of the current position 2 monitor value, and the absolute position control.)
			1	Position command given by the pulse train input to the FR-A8AL*1
			2	Simple pulse train position command given by the pulse train input to the inverter
464 B020	Digital position control sudden stop deceleration time	0 s	0 to 360 s	Set the time period until the inverter stops when the forward rotation (reverse rotation) command is turned OFF with the position feed forward function.
465 B021	First target position lower 4 digits	0	0 to 9999	Set the target position of the point table 1.
466 B022	First target position upper 4 digits	0	0 to 9999	
467 B023	Second target position lower 4 digits	0	0 to 9999	Set the target position of the point table 2.
468 B024	Second target position upper 4 digits	0	0 to 9999	
469 B025	Third target position lower 4 digits	0	0 to 9999	Set the target position of the point table 3.
470 B026	Third target position upper 4 digits	0	0 to 9999	
471 B027	Fourth target position lower 4 digits	0	0 to 9999	Set the target position of the point table 4.
472 B028	Fourth target position upper 4 digits	0	0 to 9999	
473 B029	Fifth target position lower 4 digits	0	0 to 9999	Set the target position of the point table 5.
474 B030	Fifth target position upper 4 digits	0	0 to 9999	
475 B031	Sixth target position lower 4 digits	0	0 to 9999	Set the target position of the point table 6.
476 B032	Sixth target position upper 4 digits	0	0 to 9999	
477 B033	Seventh target position lower 4 digits	0	0 to 9999	Set the target position of the point table 7.
478 B034	Seventh target position upper 4 digits	0	0 to 9999	
479 B035	Eighth target position lower 4 digits	0	0 to 9999	Set the target position of the point table 8.
480 B036	Eighth target position upper 4 digits	0	0 to 9999	
481 B037	Ninth target position lower 4 digits	0	0 to 9999	Set the target position of the point table 9.
482 B038	Ninth target position upper 4 digits	0	0 to 9999	
483 B039	Tenth target position lower 4 digits	0	0 to 9999	Set the target position of the point table 10.
484 B040	Tenth target position upper 4 digits	0	0 to 9999	
485 B041	Eleventh target position lower 4 digits	0	0 to 9999	Set the target position of the point table 11.
486 B042	Eleventh target position upper 4 digits	0	0 to 9999	

Pr.	Name	Initial value	Setting range	Description
487 B043	Twelfth target position lower 4 digits	0	0 to 9999	Set the target position of the point table 12.
488 B044	Twelfth target position upper 4 digits	0	0 to 9999	
489 B045	Thirteenth target position lower 4 digits	0	0 to 9999	Set the target position of the point table 13.
490 B046	Thirteenth target position upper 4 digits	0	0 to 9999	
491 B047	Fourteenth target position lower 4 digits	0	0 to 9999	Set the target position of the point table 14.
492 B048	Fourteenth target position upper 4 digits	0	0 to 9999	
493 B049	Fifteenth target position lower 4 digits	0	0 to 9999	Set the target position of the point table 15.
494 B050	Fifteenth target position upper 4 digits	0	0 to 9999	
1221 B101	Start command edge detection selection	0	0	Turning OFF the forward (reverse) rotation command stops the motor in the setting time of <b>Pr.464</b> .
			1	Position forward is continued even if the forward (reverse) rotation command is turned OFF.
1222 B120	First positioning acceleration time	5 s	0.01 to 360 s	Set the characteristics of the point table 1.
1223 B121	First positioning deceleration time	5 s	0.01 to 360 s	
1224 B122	First positioning dwell time	0 ms	0 to 20000 ms	
1225 B123	First positioning sub-function	10	0 to 2, 10 to 12, 100 to 102, 110 to 112	
1226 B124	Second positioning acceleration time	5 s	0.01 to 360 s	Set the characteristics of the point table 2.
1227 B125	Second positioning deceleration time	5 s	0.01 to 360 s	
1228 B126	Second positioning dwell time	0 ms	0 to 20000 ms	
1229 B127	Second positioning sub-function	10	0 to 2, 10 to 12, 100 to 102, 110 to 112	
1230 B128	Third positioning acceleration time	5 s	0.01 to 360 s	Set the characteristics of the point table 3.
1231 B129	Third positioning deceleration time	5 s	0.01 to 360 s	
1232 B130	Third positioning dwell time	0 ms	0 to 20000 ms	
1233 B131	Third positioning sub-function	10	0 to 2, 10 to 12, 100 to 102, 110 to 112	
1234 B132	Fourth positioning acceleration time	5 s	0.01 to 360 s	Set the characteristics of the point table 4.
1235 B133	Fourth positioning deceleration time	5 s	0.01 to 360 s	
1236 B134	Fourth positioning dwell time	0 ms	0 to 20000 ms	
1237 B135	Fourth positioning sub-function	10	0 to 2, 10 to 12, 100 to 102, 110 to 112	
1238 B136	Fifth positioning acceleration time	5 s	0.01 to 360 s	Set the characteristics of the point table 5.
1239 B137	Fifth positioning deceleration time	5 s	0.01 to 360 s	
1240 B138	Fifth positioning dwell time	0 ms	0 to 20000 ms	
1241 B139	Fifth positioning sub-function	10	0 to 2, 10 to 12, 100 to 102, 110 to 112	

Pr.	Name	Initial value	Setting range	Description
1242 B140	Sixth positioning acceleration time	5 s	0.01 to 360 s	Set the characteristics of the point table 6.
1243 B141	Sixth positioning deceleration time	5 s	0.01 to 360 s	
1244 B142	Sixth positioning dwell time	0 ms	0 to 20000 ms	
1245 B143	Sixth positioning sub-function	10	0 to 2, 10 to 12, 100 to 102, 110 to 112	
1246 B144	Seventh positioning acceleration time	5 s	0.01 to 360 s	Set the characteristics of the point table 7.
1247 B145	Seventh positioning deceleration time	5 s	0.01 to 360 s	
1248 B146	Seventh positioning dwell time	0 ms	0 to 20000 ms	
1249 B147	Seventh positioning sub-function	10	0 to 2, 10 to 12, 100 to 102, 110 to 112	
1250 B148	Eighth positioning acceleration time	5 s	0.01 to 360 s	Set the characteristics of the point table 8.
1251 B149	Eighth positioning deceleration time	5 s	0.01 to 360 s	
1252 B150	Eighth positioning dwell time	0 ms	0 to 20000 ms	
1253 B151	Eighth positioning sub-function	10	0 to 2, 10 to 12, 100 to 102, 110 to 112	
1254 B152	Ninth positioning acceleration time	5 s	0.01 to 360 s	Set the characteristics of the point table 9.
1255 B153	Ninth positioning deceleration time	5 s	0.01 to 360 s	
1256 B154	Ninth positioning dwell time	0 ms	0 to 20000 ms	
1257 B155	Ninth positioning sub-function	10	0 to 2, 10 to 12, 100 to 102, 110 to 112	
1258 B156	Tenth positioning acceleration time	5 s	0.01 to 360 s	Set the characteristics of the point table 10.
1259 B157	Tenth positioning deceleration time	5 s	0.01 to 360 s	
1260 B158	Tenth positioning dwell time	0 ms	0 to 20000 ms	
1261 B159	Tenth positioning sub-function	10	0 to 2, 10 to 12, 100 to 102, 110 to 112	
1262 B160	Eleventh positioning acceleration time	5 s	0.01 to 360 s	Set the characteristics of the point table 11.
1263 B161	Eleventh positioning deceleration time	5 s	0.01 to 360 s	
1264 B162	Eleventh positioning dwell time	0 ms	0 to 20000 ms	
1265 B163	Eleventh positioning sub-function	10	0 to 2, 10 to 12, 100 to 102, 110 to 112	
1266 B164	Twelfth positioning acceleration time	5 s	0.01 to 360 s	Set the characteristics of the point table 12.
1267 B165	Twelfth positioning deceleration time	5 s	0.01 to 360 s	
1268 B166	Twelfth positioning dwell time	0 ms	0 to 20000 ms	
1269 B167	Twelfth positioning sub-function	10	0 to 2, 10 to 12, 100 to 102, 110 to 112	
1270 B168	Thirteenth positioning acceleration time	5 s	0.01 to 360 s	Set the characteristics of the point table 13.
1271 B169	Thirteenth positioning deceleration time	5 s	0.01 to 360 s	
1272 B170	Thirteenth positioning dwell time	0 ms	0 to 20000 ms	
1273 B171	Thirteenth positioning sub-function	10	0 to 2, 10 to 12, 100 to 102, 110 to 112	

Pr.	Name	Initial value	Setting range	Description
1274 B172	Fourteenth positioning acceleration time	5 s	0.01 to 360 s	Set the characteristics of the point table 14.
1275 B173	Fourteenth positioning deceleration time	5 s	0.01 to 360 s	
1276 B174	Fourteenth positioning dwell time	0 ms	0 to 20000 ms	
1277 B175	Fourteenth positioning sub-function	10	0 to 2, 10 to 12, 100 to 102, 110 to 112	
1278 B176	Fifteenth positioning acceleration time	5 s	0.01 to 360 s	Set the characteristics of the point table 15.
1279 B177	Fifteenth positioning deceleration time	5 s	0.01 to 360 s	
1280 B178	Fifteenth positioning dwell time	0 ms	0 to 20000 ms	
1281 B179	Fifteenth positioning sub-function	10	0, 2, 10, 12, 100, 102, 110, 112	
1282 B180	Home position return method selection	4	0	Dog type
			1	Count type
			2	Data set type
			3	Stopper type
			4	Ignoring the home position (servo-ON position as the home position)
			5	Dog type back end reference
6	Count type with front end reference			
1283 B181	Home position return speed	2 Hz	0 to 30 Hz	Set the speed for the home position return operation.
1284 B182	Home position return shifting speed	0.5 Hz	0 to 10 Hz	Set the speed immediately before the home position return.
1285 B183	Home position shift amount lower 4 digits	0	0 to 9999	Set the home position shift distance. Home position shift amount = <b>Pr.1286</b> × 10000 digits + <b>Pr.1285</b>
1286 B184	Home position shift amount upper 4 digits	0	0 to 9999	
1287 B185	Travel distance after proximity dog ON lower 4 digits	2048	0 to 9999	Set the travel distance after detecting the proximity dog. Travel distance after proximity dog = <b>Pr.1288</b> × 10000 + <b>Pr.1287</b>
1288 B186	Travel distance after proximity dog ON upper 4 digits	0	0 to 9999	
1289 B187	Home position return stopper torque	40%	0 to 200%	Set the activation level of torque limit operation for the stopper-type home position return.
1290 B188	Home position return stopper waiting time	0.5 s	0 to 10 s	Set the waiting time until home position return is started after the inverter detects the pressing status.
1292 B190	Position control terminal input selection	0	0	Sudden stop signal (X87) normally open input (NO contact input)
			1	Sudden stop signal (X87) normally closed input (NC contact input)
1293 B191	Roll feeding mode selection	0	0	Roll feed disabled
			1	Roll feed enabled

\*1 During position control under Vector control, if **Pr.419** = "1" while the FR-A8AL is not installed (or is disabled), a protective function (E.OPT) is activated.

## ◆ Selecting the position command input method (Pr.419)

- Use **Pr.419** to set simple position control by point table.
- Settings are available for the home position data at servo-OFF, clearing of the current position 2 monitor value, and the absolute position control.

Item	Description
Position command	The position command input method can be selected.
Home position retention	Select whether to retain the home position data when the LX signal is OFF (servo-OFF).
Monitor value clearing	Select whether to clear the current position 2 monitor value when the home position return is completed or when position control is switched to other control mode.
Absolute position control	Select the availability of absolute position control.

Pr.419 setting	Position command	Home position retention	Monitor value clearing <sup>*1</sup>		Absolute position control
			When home position return is completed	When position control is switched to other control mode	
0	Simple position control by point table (position command given by setting parameters)	Not retained	Not cleared	Cleared	Disabled
1	Position command given by the pulse train input to the FR-A8AL <sup>*2</sup>				
2	Simple pulse train position command given by the pulse train input to the inverter				
10	Simple position control by point table (position command given by setting parameters)	Retained	Cleared	Cleared	
100		Not retained			
110		Retained	Not cleared	Not cleared	
200		Not retained			
210		Retained	Cleared	Not cleared	
300		Not retained			
310		Retained	Cleared	Cleared	
1110			Cleared	Cleared	
1310			Cleared	Not cleared	

\*1 Timing to clear the current position 2 monitor value differs depending on the setting value. (Refer to page 321.)

\*2 During position control under Vector control, if Pr.419 = "1" while the FR-A8AL is not installed (or is disabled), a protective function (E.OPT) is activated.

\*3 During position control under Vector control, if Pr.419 = "1110 or 1310" while the FR-A8APS is not installed (or is disabled), a protective function (E.OPT) is activated.

## ◆ Positioning by a point table (Pr.4 to Pr.6, Pr.24 to Pr.27, Pr.232 to Pr.239, Pr.465 to Pr.494, and Pr.1222 to Pr.1281)

- Create a the point table by setting the following parameters.

Point table	Position data [Command side]		Maximum speed	Acceleration time	Deceleration time	Dwell time	Auxiliary function	Point table selection signal			
	Upper	Lower						REX	RH	RM	RL
1	Pr.466	Pr.465	Pr.4	Pr.1222	Pr.1223	Pr.1224	Pr.1225	OFF	ON	OFF	OFF
2	Pr.468	Pr.467	Pr.5	Pr.1226	Pr.1227	Pr.1228	Pr.1229	OFF	OFF	ON	OFF
3	Pr.470	Pr.469	Pr.6	Pr.1230	Pr.1231	Pr.1232	Pr.1233	OFF	OFF	OFF	ON
4	Pr.472	Pr.471	Pr.24	Pr.1234	Pr.1235	Pr.1236	Pr.1237	OFF	OFF	ON	ON
5	Pr.474	Pr.473	Pr.25	Pr.1238	Pr.1239	Pr.1240	Pr.1241	OFF	ON	OFF	ON
6	Pr.476	Pr.475	Pr.26	Pr.1242	Pr.1243	Pr.1244	Pr.1245	OFF	ON	ON	OFF
7	Pr.478	Pr.477	Pr.27	Pr.1246	Pr.1247	Pr.1248	Pr.1249	OFF	ON	ON	ON
8	Pr.480	Pr.479	Pr.232	Pr.1250	Pr.1251	Pr.1252	Pr.1253	ON	OFF	OFF	OFF
9	Pr.482	Pr.481	Pr.233	Pr.1254	Pr.1255	Pr.1256	Pr.1257	ON	OFF	OFF	ON
10	Pr.484	Pr.483	Pr.234	Pr.1258	Pr.1259	Pr.1260	Pr.1261	ON	OFF	ON	OFF
11	Pr.486	Pr.485	Pr.235	Pr.1262	Pr.1263	Pr.1264	Pr.1265	ON	OFF	ON	ON
12	Pr.488	Pr.487	Pr.236	Pr.1266	Pr.1267	Pr.1268	Pr.1269	ON	ON	OFF	OFF
13	Pr.490	Pr.489	Pr.237	Pr.1270	Pr.1271	Pr.1272	Pr.1273	ON	ON	OFF	ON
14	Pr.492	Pr.491	Pr.238	Pr.1274	Pr.1275	Pr.1276	Pr.1277	ON	ON	ON	OFF
15	Pr.494	Pr.493	Pr.239	Pr.1278	Pr.1279	Pr.1280	Pr.1281	ON	ON	ON	ON

## ◆ Position data settings

- Set the position feed length to Pr.465 to Pr.494.
- The feed length set to each point table is selected by multi-speed terminals (RH, RM, RL and REX).
- Under Vector control with encoder, set the value calculated with the following formula as the position feed length: (encoder resolution × number of rotations × 4).
- For example, to stop the motor after 100 times of rotations using the SF-V5RU,

The value is calculated with 2048 (pulses/rev) × 100 (rotations per minute) × 4 (multiplier) = 819200 (feed length)



To set 819200 as the first feed length, separate the number into the upper and lower 4 digits as follows:

**Pr.466** (upper digits) = 81 (decimal), **Pr.465** (lower digits) = 9200 (decimal)

- The position feed length of PM sensorless vector control is fixed at 4096 for each motor rotation.

## ◆ Acceleration/deceleration time setting

- Set the acceleration/deceleration time for parameters corresponding to each point table.
- The frequency which is the basis of acceleration/deceleration time is **Pr.20 Acceleration/deceleration reference frequency**. However, 1 Hz/s is the minimum acceleration/deceleration rate (acceleration/deceleration frequency divided by acceleration/deceleration time). If the acceleration/deceleration rate is smaller than 1, the motor runs at 1 Hz/s or in the deceleration time.
- The maximum acceleration/deceleration time is limited at 360 seconds.
- During position control, acceleration/deceleration pattern is always the liner acceleration/deceleration, and the **Pr.29 Acceleration/deceleration pattern selection** setting is ignored.

## ◆ Setting the waiting (dwell) time

- Set the waiting (dwell) time which is the interval from the completion of the position command of a selected point table to the start of the position command of the next point table.
- Set the dwell time from 0 to 20000 ms for parameters corresponding to each point table.

## ◆ Auxiliary function setting

- Set the handling and operation methods of the position data in each point table.
- Set the auxiliary function for parameters corresponding to each point table.

Auxiliary function parameter setting	Sign (100s digit)	Command method (tens place)	Operation method (ones place)
0	Plus (0)	Absolute position command (0)	Individual (0)
1			Continuous (1)
2			Loop operation using the point table selected at the start of the operation (2)
10		Incremental position command (1)	Individual (0)
11			Continuous (1)
12			Loop operation using the point table selected at the start of the operation (2)
100	Minus (1)	Absolute position command (0)	Individual (0)
101			Continuous (1)
102			Loop operation using the point table selected at the start of the operation (2)
110		Incremental position command (1)	Individual (0)
111			Continuous (1)
112			Loop operation using the point table selected at the start of the operation (2)

- For the sign, select the sign of position data.
- For the command method, select the absolute position command or incremental position command. For the absolute position command, specify the distance from the home position. For the incremental position command, specify the distance from the current position command.
- Position commands cannot be received until the completion of the home position return.
- For the operation method, select "individual", "continuous", or "loop operation using the point table selected at the start". When continuous operation is selected, next point table is executed after a command has been executed. Set "individual" as the operation method for the point table which is the last of the continuous operation. When "loop operation using the point table selected at the start" is selected, the positioning operation is the loop. To stop the operation, turn OFF the STF (STR) signal, or turn ON the X87 (sudden stop) input signal.
- Individual operation is only executed in the selected point table. The dwell time setting is disabled in individual operation.
- Continuous operation setting is not available for the point table 15 ("0, 2, 10, 12, 100, 102, 110 or 112" can be set to **Pr.1281**).

## ◆ Example 1 of positioning operation using point table (automatic continuous positioning operation)

The following figure shows an operation example using the following point table.

Point table	Target position		Maximum speed (Hz)	Acceleration time(s)	Deceleration time(s)	Dwell time (ms)	Auxiliary function
	Upper	Lower					
1	100	0	60	5	5	1000	1 (absolute position, continuous)
2	50	0	30	6	6	0	10 (incremental position, individual)

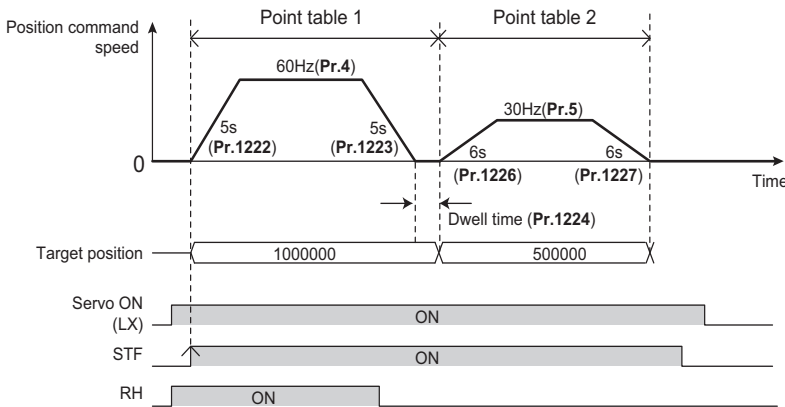

### NOTE

- During continuous operation, the position command speed drops to 0 in each point table operation before starting the next point table operation.
- During continuous operation, no point table selection signal is received. Select the position feed length using point table before turning ON the start command. Only the maximum frequency can be changed during operation.

## ◆ Example 2 of positioning operation using point table (Automatic loop positioning operation using the point table selected at the start of the operation)

The following figure shows a loop operation example using the point table 2 to point table 4 in the following point table. The operation is started from the point table 2 (start point). Set "12" in the auxiliary function of the point table 4 (end point).

Point table	Target position	Maximum speed (Hz)	Acceleration time (s)	Deceleration time (s)	Dwell time (ms) <sup>*1</sup>	Auxiliary function
1	50000	60	1	1	100	1 (absolute position, continuous)
2	70000	20	2	2	100	11 (incremental position, continuous)
3	100000	10	4	4	100	1 (absolute position, continuous)
4	60000	5	3	3	100	12 (incremental position, continuous)

\*1 The positioning operation is the loop. To stop the operation, turn OFF the STF (STR) signal, or turn ON the X87 (sudden stop) input signal.

Operation:

1. The operation is started from the point table 2 (start point).
2. The operation is switched to the one using the point table 3.
3. The operation is switched to the one using the point table 4 (end point).
4. According to the setting in the auxiliary function 2 for the point table 4 (**Pr.1237** = "12"), the operation is switched to the one using the point table 2 selected at the start (loops back to the start point from the end point).

**5.** The loop of operations 1 to 4 executes.

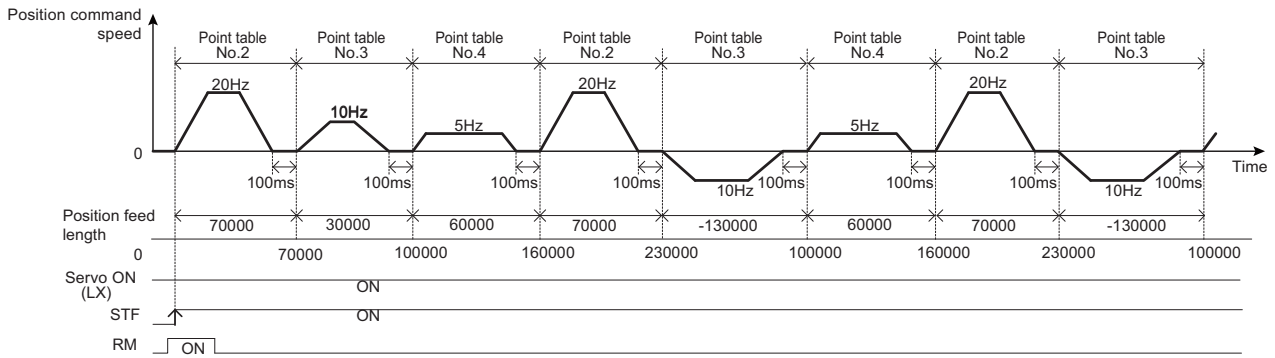

**◆ Example 3 of positioning operation using point table (variable speed operation)**

- The maximum frequency can be changed during positioning operation. Use as many point tables as the number of maximum speeds to be set.
- The following figure shows an operation example using the following point table.

Point table	Target position		Maximum speed (Hz)	Acceleration time (s)	Deceleration time (s)	Dwell time (ms)	Auxiliary function
	Upper	Lower					
1	5	0	30	1	1	0	1 (absolute position, continuous)
2	3	0	20	Invalid	Invalid	0	11 (incremental position, individual)
3	10	0	10	Invalid	Invalid	0	1 (absolute position, continuous)
4	6	0	5	Invalid	Invalid	0	10 (incremental position, individual)

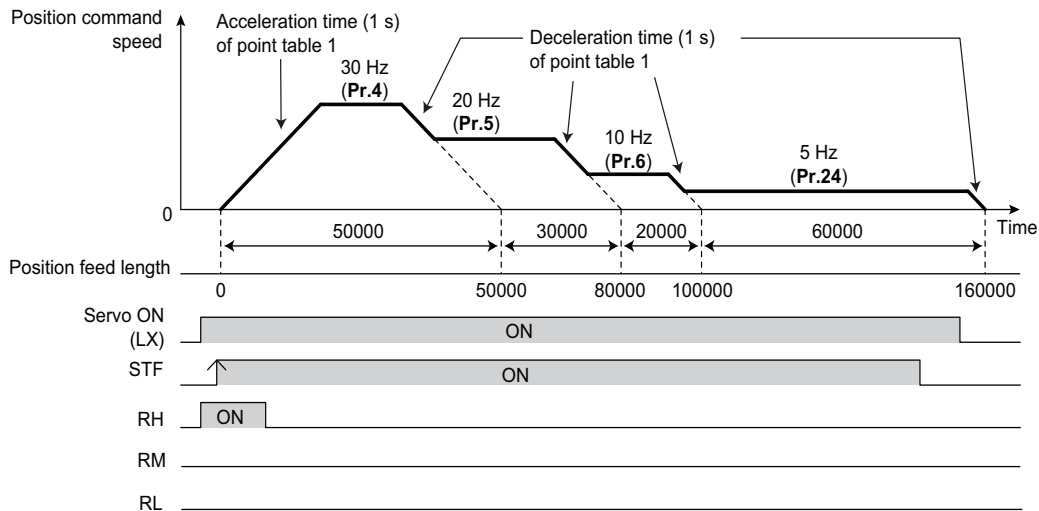

- Set "0" as the dwell time to perform variable speed operation.

**◆ Return to home position during point table positioning**

- Home position return is performed to match the command coordinates with the machine coordinates.
- The returned home position can be set as point 0, and positioning operation is available using this.

**■ Home position return procedure**

- 1.** Set parameters related to home position return.

- Set the home position return method (**Pr.1282**).
- Set the home position return speed (**Pr.1283**)
- Set the home position creep speed (**Pr.1284**)
- Set the home position return shift amount if necessary(**Pr.1286 × 10000 + Pr.1285**).
- Set the post proximity dog travel distance if necessary. (**Pr.1288 × 10000 + Pr.1287**)



2. Turn OFF all point table selections.
  - Turn OFF all RH, RM, RL and REX signals.
3. Turn ON the Pre-excitation/servo ON (LX) signal.
4. Turn ON the start signal (STF or STR).
  - Home position return is performed according to the settings.

**NOTE**

- The setting values of the point table 1 are used as acceleration/deceleration time.
- After turning ON the start signal, only the setting values of **Pr.1283 Home position return speed**, **Pr.1284 Home position return shifting speed** can be changed.
- Perform home position return at the motor switchover.

◆ **Selecting the home position return method (Pr.1282 to Pr.1288)**

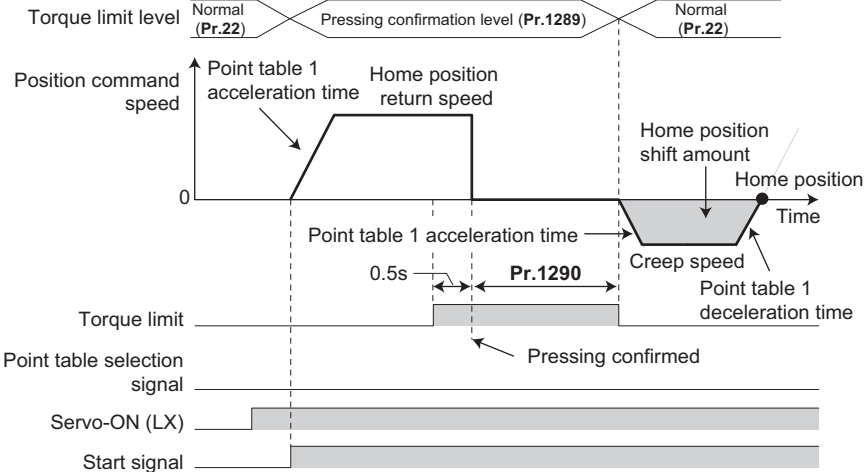
Pr.1282 setting	Home position return method	Description
0	Dog type <sup>*1</sup> <b>Vector</b>	<p>Deceleration starts when the Proximity dog signal is turned ON. For the home position after turn OFF of the Proximity dog signal, the position specified by the first Z-phase signal or the position of the first Z-phase signal shifted by the home position shift amount (<b>Pr.1285, Pr.1286</b>) is used.</p>
1	Count type <sup>*1</sup> <b>Vector</b>	<p>Deceleration starts when the proximity dog signal is turned ON. After the proximity dog, the motor travels the specified travel distance (<b>Pr.1287, Pr.1288</b>). Then, it uses the position specified by the first Z-phase signal or position of the Z-phase signal shifted by the home position shift amount (<b>Pr.1285, Pr.1286</b>).</p>
2	Data set type <b>Vector</b> <b>PM</b>	<p>The position at which the start signal is input is used as the home position.</p>

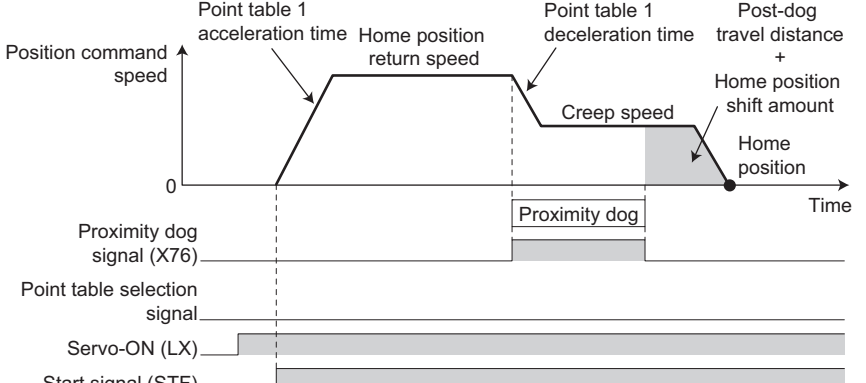
Pr.1282 setting	Home position return method	Description
3	Stopper type <b>Vector</b> <b>PM</b>	<p>A workpiece is pressed to a mechanical stopper, and the position where it is stopped is set as the home position. Pressing is confirmed when the estimated speed value remains equal to or lower than the value set in <b>Pr.865 Low speed detection</b> for 0.5 second during the torque limit operation. (While the stopper-type home position is performed, <b>Pr.1289 Home position return stopper torque</b> is applied.) After <b>Pr.1290 Home position return stopper waiting time</b> has passed after pressing is confirmed, the home position is shifted by the home position shift distance (<b>Pr.1285 and Pr.1286</b>). After a position command is created and the absolute value of the droop pulse (after electronic gear) falls below the in-position width, the home position return is completed.</p>  <p>The diagram shows the speed profile for Method 3. It starts with a 'Normal (Pr.22)' torque limit level. The speed profile includes 'Point table 1 acceleration time', 'Home position return speed', a 0.5s dwell, 'Pr.1290' (Home position return stopper waiting time), 'Creep speed', and 'Point table 1 deceleration time'. Torque limit drops to 'Pressing confirmation level (Pr.1289)' during the 0.5s dwell and returns to 'Normal (Pr.22)' after 'Pr.1290'. Signals include 'Point table selection signal', 'Servo-ON (LX)', and 'Start signal'. The final 'Home position' is shifted by the 'Home position shift amount'.</p>
4 (initial value)	Ignoring the home position (servo ON position as the home position) <b>Vector</b> <b>PM</b>	<p>The servo ON position is used as the home position.</p>  <p>The diagram shows the speed profile for Method 4. The speed is zero until the 'Home position' is reached. Signals include 'Point table selection signal', 'LX', 'STF', and 'RDY'.</p>
5	Dog type back end reference <b>Vector</b> <b>PM</b>	<p>Deceleration starts at the front end of the proximity dog. After the back end is passed, the position is shifted by the post-dog travel distance and home position shift amount. The position after the shifts is set as the home position. Set pulses required for deceleration from the creep speed or more as the total of the post-dog travel distance and home position shift amount.</p>  <p>The diagram shows the speed profile for Method 5. It includes 'Point table 1 acceleration time', 'Home position return speed', 'Point table 1 deceleration time', and 'Creep speed'. The 'Proximity dog' signal is active during the deceleration phase. The final 'Home position' is shifted by the 'Post-dog travel distance + Home position shift amount'. Signals include 'Point table selection signal', 'Servo-ON (LX)', and 'Start signal (STF)'.</p>

Pr.1282 setting	Home position return method	Description
6	Count type with front end reference <b>Vector</b> <b>PM</b>	<p>Deceleration starts at the front end of the proximity dog, and the position is shifted by the post-dog travel distance and home position shift distance. The position after the shifts is set as the home position.</p> <p>Set pulses required for changing the speed from the home position speed to the creep speed or more as the total of the post-dog travel distance and home position shift amount.</p>

\*1 If it is set under PM sensorless vector control, Home position return parameter setting error (HP3) occurs.

### NOTE

- Home position return automatic back-off function

In a system that uses home position return with proximity dog, if the home position return is commanded while the motor is in a position within the proximity dog, the motor moves out of the proximity dog once, then starts deceleration to stop when it comes to the proximity dog again. The home position return is performed automatically after that.

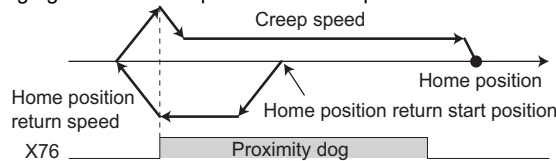

## ◆ Home position return error

- If home position return is not normally completed, the following warnings appear on the operation panel.

Operation panel indication	Name	Possible cause
HP1	Home position return setting error	<ul style="list-style-type: none"> <li>The home position setting has failed.</li> </ul>
HP2	Home position return uncompleted	<ul style="list-style-type: none"> <li>Start signal for the point table positioning has turned ON without completing the home position return.</li> <li>The proximity dog signal is turned OFF during transition from the home position return speed to the creep speed when home position return is performed in the dog type or dog type back end reference.</li> <li>The position command is given for the motor to reach the post-dog travel distance during transition from the home position return speed to the creep speed when home position return is performed in the count type.</li> <li>The position command is given for the motor to reach the total of the post-dog travel distance and home position shift distance during deceleration from the creep speed after the proximity dog signal is turned OFF in the dog type back end reference.</li> <li>The speed did not reach the creep speed in the count type with front end reference.</li> </ul>
HP3	Home position return parameter setting error	<ul style="list-style-type: none"> <li>An unavailable home position return method is selected.</li> </ul>

- The home position return failure (ZA) signal is output while the home position return warning is occurring. To use the ZA signal, set "56 (positive logic) or 156 (negative logic)" in any of **Pr.190 to Pr.196 (Output terminal function selection)** to assign the function.

## ◆ Sudden stop (Pr.464, Pr.1221, and X87 signal)

- The operation performed during STF(STR)-OFF can be selected with **Pr.1221 Start command edge detection selection**.

- If STF (STR) is turned OFF during positioning or home position returning when **Pr.1221** = "0 (initial value)" is set, it stops in the time set as **Pr.464 Digital position control sudden stop deceleration time**.

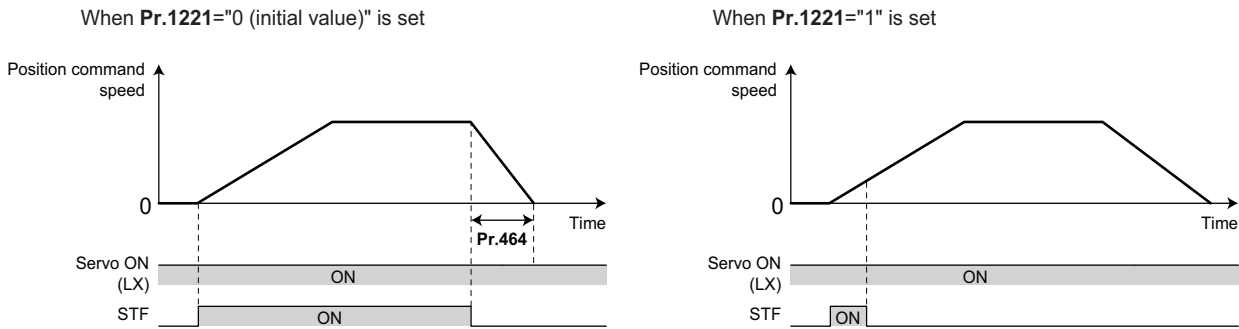

- Turning ON the Sudden stop signal (X87) during positioning operation or home position return operation, the motor stops in the setting time of **Pr.464**. To assign the X87 signal, set "87" in any of **Pr.178 to Pr.189 (Input terminal function selection)**.

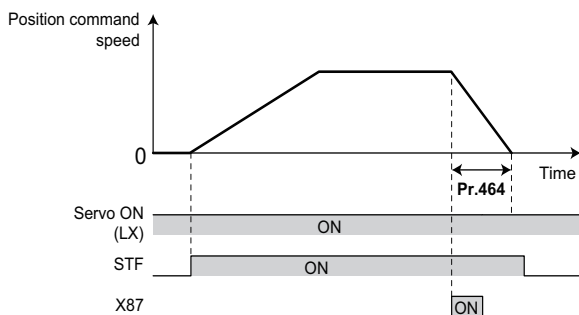

- The input logic of the X87 signal **Pr.1292 Position control terminal input selection** can be set using.

Pr.1292 setting	Input logic (X87)
0 (initial value)	Normally open input (NO contact input specification)
1	Normally closed input (NC contact input specification)

### NOTE

- When deceleration time longer than the normal deceleration time (including **Pr.1223**) is set in **Pr.464**, the normal deceleration time is applied.
- The X87 signal is effective during position control JOG operation.

## ◆ Roll feed mode (Pr.1293)

- If the roll feed mode is enabled in an application that needs repeated positioning in the same direction, such as a conveyor, positioning can be performed repeatedly without position command overflow.
- When the roll feed mode is enabled (**Pr.1293** = "1"), the position where the first position command is created is set as the home position and the droop pulses are cleared.

When **Pr.1293** = "1", simple positioning is available even if home position return cannot be completed.

- Positioning modes which enables the roll feed mode are the point table mode, the home position return mode, and the JOG mode.

• Basic operation example

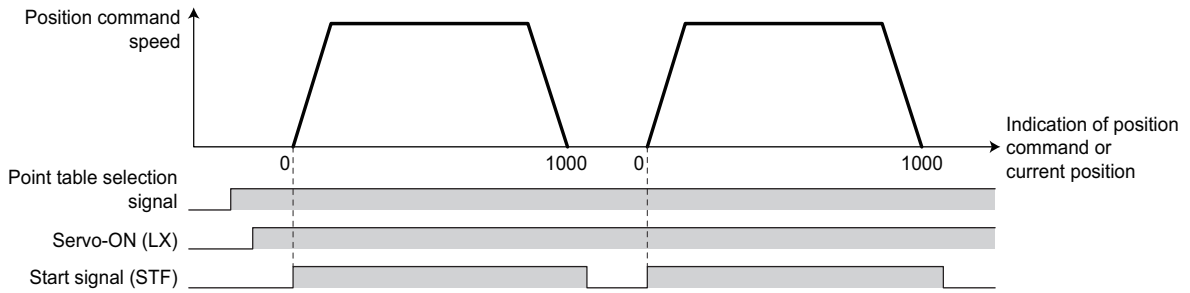

◆ Input/output signals for point table positioning

Input/output	Signal name		Function	Pr.178 to Pr.189 setting	Pr.190 to Pr.196 setting	
					Positive logic	Negative logic
Input	X76	Proximity dog	ON: dog ON, OFF: dog OFF	76	—	
	X87	Sudden stop	When turned ON, the motor decelerates and stops according to <b>Pr.464</b> .	87	—	
Output	MEND	Travel completed	Turns ON when the position command operation has completed while the number of droop pulses is within the positioning completion width.	—	38	138
	ZA	Home position return failure	Turns ON while the home position return warning occurs.	—	56	156
	PBSY	During position command operation	Turns ON during position command operation.	—	61	161
	ZP	Home position return completed	Turns ON after home position return operation is complete.	—	63	163

• Output signal operation during positioning by point table

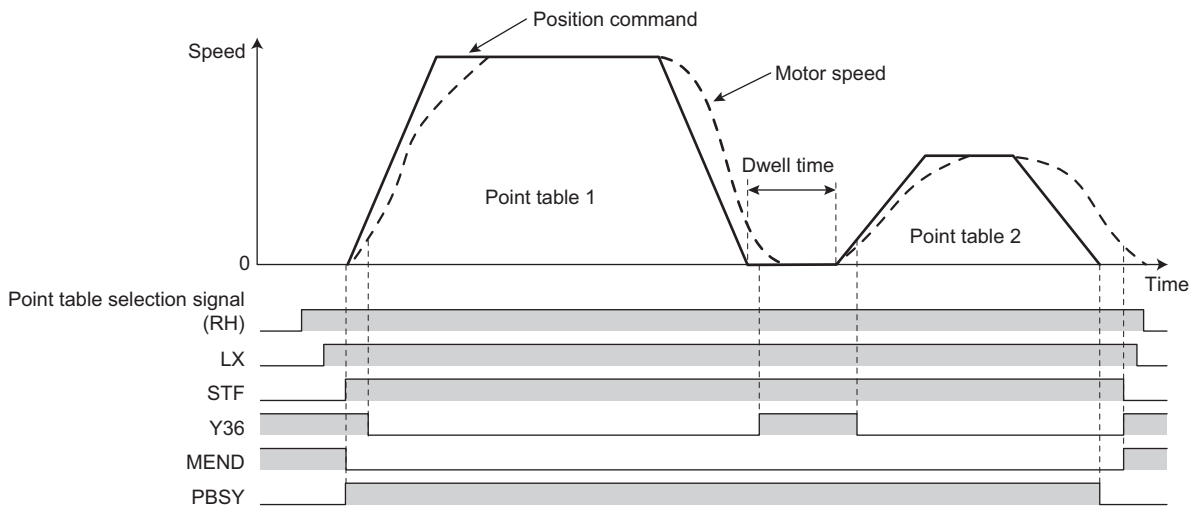



- Output signal operation during positioning with home position return

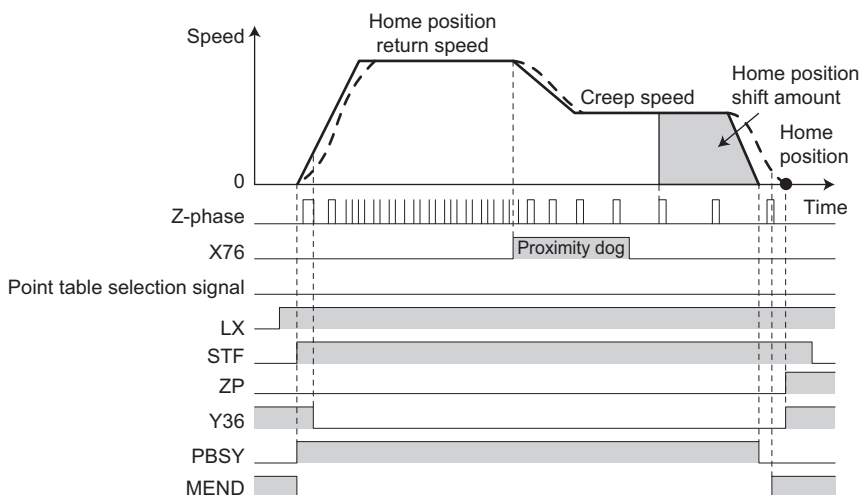

**NOTE**

- When the LX signal is turned OFF, the home position return completed (ZP) signal is turned OFF. When the LX signal is turned ON again while Pr.419 = "10", the ZP signal is also turned ON.

Parameters referred to

Pr.20 Acceleration/deceleration reference frequency [page 367](#)

Pr.29 Acceleration/deceleration pattern selection [page 372](#)

## 5.5.5 Position control by the FR-A8AL pulse train input

Vector PM

Position control by the command from the positioning module of the programmable controller is available using the FR-A8AL.

Pr.	Name	Initial value	Setting range	Description	
419 B000	Position command source selection	0	0, 10, 100, 110, 200, 210, 300, 310, 1110, 1310	Simple position control by point table (Settings are available for the home position data at servo-OFF, clearing of the current position 2 monitor value, and the absolute position control.)	
			1	Position command given by the FR-A8AL pulse train input <sup>*1</sup>	
			2	Simple pulse train position command given by the pulse train input to the inverter	
428 B009	Command pulse selection	0	0	Forward/Reverse pulse train	
			1	Pulse train + rotation direction sign	Negative logic
			2	A/B phase pulse train	
			3	Forward/Reverse pulse train	
			4	Pulse train + rotation direction sign	Positive logic
5	A/B phase pulse train				

\*1 During position control under Vector control, if Pr.419 = "1" while the FR-A8AL is not installed (or is disabled), a protective function (E.OPT) is activated.

## ◆ Connection diagram

- Connection with the positioning module of RD75P type MELSEC iQ-R series is also available.

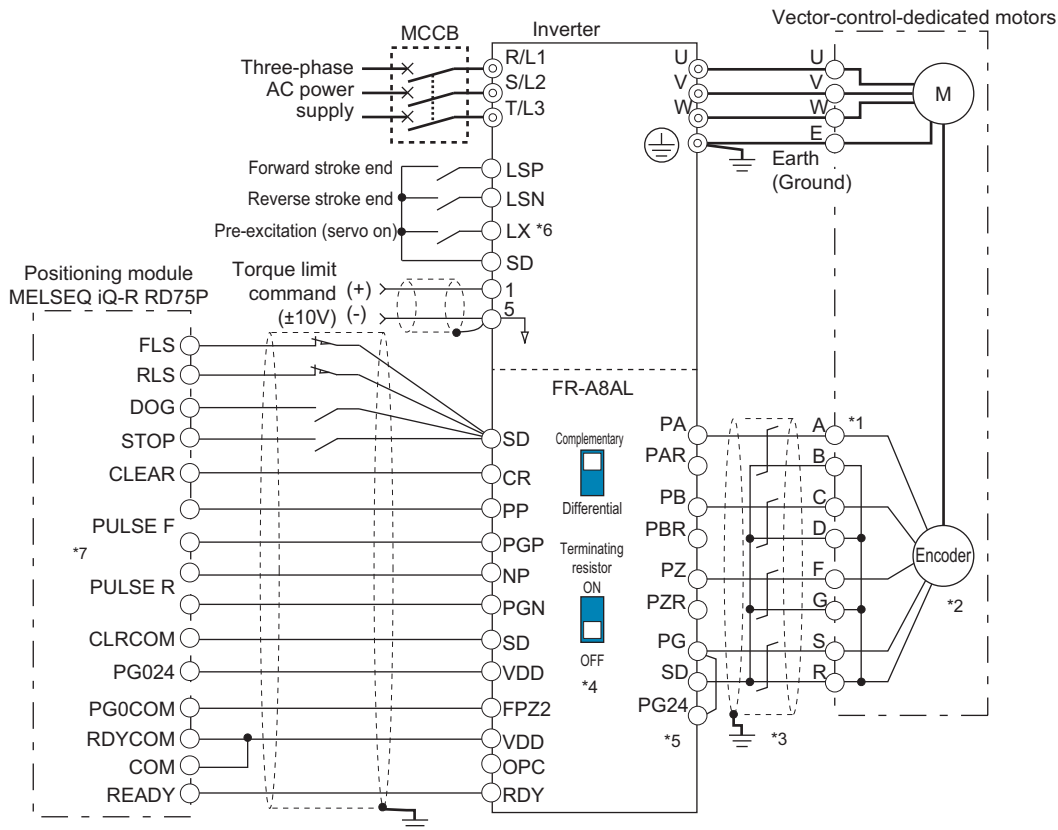

- \*1 The pin number differs according to the encoder used. Speed control, torque control, and position control by pulse train input are available with or without the Z-phase being connected.
- \*2 Connect the encoder so that there is no looseness between the motor and motor shaft. Speed ratio must be 1:1.
- \*3 Earth (ground) the shield of the encoder cable to the enclosure using a tool such as a P-clip. (Refer to [page 87](#).)
- \*4 For the complementary, set the terminating resistor selection switch to the OFF position (initial status). (Refer to [page 87](#).)
- \*5 A separate external power supply of 15 V is necessary according to the encoder power specification. When the encoder output is the differential line driver type, only 5 V can be input. When the 24 V power supply of the FR-A8AL is used, the power is supplied to the encoder through terminal PG24. When the 5 V/12 V power supply of the FR-A8AL is used, the power is supplied to the encoder through terminal PGV. Do not use the external power supply simultaneously with the 5 V/12 V power supply or the 24 V power supply. Make the voltage of the external power supply the same as the encoder output voltage, and connect the external power supply between terminals PG and SD.
- \*6 Assign the function using [Pr.178 to Pr.184](#), [Pr.187 to Pr.189](#) (Input terminal function selection).
- \*7 The pulse signal from the position module is available for both open collector and differential line driver. However, the connections are different. (The following figure shows an example for differential line driver.) For the connection method, refer to the Instruction Manual of the FR-A8AL.

## ◆ Operation outline

- If the pre-excitation/servo ON (LX) signal is turned ON, output shutoff is canceled and the position control preparation ready (RDY) signal is turned ON after 0.1 second. When the LSP signal (forward stroke end) or the LSN signal (reverse stroke end) is turned ON, the motor rotates according to the command pulse. When the forward (reverse) stroke end signal is turned OFF, the motor does not rotate in the corresponding direction.
- To use the LSP or LSN signal, set the corresponding number in the following table in any of [Pr.178 to Pr.189](#) (Input terminal function selection) to assign the function to an input terminal. When the LSP and LSN signals are not assigned, the STF signal is used as the forward stroke end signal, and the STR signal is used as the reverse stroke end signal.

Pr.178 to Pr.189 setting	Signal
88	LSP
89	LSN

- The LSP and LSN signals can be input via an external terminal only regardless of the setting in **Pr.338 Communication operation command source** or **Pr.339 Communication speed command source**.

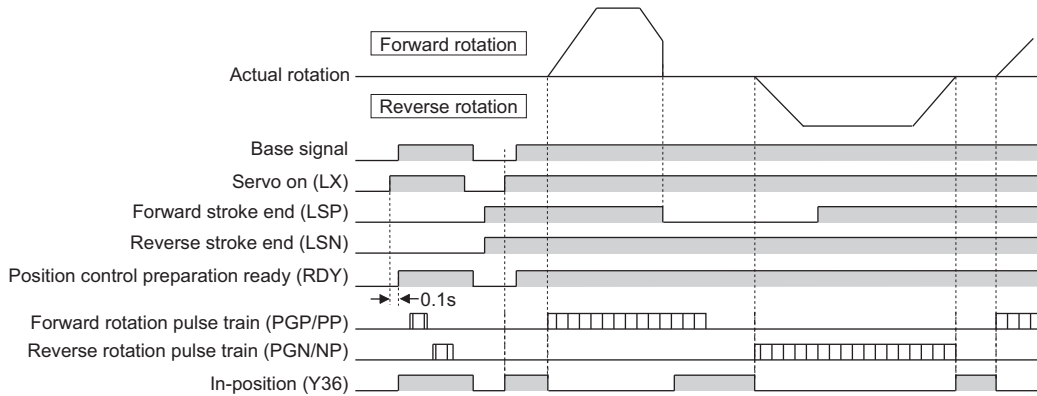

### ◆ Interface between the position module and the inverter.







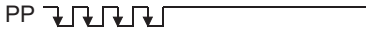

- To operate an inverter using a positioning module, the interfaces for the position command pulse train must agree with each other.

Output form	Hardware	Input pulse frequency
Open collector	<p>*: Wiring length : max. 2 m</p>	Max 200k pulses/s
Differential line driver	<p>*: Wiring length : max. 10 m</p>	Max 500k pulses/s

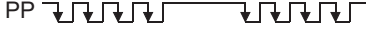
### ◆ Selecting the pulse train type (Pr.428)

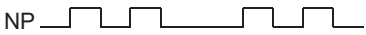
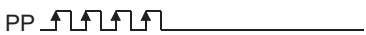
- To select the pulse train input to the FR-A8AL, set "1" in **Pr.419** after installing the FR-A8AL on the inverter.

- The command pulse is switchable according to the position module as shown in the following table.

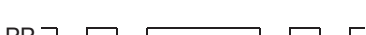
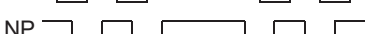
Command pulse train type		During forward rotation	During reverse rotation	Setting of Pr.428	Remarks
Negative logic	Forward pulse train Reverse pulse train	PP  NP 		0 (initial value)	RD75 (CW/CCW mode) Note: When (CW/CCW mode) and (PULSE/SIGN mode) are connected incorrectly, the motor moves only one direction.
	Pulse train + sign	PP  NP  L H		1	RD75 (PULSE/SIGN mode)
	A phase pulse train B phase pulse train	PP  NP 		2	The number of pulses are multiplied by 4 to count. When differential line driver is used, the number of pulses after the number encoder pulses is quadruplicated should be 500k pulses/s or lower. When open collector is used, the number should be 200k pulses/s or lower.
Positive logic	Forward pulse train Reverse pulse train	PP  NP 		3	
	Pulse train + sign	PP  NP  H L		4	
	A phase pulse train B phase pulse train	PP  NP 		5	The number of pulses are multiplied by 4 to count. When differential line driver is used, the number of pulses after the number encoder pulses is quadruplicated should be 500k pulses/s or lower. When open collector is used, the number should be 200k pulses/s or lower.

## 5.5.6 Position control by pulse train input to the inverter

Vector PM

The simple position pulse train command can be input by pulse train input and simple position pulse train signal (NP) to the JOG terminal.

Pr.	Name	Initial value	Setting range	Description
419 B000	Position command source selection	0	0, 10, 100, 110, 200, 210, 300, 310, 1110, 1310	Simple position control by point table (Settings are available for the home position data at servo-OFF, clearing of the current position 2 monitor value, and the absolute position control.)
			1	Position command given by the FR-A8AL pulse train input
			2	Simple pulse train position command given by the pulse train input to the inverter
428 B009	Command pulse selection	0	0 to 2	Pulse train + rotation direction
			3 to 5	sign
				Negative logic
				Positive logic

### ◆ Operation outline

- If the Pre-excitation/servo ON (LX) signal is turned ON, output shutoff is canceled and the Position control preparation ready (RDY) signal is turned ON after 0.1 second. When the LSP signal (forward stroke end) or the LSN signal (reverse stroke end) is turned ON, the motor rotates according to the command pulse. When the forward (reverse) stroke end signal is turned OFF, the motor does not rotate in the corresponding direction.
- To use the LSP or LSN signal, set the corresponding number in the following table in any of **Pr.178 to Pr.189 (Input terminal function selection)** to assign the function to an input terminal. When the LSP and LSN signals are not assigned, the STF signal is used as the forward stroke end signal, and the STR signal is used as the reverse stroke end signal.

Pr.178 to Pr.189 setting	Signal
88	LSP
89	LSN

- The LSP and LSN signals can be input via an external terminal only regardless of the setting in **Pr.338 Communication operation command source** or **Pr.339 Communication speed command source**.

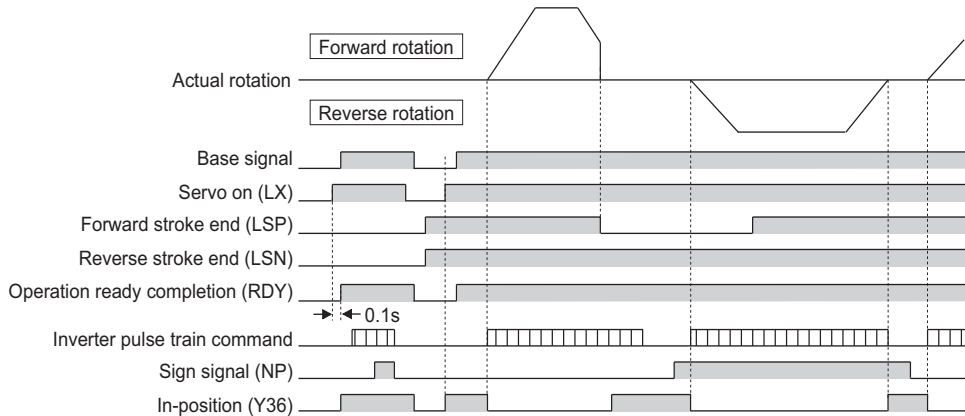

## ◆ Selecting the pulse train type (Pr.428 and NP signal)

- Set **Pr.419 Position command source selection** = "2" (simple pulse train position command).
- Set "68" in any of **Pr.178 to Pr.189 (Input terminal function selection)** to assign the Simple position pulse train sign (NP) to the input terminal.
- Select the command pulse train with **Pr.428 Command pulse selection**.

Pr.428 setting	Command pulse train type	During forward rotation	During reverse rotation
0 to 2	Negative logic Pulse train + rotation direction sign	JOG  NP	JOG  NP
3 to 5	Positive logic Pulse train + rotation direction sign	JOG  NP	JOG  NP

- Select Vector control or PM sensorless vector control to select the position control method.

### NOTE

- If **Pr.419** = "2" (simple pulse train position command) is set, terminal JOG is used for the simple position pulse train input regardless of the **Pr.291 Pulse train I/O selection** pulse train input/output selection setting.

## 5.5.7 Clear signal selection

Pr.	Name	Initial value	Setting range	Description
429 B010	Clear signal selection	1	0	The values of the position pulse (command pulse, droop pulse, current position, and current position 2) are cleared at the rising edge when the clear (CLR/CLRN) signal is switched from OFF to ON.
			1	The values of the position pulse are cleared while the clear (CLR/CLRN) signal is turned ON.

- This function is useful to reset the number of droop pulses to 0 when home position return is performed.
- The Simple position droop pulse clear (CLR) signal is valid when the inverter is in the External operation mode. The NET position pulse clear (CLRN) signal is valid when the inverter is in the Network operation mode (not applicable when the FR-A8NS is installed).
- If the simple position droop pulse clear (CLR) signal is turned ON when **Pr.429 Clear signal selection** = "0", the deviation counter is cleared at the edge of the signal. The CLR/CLRN signal is also turned ON in synchronization with the zero pulse signal of the encoder such as the home position return signal, and the deviation counter is cleared.
- For a terminal used for the CLR signal, set "69" in any of **Pr.178 to Pr.189 (Input terminal function selection)** to assign the function.

- For a terminal used for the CLR signal, set "59" in any of **Pr.178 to Pr.189 (Input terminal function selection)** to assign the function.

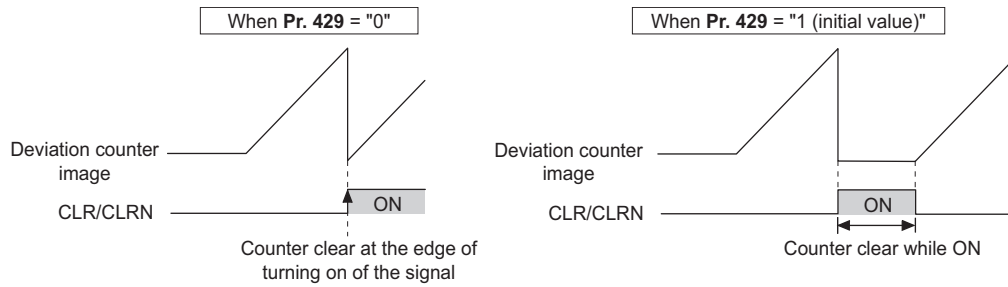

### NOTE

- The accumulated number of pulses is cleared at base shutoff or when the CLR/CLRN signal is turned ON.
- Refer to [page 321](#) for the condition to clear the values of the position pulse.
- Changing the terminal assignment using **Pr.178 to Pr.189 (Input terminal function selection)** may affect the other functions. Set parameters after confirming the function of each terminal.

### Parameters referred to

Pr.178 to Pr.189 (Input terminal function selection) [page 521](#)

## 5.5.8 Pulse monitor

Vector PM

Various pulses can be monitored.

Pr.	Name	Initial value	Setting range	Description
430 B011	Pulse monitor selection	9999	0 to 5, 12, 13, 100 to 105, 112, 113, 1000 to 1005, 1012, 1013, 1100 to 1105, 1112, 1113, 2000 to 2005, 2012, 2013, 2100 to 2105, 2112, 2113, 3000 to 3005, 3012, 3013, 3100 to 3105, 3112, 3113	Shows the various pulse conditions during operation as the number of pulses.
			8888, 9999	Shows the frequency monitor.
635 <sup>*1</sup> M610	Cumulative pulse clear signal selection	0	0 to 3	Select the clearing method for the cumulative pulse monitor.
636 <sup>*1</sup> M611	Cumulative pulse division scaling factor	1	1 to 16384	Set the division scaling factor on the cumulative pulse for the Vector control compatible plug-in option.
637 <sup>*1</sup> M612	Control terminal option-Cumulative pulse division scaling factor	1	1 to 16384	Set the division scaling factor on the cumulative pulse for the control terminal option (FR-A8TP).
638 <sup>*1</sup> M613	Cumulative pulse storage	0	0 to 3	Select the processing method for the cumulative pulse monitor value when the power is turned OFF or the inverter is reset.

\*1 The setting is available when a Vector control compatible option is installed.

### ◆ Pulse monitor selection (Pr.430)

- Shows the various pulse conditions during operation as the number of pulses. Set "0" in **Pr.52 Operation panel main monitor selection** to display the output frequency monitor.

- Also, setting "26 to 31" in **Pr.52, Pr.774 to Pr.776, Pr.992** (multifunction monitor) changes the electronic gear operation setting in the case of monitoring pulses. (Refer to [page 446](#).)

Pr.430 setting	Description	
0000	Pulse monitor selection	Displays the lower of the position command (accumulated value of command pulses).
0001		Displays the upper of the position command (accumulated value of command pulses).
0002		Displays the lower of the current position (accumulated value of feedback pulses <sup>*1</sup> ).
0003		Displays the upper of the current position (accumulated value of feedback pulses <sup>*1</sup> ).
0004		Displays the lower of the accumulated value of droop pulses.
0005		Displays the upper of the accumulated value of droop pulses.
0012		Displays the lower of the current position 2 (accumulated value of feedback pulses <sup>*1</sup> ).
0013		Displays the upper of the current position 2 (accumulated value of feedback pulses <sup>*1</sup> ).
0000	For pulse monitor selection	Displays the monitor item selected in the pulse monitor selection after the electronic gear operation.
0100		Displays the monitor item selected in the pulse monitor selection before the electronic gear operation.
0000	For the multifunction monitor / PLC function special register	Displays the monitor item selected in the multifunction monitor (position command, current position, and droop pulse) before the electronic gear operation.
		Displays the item in the PLC function special register (position command, current position, droop pulse, and current position 2) before the electronic gear operation.
1000		Displays the monitor item selected in the multifunction monitor (position command, current position, and droop pulse) after the electronic gear operation.
		Displays the item in the PLC function special register (position command, current position, droop pulse, and current position 2) after the electronic gear operation.
2000		Displays the monitor item selected in the multifunction monitor (position command, current position, and droop pulse) before the electronic gear operation.
		Displays the item in the PLC function special register (position command, current position, droop pulse, and current position 2) before the electronic gear operation.
3000		Displays the monitor item selected in the multifunction monitor (position command, current position, and droop pulse) after the electronic gear operation.
		Displays the item in the PLC function special register (position command, current position, droop pulse, and current position 2) after the electronic gear operation.
8888	Output frequency display	Displays the monitor item selected in the multifunction monitor (position command, current position, and droop pulse) after the electronic gear operation.
		Displays the item in the PLC function special register (position command, current position, droop pulse, and current position 2) after the electronic gear operation.
9999		Displays the monitor item selected in the multifunction monitor (position command, current position, and droop pulse) before the electronic gear operation.
		Displays the item in the PLC function special register (position command, current position, droop pulse, and current position 2) before the electronic gear operation.

\*1 Accumulated value of estimated feedback pulses when PM sensorless vector control is used

- Position pulses are cleared according to the following conditions.

Clearing condition	Position command / current position / droop pulse			
	Pr.419 setting			
	0, 100, 200, 300	10, 110, 210, 310	1, 2	1110, 1310
Servo-OFF (LX-OFF) (output shutoff)	○	×	○	×
Clear signal input <sup>*2</sup>	○	○ <sup>*3</sup>	○	×
Home position return completed	○ <sup>*1</sup>	○ <sup>*1*4</sup>	— <sup>*6</sup>	○ <sup>*1*4</sup>
When position control is switched to other control mode	○	○	○	○
Clear signal input (under the control mode other than position control)	×	×	×	×

Clearing condition	Current position 2											
	Pr.419 setting											
	0	10	100	110	1, 2	1110	200	210	300	310	1310	
Servo-OFF (LX-OFF) (output shutoff)	x	x	x	x	x	x	x	x	x	x	x	x
Clear signal input <sup>*2</sup>	o	o <sup>*3</sup>	o	o <sup>*3</sup>	o	x <sup>*5</sup>	o	o	o	o	o	x <sup>*5</sup>
Home position return completed	x	x	o	o	— <sup>*6</sup>	o	x	x	o	o	o	o
When position control is switched to other control mode	o	o	o	o	o	o	x <sup>*7</sup>	x <sup>*7</sup>	x <sup>*7</sup>	x <sup>*7</sup>	x <sup>*7</sup>	x <sup>*7</sup>
Clear signal input (under the control mode other than position control)	x	x	x	x	x	x	o <sup>*7</sup>	o <sup>*7</sup>	o <sup>*7</sup>	o <sup>*7</sup>	o <sup>*7</sup>	o <sup>*7</sup>

o: cleared, x: not cleared

\*1 The droop pulses are not cleared.

\*2 The CLR/CLRN signal is input when a value other than "1" is set in Pr.419, and the signal is input through terminal CR of the FR-A8AL when Pr.419 = "1".

\*3 Pulses are cleared when a clear signal is input. (The home position information is not retained.)

\*4 Pulses are cleared only when the home position return is completed. Once the pulses are cleared, they are not cleared even if the LX signal is turned ON.

\*5 The data is cleared when absolute position control is disabled.

\*6 The home position return is not available.

\*7 The following shows the example of the clearing the value of the current position 2 monitor under the control mode other than the position control mode.

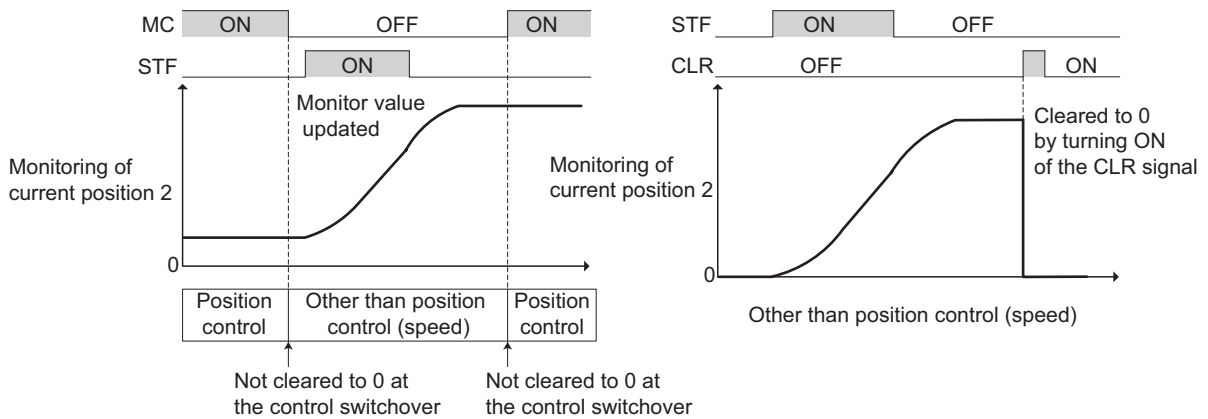

**NOTE**

- The monitor value of the current position 2 is not cleared when switching between the first and second motors.
- For details on the special register for the PLC function, refer to the PLC Function Programming Manual.

**◆ Pulse monitoring on the operation panel (FR-DU08)**

- The position command, current position and the status of droop pulses can be displayed on the operation panel.
- If displayed data has signs, minus signs appear for both upper and lower digits.
- If -99999999 or 99999999 is exceeded on the pulse monitor, the monitor value is reset to 0.

Display data		Monitor display without signs	Monitor display with signs
-10000	Lower monitor	0000	--0000
	Upper monitor	1	-- 1
-100	Lower monitor	100	-- 100
	Upper monitor	0	-- 0

**NOTE**

- The pulse count starts at servo on.



## ◆ Cumulative pulse monitoring

- When the Vector control compatible plug-in option or the control terminal option (FR-A8TP) is used, the accumulated value of the encoder pulses can be monitored.
- The cumulative pulse monitor is available when "71 to 74" is set in the monitor selection parameters (**Pr.52, Pr.774, Pr.775, Pr.776, and Pr.992**).

Monitor item	Pr.52, Pr.774 to Pr.776, Pr.992	Display with minus sign	Description
Cumulative pulse	71	○*1	The cumulative number of pulses is displayed (for Vector control compatible plug-in option). (Monitoring range: -32767 to 32767)
Cumulative pulse overflow times	72	○*1	The number of the cumulative pulses carrying overflow times is displayed (for Vector control compatible plug-in option).
Cumulative pulse (control terminal option)	73	○*1	The cumulative number of pulses is displayed (for the FR-A8TP). (Monitoring range: -32767 to 32767)
Cumulative pulse overflow times (control terminal option)	74	○*1	The number of the cumulative pulse overflow times is displayed (for FR-A8TP).

\*1 Negative values are not displayed on the operation panel. The values "-1 to -32767" are displayed as "65535 to 32769" on the operation panel.

## ◆ Cumulative pulse division scaling factor (Pr.636, Pr.637)

- Set the division scaling factor on the cumulative pulse in **Pr.636** or **Pr.637**.
- Cumulative pulse count value calculation method  

$$\text{Cumulative pulse count value} = \text{Cumulative pulse division scaling factor} \times (\text{Cumulative pulse overflow times} \times 32768 + \text{Cumulative pulse monitor value})$$
- Cumulative pulse count value: Number of pulses multiplied by 4
- Cumulative pulse division scaling factor: **Pr.636, Pr.637**

## ◆ Cumulative pulse monitor value clear (Pr.635)

- The cumulative pulse monitor and the cumulative pulse overflow times can be cleared by X52 signal or X53 signal.
- To input the X52 or X53 signal, set "52 (X52)" or "53 (X53)" in any of **Pr.178 to Pr.189 (Input terminal function selection)** to assign the function to a terminal.
- Use **Pr.635 Cumulative pulse division scaling factor** to select the clearance method for the cumulative pulse monitor and the cumulative pulse overflow times.

Pr.635 setting	X52 signal	X53 signal
	Cumulative pulse monitor value clear	Cumulative pulse monitor clear (control terminal option)
0	Cleared at the edge when the signal is switched to ON.	Cleared at the edge when the signal is switched to ON.
1	Cleared while the signal is ON.	Cleared at the edge when the signal is switched to ON.
2	Cleared at the edge when the signal is switched to ON.	Cleared while the signal is ON.
3	Cleared while the signal is ON.	Cleared while the signal is ON.

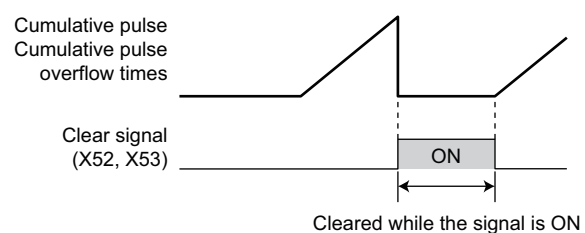
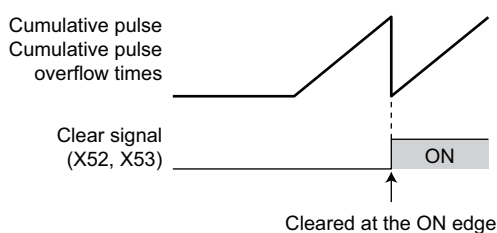

## ◆ Cumulative pulse storage

- The cumulative pulse monitor value and cumulative pulse overflow times can be retained when the power is turned OFF or the inverter is reset.

Pr.638 setting	Cumulative pulse monitor / Cumulative pulse overflow times		Cumulative pulse monitor / Cumulative pulse overflow times (Control terminal option)	
	At power-OFF	At reset	At power-OFF	At reset
0	Not stored in the EEPROM	Cleared	Not stored in the EEPROM	Cleared
1	Stored in the EEPROM	Retained	Not stored in the EEPROM	Cleared
2	Not stored in the EEPROM	Cleared	Stored in the EEPROM	Retained
3	Stored in the EEPROM	Retained	Stored in the EEPROM	Retained

**NOTE**

- When the power is turned OFF during the reset process, the cumulative pulse monitor value and the cumulative pulse overflow times are not stored in the EEPROM.
- For storing the cumulative pulse monitor value and the cumulative pulse overflow times in the EEPROM at power OFF, connect R1/L11 with P/+, and S1/L21 with N/- so that the control power is retained. When connecting the FR-HC2 high power factor converter or the converter unit (FR-CC2), assign the FR-HC2/FR-CC2 instantaneous power failure detection (X11) signal to an input terminal to input the IPF signal from the FR-HC2/FR-CC2 to the terminal for X11 signal.

« Parameters referred to »

Pr.52 Operation panel main monitor selection  page 446

## 5.5.9 Electronic gear settings

**Vector** **PM**

Set the gear ratio between the machine gear and motor gear.

Pr.	Name	Initial value	Setting range	Description
<b>420</b> <b>B001</b>	<b>Command pulse scaling factor numerator (electronic gear numerator)</b>	1	1 to 32767	Set the electronic gear. <b>Pr.420</b> is the numerator and <b>Pr.421</b> is the denominator.
<b>421</b> <b>B002</b>	<b>Command pulse multiplication denominator (electronic gear denominator)</b>	1	1 to 32767	
<b>424</b> <b>B005</b>	<b>Position command acceleration/ deceleration time constant</b>	0 s	0 to 50 s	Use it when the rotation is not smooth because the electronic gear ratio is large (10 times or larger) and the rotation speed is slow.

### ◆ Gear ratio calculation (Pr.420, Pr.421)

The position resolution (travel distance per pulse  $\Delta\ell$  [mm]) is the travel distance per motor rotation  $\Delta s$  [mm] and the feedback pulse  $Pf$  [pulses/rev] of the detector.

$$\Delta\ell = \frac{\Delta s}{Pf}$$

$\Delta\ell$ : Travel distance per pulse [mm]  
 $\Delta s$ : Travel distance in one motor rotation [mm]  
 $pf$ : Number of feedback pulses [pulse/rev] (the number of pulses after the number encoder pulses is quadruplicated)

The travel distance in 1 command pulse can be separately specified with a parameter and so an integer can be set as the travel distance in 1 command pulse.

$$\Delta\ell = \frac{\Delta s}{Pf} \times \frac{\text{Pr.420}}{\text{Pr.421}}$$

The following formula shows the relationship between the motor speed and internal command pulse frequency.

$$f_o \times \frac{\text{Pr.420}}{\text{Pr.421}} = Pf \times \frac{N_o}{60}$$

$f_o$ : internal command pulse frequency [pulses/s]  
 $N_o$ : motor rotation speed [r/min]

**NOTE**

- Set the electronic gear ratio in the range of 1/50 to 20. Note that, if the setting value is too small, the speed command will also be too small; while if it is too large, the speed ripple will be too large.

Setting example 1	Setting example 2
<p>In a driving system whose ball screw pitch is PB = 10 (mm) and the reduction ratio is 1/n = 1, the electronic gear ratio is Δs = 10 (mm) when Δℓ = 0.01 (mm) and Pf = 4000 (pulses/rev) is set as the number of feedback pulses. Based on this, use the following formula:</p> $\Delta \ell = \frac{\Delta s}{Pf} \times \frac{\text{Pr.420}}{\text{Pr.421}}$ $\frac{\text{Pr.420}}{\text{Pr.421}} = \Delta \ell \times \frac{Pf}{\Delta s}$ $= 0.01 \times \frac{4000}{10} = \frac{4}{1}$ <p>Thus, set the parameters as follows: <b>Pr.420</b> = "4", <b>Pr.421</b> = "1".</p>	<p>Find the internal command pulse frequency for the rated motor speed of the dedicated motor. Where the command pulse ratio (<b>Pr.420/ Pr.421</b>) = 1, the number of encoder pulses = 2048 (pulses/rev), and the feedback pulse pf = 2048 × 4.</p> $f_o = 2048 \times 4 \times \frac{No}{60} \times \frac{\text{Pr.421}}{\text{Pr.420}}$ $= 204800$ <p>The internal command pulse is 204800 (pulses/s) in accordance with the above formula.</p>

### ■ Relationship between the position resolution and system accuracy

The system accuracy (the positioning accuracy of the machine) is the sum of electric deviation and mechanical deviation. Normally try to prevent the total deviation from being affected by the electronic deviation. Refer to the following relationship as a reference.

$$\Delta \ell < \left( \frac{1}{5} \text{ to } \frac{1}{10} \right) \times \Delta \varepsilon \quad \Delta \varepsilon: \text{positioning accuracy}$$

### ■ Motor stop characteristics

When running the motor by the parameter settings, the relationship between the internal command pulse frequency and the number of motor rotations is as shown in the figure on [page 299](#). Pulses as much as the motor speed delay are accumulated in the deviation counter. These pulses are called droop pulses (ε). The relationship between the command frequency (fo) and position loop gain (Kp: **Pr.422**) is shown in the following formula.

$$\varepsilon = \frac{f_o}{K_p} \text{ [pulse]} \quad \frac{204800}{25} \text{ [pulse]} \text{ (with the rated motor speed)}$$

The number of droop pulses (ε) is 8192 with the initial value Kp = 25 s<sup>-1</sup>.

Since the inverter has droop pulses during operation, a stop settling time (ts), which is the time between the zero command output and the motor stop, is required. Set the operation pattern taking into the account the stop setting time.

$$t_s = 3 \times \frac{1}{K_p} \text{ [s]}$$

The stop settling time (ts) is 0.12 second for the initial value Kp = 25 s<sup>-1</sup>.

The accuracy of positioning Δε is (5 to 10) × Δℓ = Δε [mm]

### ◆ Position command acceleration/deceleration time constant (Pr.424)

- If the electronic gear ratio is large (1:10 or larger) and the rotation speed is slow, the rotation is not smooth and the rotation shape becomes like a pulse.  
Set this option in such a case to smoothen the rotation.
- If the command pulse frequency varies rapidly when no acceleration time can be assigned to the command pulse, overshoot or excessive error alarms may occur. Set this option in such a case to set the acceleration/deceleration time.  
Normally it is set to 0.

#### ◀ Parameters referred to ▶▶

**Pr.422** Position control gain [page 328](#)

## 5.5.10 Position adjustment parameter settings



Pr.	Name	Initial value	Setting range	Description
426 B007	In-position width	100 pulses	0 to 32767 pulses	Set the number of droop pulses that triggers the In-position (Y36) signal.
427 B008	Excessive level error	40K	0 to 400K	Set the number of droop pulses that activates Excessive position fault (E.OD).
			9999	Function disabled
1294 B192	Position detection lower 4 digits	0	0 to 9999	Set the lower four digits of the position detection value.
1295 B193	Position detection upper 4 digits	0	0 to 9999	Set the upper four digits of the position detection value.
1296 B194	Position detection selection	0	0	The position is detected on both the plus and minus sides.
			1	The position is detected on the plus side only.
			2	The position is detected on the minus side only.
1297 B195	Position detection hysteresis width	0	0 to 32767	Set the hysteresis width for the detected position where the Position detection level (FP) signal turns ON.

5

### ◆ In-position width (Pr.426, Y36 signal)

- The Y36 signal is used as the in-position signal.
- If the number of droop pulses is equal to or smaller than the **Pr.426** setting value, the In-position (Y36) signal turns ON.
- To use the Y36 signal, set "36 (positive logic) or 136 (negative logic)" in any of **Pr.190 to Pr.196 (Output terminal function selection)** to assign the function.

### ◆ Excessive level error (Pr.427)

- If the number of droop pulses exceeds the **Pr.427** setting, a position error is detected, Excessive position fault (E.OD) is activated and the inverter output is shut off. Increase the error threshold level when a small value is set as the **Pr.422 Position control gain** setting value. Set a small value for early detection even when the load is heavy.
- If **Pr.427** = "9999", E.OD is not activated regardless of the amount of droop pulses.

### ◆ Position detection signal (Pr.1294 to Pr.1297, FP signal)

- The Position detection level (FP) signal is turned ON when the current position [before the electronic gear] exceeds the **Pr.1295** × 10000 + **Pr.1294** position detected. To use the FP signal, set "60 (positive logic) or 160 (negative logic)" in any of **Pr.190 to Pr.196 (Output terminal function selection)** to assign the function.
- Whether the position detection is determined on the plus side or minus side can be selected by **Pr.1296 Position detection selection**. When "0" is set, the position is detected on both the plus and minus sides. When "1" is set, the position is detected on the plus side only. When "2" is set, the position is detected on the minus side only.

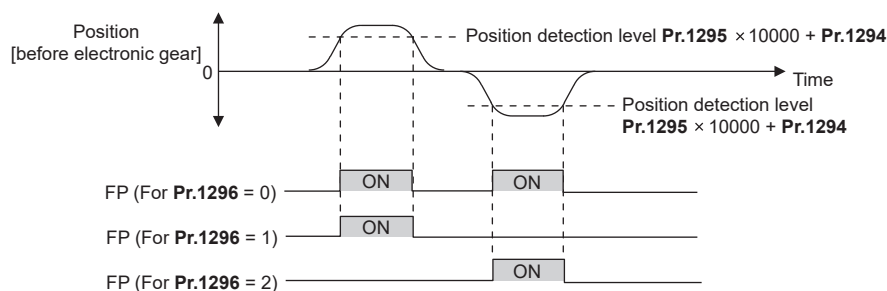

- When a current position varies, the Position detection level (FP) signal may repeat ON/OFF (chatter). Setting hysteresis to the detected position prevents chattering of the signal. Use **Pr.1297 Position detection hysteresis width** to set a hysteresis width.

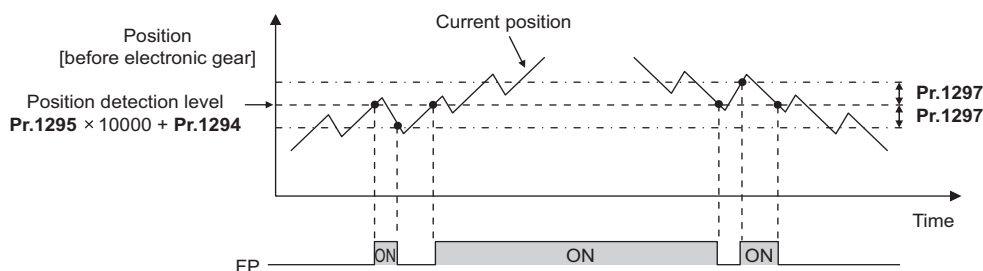

## 5.5.11 Position control gain adjustment

Vector **PM**

Easy gain tuning is provided as an easy tuning method. For details about easy gain tuning, refer to [page 254](#).

If easy gain tuning does not produce any effect, make fine adjustments by using the following parameters.

Set "0" to **Pr.819 Easy gain tuning selection** before setting the following parameters.

Pr.	Name	Initial value	Setting range	Description
422 B003	Position control gain	25 s <sup>-1</sup>	0 to 150 s <sup>-1</sup>	Set the gain for the position loop.
1298 B013	Second position control gain	25 s <sup>-1</sup>	0 to 150 s <sup>-1</sup>	Set the position loop gain for the second motor.
423 B004	Position feed forward gain	0%	0 to 100%	Function to cancel a delay caused by the droop pulses in the deviation counter.
425 B006	Position feed forward command filter	0 s	0 to 5 s	Input the primary delay filter for the feed forward command.
446 B012	Model position control gain	25 s <sup>-1</sup>	0 to 150 s <sup>-1</sup>	Set the gain for the model position controller.
828 G224	Model speed control gain	60%	0 to 1000%	Set the gain for the model speed controller.
877 G220	Speed feed forward control/ model adaptive speed control selection	0	0, 1 2	Perform position feed forward control. Model adaptive position control becomes valid.
880 C114	Load inertia ratio	7-fold	0 to 200-fold	Set the load inertia ratio for the motor.

### ◆ Position loop gain (Pr.422, Pr.1298)

- Make adjustment when any of such a phenomena as unusual vibration, noise and overcurrent of the motor/machine occurs.
- Increasing the setting improves traceability for the position command and also improves servo rigidity at a stop, but oppositely makes an overshoot and vibration more liable to occur.
- Normally set this parameter within the range about 5 to 50.

Movement/ condition	How to adjust Pr.422
Response is slow.	Increase the setting value. Increase the setting value by 3 s <sup>-1</sup> until immediately before an overshoot, stop-time vibration or other instable phenomenon does not occur, and set about 80 to 90% of that value.
Overshoot, stop-time vibration or other instable phenomenon occurs.	Lower the setting value. Lower the setting value by 3 s <sup>-1</sup> until immediately before an overshoot, stop-time vibration or other instable phenomenon does not occur, and set about 80 to 90% of that value.

### ◆ Position feed forward gain (Pr.423)

- This function is designed to cancel a delay caused by the droop pulses in the deviation counter. Set this parameter when a sufficient position response cannot be obtained after setting **Pr.422**.
- When a tracking delay for command pulses poses a problem, increase the setting gradually and use this parameter within the range where an overshoot or vibration will not occur.
- This function has no effects on servo rigidity at a stop.
- Normally set this parameter to 0.
- When setting **Pr.423**, set **Pr.877** = "0 or 1" to enable position feed forward control.

## ◆ Model adaptive position control (Pr.446)

- Set each response for position commands and for load and external disturbances individually.
- Set this parameter when a sufficient position response cannot be obtained after setting **Pr.422**.
- When setting **Pr.446**, set **Pr.877** = "2" to enable the model adaptive position control, **Pr.828 Model speed control gain** ≠ "0", and a load inertia ratio in **Pr.880 Load inertia ratio**.
- Set a small value in **Pr.446** first, and then increase the setting gradually and use this parameter within the range where an overshoot or vibration will not occur.

## 5.5.12 Troubleshooting in position control



Condition	Possible cause	Countermeasure
The motor does not rotate.	There is incorrect phase sequence between the motor wiring and encoder wiring.	Check the wiring. (Refer to <a href="#">page 87</a> .)
	The setting of <b>Pr.800 Control method selection</b> is not appropriate.	Check the <b>Pr.800</b> setting. (Refer to <a href="#">page 221</a> .)
	No LX signal or STF/STR signal is input.	Check if the signals are properly input.
	A command pulse or NP signal is not correctly input.	Check if the command pulse is properly input (check the accumulated value for command pulses in <b>Pr.430 Pulse monitor selection</b> ). Check the command pulse type in <b>Pr.428 Command pulse selection</b> . Check that the position pulse sign (NP) is assigned to an input terminal (inverter pulse input).
	The setting in <b>Pr.419 Position command source selection</b> is incorrect.	Check the <b>Pr.419 Position command source selection</b> .
	When simple position control by a point table ( <b>Pr.419</b> = "0") is used, the position feed length set by <b>Pr.465 to Pr.494</b> is not correct.	Check the position feed length in <b>Pr.465 to Pr.494</b> .
	The option to be used and parameter settings do not match.	Correctly set <b>Pr.862 Encoder option selection</b> according to the option to be used. (Refer to <a href="#">page 226</a> .)
The position is unfavorably shifted.	A command pulse is not correctly input.	Check the command pulse type in <b>Pr.428 Command pulse selection</b> . Check if the command pulse is properly input (check the accumulated value of command pulses in <b>Pr.430</b> ). Check that the position pulse sign (NP) is assigned to an input terminal (inverter pulse input).
	The command is affected by noise. Noise is superpositioned on the encoder feedback signals.	Set <b>Pr.72 PWM frequency selection</b> lower. Change the earthing (grounding) position of the shielded cable. Alternatively, do not connect it.
Hunting occurs in the motor or the machine.	Position loop gain is too high.	Set <b>Pr.422 Position control gain</b> lower.
	Speed loop gain is too high.	Perform easy gain tuning. Set <b>Pr.821 Speed control integral time 1</b> lower and <b>Pr.821 Speed control integral time 1</b> higher.
Machine movement is unstable.	Acceleration/deceleration time settings are affecting adversely.	Set <b>Pr.7 Acceleration time</b> , <b>Pr.8 Deceleration time</b> lower.

## ◆ Flowchart

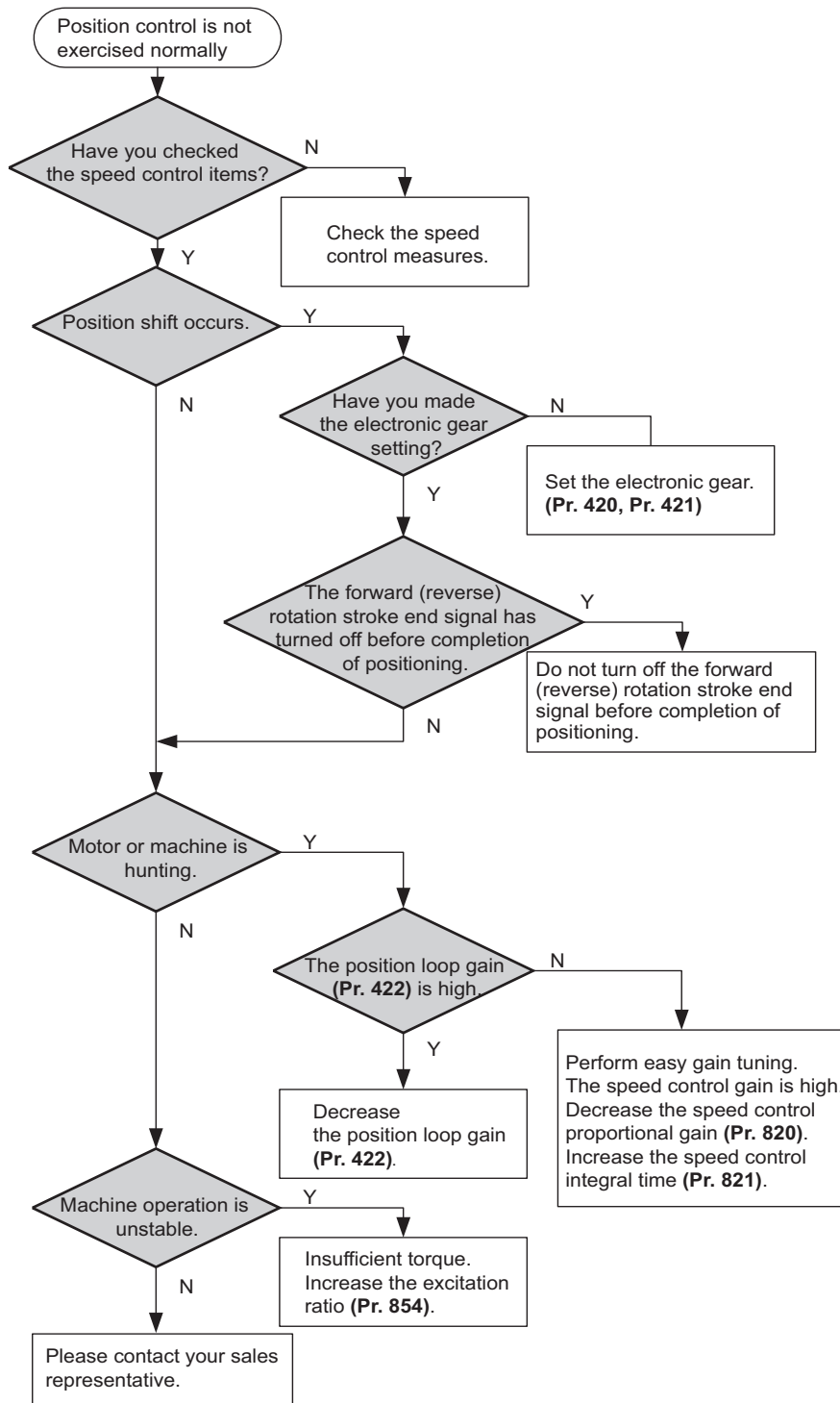

### NOTE

- The speed command of position control is related to speed control. (Refer to [page 235.](#))

« Parameters referred to »

Pr.7 Acceleration time [page 367](#)

Pr.8 Deceleration time [page 367](#)

Pr.72 PWM frequency selection [page 356](#)

Pr.800 Control method selection [page 221](#)

Pr.802 Pre-excitation selection [page 715](#)

Pr.819 Easy gain tuning selection [page 254](#)

Pr.820 Speed control P gain 1 [page 254](#)

Pr.821 Speed control integral time 1 [page 254](#)



# 5.6 Adjustment during Real sensorless vector control, Vector control, PM sensorless vector control

Purpose	Parameter to set			Refer to page
To stabilize speed and torque feedback signal	Speed detection filter, torque detection filter	P.G215, P.G216, P.G315, P.G316	Pr.823, Pr.827, Pr.833, Pr.837	332
To change excitation ratio	Excitation ratio	P.G217	Pr.854	332

## 5.6.1 Speed detection filter and torque detection filter

Sensorless
Vector
PM

Set time constant of primary delay filter for speed feedback signal and torque feedback signal. Speed loop response is reduced. Under ordinary circumstances, therefore, use the initial value as it is.

Pr.	Name	Initial value	Setting range	Description
823 G215*1	Speed detection filter 1	0.001 s	0	Without filter
			0.001 to 0.1 s	Set the time constant of primary delay filter for speed feedback signal.
827 G216	Torque detection filter 1	0 s	0	Without filter
			0.001 to 0.1 s	Set the time constant of primary delay filter torque feedback signal.
833 G315*1	Speed detection filter 2	9999	0 to 0.1 s	Second function of <b>Pr.823</b> (enabled when the RT signal is ON)
			9999	Same as <b>Pr.823</b> setting
837 G316	Torque detection filter 2	9999	0 to 0.1 s	Second function of <b>Pr.827</b> (enabled when the RT signal is ON)
			9999	Same as <b>Pr.827</b> setting

\*1 The setting is available when a Vector control compatible option is installed.

### ◆ Stabilizing speed detection (Pr.823, Pr.833)

- Speed loop response is reduced. Under ordinary circumstances, therefore, use the initial value as it is. If there is speed ripple due to high frequency disturbance, adjust until speed stabilizes by gradually raising the setting. Speed is oppositely destabilized if the setting value is too large.
- This setting is valid under Vector control only.

### ◆ Stabilizing torque detection (Pr.827, Pr.837)

- Current loop response is reduced. Under ordinary circumstances, therefore, use the initial value as it is. If there is torque ripple due to high frequency disturbance, adjust until speed stabilizes by gradually raising the setting. Speed is oppositely destabilized if the setting value is too large.

### ◆ Employing multiple primary delay filters

- Use **Pr.833** and **Pr.837** if changing filter according to application. **Pr.833**, **Pr.837** is enabled when the Second function selection (RT) signal is turned ON.

#### NOTE

- The RT signal is a second function selection signal which also enables other second functions. (Refer to [page 525.](#))
- The RT signal is assigned to the terminal RT in the initial status. Set "3" in one of **Pr.178** to **Pr.189** (**Input terminal function selection**) to assign the RT signal to another terminal.

## 5.6.2 Excitation ratio

Sensorless
Vector

The excitation ratio can be lowered to enhance efficiency for light loads. (Motor magnetic noise can be reduced.)

Pr.	Name	Initial value	Setting range	Description
854 G217	Excitation ratio	100%	0 to 100%	Set an excitation ratio when there is no load.

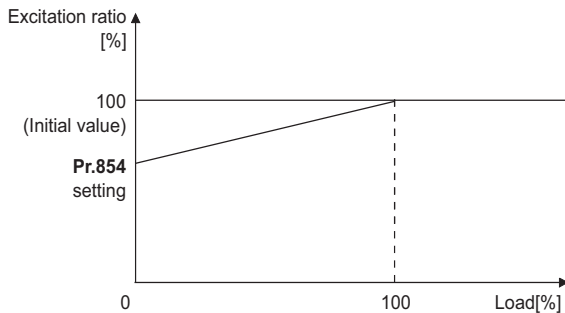

#### NOTE

- When excitation ratio is reduced, output torque startup is less responsive.
- The setting of Pr.854 is invalid if Pr.858 Terminal 4 function assignment or Pr.868 Terminal 1 function assignment is set to "1" (flux command according to terminal).

## 5.6.3 Gain adjustment of current controllers for the d axis and the q axis

### PM

The gain of the current controller can be adjusted.

Pr.	Name	Initial value	Setting range	Description
824 G213	Torque control P gain 1 (current loop proportional gain)	100%	0% to 500%	The proportional gain of the current controller is set.
825 G214	Torque control integral time 1 (current loop integral time)	5 ms	0 to 500 ms	The integral time of the current controller is set.

- Use Pr.824 Torque control P gain 1 (current loop proportional gain) to adjust the proportional gain of current controllers for the d axis and the q axis. The 100% gain is equivalent to 1000 rad/s. Setting this parameter higher improves the trackability for current command changes. It also reduces the current fluctuation caused by external disturbances.
- Use Pr.825 Torque control integral time 1 (current loop integral time) to set the integral time of current controllers for the d axis and the q axis. If the setting value is small, it produces current fluctuation against external disturbances, decreasing time until it returns to original current value.

#### NOTE

- Pr.834 Torque control P gain 2 (current loop proportional gain) and Pr.835 Torque control integral time 2 (current loop integral time) are valid when the RT signal turns ON.  
In this case, replace them for Pr.824 and Pr.825 in the description above.

## 5.7 (E) Environment setting parameters

Purpose	Parameter to set			Refer to page
To set the time	Real time clock function	P.E020 to P.E022	Pr.1006 to Pr.1008	334
To set a limit for the reset function. To shut off output if the operation panel disconnects. To force deceleration to a stop on the operation panel.	Reset selection/ disconnected PU detection/PU stop selection/reset limit	P.E100 to P.E102, P.E107	Pr.75	336
To select the display language of the parameter unit	PU display language selection	P.E103	Pr.145	339
To control the buzzer of the parameter unit and operation panel	PU buzzer control	P.E104	Pr.990	340
To adjust the LCD contrast of the parameter unit	PU contrast adjustment	P.E105	Pr.991	340
To turn OFF the operation panel when not using it for a certain period of time	Display-off setting	P.E106	Pr.1048	340
To switch the monitor display of the operation panel to the PID set point setting screen by simply turning the setting dial	Direct setting	P.E108	Pr.1000	340
To use the USB memory	USB host reset	P.E110	Pr.1049	341
To use the setting dial of the operation panel like a potentiometer to set the frequency. To disable the operation panel.	Operation panel operation selection	P.E200	Pr.161	341
To change the frequency change increments which changes when using the setting dial of the operation panel	Frequency change increment amount setting	P.E201	Pr.295	342
To use the regeneration unit to increase the motor braking torque	Regenerative brake selection	P.E300, P.G107	Pr.30, Pr.70	724
To change the overload current rating specification	Multiple rating setting	P.E301	Pr.570	343
To input a voltage between 480 V and 500 V	Input voltage mode selection	P.E302	Pr.977	345
To prevent parameter rewriting	Parameter write disable selection	P.E400	Pr.77	345
To restrict parameters with a password	Password	P.E410, P.E411	Pr.296, Pr.297	348
To use parameters freely	Free parameter	P.E420, P.E421	Pr.888, Pr.889	350
To change parameter settings for an IPM motor as a batch	IPM parameter initialization	P.E430	Pr.998	231
To set multiple parameters by batch	Automatic parameter setting	P.E431	Pr.999	350
To display the required parameters	Applicable parameter display and user group function	P.E440 to P.E443	Pr.160, Pr.172 to Pr.174	354
To release the Parameter copy warning (CP)	Parameter copy alarm release	P.E490	Pr.989	744
To reduce the motor noise and EMI	PWM carrier frequency changing	P.E600 to P.E602	Pr.72, Pr.240, Pr.260	356
To understand the maintenance time of inverter parts and peripheral devices	Inverter parts life display	P.E700 to P.E705	Pr.255 to Pr.259, Pr.506	359
	Maintenance output function	P.E710 to P.E715	Pr.503 to Pr.504, Pr.686 to Pr.689	363
	Current average monitor	P.E720 to P.E722	Pr.555 to Pr.557	363

### 5.7.1 Real time clock function

The time can be set. The time can only be updated while the inverter power is ON.

The real time clock function is enabled using an optional LCD operation panel (FR-LU08).

Pr.	Name	Initial value	Setting range	Description
1006 E020	Clock (year)	2000 (year)	2000 to 2099	Set the year.
1007 E021	Clock (month, day)	101 (January 1)	101 to 131, 201 to 228, (229), 301 to 331, 401 to 430, 501 to 531, 601 to 630, 701 to 731, 801 to 831, 901 to 930, 1001 to 1031, 1101 to 1130, 1201 to 1231	Set the month and day. 1000's and 100's digits: Month (1 (January) to 12 (December)). 10's and 1's digits: Day (1 to the last day of the month (28, 29, 30, or 31)). For December 31, set "1231".
1008 E022	Clock (hour, minute)	0 (00:00)	0 to 59, 100 to 159, 200 to 259, 300 to 359, 400 to 459, 500 to 559, 600 to 659, 700 to 759, 800 to 859, 900 to 959, 1000 to 1059, 1100 to 1159, 1200 to 1259, 1300 to 1359, 1400 to 1459, 1500 to 1559, 1600 to 1659, 1700 to 1759, 1800 to 1859, 1900 to 1959, 2000 to 2059, 2100 to 2159, 2200 to 2259, 2300 to 2359	Set the hour and minute using the 24-hour clock. 1000's and 100's digits: 0 to 23 hours, 10's and 1's digits: 0 to 59 minutes. For 23:59, set "2359".

### ◆ Simple clock function

- When the current year, month, day, hour and minute are set in the parameters above, the inverter internal clock starts ticking. The set date and time can be checked by reading the parameters.

#### NOTE

- The time data of the internal clock is saved in the inverter's EEPROM every 10 minutes.
- The clock does not run while the control circuit power is OFF. The clock needs to be set every time after turning ON the inverter power. Prepare separate power supply, such as an external 24 V power supply, to supply power continuously to the control circuit for the simple clock function.
- However, if the power to the main circuit of the inverter is turned ON with the control circuit power already ON, the clock data is reset to the data stored in EEPROM because the Inverter reset is performed whenever the power is supplied to the main circuit of the inverter in the initial setting. To prevent the clock from resetting, set **Pr.30 Regenerative function selection**. (Refer to [page 724](#).)
- The set time is used for functions such as the Fault history.

### ◆ Real time clock function

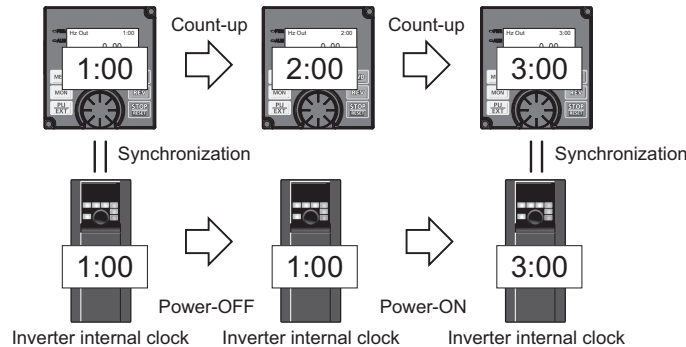

- When the FR-LU08 is connected to the inverter, the internal clock of the inverter can be synchronized with the clock in the FR-LU08 (Real time clock function). The FR-LU08 with battery (CR1216) backup can keep its clock function running even if the main power of the inverter is turned OFF. (The inverter internal clock stops running when the inverter power is turned OFF.)
- To adjust the clock in the FR-LU08, set **Pr.1006 to Pr.1008** on the FR-LU08.

#### NOTE

- Time synchronization between the inverter internal clock and the clock in the FR-LU08 is performed every one minute.
- If the FR-LU08 clock is reset due to dead battery for example, the data in the inverter internal clock is used.

## 5.7.2 Reset selection / disconnected PU detection / PU stop selection

The acceptance of reset command, the inverter operation in the event of detection of the PU (operation panel / parameter unit) disconnected, and the acceptance of stop command from the PU (PU stop function) can be selected using Pr.E100 (Reset selection), Pr.E101 (Disconnected PU detection), and Pr.E102 (PU stop selection), respectively, or using Pr.75 alone.

Pr.	Name	Initial value	Setting range	Description
75	Reset selection/ disconnected PU detection/PU stop selection	14	0 to 3, 14 to 17, 1000 to 1003, 1014 to 1017 <sup>*1</sup>	In the initial setting, the reset command input is always enabled, the inverter operation continues even when PU is disconnected, and the operation can be stopped on the PU.
			0 to 3, 14 to 17, 100 to 103, 114 to 117, 1000 to 1003, 1014 to 1017, 1100 to 1103, 1114 to 1117 <sup>*2</sup>	
E100	Reset selection	0	0	Reset input is always enabled.
			1	Reset input is enabled only when the protective function is activated.
			2	Reset input is enabled only when the start signal is OFF.
			3	Reset input is enabled when the protective function is activated and the start signal is OFF.
E101	Disconnected PU detection	0	0	Operation continues even when the PU is disconnected.
			1	The inverter output is shut off when the PU is disconnected.
E102	PU stop selection	1	0	The inverter decelerates to a stop when the STOP key on the PU is pressed in PU operation mode. (The PU stop function is disabled.)
			1	The inverter decelerates to a stop when the STOP key on the PU is pressed in any operation mode of the PU, external, or Network. (The PU stop function is enabled.)
E107	Reset limit	0	0	Reset limit is disabled.
			1 <sup>*2</sup>	Reset limit is enabled.

The parameters above do not return to their initial values even if Parameter clear/All parameter clear is executed.

\*1 The setting range of the FR-A820-03160(55K) or lower and the FR-A840-01800(55K) or lower

\*2 The setting range of the FR-A820-03800(75K) or higher and the FR-A840-02160(75K) or higher

Pr.75 setting	Reset input	Operation after PU disconnection is detected	PU stop function	Reset limit function
0	Always enabled.	Operation continues.	Disabled	Disabled
1	When the protective function is activated.	Operation continues.	Disabled	Disabled
2	Always enabled.	Inverter output shutoff	Disabled	Disabled
3	When the protective function is activated.	Inverter output shutoff	Disabled	Disabled
14 (initial value)	Always enabled.	Operation continues.	Enabled	Disabled
15	When the protective function is activated.	Operation continues.	Enabled	Disabled
16	Always enabled.	Inverter output shutoff	Enabled	Disabled
17	When the protective function is activated.	Inverter output shutoff	Enabled	Disabled
100	Always enabled.	Operation continues.	Disabled	Enabled <sup>*3</sup>
101	When the protective function is activated.	Operation continues.	Disabled	Enabled <sup>*3</sup>
102	Always enabled.	Inverter output shutoff	Disabled	Enabled <sup>*3</sup>
103	When the protective function is activated.	Inverter output shutoff	Disabled	Enabled <sup>*3</sup>
114	Always enabled.	Operation continues.	Enabled	Disabled
115	When the protective function is activated.	Operation continues.	Enabled	Disabled
116	Always enabled.	Inverter output shutoff	Enabled	Disabled
117	When the protective function is activated.	Inverter output shutoff	Enabled	Disabled
1000	When the start signal is OFF.	Operation continues.	Disabled	Disabled
1001	When the protective function is activated and the start signal is OFF.	Operation continues.	Disabled	Disabled
1002	When the start signal is OFF.	Inverter output shutoff	Disabled	Disabled
1003	When the protective function is activated and the start signal is OFF.	Inverter output shutoff	Disabled	Disabled
1014	When the start signal is OFF.	Operation continues.	Enabled	Disabled
1015	When the protective function is activated and the start signal is OFF.	Operation continues.	Enabled	Disabled
1016	When the start signal is OFF.	Inverter output shutoff	Enabled	Disabled
1017	When the protective function is activated and the start signal is OFF.	Inverter output shutoff	Enabled	Disabled
1100	When the start signal is OFF.	Operation continues.	Disabled	Enabled <sup>*3</sup>
1101	When the protective function is activated and the start signal is OFF.	Operation continues.	Disabled	Enabled <sup>*3</sup>
1102	When the start signal is OFF.	Inverter output shutoff	Disabled	Enabled <sup>*3</sup>
1103	When the protective function is activated and the start signal is OFF.	Inverter output shutoff	Disabled	Enabled <sup>*3</sup>
1114	When the start signal is OFF.	Operation continues.	Enabled	Enabled <sup>*3</sup>
1115	When the protective function is activated and the start signal is OFF.	Operation continues.	Enabled	Enabled <sup>*3</sup>
1116	When the start signal is OFF.	Inverter output shutoff	Enabled	Enabled <sup>*3</sup>
1117	When the protective function is activated and the start signal is OFF.	Inverter output shutoff	Enabled	Enabled <sup>*3</sup>

\*3 The setting is available for the FR-A820-03800(75K) or higher and FR-A840-02160(75K) or higher.

## ◆ Reset selection (P.E100)

- While **P.E100** = "1", or **Pr.75** = "1, 3, 15, 17, 101, 103, 115, or 117", the reset command input is enabled (using the RES signal or through communication) only when the protective function is activated.
- While **P.E100** = "2" or **Pr.75** = "1000, 1002, 1014, 1016, 1100, 1102, 1114, or 1116", the reset command input is enabled (using the RES signal or through communication) only when the start signal is OFF.
- While **P.E100** = "3" or **Pr.75** = "1001, 1003, 1015, 1017, 1101, 1103, 1115, or 1117", the reset command input is enabled (using the RES signal or through communication) only when the protective function is activated with the start signal OFF.

**NOTE**

- When the RES signal is input during operation, the motor coasts since the inverter being reset shuts off the output. Also, the cumulative values of electronic thermal O/L relay and regenerative brake duty are cleared.
- When "reset input always enabled" is selected, the reset key on the PU is enabled only when the protective function is activated.
- The following table shows applicable start commands. (When both the STF and STR signals are ON, the start signal status is OFF.)

Start signal input interface	Applicable start signal
External terminal	X13, X22, LX, X28, JOGF, JOGR, STF, or STR
PU	Forward/reverse rotation command given by pressing the FWD/REV key
Communication	X13, X22, LX, X28, STF, or STR

**◆ Disconnected PU detection (P.E101)**



- When the inverter detects that the PU (FR-DU08/FR-PU07) is disconnected from the inverter for 1 second or more while **P.E101** or **Pr.75** is set to shut off the inverter output upon disconnection of the PU, the PU disconnection ("E.PUE") indication is displayed and the inverter output is shut off.

**NOTE**

- When the PU has been disconnected before power-ON, the output is not shut off.
- To restart the inverter operation, confirm that the PU is connected before reset.
- When the inverter detects that the PU is disconnected during PU JOG operation while **P.E101** or **Pr.75** is set to continue the inverter operation even when the PU is disconnected, the inverter decelerates the motor to a stop.
- During RS-485 communication operation via the PU connector, the Reset selection function and the PU stop selection function are enabled but the Disconnected PU detection function is disabled. (The communication is checked according to **Pr.122 PU communication check time interval**.)

**◆ PU stop selection (P.E102)**

- When the PU stop function is enabled, the motor can be decelerated to a stop by pressing  on the PU in either PU, External, or Network operation mode.
- The table below describes situations in which the PU stop function is activated. The indication "PS" is displayed on the PU, and the operation cannot be restarted while the indication remains on. However, the Fault signal is not output.

Operation mode	Operation
External External/PU combined 1 Network	 on the PU is pressed during operation.
PU operation mode	 on the PU is pressed while the inverter is operated by a command source other than the PU. (The command interface/source is selected by setting <b>Pr.551 PU mode operation command source selection</b> .)

**◆ How to restart the inverter which has been stopped in the External operation mode by using  on the PU ("PS" (PU stop) warning reset method)**

- For the operation panel (FR-DU08)
  1. After completion of deceleration stop, turn OFF the STF and STR signals.
  2. Press  three times ("PS" is cleared) when **Pr.79 Operation mode selection** = "0 (initial value) or 6".  
When **Pr.79** = "2, 3, or 7", the PU stop warning can be cleared with one keystroke.
- For the parameter unit (FR-PU07)

1. After completion of deceleration stop, turn OFF the STF or STR signal.
2. Press  ("PS" is cleared).

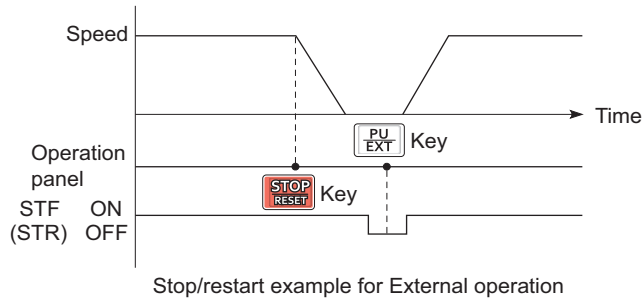

- The inverter can be restarted by performing the reset operation (by turning OFF and ON the power or inputting the RES signal).

**NOTE**

- Even when **Pr.250 Stop selection** ≠ "9999" is set and coasting stop is selected, using the PU stop function in the External operation mode does not provide coasting stop but deceleration stop.

**◆ Reset limit (P.E107)**

- Setting **P.E107** = "1" or **Pr.75** = any of "100 to 103, 114 to 117, 1100 to 1103, or 1114 to 1117" will make the inverter to refuse any reset operation (RES signal input, etc.) for 3 minutes after the first activation of an electronic thermal O/L relay or protective function (E.THM, E.THT, E.OC[]).
- The reset limit function is available with the FR-A820-03800(75K) or higher and the FR-A840-02160(75K) or higher.

**NOTE**

- Resetting the inverter power (turning OFF the control power) clears the accumulated thermal value.
- When the retry function is set enabled (**Pr.67 Number of retries at fault occurrence** ≠ "0"), the reset limit function is disabled.

**⚠ CAUTION**

- Do not perform a reset while a start signal is being input. Doing so will cause a sudden start of the motor, which is dangerous.

« Parameters referred to »  
 Pr.67 Number of retries at fault occurrence [page 426](#)  
 Pr.79 Operation mode selection [page 389](#)  
 Pr.250 Stop selection [page 722](#)  
 Pr.551 PU mode operation command source selection [page 400](#)

### 5.7.3 PU display language selection

You can switch the display language of the parameter unit (FR-PU07) to another.

Pr.	Name	Initial value	Setting range	Description
145 E103	PU display language selection	—	0	Japanese
			1	English
			2	German
			3	French
			4	Spanish
			5	Italian
			6	Swedish
			7	Finnish



## 5.7.4 Buzzer control

The PU (operation panel or parameter unit) key sound and buzzer can be turned ON/OFF.

Pr.	Name	Initial value	Setting range	Description
990 E104	PU buzzer control	1	0	Turns the key sound and buzzer OFF.
			1	Turns the key sound and buzzer ON.

### NOTE

- When the buzzer is set to ON, a warning sound will be audible when a fault occurs.

## 5.7.5 PU contrast adjustment

Contrast of the LCD display on the LCD operation panel (FR-LU08) or the parameter unit (FR-PU07) can be adjusted. Decreasing the setting value lowers the contrast.

Pr.	Name	Initial value	Setting range	Description
991 E105	PU contrast adjustment	58	0 to 63	0: Low → 63: High

This parameter can be selected from among simple mode parameters only when the LCD operation panel (FR-LU08) or the parameter unit (FR-PU07) is connected to the inverter.

## 5.7.6 Display-off setting

The LED display of the operation panel (FR-DU08) can be turned OFF when the operation panel has not been used for a certain period of time.

Pr.	Name	Initial value	Setting range	Description
1048 E106	Display-off waiting time	0	0	Display-off setting is disabled.
			1 to 60 (minutes)	Set time until the LED of the operation panel is turned OFF.

- When the operation panel has not been operated for the time set in **Pr.1048**, the display-off setting is activated and the LED display turns OFF.
- In the display-off state, the [MON] indicator blinks slowly.
- The time interval counting for display-off is reset at removal/reinstallation of the operation panel, power-ON/OFF of the inverter, or the Inverter reset.
- The triggers for display-on are as follows:
  - Operation of the operation panel,
  - Occurrence of a warning, alarm, or fault,
  - Removal/reinstallation of the operation panel, power-ON/OFF of the inverter, or the Inverter reset,
  - Connection/disconnection at the USB A connector.

### NOTE



- The [P.RUN] indicator is ON even if the operation panel is in the display-off state (while the PLC function is enabled).

## 5.7.7 Direct setting

The PID set point setting screen (direct setting screen) can be displayed first on the LCD operation panel (FR-LU08) according to the parameter setting.

Pr.	Name	Initial value	Setting range	Description
1000 E108	Direct setting selection	0	0	Displays the Frequency setting screen.
			1	Displays the direct setting screen (for set point setting).
			2	Displays the direct setting screen (for set point setting) and the frequency setting screen.

- This function is useful for setting the PID set point on the LCD operation panel.

- The monitor display can be switched from the main monitor screen to the set point setting screen for the PID action simply by turning , according to the setting of **Pr.1000 Direct setting selection**. On each setting screen, turn  to input a setting value, and press  to confirm the setting.

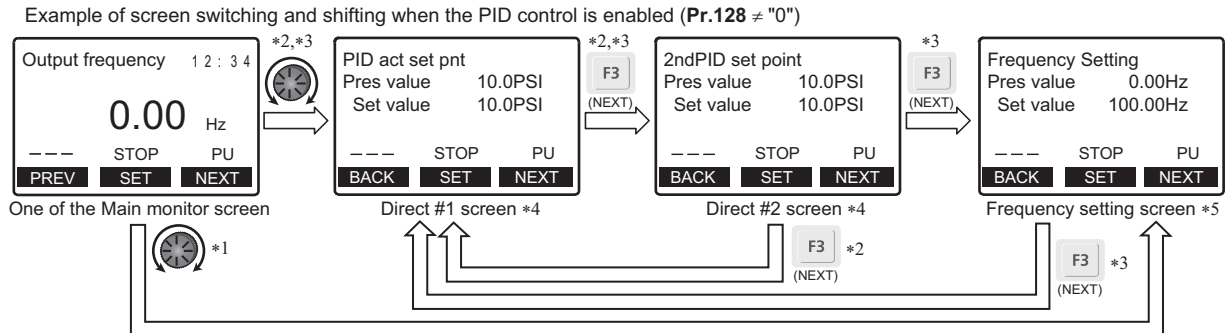

- \*1 When **Pr.1000** = "0"
- \*2 When **Pr.1000** = "1"
- \*3 When **Pr.1000** = "2"
- \*4 Not displayed when PID control is disabled (**Pr.128** = "0").
- \*5 Indication of "NEXT" is not displayed when **Pr.1000** = "0".

- To switch back the monitor display from the Extended direct screen or the Frequency setting screen to the Main monitor screen, press .

### Parameters referred to

Pr.128 PID action selection [page 601](#)

## 5.7.8 Resetting USB host errors

When a USB device is connected to the USB connector (connector A), the USB host error can be canceled without performing the Inverter reset.

Pr.	Name	Initial value	Setting range	Description
1049 E110	USB host reset	0	0	Read only
			1	Resets the USB host.

- Parameter copy (refer to [page 744](#)) or the trace function (refer to [page 649](#)) is available when a USB device (such as a USB memory) is connected to the USB connector (connector A).
- When a device such as a USB charger is connected to the USB connector and an excessive current (500 mA or higher) flows, USB host error "UF" (UF warning) is displayed on the operation panel.
- When the UF warning appears, the USB error can be canceled by removing the USB device and setting **Pr.1049** = "1". (The UF warning can also be canceled by resetting the inverter power or resetting with the RES signal.)

## 5.7.9 Easy frequency setting (Volume-knob-like setting) and key lock function selection

The frequency can be easily set with the setting dial on the operation panel (FR-DU08) like a volume knob.

The key operation of the operation panel can be disabled.

Pr.	Name	Initial value	Setting range	Description
161 E200	Frequency setting/key lock operation selection	0	0	Normal frequency setting
			1	Easy frequency setting (Volume-knob-like setting)
			10	Normal frequency setting
			11	Easy frequency setting (Volume-knob-like setting)
			Key lock function disabled.	
			Key lock function enabled.	



## ◆ Setting the frequency by turning the setting dial like a volume knob

- The frequency can be set by simply turning the setting dial on the operation panel (FR-DU08) during operation (Volume-knob-like setting).  needs not to be pressed. (For details on the operation method, refer to [page 150.](#))

### NOTE

- If the display changes from blinking "60.00" to "0.00", the setting value of **Pr.161** may not be "1".
- The newly-set frequency is saved as the set frequency in EEPROM after 10 seconds.
- When setting the frequency by turning the setting dial, the frequency goes up to the set value of **Pr.1 Maximum frequency**. Be aware of what frequency **Pr.1** is set to, and adjust the setting of **Pr.1** according to the application.

## ◆ Disabling the setting dial and keys on the operation panel (by holding down the MODE key for 2 seconds)

- The setting dial and keys on the operation panel (FR-DU08) can be disabled to prevent parameter changes, unexpected starts or frequency changes.
- Set **Pr.161** to "10 or 11" and then press  for 2 seconds to disable setting dial and keys.
- When setting dial and keys are disabled, "HOLD" appears on the operation panel. If setting dial or key operation is attempted while dial and keys are disabled, "HOLD" appears. (After no setting dial or key operation for 2 seconds, the display returns to the monitoring screen.)
- To enable the setting dial and keys again, press  for 2 seconds.

### NOTE

- Even if setting dial and keys are disabled, the monitor indicator and  are enabled.
- The PU stop warning cannot be reset by using keys while the key lock function is enabled.

### Parameters referred to

Pr.1 Maximum frequency  [page 428](#)

## 5.7.10 Frequency change increment amount setting

When setting the set frequency with the setting dial of the operation panel (FR-DU08), the frequency changes in 0.01 Hz increments in the initial status. Setting this parameter to increase the frequency increment amount that changes when the setting dial is rotated can improve usability.

Pr.	Name	Initial value	Setting range	Description
295 E201	Frequency change increment amount setting	0	0	Function disabled
			0.01	The minimum change width when the set frequency is changed with the setting dial can be set.
			0.10	
			1.00	
			10.00	

## ◆ Basic operation

- When **Pr.295** ≠ "0", the minimum increment when the set frequency is changed with the setting dial can be set. For example, when **Pr.295** = 1.00 Hz, one click (one dial gauge) of the setting dial changes the frequency in increments of 1.00 Hz, such as 1.00 Hz → 2.00 Hz → 3.00 Hz.

When **Pr.295**="1"

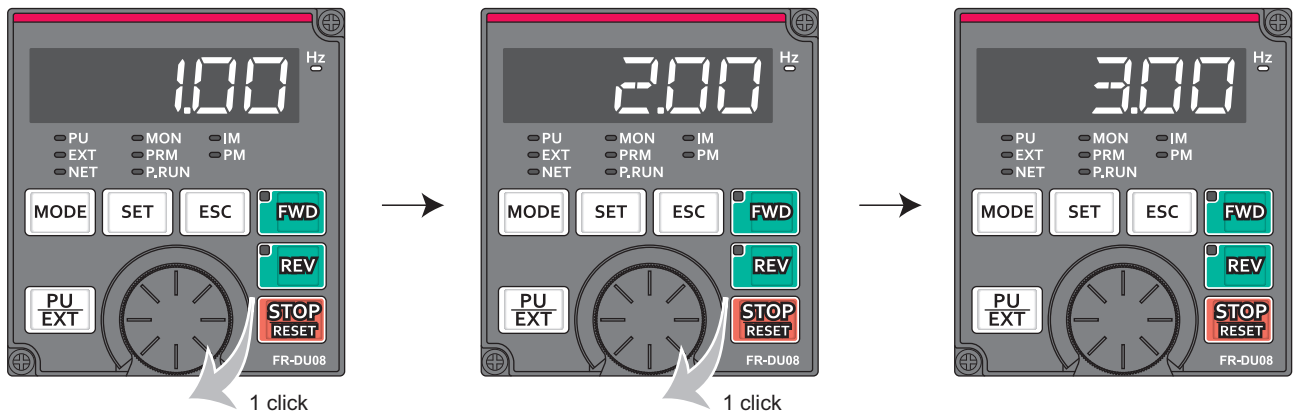

5

### NOTE

- When machine speed display is selected in **Pr.37 Speed display**, the minimum increments of change are determined by **Pr.295** as well. Note that the setting value may differ as speed setting changes the set machine speed and converts it to the speed display again.
- For **Pr.295**, the increments are not displayed.
- The **Pr.295** setting is enabled only for the changes to the set frequency. It does not apply to the settings of other parameters related to frequency.
- When 10 is set, the frequency setting changes in 10 Hz increments. Be cautious of excessive speed (in potentiometer mode).

### Parameters referred to

Pr.37 Speed display [page 444](#)

## 5.7.11 Multiple rating setting

Four rating types of different rated current and permissible load can be selected. The optimal inverter rating can be chosen in accordance with the application, enabling equipment size to be reduced.

Pr.	Name	Initial value	Setting range	Description (overload current rating, surrounding air temperature)
570 E301	Multiple rating setting	2	0*1	SLD rating. 110% for 60 seconds, 120% for 3 seconds (inverse-time characteristics) at surrounding air temperature of 40°C.
			1	LD rating. 120% for 60 seconds, 150% for 3 seconds (inverse-time characteristics) at surrounding air temperature of 50°C.
			2	ND rating. 150% for 60 seconds, 200% for 3 seconds (inverse-time characteristics) at surrounding air temperature of 50°C.
			3*1	HD rating. 200% for 60 seconds, 250% for 3 seconds (inverse-time characteristics) at surrounding air temperature of 50°C.

\*1 Not compatible with the IP55 compatible model.

## ◆ Changing the parameter initial values and setting ranges

- When inverter reset and all parameter clear are performed after setting **Pr.570**, the parameter initial values are changed according to each rating, as shown below.

Pr.	Name	Pr.570 setting				Refer to page
		0	1	2 (initial value)	3	
0	Torque boost	*1	*1	*1	*1	706
7	Acceleration time	*1	*1	*1	*1	367
8	Deceleration time	*1	*1	*1	*1	367
9	Electronic thermal O/L relay	SLD rated current <sup>*2</sup>	LD rated current <sup>*2</sup>	ND rated current <sup>*2*3</sup>	HD rated current <sup>*2*3</sup>	415
12	DC injection brake operation voltage	*1	*1	*1	*1	715
22	Stall prevention operation level	110%	120%	150%	200%	245, 431
48	Second stall prevention operation level	110%	120%	150%	200%	431
56	Current monitoring reference	SLD rated current <sup>*2</sup>	LD rated current <sup>*2</sup>	ND rated current <sup>*2</sup>	HD rated current <sup>*2</sup>	457
114	Third stall prevention operation level	110%	120%	150%	200%	431
148	Stall prevention level at 0 V input	110%	120%	150%	200%	431
149	Stall prevention level at 10 V input	120%	150%	200%	250%	431
150	Output current detection level	110%	120%	150%	200%	487
165	Stall prevention operation level for restart	110%	120%	150%	200%	628
557	Current average value monitor signal output reference current	SLD rated current <sup>*2</sup>	LD rated current <sup>*2</sup>	ND rated current <sup>*2</sup>	HD rated current <sup>*2</sup>	363
874	OLT level setting	110%	120%	150%	200%	245
893	Energy saving monitor reference (motor capacity)	SLD rated motor capacity <sup>*2</sup>	LD rated motor capacity <sup>*2</sup>	ND rated motor capacity <sup>*2</sup>	HD rated motor capacity <sup>*2</sup>	467

\*1 Initial values differ depending on the rating as follows.

Pr.	Pr.570 setting	200 V class FR-A820-[]																	
		00046 (0.4K)	00077 (0.75K)	00105 (1.5K)	00167 (2.2K)	00250 (3.7K)	00340 (5.5K)	00490 (7.5K)	00630 (11K)	00770 (15K)	00930 (18.5K)	01250 (22K)	01540 (30K)	01870 (37K)	02330 (45K)	03160 (55K)	03800 (75K)	04750 (90K)	
		400 V class: FR-A840-[]																	
		00023 (0.4K)	00038 (0.75K)	00052 (1.5K)	00083 (2.2K)	00126 (3.7K)	00170 (5.5K)	00250 (7.5K)	00310 (11K)	00380 (15K)	00470 (18.5K)	00620 (22K)	00770 (30K)	00930 (37K)	01160 (45K)	01800 (55K)	02160 (75K)	02600 (90K) or higher	
0 (%)	0, 1	6	4	4	4	3	3	2	2	2	2	2	2	2	1.5	1.5	1	1	1
	2	6	6	4	4	4	3	3	2	2	2	2	2	2	2	2	1	1	1
	3	6	6	6	4	4	4	3	3	2	2	2	2	2	2	2	2	2	1
7 (s)	0, 1	5	5	5	5	5	5	15	15	15	15	15	15	15	15	15	15	15	15
	2	5	5	5	5	5	5	5	15	15	15	15	15	15	15	15	15	15	15
	3	5	5	5	5	5	5	5	5	15	15	15	15	15	15	15	15	15	15
8 (s)	0, 1	10	10	10	10	10	10	30	30	30	30	30	30	30	30	30	30	30	30
	2	5	5	5	5	5	5	5	15	15	15	15	15	15	15	15	15	15	15
	3	5	5	5	5	5	5	5	5	15	15	15	15	15	15	15	15	15	15
12 (%)	0, 1	4	4	4	4	4	4	2	2	2	2	2	2	2	2	2	1	1	1
	2	4	4	4	4	4	4	4	2	2	2	2	2	2	2	2	2	1	1
	3	4	4	4	4	4	4	4	4	2	2	2	2	2	2	2	2	2	1

\*2 The rated current and motor capacity differ depending on the inverter capacity. Refer to the inverter rated specifications (page 826).

\*3 The initial value for the FR-A820-00077(0.75K) or lower and the FR-A840-00038(0.75K) or lower is set to the 85% of the inverter rated current.

- Setting **Pr.292 Automatic acceleration/deceleration** = "5 or 6 (lift mode)" changes the stall prevention operation level as shown below.

Pr.	setting	Pr.570 setting				Refer to page
		0	1	2 (initial value)	3	
292	5	110%	120%	150%	200%	384
	6	115%	140%	180%	230%	

**NOTE**

- When **Pr.570** = "0" (SLD rating), carrier frequency automatic reduction is enabled regardless of the setting in **Pr.260**.
- To use the FR-A820-03160(55K) and the FR-A840-01800(55K) in the LD and SLD ratings, a DC reactor, which is available as an option, corresponding to the applied motor is required.
- Setting the LD or SLD rating to the FR-A820-03160(55K) and the FR-A840-01800(55K) changes their parameter setting increments and setting ranges in the same way as for the FR-A820-03800(75K) and the FR-A840-02160(75K) or higher. In an example of **Pr.9**, the setting increment changes from "0.01 A" to "0.1 A" and the setting range changes from "0 to 500 A" to "0 to 3600 A". For the setting of each parameter, refer to the parameter list (on [page 166](#)).

«Parameters referred to»

**Pr.260** PWM frequency automatic switchover [page 356](#)

## 5.7.12 Using the power supply exceeding 480 VAC

To input a voltage between 480 VAC and 500 VAC to the 400 V class inverter, change the voltage protection level.

Pr.	Name	Initial value	Setting range	Description
<b>977</b> <b>E302</b>	<b>Input voltage mode selection</b>	0	0	400 V class voltage protection level
			1	500 V class voltage protection level
			2	For manufacturer setting. Do not set.

- To use a voltage between 480 VAC and 500 VAC, set **Pr.977 Input voltage mode selection** = "1". The setting is applied after a reset.
- Setting **Pr.977** = "1" changes the voltage protection level to the one for the 500 V class.
- The increased magnetic excitation deceleration operation level is 740 V. Use **Pr.660 Increased magnetic excitation deceleration operation selection** to select the increased magnetic excitation deceleration.)

**NOTE**

- To check availability of stand-alone options when the input voltage is between 480 and 500 VAC, refer to the Instruction Manual or catalog of each option for details on the ratings.
- Changing the **Pr.977** setting does not affect the voltage level to activate the regenerative overvoltage trip (E.OV1 to E.OV3).
- Changing the **Pr.977** setting does not affect the voltage level set in **Pr.883 Regeneration avoidance operation level**.
- The setting of **Pr.977** is invalid for the 200 V class inverter.

«Parameters referred to»

**Pr.660** Increased magnetic excitation deceleration operation selection [page 735](#)

## 5.7.13 Parameter write selection

Whether to enable the writing to various parameters or not can be selected. Use this function to prevent parameter values from being rewritten by misoperation.

Pr.	Name	Initial value	Setting range	Description
<b>77</b> <b>E400</b>	<b>Parameter write selection</b>	0	0	Parameter write is enabled only during stop.
			1	Parameter writing is disabled.
			2	Parameter writing is enabled in any operation mode regardless of the operation status.

- **Pr.77** can be set at any time regardless of the operation mode or operation status. (Setting through communication is unavailable.)

### ◆ Parameter write enabled only during stop (Pr.77 = "0 (initial value)")

- Parameters can be written only during a stop in the PU operation mode.
- The following parameters can always be written regardless of the operation mode or operation status.

Pr.	Name
4 to 6	(Multi-speed setting high-speed, middle-speed, low-speed)
22	Stall prevention operation level
24 to 27	(Multi-speed setting speed 4 to speed 7)
52	Operation panel main monitor selection
54	FM/CA terminal function selection
55	Frequency monitoring reference
56	Current monitoring reference
72 <sup>*1</sup>	PWM frequency selection
75	Reset selection/Disconnected PU detection/PU stop selection
77	Parameter write selection
79 <sup>*2</sup>	Operation mode selection
129	PID proportional band
130	PID integral time
133	PID action set point
134	PID differential time
158	AM terminal function selection
160	User group read selection
232 to 239	(Multi-speed setting speed 8 to speed 15)
240 <sup>*1</sup>	Soft-PWM operation selection
241	Analog input display unit switchover
268	Monitor decimal digits selection
271	High-speed setting maximum current
272	Middle-speed setting minimum current
273	Current averaging range
274	Current averaging filter time constant
275 <sup>*1</sup>	Stop-on contact excitation current low-speed scaling factor
290	Monitor negative output selection
295	Frequency change increment amount setting
296, 297	(Password setting)
306	Analog output signal selection
310	Analog meter voltage output selection
340 <sup>*2</sup>	Communication startup mode selection
345, 346	(DeviceNet communication)
416, 417	(PLC)
434, 435	(CC-Link communication)
496, 497	(Remote output)
498	PLC function flash memory clear
550 <sup>*2</sup>	NET mode operation command source selection

Pr.	Name
551 <sup>*2</sup>	PU mode operation command source selection
555 to 557	(Current average value monitoring)
656 to 659	(Analog remote output)
663	Control circuit temperature signal output level
675	User parameter auto storage function selection
750, 751	Motor thermistor interface
759	PID unit selection
774 to 776	(PU/DU monitor selection)
805	Torque command value (RAM)
806	Torque command value (RAM, EEPROM)
838	DA1 terminal function selection
866	Torque monitoring reference
888, 889	(Free parameter)
891 to 899	(Energy saving monitoring)
C0 (900)	FM/CA terminal calibration
C1 (901)	AM terminal calibration
C8 (930)	Current output bias signal
C9 (930)	Current output bias current
C10 (931)	Current output gain signal
C11 (931)	Current output gain current
990	PU buzzer control
991	PU contrast adjustment
992	Operation panel setting dial push monitor selection
997	Fault initiation
998 <sup>*2</sup>	PM parameter initialization
999 <sup>*2</sup>	Automatic parameter setting
1000	Direct setting selection
1006	Clock (year)
1007	Clock (month, day)
1008	Clock (hour, minute)
1018	Monitor with sign selection
1019	Analog meter voltage negative output selection
1048	Display-off waiting time
1142	Second PID unit selection
1150 to 1199	(PLC function user parameters)
1283	Home position return speed
1284	Home position return shifting speed

\*1 Writing during operation is enabled in PU operation mode, but disabled in External operation mode.

\*2 Writing during operation is disabled. To change the parameter setting value, stop the operation.

## ◆ Parameter write disabled (Pr.77 = "1")

- Parameter write, Parameter clear, and All parameter clear are disabled. (Parameter read is enabled.)
- The following parameters can be written even if Pr.77 = "1".

Pr.	Name
22	Stall prevention operation level
75	Reset selection/Disconnected PU detection/PU stop selection
77	Parameter write selection
79 <sup>*1</sup>	Operation mode selection
160	User group read selection
296	Password lock level
297	Password lock/unlock

Pr.	Name
345, 346	(DeviceNet communication)
496, 497	(Remote output)
656 to 659	(Analog remote output)
805	Torque command value (RAM)
806	Torque command value (RAM, EEPROM)
997	Fault initiation

\*1 Writing during operation is disabled. To change the parameter setting value, stop the operation.

## ◆ Parameter write enabled during operation (Pr.77 = "2")

- These parameters can always be written.
- The following parameters cannot be written during operation even if Pr.77 = "2". To change the parameter setting value, stop the operation.

Pr.	Name
23	Stall prevention operation level compensation factor at double speed
48	Second stall prevention operation level
49	Second stall prevention operation frequency
60	Energy saving control selection
61	Reference current
66	Stall prevention operation reduction starting frequency
71	Applied motor
79	Operation mode selection
80	Motor capacity
81	Number of motor poles
82	Motor excitation current
83	Rated motor voltage
84	Rated motor frequency
90 to 94	(Motor constant)
95	Online auto tuning selection
96	Auto tuning setting/status
135 to 139	(Electronic bypass sequence parameter)
178 to 196	(Input and output terminal function selection)
248	Self power management selection
254	Main circuit power OFF waiting time
261	Power failure stop selection
289	Inverter output terminal filter
291	Pulse train I/O selection
292	Automatic acceleration/deceleration
293	Acceleration/deceleration separate selection
298	Frequency search gain
313 to 322	(Extended output terminal function selection)
329	Digital input unit selection
373	Encoder position tuning setting/status
406	High resolution analog input selection
414	PLC function operation selection
415	Inverter operation lock mode setting
418	Extension output terminal filter
419	Position command source selection
420, 421	(Electronic gear)
450	Second applied motor
451	Second motor control method selection
453	Second motor capacity
454	Number of second motor poles

Pr.	Name
455	Second motor excitation current
456	Rated second motor voltage
457	Rated second motor frequency
458 to 462	(Second motor constant)
463	Second motor auto tuning setting/status
507, 508	(Display/reset ABC relay contact life)
541	Frequency command sign selection
560	Second frequency search gain
561	PTC thermistor protection level
570	Multiple rating setting
574	Second motor online auto tuning
598	Undervoltage level
606	Power failure stop external signal input selection
639, 640	(Brake sequence)
641, 650, 651	(Second brake sequence)
660 to 662	Increased magnetic excitation deceleration
673	SF-PR slip amount adjustment operation selection
699	Input terminal filter
702	Maximum motor frequency
706, 707, 711, 712, 717, 721, 724, 725, 1412	(PM motor tuning)
738 to 746, 1413	(Second PM motor tuning)
747	Second motor low-speed range torque characteristic selection
788	Low speed range torque characteristic selection
800	Control method selection
819	Easy gain tuning selection
858	Terminal 4 function assignment
859	Torque current/Rated PM motor current
860	Second motor torque current/Rated PM motor current
862	Encoder option selection
868	Terminal 1 function assignment
977	Input voltage mode selection
998	PM parameter initialization
999	Automatic parameter setting
1002	Lq tuning target current adjustment coefficient
1105	Encoder magnetic pole position offset
1292	Position control terminal input selection
1293	Roll feeding mode selection
1348	P/PI control switchover frequency



## 5.7.14 Password

Registering a 4-digit password can restrict access to parameters (reading/writing).

Pr.	Name	Initial value	Setting range	Description
296 E410	Password lock level	9999	0 to 6, 99, 100 to 106, 199	Password protection enabled. Setting the access (reading/writing) restriction level to parameters locked with a password enables writing to <b>Pr.297</b> .
			9999	No password protection
297 E411	Password lock/unlock	9999	1000 to 9998	Input a 4-digit password to lock parameters, or input the valid password to unlock the locked parameters.
			(0 to 5) <sup>*1</sup>	Number of failed password attempts (read only, displayed after any of "100 to 106, or 199" is set in <b>Pr.296</b> and a password to lock parameters is input).
			9999 <sup>*1</sup>	No password protection

These parameters can be set when **Pr.160 User group read selection** = "0". However, when **Pr.296** ≠ 9999 (password lock is set), **Pr.297** can always be set, regardless of the setting in **Pr.160**.

\*1 Although "0 or 9999" can be input in **Pr.297**, the value is invalid. (The display cannot be changed.)

### ◆ Parameter reading/writing restriction level (Pr.296)

- The access (reading/writing) restriction level to parameters in the PU operation mode or NET operation mode can be selected with **Pr.296**.

Pr.296 setting	PU operation mode operation command <sup>*3</sup>		NET operation mode operation command <sup>*4</sup>			
	Read <sup>*1</sup>	Write <sup>*2</sup>	RS-485 terminals / PLC function <sup>*7</sup>		via communication option	
			Read	Write <sup>*2</sup>	Read	Write <sup>*2</sup>
9999	○	○	○	○	○	○
0, 100 <sup>*6</sup>	×	×	×	×	×	×
1, 101	○	×	○	×	○	×
2, 102	○	×	○	○	○	○
3, 103	○	○	○	×	○	×
4, 104	×	×	×	×	○	×
5, 105	×	×	○	○	○	○
6, 106	○	○	×	×	○	×
99, 199	Only the parameters registered in the user group can be read/written. (For the parameters not registered in the user group, the restriction level when "4 or 104" is set applies.) <sup>*5</sup>					

○: Enabled, ×: Disabled

- \*1 If the parameter reading is restricted by the setting of **Pr.160 User group read selection**, those parameters cannot be read even when "○" is indicated.
- \*2 If the parameter writing is restricted by the setting of **Pr.77 Parameter write selection**, those parameters cannot be written even when "○" is indicated.
- \*3 Access from the command source in the PU operation mode (the operation panel (FR-DU08) or the parameter unit in the initial setting) is restricted. (For the PU operation mode command source selection, refer to [page 400](#).)
- \*4 Access from the command source in the Network operation mode (the RS-485 terminals or a communication option in the initial setting) is restricted. (For the NET operation mode command source selection, refer to [page 400](#).)
- \*5 Read/write is enabled only for the simple mode parameters registered in the user group when **Pr.160** = "9999". **Pr.296** and **Pr.297** can be read or written regardless of whether they are registered to the user group.
- \*6 If a communication option is installed, the Option fault (E.OPT) occurs, and the inverter output shuts off. (Refer to [page 791](#).)
- \*7 The PLC function user parameters (**Pr.1150 to Pr.1199**) can be written and read by the PLC function regardless of the **Pr.296** setting.

### ◆ Locking parameters with a password (Pr.296, Pr.297)

- The procedure of locking parameters with a password is as follows.

- Set the parameter reading/writing restriction level to enable the password protection. (Set a value other than "9999" in **Pr.296**.)

Pr.296 setting	Allowable number of failed password attempts	Pr.297 readout
0 to 6 or 99	Unlimited	Always 0
100 to 106, 199 <sup>*1</sup>	Limited to 5 times	Number of failed password attempts (0 to 5)

- \*1 If an invalid password is input 5 times while any of "100 to 106, or 199" is set in **Pr.296**, the password is locked up afterward (the locked parameters cannot be unlocked even with the valid password). All parameter clear is required to reset the password. (After All parameter clear is performed, the parameters are returned to their initial values.)

2. Write a four-digit number (1000 to 9998) to **Pr.297** as a password (writing is disabled when **Pr.296** = "9999"). After a password is set, parameters are locked and access (reading/writing) to the parameters is limited at the level set in **Pr.296** until the valid password is input to unlock the locked parameters.

**NOTE**

- After a password is set, the **Pr.297** readout is always any of "0 to 5".
- "LOCD" appears when a password-protected parameter is attempted to be read/written.
- Even if a password is set, the parameters which are written by the inverter, such as parameters related to the life check of inverter parts, are overwritten as needed.
- Even if a password is set, **Pr.991 PU contrast adjustment** can be read/written when the parameter unit (FR-PU07) is connected.

◆ **Unlocking the locked parameters (Pr.296, Pr.297)**

- There are two ways to unlock the locked parameters.
- Enter the password in **Pr.297**. When a valid password is input, the locked parameters can be unlocked. When an invalid password is input, an error indication appears and the parameters cannot be unlocked. If an invalid password is input 5 times while any of "100 to 106, or 199" is set in **Pr.296**, the locked parameters cannot be unlocked afterward even with the valid password (the password is locked up).
- Perform All parameter clear.

**NOTE**

- If the password is forgotten, it can be reset by performing All parameter clear, but the other parameters are also reset.
- All parameter clear cannot be performed during the inverter operation.
- When using FR Configurator2 in the PU operation mode, do not set "0, 4, 5, 99, 100, 104, 105, or 199" (parameter read is disabled) in **Pr.296**. Doing so may cause abnormal operation.
- The means to reset the password varies according to how the reset command is sent (from the PU, through RS-485 communication, or via a communication option).

	PU (operation panel or parameter unit)	RS-485 communication	Communication option
All parameter clear	○	○	○
Parameter clear	×	×	○

- : Password reset enabled, ×: Password reset disabled
- For the information how to perform Parameter clear or All parameter clear with the parameter unit or via a communication option, refer to the Instruction Manual of the parameter unit or the option. (For the operation panel (FR-DU08), refer to [page 743](#). For RS-485 communication using the Mitsubishi inverter protocol, refer to [page 672](#). For RS-485 communication using the MODBUS RTU communication protocol, refer to [page 686](#).)

◆ **Access to parameters according to the password status**

Parameter		Password protection disabled / Parameters unlocked		Parameters locked	Password locked up
		Pr.296 = "9999", Pr.297 = "9999"	Pr.296 ≠ "9999", Pr.297 = "9999"	Pr.296 ≠ "9999", Pr.297 = "0 to 4" (read value)	Pr.296 = "100 to 106, 199" Pr.297 = "5" (read value)
Pr.296	Read	○ <sup>*1</sup>	○	○	○
	Write	○ <sup>*1</sup>	○ <sup>*1</sup>	×	×
Pr.297	Read	○ <sup>*1</sup>	○	○	○
	Write	×	○	○	○ <sup>*3</sup>
Pr.CLR write (Parameter clear)		○	○	× <sup>*4</sup>	× <sup>*4</sup>
ALL.C write (All parameter clear)		○	○	○ <sup>*2</sup>	○ <sup>*2</sup>
Pr.CPY write (Parameter copy)		○	○	×	×

○: Enabled, ×: Disabled

<sup>\*1</sup> Reading/writing is disabled if reading is restricted by the **Pr.160** setting. (Reading is available in the Network operation mode regardless of the **Pr.160** setting.)

<sup>\*2</sup> All parameter clear cannot be performed during the operation.

- \*3 Inputting a password is possible but the locked-up password cannot be unlocked or reset even with the valid password.
- \*4 Parameter clear can be performed only via a communication option.

**NOTE**

- When "4, 5, 104, or 105" is set in **Pr.296** and a password is set, **Pr.15 Jog frequency** is not listed on the parameter unit (FR-PU07).
- When a password has been set and parameters are locked, Parameter copy cannot be performed using the operation panel, parameter unit, or a USB memory device.

«Parameters referred to»

- Pr.77 Parameter write selection [page 345](#)
- Pr.160 User group read selection [page 354](#)
- Pr.550 NET mode operation command source selection [page 400](#)
- Pr.551 PU mode operation command source selection [page 400](#)

## 5.7.15 Free parameter

Any number within the setting range of 0 to 9999 can be input.

For example, these numbers can be used:

- As a unit number when multiple units are used.
- As a pattern number for each operation application when multiple units are used.
- As the year and month of introduction or inspection.

Pr.	Name	Initial value	Setting range	Description
888 E420	Free parameter 1	9999	0 to 9999	Any value can be input. The settings are retained even if the inverter power is turned OFF.
889 E421	Free parameter 2	9999	0 to 9999	

**NOTE**

- **Pr.888** and **Pr.889** do not influence the operation of the inverter.

## 5.7.16 Setting multiple parameters by batch

The setting of particular parameters is changed by batch, such as communication parameters for connection with the Mitsubishi Electric human machine interface (GOT), the parameters for the rated frequency (50/60 Hz) setting, or the parameters for acceleration/deceleration time increment.

Multiple parameters are changed automatically. Users do not have to consider each parameter number (automatic parameter setting).

Pr.	Name	Initial value	Setting range	Description	
999 E431	Automatic parameter setting	9999*1	1	Standard PID display setting	
			2	Extended PID display setting	
			10	GOT initial setting (PU connector)	"Controller Type" in GOT: FREQROL 500/700/800, SENSORLESS SERVO
			11	GOT initial setting (RS-485 terminal)	
			12	GOT initial setting (PU connector)	"Controller Type" in GOT: FREQROL 800 (Automatic Negotiation)
			13	GOT initial setting (RS-485 terminal)	
			20	50 Hz rated frequency	
			21	60 Hz rated frequency	
			9999	No action	

\*1 The read value is always "9999".

## ◆ Automatic parameter setting (Pr.999)

- Select which parameters to automatically set from the following table, and set them in **Pr.999**. Multiple parameter settings are changed automatically. Refer to [page 352](#) for the list of parameters that are changed automatically.

Pr.999 setting	Description	Operation in the automatic parameter setting mode
1	Sets the standard monitor indicator setting of PID control.	"AUFD" (AUTO) → "PI d" (PID) → Write "1".
2	Automatically sets the monitor indicator for PID control.	"AUFD" (AUTO) → "PI d" (PID) → Write "2".
10	Automatically sets the communication parameters for the GOT connection with a PU connector ("Controller Type" in GOT: FREQROL 500/700/800, SENSORLESS SERVO)	"AUFD" (AUTO) → "GOT" (GOT) → Write "1".
11	Automatically sets the communication parameters for the GOT connection with RS-485 terminals ("Controller Type" in GOT: FREQROL 500/700/800, SENSORLESS SERVO)	—
12	Automatically sets the communication parameters for the GOT connection with a PU connector ("Controller Type" in GOT: FREQROL 800 (Automatic Negotiation))	"AUFD" (AUTO) → "GOT" (GOT) → Write "2".
13	Automatically sets the communication parameters for the GOT connection with RS-485 terminals ("Controller Type" in GOT: FREQROL 800 (Automatic Negotiation))	—
20	50 Hz rated frequency	Sets the related parameters of the rated frequency according to the power supply frequency "AUFD" (AUTO) → "F50" (F50) → Write "1".
21	60 Hz rated frequency	

### NOTE

- If the automatic setting is performed with **Pr.999** or the automatic parameter setting mode, the settings including the changed parameter settings (changed from the initial setting) will be automatically changed. Before performing the automatic setting, confirm that changing the parameters will not cause any problem.

## ◆ PID monitor indicator setting (Pr.999 = "1 or 2")

Pr.	Name	Initial value	Pr.999 = "1"	Pr.999 = "2"	Refer to page
759	PID unit selection	9999	9999	4	615
1142	Second PID unit selection	9999	9999	4	
774	Operation panel monitor selection 1	9999	9999	52	446
775	Operation panel monitor selection 2	9999	9999	53	
776	Operation panel monitor selection 3	9999	9999	54	
C42 (934)	PID display bias coefficient	9999	9999	0	615
C44 (935)	PID display gain coefficient	9999	9999	100	
1136	Second PID display bias coefficient	9999	9999	0	
1138	Second PID display gain coefficient	9999	9999	100	
—	3-line monitor setting	—	Invalid	Enabled <sup>*1*2*3</sup>	—
—	Direct setting	—	Invalid	Enabled <sup>*3</sup>	—
—	Dedicated parameter list function	—	Invalid	Enabled <sup>*3</sup>	—

\*1 Enabled when the FR-LU08 (-01) is used.

\*2 Enabled when the FR-PU07 is used.

\*3 Enabled when the FR-PU07-01 is used.

### ■ 3-line monitor setting

On the operation panel or parameter unit, the 3-line monitor is used as the first monitor.

### ■ Direct setting

Pressing the [FUNC] key on the FR-PU07-01 displays the direct setting screen. The PID action set point can be directly set regardless of the operation mode or **Pr.77 Parameter write selection** setting.

Pressing the [FUNC] key on the direct setting screen displays the function menu.

Direct setting	Parameter to be set
Direct setting 1	Pr.133 PID action set point
Direct setting 2	Pr.755 Second PID action set point

### ■ Dedicated parameter list function

Pressing the [PrSET] key of the FR-PU07-01 displays the dedicated parameter list. Parameters that need to be set first for the PID extended display setting are listed.

Dedicated parameter list	Parameter to be set
No.1	Pr.999 Automatic parameter setting
No.2	Pr.934 PID display bias coefficient
No.3	Pr.935 PID display bias analog value

#### NOTE

- The display of parameters other than the above may be changed due to changes in **C42** or **C44**. Set the PID monitor indicator before changing the settings of other parameters.
- To use the direct setting on the LCD operation panel, set **Pr.1000 Direct setting selection**. (Refer to [page 340](#).)

### ◆ GOT initial setting (PU connector) (Pr.999 = "10, 12")

Pr.	Name	Initial value	Pr.999 = "10"	Pr.999 = "12"	Refer to page
79	Operation mode selection	0	1	1	389
118	PU communication speed	192	192	1152	670
119	PU communication stop bit length / data length	1	10	0	
120	PU communication parity check	2	1	1	
121	PU communication retry count	1	9999	9999	
122	PU communication check time interval	9999	9999	9999	
123	PU communication waiting time setting	9999	0 ms	0 ms	
124	PU communication CR/LF selection	1	1	1	
340	Communication startup mode selection	0	0	0	
414	PLC function operation selection	0	—	2 <sup>*1</sup>	646

\*1 The setting is changed when **Pr.414** = "0" (initial setting).

### ■ Initial setting with the GOT2000 series

- When "FREQROL 500/700/800, SENSORLESS SERVO" is selected for "Controller Type" in the GOT setting, set **Pr.999** = "10" to configure the GOT initial setting.
- When "FREQROL 800 (Automatic Negotiation)" is selected for "Controller Type" in the GOT setting, the GOT automatic connection can be used. When "FREQROL 800 (Automatic Negotiation)" is selected for "Controller Type" in the GOT setting and the GOT automatic connection is not used, set **Pr.999** = "12" to configure the GOT initial setting. (Refer to [page 701](#).)

### ■ Initial setting with the GOT1000 series

- Set **Pr.999** = "10" to configure the GOT initial setting.

#### NOTE

- Always perform an inverter reset after the initial setting.
- For details on connection with GOT, refer to the Instruction Manual of GOT.

## ◆ GOT initial setting (RS-485 terminals) (Pr.999 = "11, 13")

Pr.	Name	Initial value	Pr.999 = "11"	Pr.999 = "13"	Refer to page
79	Operation mode selection	0	0	0	389
332	RS-485 communication speed	96	192	1152	670
333	RS-485 communication stop bit length / data length	1	10	0	
334	RS-485 communication parity check selection	2	1	1	
335	RS-485 communication retry count	1	9999	9999	
336	RS-485 communication check time interval	0 s	9999	9999	
337	RS-485 communication waiting time setting	9999	0 ms	0 ms	
340	Communication startup mode selection	0	1	1	
341	RS-485 communication CR/LF selection	1	1	1	670
414	PLC function operation selection	0	—	2 <sup>*1</sup>	646
549	Protocol selection	0	0	0	686

\*1 The setting is changed when Pr.414 = "0" (initial setting).

### ■ Initial setting with the GOT2000 series

- When "FREQROL 500/700/800, SENSORLESS SERVO" is selected for "Controller Type" in the GOT setting, set Pr.999 = "11" to configure the GOT initial setting.
- When "FREQROL 800 (Automatic Negotiation)" is selected for "Controller Type" in the GOT setting, the GOT automatic connection can be used. When "FREQROL 800 (Automatic Negotiation)" is selected for "Controller Type" in the GOT setting and the GOT automatic connection is not used, set Pr.999 = "13" to configure the GOT initial setting. (Refer to [page 701](#).)

### ■ Initial setting with the GOT1000 series

- Set Pr.999 = "11" to configure the GOT initial setting.

#### NOTE

- Always perform an inverter reset after the initial setting.
- For details on connection with GOT, refer to the Instruction Manual of GOT.

## ◆ Rated frequency (Pr.999 = "20" (50 Hz) or "21" (60 Hz))

Pr.	Name	Initial value		Pr.999 = "21"	Pr.999 = "20"	Refer to page
		FM type	CA type			
3	Base frequency	60 Hz	50 Hz	60 Hz	50 Hz	707
4	Multi-speed setting (high speed)	60 Hz	50 Hz	60 Hz	50 Hz	411
20	Acceleration/deceleration reference frequency	60 Hz	50 Hz	60 Hz	50 Hz	367
37	Speed display	0		0		444
55	Frequency monitoring reference	60 Hz	50 Hz	60 Hz	50 Hz	457
66	Stall prevention operation reduction starting frequency	60 Hz	50 Hz	60 Hz	50 Hz	431
116	Third output frequency detection	60 Hz	50 Hz	60 Hz	50 Hz	431
125 (903)	Terminal 2 frequency setting gain frequency	60 Hz	50 Hz	60 Hz	50 Hz	505
126 (905)	Terminal 4 frequency setting gain frequency	60 Hz	50 Hz	60 Hz	50 Hz	
263	Subtraction starting frequency	60 Hz	50 Hz	60 Hz	50 Hz	642
266	Power failure deceleration time switchover frequency	60 Hz	50 Hz	60 Hz	50 Hz	
386	Frequency for maximum input pulse	60 Hz	50 Hz	60 Hz	50 Hz	406
505	Speed setting reference	60 Hz	50 Hz	60 Hz	50 Hz	444
808	Forward rotation speed limit/speed limit	60 Hz	50 Hz	60 Hz	50 Hz	287
C14 (918)	Terminal 1 gain frequency (speed)	60 Hz	50 Hz	60 Hz	50 Hz	505

## 5.7.17 Extended parameter display and user group function

This function restricts the parameters that are read by the operation panel and parameter unit.

Pr.	Name	Initial value	Setting range	Description
<b>160</b> <b>E440</b>	<b>User group read selection</b>	0	9999	Only simple mode parameters are displayed.
			0	Displays simple mode and extended parameters.
			1	Only parameters registered in user groups are displayed.
<b>172</b> <b>E441</b>	<b>User group registered display/batch clear</b>	0	(0 to 16)	Displays the number of parameters that are registered in the user groups. (Read-only)
			9999	Batch clear of user group registrations
<b>173</b> <b>E442</b>	<b>User group registration</b>	9999*1	0 to 1999, 9999	Sets the parameter number to register for the user group.
<b>174</b> <b>E443</b>	<b>User group clear</b>	9999*1	0 to 1999, 9999	Sets the parameter number to clear from the user group.

\*1 The read value is always "9999".

## ◆ Display of simple mode parameters and extended parameters (Pr.160)

- When **Pr.160** = "9999", only the simple mode parameters are displayed on the operation panel (FR-DU08) and parameter unit (FR-PU07). (For the simple mode parameters, refer to the parameter list on [page 166](#).)
- With the initial value (**Pr.160** = "0", simple mode parameters and extended parameters can be displayed.

**NOTE**

- When a plug-in option is installed on the inverter, the option parameters can also be read.
- Every parameter can be read regardless of the **Pr.160** setting when reading parameters via a communication option.
- When reading the parameters using the RS-485 terminals, all parameters can be read regardless of the **Pr.160** setting by setting **Pr.550 NET mode operation command source selection** and **Pr.551 PU mode operation command source selection**.

Pr.551	Pr.550	Pr.160 enabled/disabled
1 (RS-485)	—	Enabled
2 (PU), 3 (USB), 9999 (Automatic determination) (initial value)	0 (Communication option)	Enabled
	1 (RS-485)	Disabled (All can be read)
	9999 (Automatic determination) (initial value)	With communication option: Enabled Without communication option: Disabled (All can be read)

- When the LCD operation panel (FR-LU08) or the parameter unit (FR-PU07) is installed, **Pr.15 Jog frequency**, **Pr.16 Jog acceleration/deceleration time**, **C42 (Pr.934) PID display bias coefficient**, **C43 (Pr.934) PID display bias analog value**, **C44 (Pr.935) PID display gain coefficient**, **C45 (Pr.935) PID display gain analog value**, **Pr.991 PU contrast adjustment**, **Pr.1136 Second PID display bias coefficient**, **Pr.1137 Second PID display bias analog value**, **Pr.1138 Second PID display gain coefficient**, and **Pr.1139 Second PID display gain analog value** are displayed as simple mode parameters.







**◆ User group function (Pr.160, Pr.172 to Pr.174)**

- The user group function is a function for displaying only the parameters required for a setting.
- A maximum of 16 parameters from any of the parameters can be registered in a user group. When **Pr.160** = "1", reading/writing is enabled only for the parameters registered in user groups. (Parameters not registered in user groups can no longer be read.)
- To register a parameter in a user group, set the parameter number in **Pr.173**.
- To clear a parameter from a user group, set the parameter number in **Pr.174**. To batch clear all the registered parameters, set **Pr.172** = "9999".

**◆ Registering a parameter in a user group (Pr.173)**

- To register **Pr.3** in a user group

**Operating procedure**







- 1.** Power ON  
Make sure the motor is stopped.
- 2.** Changing the operation mode  
Press  to choose the PU operation mode. [PU] indicator turns ON.
- 3.** Selecting the parameter setting mode  
Press  to choose the parameter setting mode. (The parameter number read previously appears)
- 4.** Selecting a parameter  
Turn  until "P. 173" (**Pr.173**) appears.
- 5.** Parameter read  
Press . "9999" appears.
- 6.** Parameter registration  
Turn  until "3" (**Pr.3**) appears. Press  to register the parameter.  
"P. 173" and "3" are displayed alternately.  
To continue adding parameters, repeat steps 5 and 6.



## ◆ Clearing a parameter from a user group (Pr.174)

- To delete Pr.3 from a user group.

### Operating procedure

1. Power ON  
Make sure the motor is stopped.
2. Changing the operation mode  
Press  to choose the PU operation mode. [PU] indicator turns ON.
3. Selecting the parameter setting mode  
Press  to choose the parameter setting mode. (The parameter number read previously appears)
4. Selecting a parameter  
Turn  until "P. 174" (Pr.174) appears.
5. Parameter read  
Press . "9999" appears.
6. Clearing the parameter  
Turn  until "3" (Pr.3) appears. Press  to delete the parameter.  
"P. 174" and "3" are displayed alternately.  
To continue deleting parameters, repeat steps 5 and 6.

### NOTE

- Pr.77 Parameter write selection, Pr.160, Pr.296 Password lock level, Pr.297 Password lock/unlock and Pr.991 PU contrast adjustment can always be read regardless of the user group setting. (For Pr.991, only when the FR-LU08 or the FR-PU07 is connected.)
- Pr.77, Pr.160, Pr.172 to Pr.174, Pr.296, and Pr.297 cannot be registered in a user group.
- When Pr.174 is read, "9999" is always displayed. "9999" can be written, but it does not function.
- Pr.172 is disabled if set to a value other than "9999".

### Parameters referred to

Pr.15 Jog frequency, Pr.16 Jog acceleration/deceleration time [page 410](#)  
 Pr.77 Parameter write selection [page 345](#)  
 Pr.296 Password lock level, Pr.297 Password lock/unlock [page 348](#)  
 Pr.550 NET mode operation command source selection [page 400](#)  
 Pr.551 PU mode operation command source selection [page 400](#)  
 Pr.991 PU contrast adjustment [page 340](#)

## 5.7.18 PWM carrier frequency and Soft-PWM control

The motor sound can be changed.

Pr.	Name	Initial value	Setting range	Description
72 E600	PWM frequency selection	2	0 to 15*1	The PWM carrier frequency can be changed. The setting value represents the frequency in kHz. However, "0" indicates 0.7 kHz, "15" indicates 14.5 kHz, and "25" indicates 2.5 kHz. (The setting value "25" is for the sine wave filter only.)
			0 to 6, 25*2	
240 E601	Soft-PWM operation selection	1	0	Soft-PWM control disabled.
			1	Soft-PWM control enabled.
260 E602	PWM frequency automatic switchover	1	0	PWM carrier frequency automatic reduction function disabled (for the LD, ND, or HD rating)
			1	PWM carrier frequency automatic reduction function enabled

\*1 The setting range of the FR-A820-03160(55K) or lower and the FR-A840-01800(55K) or lower

\*2 The setting range of the FR-A820-03800(75K) or higher and the FR-A840-02160(75K) or higher

## ◆ Changing the PWM carrier frequency (Pr.72)

- The PWM carrier frequency of the inverter can be changed.
- Changing the PWM carrier frequency can be effective for avoiding the resonance frequency of the mechanical system or motor, as a countermeasure against EMI generated from the inverter, or for reducing leakage current caused by PWM switching.
- Under Real sensorless vector control, vector control, and PM sensorless vector control, the following carrier frequencies are used.

(For the control method and fast-response mode selection, refer to **Pr.800 Control method selection** on [page 221](#).)

Pr.72 setting	Carrier frequency (kHz)		
	Real sensorless vector control, Vector control	PM sensorless vector control,	Fast-response mode
0	2	6 <sup>*1</sup>	4
1			
2			
3			
4			
5	6 <sup>*2</sup>	6	8
6			
7			
8			
9			
10	10 <sup>*2</sup>	10	12
11			
12			
13			
14			
15	14 <sup>*2</sup>	14	

\*1 When low-speed range high-torque characteristic is disabled (**Pr.788** = "0"), 2 kHz is used.

\*2 In the low-speed range (less than 3 Hz) under Real sensorless vector control, the carrier frequency is automatically changed to 2 kHz.  
(For the FR-A820-00490(7.5K) or lower and the FR-A840-00250(7.5K) or lower)

- When using an optional sine wave filter (MT-BSL/BSC), set "25" (2.5 kHz) in **Pr.72**. (FR-A820-03800(75K) or higher, FR-A840-02160(75K) or higher.)

### NOTE

- In the low-speed range (less than about 10 Hz), the carrier frequency may be automatically lowered. Motor noise increases, but not to the point of failure.
- When **Pr.72** = "25", the following limitations apply.
  - V/F control is forcibly set.
  - Soft-PWM control is disabled.
  - The maximum output frequency is 60 Hz.

## ◆ Soft-PWM control (Pr.240)

- Soft-PWM control is a function that changes the motor noise from a metallic sound into an inoffensive, complex tone.
- Setting **Pr.240** = "1" will enable the Soft-PWM control.
- To enable the Soft-PWM control, set **Pr.72** to 5 kHz or less for the FR-A820-03160(55K) or lower or the FR-A840-01800(55K) or lower. For the FR-A820-03800(75K) or higher or the FR-A840-02160(75K) or higher, set **Pr.72** to 4 kHz or less.

### NOTE

- While a sine wave filter (**Pr.72** = "25") is being used, the Soft-PWM control is disabled.

## ◆ PWM carrier frequency automatic reduction function (Pr.260)

- Setting **Pr.260** = "1 (initial value)" will enable the PWM carrier frequency auto-reduction function. If a heavy load is continuously applied while the inverter carrier frequency is set to 3 kHz or higher (**Pr.72** ≥ "3"), the carrier frequency is automatically reduced to prevent occurrence of the inverter overload trip (electronic thermal O/L relay function) (E.THT). The carrier frequency is reduced to as low as 2 kHz. Motor noise increases, but not to the point of failure.
- When the carrier frequency automatic reduction function is used, operation with the carrier frequency set to 3 kHz or higher (**Pr.72** ≥ 3) automatically reduces the carrier frequency for heavy-load operation as shown below.

Pr.260 setting	Pr.570 setting	Carrier frequency automatic reduction operation	
		FR-A820-04750(90K) or lower, FR-A840-02600(90K) or lower	FR-A840-03250(110K) or higher
1	0 (SLD), 1 (LD)	The carrier frequency will reduce automatically with continuous operation of 85% of the inverter rated current or higher.	
	2 (ND), 3 (HD)	The carrier frequency will reduce automatically with operation of 150% of the inverter ND rated current or higher.	Continuous operation with the 85% or higher inverter rated current for the ND rating reduces the carrier frequency automatically.
0	0 (SLD)	The carrier frequency will reduce automatically with continuous operation of 85% of the inverter rated current or higher.	
	1 (LD)	Without carrier frequency automatic reduction (Perform continuous operation with the carrier frequency set to 2 kHz or lower or with less than 85% of the inverter rated current for the ND rating.)	
	2 (ND), 3 (HD)	Without carrier frequency automatic reduction	Without carrier frequency automatic reduction (Perform continuous operation with the carrier frequency set to 2 kHz or lower or with less than 85% of the inverter rated current for the ND rating.)

### NOTE

- Reducing the PWM carrier frequency is effective as a countermeasure against EMI from the inverter or for reducing leakage current, but doing so increases the motor noise.
- When the PWM carrier frequency is set to 1 kHz or lower (**Pr.72** ≤ 1), the increase in the harmonic current causes the fast-response current limit to activate before the stall prevention operation, which may result in torque shortage. In this case, disable the fast-response current limit in **Pr.156 Stall prevention operation selection**.
- The lower limit of carrier frequency after the reduction under PM sensorless vector control (low-speed range high-torque characteristic enabled) is 6 kHz.
- During fast-response operation, the carrier frequency automatic reduction function is disabled.

### Parameters referred to

Pr.156 Stall prevention operation selection [page 431](#)

Pr.570 Multiple rating setting [page 343](#)

Pr.788 Low speed range torque characteristic selection [page 233](#)

Pr.800 Control method selection [page 221](#)

## 5.7.19 Inverter parts life display

The degree of deterioration of the control circuit capacitor, main circuit capacitor, cooling fan, inrush current limit circuit, and relay contacts of terminals A, B, and C can be diagnosed on the monitor. When a part approaches the end of its life, an alarm can be output by self diagnosis to prevent a fault. (Note that the life diagnosis of this function should be used as a guideline only, because with the exception of the main circuit capacitor, the life values are theoretical calculations.)

Pr.	Name	Initial value	Setting range	Description
255 E700	Life alarm status display	0	(0 to 255) <sup>*1</sup>	Displays whether or not the parts of the control circuit capacitor, main circuit capacitor, cooling fan, and inrush current limit circuit have reached the life alarm output level. Read-only.
256 E701 <sup>*2</sup>	Inrush current limit circuit life display	100%	(0 to 100%)	Displays the degree of deterioration for the inrush current limit circuit. Read-only.
257 E702	Control circuit capacitor life display	100%	(0 to 100%)	Displays the degree of deterioration for the control circuit capacitor. Read-only.
258 E703 <sup>*2</sup>	Main circuit capacitor life display	100%	(0 to 100%)	Displays the degree of deterioration for the main circuit capacitor. Read-only. The value measured by Pr.259 is displayed.
259 E704 <sup>*2</sup>	Main circuit capacitor life measuring	0	0, 1 (2, 3, 8, 9)	Setting "1" and turning the power supply OFF starts the measurement of the main circuit capacitor life. If the setting value of Pr.259 becomes "3" after turning the power supply ON again, it means that the measurement is completed. The degree of deterioration is read to Pr.258.
			11 (12, 13, 18, 19)	When "11" is set, turning OFF the power supply starts the measurement of the main circuit capacitor life. If the setting value of Pr.259 becomes "13" after turning the power supply ON again, it means that the measurement is completed. The degree of deterioration is read to Pr.258.
506 E705 <sup>*2</sup>	Display estimated main circuit capacitor residual life	100%	(0 to 100%)	Displays the estimated residual life of the main circuit capacitor. Read-only.
507 E706	Display/reset ABC1 relay contact life	100%	0 to 100%	Displays the degree of deterioration of the relay contacts of terminals A1, B1, and C1.
508 E707	Display/reset ABC2 relay contact life	100%	0 to 100%	Displays the degree of deterioration of the relay contacts of terminals A2, B2, and C2.

\*1 The setting range (read-only) differs depending on the inverter model (standard model, separate converter type, or IP55 compatible model).

\*2 The setting is available for the standard structure model and the IP55 compatible model.

### ◆ Life alarm display and signal output (Y90 signal, Pr.255)

#### Point

- In the life diagnosis of the main circuit capacitor, the Life alarm (Y90) signal is not output unless measurement by turning OFF the power supply is performed.

- Whether or not the parts of the control circuit capacitor, main circuit capacitor, cooling fan, inrush current limit circuit, internal air circulation fans, or relay contacts of terminals A, B, and C have reached the life alarm output level can be checked with **Pr.255 Life alarm status display** and the Life alarm (Y90) signal. (Internal air circulation fans are equipped with IP55 compatible models.)

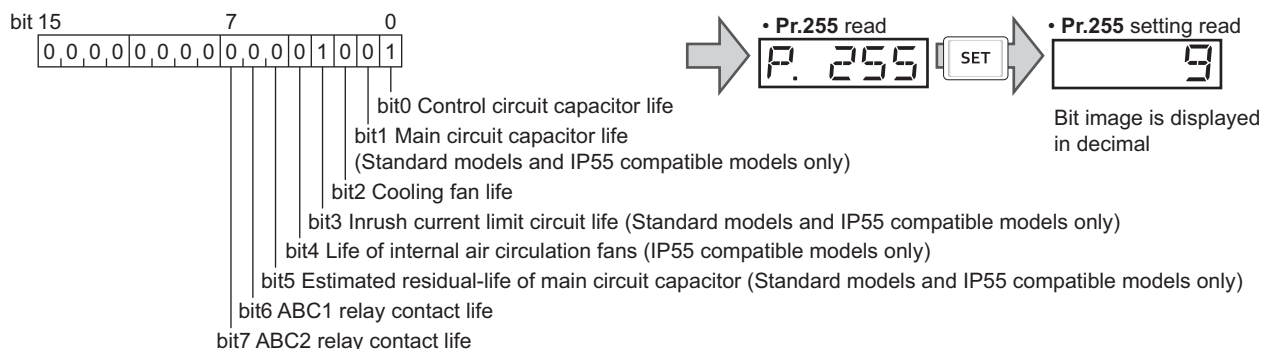

- When the parts have reached the life alarm output level, the corresponding bits of **Pr.255** turns ON. The ON/OFF state of the bits can be checked with **Pr.255**. The following table shows examples.

Pr.255		bit 7	bit 6	bit 5	bit 4	bit 3	bit 2	bit 1	bit 0	Remarks
Decimal	Binary									
239	11101111	○	○	○	×	○	○	○	○	All parts have reached alarm output level for standard structure models.
5	101	×	×	×	×	×	○	×	○	Control circuit capacitor and cooling fan have reached alarm output level.
0	0	×	×	×	×	×	×	×	×	No parts have reached alarm output level.

○: Parts reaching alarm output level ×: Parts not reaching alarm output level

- Diagnosable parts differ depending on the type of the inverter.

Part	Applicable inverter		
	Standard model	Separated converter type	IP55 compatible model
Control circuit capacitor	○	○	○
Main circuit capacitor	○	×	○
Cooling fan	○	○	○
Inrush current limit circuit	○	×	○
Internal air circulation fan	×	×	○
Main circuit capacitor (estimated residual life)	○	×	○
ABC relay contact	○	○	○

○: Diagnosable, ×: Undiagnosable

- The Life alarm (Y90) signal turns ON when the life alarm output level is reached for either of the following: the control circuit capacitor life, main circuit capacitor life, cooling fan life, inrush current limit circuit life, internal air circulation fan life, estimated residual-life of the main circuit capacitor, ABC1 relay contact life, or ABC2 relay contact life.
- For the terminal used for the Y90 signal, set "90" (positive logic) or "190" (negative logic) in any of **Pr.190 to Pr.196 (Output terminal function selection)**.

#### NOTE

- When using an option (FR-A8AY, FR-A8AR, FR-A8NC, FR-A8NCE, or FR-A8NCG), warning signals can be output individually: the Control circuit capacitor life (Y86) signal, Main circuit capacitor life (Y87) signal, Cooling fan life (Y88) signal, Inrush current limit circuit life (Y89) signal, Estimated residual-life of main circuit capacitor (Y248) signal, ABC1 relay contact life (Y249) signal, and ABC2 relay contact life (Y250) signal.
- Changing the terminal assignment using **Pr.190 to Pr.196 (Output terminal function selection)** may affect the other functions. Set parameters after confirming the function of each terminal.

### ◆ Life display of the inrush current limit circuit (Pr.256) (Standard models and IP55 compatible models)

- The life of the inrush current limit circuit (relay, contactor and inrush resistor) is displayed in **Pr.256**.
- The number of contact (relay, contactor, thyristor) ON times is counted, and it is counted down from 100% (0 time) every 1%/10,000 times. When the counter reaches 10% (900,000 times), bit 3 of **Pr.255** is turned ON (set to 1) and the Y90 signal is also output as an alert.

### ◆ Life display of the control circuit capacitor (Pr.257)

- The degree of deterioration for the control circuit capacitor is displayed in **Pr.257**.
- In the operating status, the control circuit capacitor life is calculated from the energization time and temperature, and is counted down from 100%. When the counter goes down from 10%, bit 0 of **Pr.255** is turned ON (set to 1) and the Y90 signal is also output as an alert.

## ◆ Life display of the main circuit capacitor (Pr.258, Pr.259) (Standard models and IP55 compatible models)

### Point

- For accurate life measurement of the main circuit capacitor, wait three hours or longer after turning OFF. The temperature left in the main circuit capacitor affects measurement.

- The degree of deterioration for the main circuit capacitor is displayed in **Pr.258**.
- With the main circuit capacitor capacity at factory shipment as 100%, the capacitor life is displayed in **Pr.258** every time measurement is made. When the measured value falls to 85% or lower, bit 1 of **Pr.255** is turned ON (set to 1) and the Y90 signal is also output as an alert.
- Measure the capacitor capacity according to the following procedure and check the degree of deterioration for the capacitor capacity.
  1. Check that the motor is connected and at a stop.
  2. Set "1 or 11" (measuring start) in **Pr.259**.
  3. Switch the power OFF. The inverter applies DC voltage to the motor to measure the capacitor capacity while the inverter is OFF.
  4. After confirming that the power lamp is OFF, turn ON the power again.
  5. Check that "3 or 13" (measurement complete) is set in **Pr.259**, read **Pr.258**, and check the degree of deterioration for the main circuit capacitor.

Pr.259	Description	Remarks
0	No measurement	Initial value
1, 11	Start measurement	Measurement starts when the power supply is switched OFF. (Only once when <b>Pr.259</b> = "1") When <b>Pr.259</b> = "11", the measurement starts every time the power supply is turned OFF.
2, 12	During measurement	Only displayed and cannot be set. (When "11" is set in <b>Pr.259</b> , "12, 13, 18, or 19" is displayed.)
3, 13	Measurement complete	
8, 18	Forced end	
9, 19	Measurement error	

### NOTE

- When the main circuit capacitor life is measured under the following conditions, "forced end" (**Pr.259** = "8 or 18"), or "measurement error" (**Pr.259** = "9 or 19") may occur, or the status may remain in "measurement start" (**Pr.259** = "1 or 11"). To perform measurement, first eliminate the following conditions. Under the following conditions, even if "measurement complete" (**Pr.259** = "3 or 13") is reached, measurement cannot be performed correctly.
  - FR-HC2, FR-XC (common bus regeneration mode), FR-CV, MT-RC, or a sine wave filter (when **Pr.72** = "25") is connected.
  - Terminals R1/L11, S1/L21 or DC power supply is connected to terminals P/+ and N/-.
  - The power supply is switched ON during measurement.
  - The motor is not connected to the inverter.
  - The motor is running (coasting).
  - The motor capacity is smaller than the inverter capacity by two ranks or more.
  - The inverter output is shut off or a fault occurred while the power was OFF.
  - The inverter output is shut off with the MRS signal.
  - The start command is given while measuring.
  - The applied motor setting is incorrect.
- Operation environment: Surrounding air temperature (annual average of 40°C (free from corrosive gas, flammable gas, oil mist, dust and dirt)).  
Output current: 80% of the inverter rating
- Since repeated inrush currents at power ON will shorten the life of the converter circuit, frequent starts and stops of the magnetic contactor must be avoided.

## WARNING

- When measuring the main circuit capacitor capacity (Pr.259 = "1 or 11"), the DC voltage is applied to the motor for about 1 second at power OFF. Never touch the motor terminal, etc. right after powering OFF to prevent an electric shock.

### ◆ Life display of the cooling fan

- If a cooling fan speed of less than the specified speed is detected, Fan alarm "**FN**" (FN) is displayed on the operation panel or the parameter unit. As an alert output, bit 2 of Pr.255 is turned ON (set to 1), and the Y90 signal and Alarm (LF) signal are also output.
- For the terminal used for the LF signal, set "98" (positive logic) or "198" (negative logic) in any of Pr.190 to Pr.196 (Output terminal function selection).

#### NOTE

- When the inverter is mounted with two or more cooling fans, "FN" is displayed even only one of the fans is detected.
- Changing the terminal assignment using Pr.190 to Pr.196 (Output terminal function selection) may affect the other functions. Set parameters after confirming the function of each terminal.
- For replacement of each part, contact the nearest Mitsubishi FA center.

### ◆ Estimated residual life display of the main circuit capacitor (Pr.506) (Standard models and IP55 compatible models)

- Even when the power supply cannot be turned OFF, the remaining life of the main circuit capacitor can be estimated without stopping the operation. Note that the remaining life of the main circuit capacitor estimated by this function is theoretical, and should be used as a guideline only.
- The estimated residual life of the main circuit capacitor is displayed in Pr.506.
- The remaining life of the main circuit capacitor is calculated from the energization time and the inverter output power (100% = Start of service life). When the remaining life of the main circuit capacitor falls below 10%, bit 5 of Pr.255 Life alarm status display turns ON and a warning is output by the Y90 signal.

### ◆ Life display of the relay contacts of terminals A, B, and C (Pr.507, Pr.508)

- The degree of deterioration of the relay contacts of terminals A1, B1, and C1 is displayed in Pr.507, and that for terminals A2, B2, and C2 is displayed in Pr.508.
- The number of times the contacts of relay turn ON is counted down from 100% (0 time) by 1% (500 times). When the counter reaches 10% (45,000 times), bit 6 or bit 7 of Pr.255 turns ON and a warning is output by the Y90 signal.
- Any value can be set in Pr.507 and Pr.508. After replacement of the control circuit terminal block or installation of a control terminal option, set Pr.507 and Pr.508 again.

### ◆ Life display of internal air circulation fans (IP55 compatible models)

- IP55 compatible models are equipped with the internal air circulation fan inside the inverter other than the cooling fan. The internal fan fault "**FN2**" (FN2) appears on the operation panel (FR-DU08) when the rotations per minute is less than 70% of the rated value for the internal air circulation fan. (FN is displayed on the parameter unit (FR-PU07).) As an alarm display, Pr.255 bit 4 is turned ON and also a warning is output to the Y90 signal and Alarm (LF) signal.
- For the terminal used for the LF signal, set "98" (positive logic) or "198" (negative logic) in any of Pr.190 to Pr.196 (Output terminal function selection).

#### NOTE

- Changing the terminal assignment using Pr.190 to Pr.196 (Output terminal function selection) may affect the other functions. Set parameters after confirming the function of each terminal.
- For replacement of each part, contact the nearest Mitsubishi FA center.



## 5.7.20 Maintenance timer alarm

The Maintenance timer (Y95) signal is output when the inverter's cumulative energization time reaches the time period set with the parameter. MT1, MT2 or MT3 is displayed on the operation panel. This can be used as a guideline for the maintenance time of peripheral devices.

Pr.	Name	Initial value	Setting range	Description
503 E710	Maintenance timer 1	0	0 (1 to 9998)	Displays the inverter's cumulative energization time in increments of 100 h (read-only). Writing the setting of "0" clears the cumulative energization time while Pr.503 = "1 to 9998". (Writing is disabled when Pr.503 = "0".)
504 E711	Maintenance timer 1 warning output set time	9999	0 to 9998	Set the time until the Maintenance timer (Y95) signal is output. "MT1" is displayed on the operation panel.
			9999	Without the function
686 E712	Maintenance timer 2	0	0 (1 to 9998)	The same function as Pr.503.
687 E713	Maintenance timer 2 warning output set time	9999	0 to 9998	The same function as Pr.504.
			9999	"MT2" is displayed on the operation panel.
688 E714	Maintenance timer 3	0	0 (1 to 9998)	The same function as Pr.503.
689 E715	Maintenance timer 3 warning output set time	9999	0 to 9998	The same function as Pr.504.
			9999	"MT3" is displayed on the operation panel.

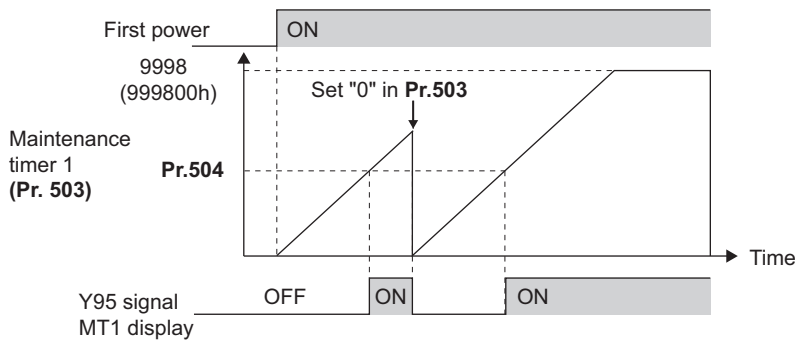

Operation example of the maintenance timer 1 (Pr.503, Pr.504) (with both MT2 and MT3 OFF)

- The cumulative energization time of the inverter is stored in the EEPROM every hour and displayed in Pr.503 (Pr.686, Pr.688) in 100 h increments. Pr.503 (Pr.686, Pr.688) is clamped at 9998 (999800 h).
- When the value in Pr.503 (Pr.686, Pr.688) reaches the time (100 h increments) set in Pr.504 (Pr.687, Pr.689), the Maintenance timer (Y95) signal is output, and also "MT 1" (MT1), "MT 2" (MT2), or "MT 3" (MT3) is displayed on the operation panel.
- For the terminal used for the Y95 signal output, assign the function by setting "95 (positive logic)" or "195 (negative logic)" in any of Pr.190 to Pr.196 (Output terminal function selection).

### NOTE

- The Y95 signal turns ON when any of MT1, MT2 or MT3 is activated. It does not turn OFF unless all of MT1, MT2 and MT3 are cleared.
- If all of MT1, MT2 and MT3 are activated, they are displayed in the priority of "MT1 > MT2 > MT3".
- The cumulative energization time is counted every hour. Energization time of less than 1 h is not counted.
- Changing the terminal assignment using Pr.190 to Pr.196 (Output terminal function selection) may affect the other functions. Set parameters after confirming the function of each terminal.

### Parameters referred to

Pr.190 to Pr.196 (Output terminal function selection) [page 473](#)

## 5.7.21 Current average value monitor signal

The output current average value during constant-speed operation and the maintenance timer value are output to the Current average monitor (Y93) signal as a pulse. The output pulse width can be used in a device such as the I/O unit of a programmable controller as a guideline for the maintenance time for mechanical wear, belt stretching, or deterioration of devices with age.



The pulse is repeatedly output during constant-speed operation in cycles of 20 seconds to the Current average monitor (Y93) signal.

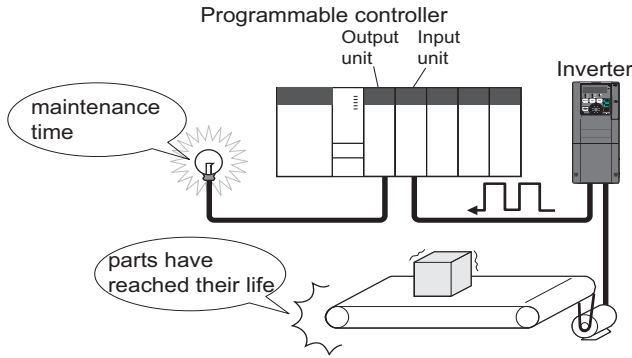

Pr.	Name	Initial value	Setting range	Description
555 E720	Current average time	1 s	0.1 to 1 s	Set the time for calculating the average current during start pulse output (1 second).
556 E721	Data output mask time	0 s	0 to 20 s	Set the time for not obtaining (masking) transitional state data.
557 E722	Current average value monitor signal output reference current	Inverter rated current	0 to 500 A <sup>*1</sup> 0 to 3600 A <sup>*2</sup>	Set the reference (100%) for outputting the output current average value signal.

\*1 For the FR-A820-03160(55K) or lower, and FR-A840-01800(55K) or lower.

\*2 For the FR-A820-03800(75K) or higher, and FR-A840-02160(75K) or higher.

### ◆ Operation example

- The pulse output of the Current average monitor (Y93) signal is indicated below.
- For the terminal used for the Y93 signal output, assign the function by setting "93 (positive logic)" or "193 (negative logic)" in any of **Pr.190 to Pr.194 (Output terminal function selection)**. (This cannot be assigned by setting in **Pr.195 ABC1 terminal function selection** or **Pr.196 ABC2 terminal function selection**.)

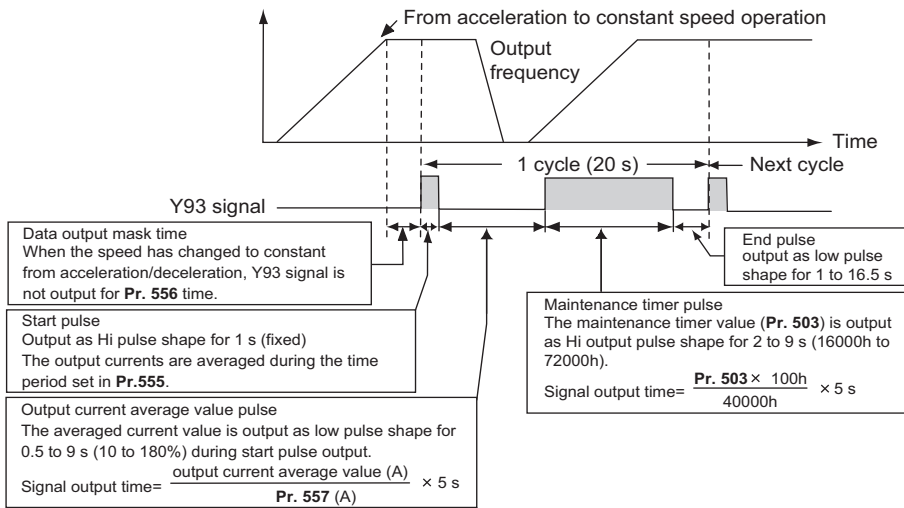

### ◆ Pr.556 Data output mask time setting

- Immediately after acceleration/deceleration is shifted to constant-speed operation, the output current is unstable (transitional state). Set the time for not obtaining (masking) transitional state data in **Pr.556**.

### ◆ Pr.555 Current average time setting

- The output current average is calculated during start pulse (1 second) HIGH output. Set the time for calculating the average current during start pulse output in **Pr.555**.

## ◆ Pr.557 Current average value monitor signal output reference current setting

Set the reference (100%) for outputting the output current average value signal. The signal output time is calculated with the following formula.

$$\frac{\text{Output current average value}}{\text{Pr.557 setting value}} \times 5 \text{ s} \quad (\text{Output current average value } 100\%/5 \text{ s})$$

The output time range is 0.5 to 9 seconds. When the output current average value is less than 10% of the setting value in **Pr.557**, the output time is 0.5 seconds, and when it is more than 180%, the output time is 9 seconds.

For example, when **Pr.557** = 10 A and the output current average value is 15 A:

$15 \text{ A}/10 \text{ A} \times 5 \text{ s} = 7.5 \text{ s}$ , thus the Current average monitor signal maintains LOW output for 7.5 seconds.

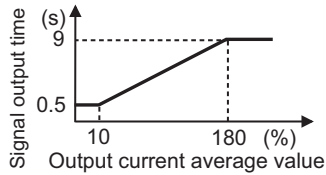

## ◆ Pr.503 Maintenance timer 1 output

After LOW output of the output current value is performed, HIGH output of the maintenance timer value is performed. The maintenance timer value output time is calculated with the following formula.

$$\frac{\text{Pr.503} \times 100}{40000\text{h}} \times 5 \text{ s} \quad (\text{Maintenance timer value } 100\%/5 \text{ s})$$

The output time range is 2 to 9 seconds. When **Pr.503** is less than 16000 hours, the output time is 2 seconds. When it is more than 72000 hours, the output time is 9 seconds.

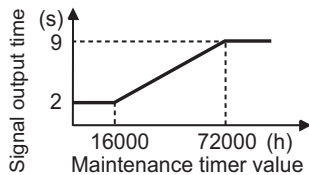

**NOTE**

- Masking of the data output and sampling of the output current are not performed during acceleration/deceleration.
- If constant speed changes to acceleration or deceleration during start pulse output, it is judged as invalid data, and the signal maintains HIGH start pulse output for 3.5 seconds and LOW end pulse output for 16.5 seconds. After the start pulse output is completed, minimum 1-cycle signal output is performed even if acceleration/deceleration is performed.

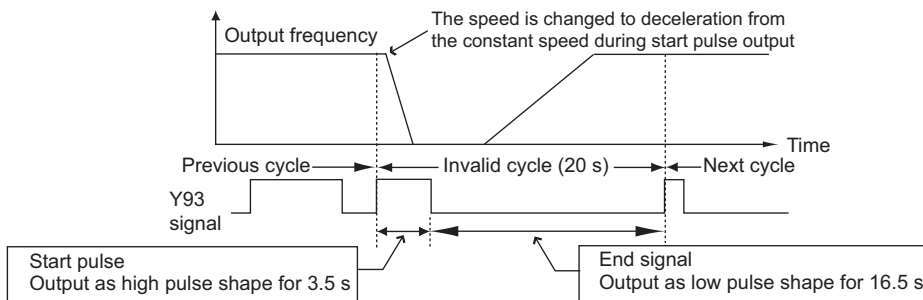

- If the output current value (inverter output current monitor) is 0 A at the completion of the 1-cycle signal output, no signal is output until the next constant-speed state.
- Under the following conditions, the Y93 signal maintains LOW output for 20 seconds (no data output).
  - When acceleration or deceleration is operating at the completion of the 1-cycle signal output
  - When automatic restart after instantaneous power failure (**Pr.57 Restart coasting time** ≠ "9999") is set, and the 1-cycle signal output is completed during the restart operation.
  - When automatic restart after instantaneous power failure (**Pr.57** ≠ "9999") is set, and the restart operation was being performed at the completion of data output masking.
- **Pr.686 Maintenance timer 2** and **Pr.688 Maintenance timer 3** cannot be output.
- Changing the terminal assignment using **Pr.190 to Pr.196 (Output terminal function selection)** may affect the other functions. Set parameters after confirming the function of each terminal.

**Parameters referred to**

**Pr.57 Restart coasting time** [page 628](#), [page 635](#)

**Pr.190 to Pr.196 (Output terminal function selection)** [page 473](#)

**Pr.503 Maintenance timer 1**, **Pr.686 Maintenance timer 2**, **Pr.688 Maintenance timer 3** [page 363](#)

## 5.8 (F) Setting of acceleration/deceleration time and acceleration/deceleration pattern

Purpose	Parameter to set			Refer to page
To set the motor acceleration/deceleration time	Acceleration/deceleration time	P.F000 to P.F003, P.F010, P.F011, P.F020 to P.F022, P.F030, P.F031, P.F040, P.F070, P.F071, P.G264	Pr.7, Pr.8, Pr.16, Pr.20, Pr.21, Pr.44, Pr.45, Pr.110, Pr.111, Pr.147, Pr.611, Pr.791, Pr.792, Pr.1103, Pr.1349	367
To set the acceleration/deceleration pattern suitable for an application	Acceleration/deceleration pattern and backlash measures	P.F100, P.F200 to P.F203, P.F300 to P.F303, P.F400 to P.F403	Pr.29, Pr.140 to Pr.143, Pr.380 to Pr.383, Pr.516 to Pr.519	372
To command smooth speed transition with terminals	Remote setting function	P.F101	Pr.59	377
To set the starting frequency	Starting frequency and start-time hold	P.F102, P.F103	Pr.13, Pr.571	381, 382
To set optimum acceleration/deceleration time automatically	Automatic acceleration/deceleration	P.F500, P.F510 to P.F513	Pr.61 to Pr.63, Pr.292	384
To set V/F pattern for lift automatically	Lift operation (Automatic acceleration/deceleration)	P.F500 to P.F510, P.F520	Pr.61 to Pr.64, Pr.292	387

### 5.8.1 Setting the acceleration and deceleration time

The following parameters are used to set motor acceleration/deceleration time.

Set a larger value for a slower acceleration/deceleration, or a smaller value for a faster acceleration/deceleration.

For the acceleration time at automatic restart after instantaneous power failure, refer to **Pr.611 Acceleration time at a restart** (page 628, page 635).

Pr.	Name	Initial value		Setting range	Description	
		FM	CA			
20 F000	Acceleration/ deceleration reference frequency	60 Hz	50 Hz	1 to 590 Hz	Set the frequency that is the basis of acceleration/deceleration time. As acceleration/deceleration time, set the time required to change the frequency from a stop status (0 Hz) to the frequency set in <b>Pr.20</b> and vice versa.	
21 F001	Acceleration/ deceleration time increments	0		0	Increment: 0.1 s	Select the increment for the acceleration/ deceleration time setting.
				1	Increment: 0.01 s	
16 F002	Jog acceleration/ deceleration time	0.5 s		0 to 3600 s	Set the acceleration/deceleration time for JOG operation (from stop status to <b>Pr.20</b> ). Refer to page 410.	
611 F003	Acceleration time at a restart	9999		0 to 3600 s	Set the acceleration time for restart (from stop status to <b>Pr.20</b> ).	
				9999	Standard acceleration time (for example, <b>Pr.7</b> ) is applied as the acceleration time at restart. Refer to page 628, page 635.	
7 F010	Acceleration time	5s <sup>*1</sup>		0 to 3600 s	Set the motor acceleration time (time required to change the frequency from a stop status (0 Hz) to the frequency set in <b>Pr.20</b> ).	
		15s <sup>*2</sup>				
8 F011	Deceleration time	5s <sup>*1</sup>		0 to 3600 s	Set the motor deceleration time (from <b>Pr.20</b> to stop status).	
		15s <sup>*2</sup>				
44 F020	Second acceleration/ deceleration time	5 s		0 to 3600 s	Set the acceleration/deceleration time used while the RT signal is ON.	
45 F021	Second deceleration time	9999		0 to 3600 s	Set the deceleration time used while the RT signal is ON.	
				9999	The acceleration time applies to the deceleration time.	
147 F022	Acceleration/ deceleration time switching frequency	9999		0 to 590 Hz	Set the frequency where the acceleration/deceleration time switches to the time set in <b>Pr.44</b> and <b>Pr.45</b> .	
				9999	Function disabled.	
110 F030	Third acceleration/ deceleration time	9999		0 to 3600 s	Set the acceleration/deceleration time when the X9 signal is ON.	
				9999	Third acceleration/deceleration is disabled.	
111 F031	Third deceleration time	9999		0 to 3600 s	Set the deceleration time when the X9 signal is ON.	
				9999	The acceleration time applies to the deceleration time.	
791 F070	Acceleration time in low-speed range	9999		0 to 3600 s	Set the acceleration time in a low-speed range (less than 1/10 of the rated motor frequency).	
				9999	The acceleration time set in <b>Pr.7</b> is applied. (While the RT signal or the X9 signal is ON, the second or third function is enabled.)	
792 F071	Deceleration time in low-speed range	9999		0 to 3600 s	Set the deceleration time in a low-speed range (less than 1/10 of the rated motor frequency).	
				9999	The deceleration time set in <b>Pr.8</b> is applied. (While the RT signal or the X9 signal is ON, the second or third function is enabled.)	
1103 F040	Deceleration time at emergency stop	5 s		0 to 3600 s	Set the motor deceleration time at a deceleration by turning ON the X92 signal.	
1349 G264	Emergency stop operation selection	0		0	Droop control enabled.	Speed loop integration enabled.
				1	Droop control enabled.	Speed loop integration disabled.
				10	Droop control disabled.	Speed loop integration enabled.
				11	Droop control disabled.	Speed loop integration disabled.

\*1 The initial value for the FR-A820-00490(7.5K) or lower and FR-A840-00250(7.5K) or lower.

\*2 Initial value for the FR-A820-00630(11K) or higher and FR-A840-00310(11K) and higher.

## ◆ Control block diagram

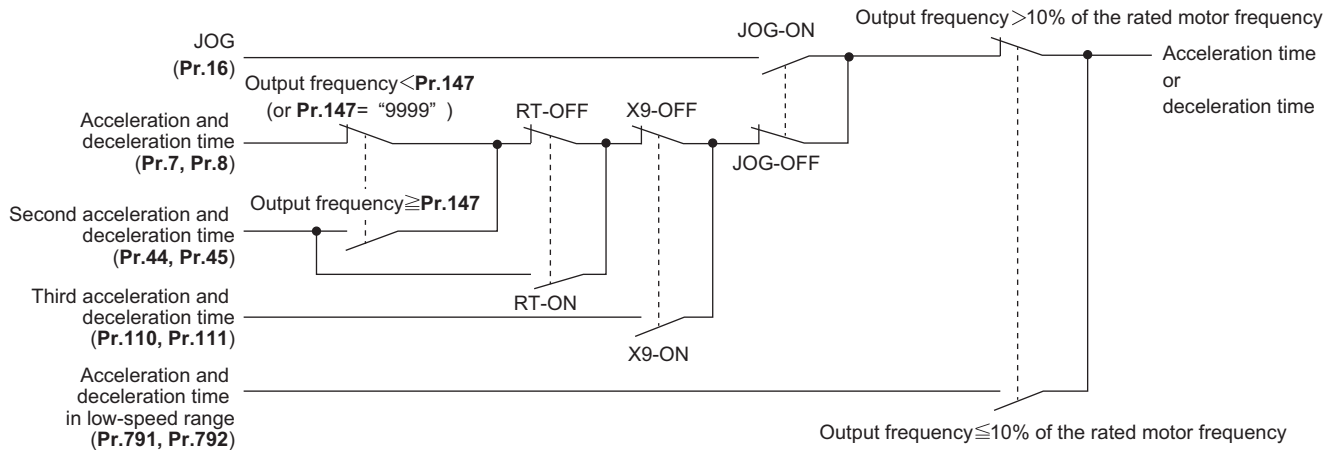

## ◆ Acceleration time setting (Pr.7, Pr.20)

- Use **Pr.7 Acceleration time** to set the acceleration time required to change the frequency to the frequency set in **Pr.20 Acceleration/deceleration reference frequency** from stop status.
- Set the acceleration time according to the following formula.

$$\text{Acceleration time setting} = \text{Pr.20 setting} \times (\text{Acceleration time to change the frequency from stop status to maximum frequency}) / (\text{Maximum frequency} - \text{Pr.13 setting})$$

- For example, the following calculation is performed to find the setting value for **Pr.7** when increasing the output frequency to the maximum frequency of 50 Hz in 10 seconds with **Pr.20 = 60 Hz** (initial value) and **Pr.13 = 0.5 Hz**.

$$\text{Pr.7 setting} = 60 \text{ Hz} \times 10 \text{ s} / (50 \text{ Hz} - 0.5 \text{ Hz}) \approx 12.1 \text{ s}$$

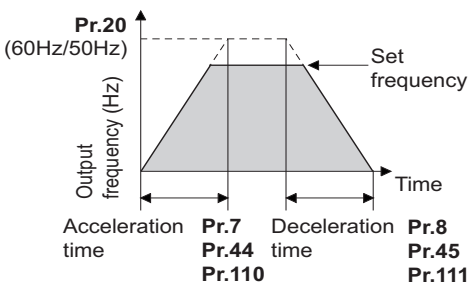

## ◆ Deceleration time setting (Pr.8, Pr.20)

- Use **Pr.8 Deceleration time** to set the deceleration time required to change the frequency to a stop status from the frequency set in **Pr.20 Acceleration/deceleration reference frequency**.
- Set the deceleration time according to the following formula.

$$\text{Deceleration time setting} = \text{Pr.20 setting} \times (\text{Deceleration time to change the frequency from maximum frequency to stop status}) / (\text{Maximum frequency} - \text{Pr.10 setting})$$

- For example, the following calculation is used to find the setting value for **Pr.8** when decreasing the output frequency from the maximum frequency of 50 Hz in 10 seconds with **Pr.20 = 120 Hz** and **Pr.10 = 3 Hz**.

$$\text{Pr.8 setting} = 120 \text{ Hz} \times 10 \text{ s} / (50 \text{ Hz} - 3 \text{ Hz}) \approx 25.5 \text{ s}$$

### NOTE

- If the acceleration/deceleration time is set, the actual motor acceleration/deceleration time cannot be made shorter than the shortest acceleration/deceleration time determined by the mechanical system J (moment of inertia) and motor torque.
- If the **Pr.20** setting is changed, the **Pr.125** and **Pr.126** (frequency setting signal gain frequency) settings do not change. Set **Pr.125** and **Pr.126** to adjust the gains.
- Under PM sensorless vector control, if the protective function (E.OLT) is activated due to insufficient torque in the low-speed range, set longer acceleration/deceleration times only in the low-speed range in **Pr.791 Acceleration time in low-speed range** and **Pr.792 Deceleration time in low-speed range**.

## ◆ Changing the minimum increment of the acceleration/deceleration time (Pr.21)

- Use **Pr.21** to set the minimum increment of the acceleration/deceleration time.  
Setting value "0" (initial value): minimum increment 0.1 s  
Setting value "1": minimum increment 0.01 s
- Pr.21** setting allows the minimum increment of the following parameters to be changed.  
**Pr.7, Pr.8, Pr.16, Pr.44, Pr.45, Pr.110, Pr.111, Pr.264, Pr.265, Pr.791, Pr.792, Pr.1103**

### NOTE

- Pr.21** setting does not affect the minimum increment setting of **Pr.611 Acceleration time at a restart**.
- The FR-DU08 and the FR-PU07 provide a five-digit readout (including the number of decimal places) on a value of parameters. Therefore, a value of "1000" or larger is set/displayed only in increments of 0.1 second even if **Pr.21** = "1".

## ◆ Setting multiple acceleration/deceleration times (RT signal, X9 signal, Pr.44, Pr.45, Pr.110, Pr.111, Pr.147)

- Pr.44 and Pr.45** are valid when the RT signal is ON or when the output frequency is equal to or higher than the frequency set in **Pr.147 Acceleration/deceleration time switching frequency**. **Pr.110 and Pr.111** are valid when the X9 signal is ON.
- Even at the frequency lower than the **Pr.147** setting, turning ON the RT signal (X9 signal) switches the acceleration/deceleration time to the second (third) acceleration/deceleration time. The priority of the signals and settings is X9 signal > RT signal > **Pr.147** setting.
- To input the X9 signal, set "9" in any of **Pr.178 to Pr.189 (Input terminal function selection)** to assign the function to the terminal.
- When "9999" is set in **Pr.45 and Pr.111**, the deceleration time becomes equal to the acceleration time (**Pr.44, Pr.110**).
- When **Pr.110** = "9999" is set, the third acceleration/deceleration function is disabled.
- If the **Pr.147** setting is equal to or less than the **Pr.10 DC injection brake operation frequency** or the **Pr.13 Starting frequency** setting, the acceleration/deceleration time switches to the **Pr.44 (Pr.45)** when the output frequency reaches or exceeds the **Pr.10 or Pr.13** setting.

Pr.147 setting	Acceleration/deceleration time	Description
9999 (initial value)	<b>Pr.7, Pr.8</b>	Acceleration/deceleration time is not automatically changed.
0.00 Hz	<b>Pr.44, Pr.45</b>	Second acceleration/deceleration time is applied from the start.
$0.01 \text{ Hz} \leq \text{Pr.147} \leq \text{Set frequency}$	Output frequency < <b>Pr.147</b> : <b>Pr.7, Pr.8</b> <b>Pr.147</b> ≤ Output frequency: <b>Pr.44, Pr.45</b>	Acceleration/deceleration time is automatically changed.
Set frequency < <b>Pr.147</b>	<b>Pr.7, Pr.8</b>	Not changed as the frequency has not reached the switchover frequency.

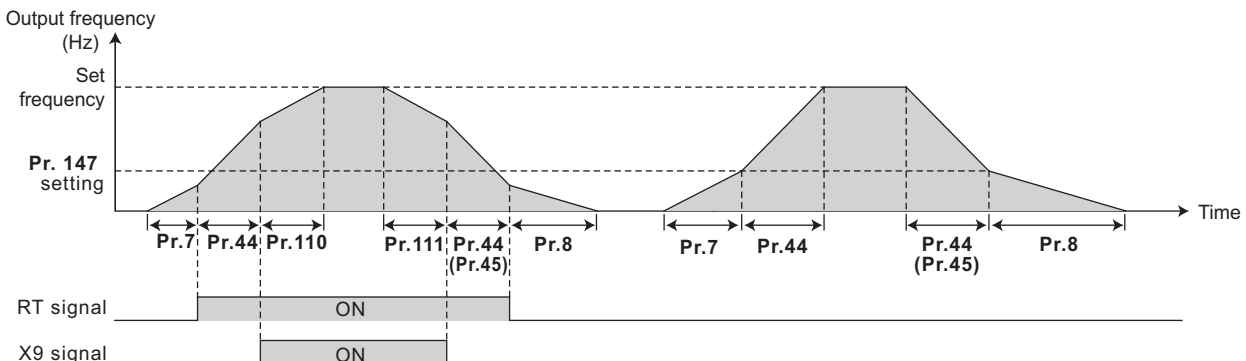

**NOTE**

- The reference frequency during acceleration/deceleration depends on the **Pr.29 Acceleration/deceleration pattern selection** setting. (Refer to [page 372](#).)
- The RT and X9 signals can be assigned to an input terminal by setting **Pr.178 to Pr.189 (Input terminal function selection)**. Changing the terminal assignment may affect other functions. Set parameters after confirming the function of each terminal.
- The RT (X9) signal acts as the second (third) function selection signal and makes the other second (third) functions valid. (Refer to [page 525](#).)
- The RT signal is assigned to terminal RT in the initial status. Set "3" in one of **Pr.178 to Pr.189 (Input terminal function selection)** to assign the RT signal to another terminal.

**◆ Setting the acceleration/deceleration time in the low-speed range (Pr.791, Pr.792)**

- If torque is required in the low-speed range (less than 10% of the rated motor frequency) under PM sensorless vector control, set the **Pr.791 Acceleration time in the low-speed range** and **Pr.792 Deceleration time in low-speed range** settings higher than the **Pr.7 Acceleration time** and **Pr.8 Deceleration time** settings so that the mild acceleration/deceleration is performed in the low-speed range. Such a setting is especially effective when the low-speed range high-torque characteristic is disabled (**Pr.788 = "0"**). (When RT signal or X9 signal is turned ON, the second or third acceleration/deceleration time setting is prioritized.)

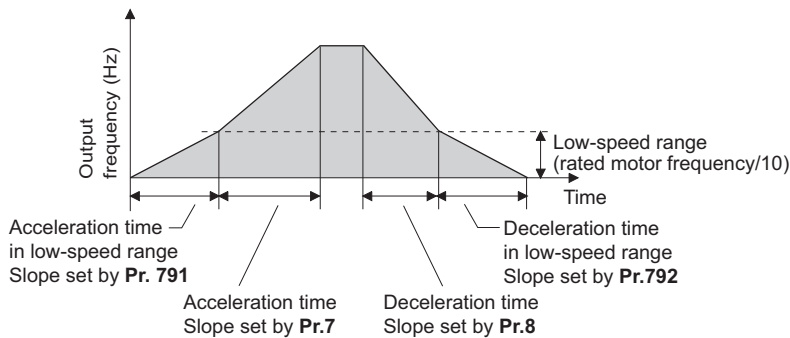

**NOTE**

- Set **Pr.791 (Pr.792)** to a value larger than the **Pr.7 (Pr.8)** setting. If set as **Pr.791 < Pr.7**, the operation is performed as **Pr.791 = Pr.7**. If set as **Pr.792 < Pr.8**, the operation is performed as **Pr.792 = Pr.8**.
- Refer to [page 833](#) for the rated motor frequency of MM-CF.

**◆ Emergency stop function (Pr.1103)**

- When the Emergency stop (X92) signal is ON, the deceleration stop is performed according to the settings in the **Pr.1103 Deceleration time at emergency stop** and **Pr.815 Torque limit level 2**.
- To input the X92 signal, set "92" in any of **Pr.178 to Pr.189 (Input terminal function selection)** to assign the function to a terminal.
- The X92 signal is a normally closed input (NC contact input).
- "PS" is displayed on the operation panel during activation of the emergency stop function.

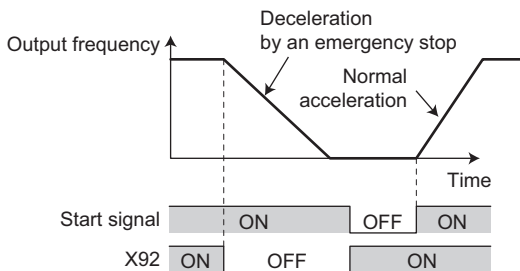



- The droop control and the speed loop integration at the emergency stop by the Emergency stop (X92) signal can be enabled/disabled using **Pr.1349 Emergency stop operation selection**.

Pr.1349 setting	Description	
	Droop control	Speed loop integration
0	Enabled	Enabled
1	Enabled	Disabled
10	Disabled	Enabled
11	Disabled	Disabled

## NOTE

- The X92 signals can be assigned to an input terminal by setting **Pr.178 to Pr.189 (Input terminal function selection)**. Changing the terminal assignment may affect other functions. Set parameters after confirming the function of each terminal.
- Refer to [page 738](#) for details on the droop control.
- Refer to [page 254](#) for details on the speed loop integration.

## Parameters referred to

Pr.3 Base frequency [page 707](#)

Pr.10 DC injection brake operation frequency [page 715](#)

Pr.29 Acceleration/deceleration pattern selection [page 372](#)

Pr.125, Pr.126 (frequency setting gain frequency) [page 505](#)

Pr.178 to Pr.189 (Input terminal function selection) [page 521](#)

Pr.264 Power-failure deceleration time 1, Pr.265 Power-failure deceleration time 2 [page 505](#)

## 5.8.2 Acceleration/deceleration pattern

The acceleration/deceleration pattern can be set according to the application. In addition, the backlash measures that stop acceleration/deceleration by the frequency or time set with parameters at acceleration/deceleration can be set.

Pr.	Name	Initial value	Setting range	Description
29 F100	Acceleration/deceleration pattern selection	0	0	Linear acceleration/deceleration
			1	S-pattern acceleration/deceleration A
			2	S-pattern acceleration/deceleration B
			3	Backlash measure
			4	S-pattern acceleration/deceleration C
			5	S-pattern acceleration/deceleration D
6	Variable-torque acceleration/deceleration			
140 F200	Backlash acceleration stopping frequency	1 Hz	0 to 590 Hz	Set the stopping frequency and time during backlash measures. Valid by backlash measures ( <b>Pr.29</b> = "3").
141 F201	Backlash acceleration stopping time	0.5 s	0 to 360 s	
142 F202	Backlash deceleration stopping frequency	1 Hz	0 to 590 Hz	
143 F203	Backlash deceleration stopping time	0.5 s	0 to 360 s	
380 F300	Acceleration S-pattern 1	0	0 to 50%	Set the time for drawing the S-pattern from acceleration/ deceleration start to linear acceleration as a ratio (%) of acceleration/deceleration time ( <b>Pr.7, 8</b> , etc.). The acceleration/deceleration curve can be switched by the X20 signal. Valid by S-pattern acceleration/deceleration C ( <b>Pr.29</b> = "4").
381 F301	Deceleration S-pattern 1	0	0 to 50%	
382 F302	Acceleration S-pattern 2	0	0 to 50%	
383 F303	Deceleration S-pattern 2	0	0 to 50%	
516 F400	S-pattern time at a start of acceleration	0.1 s	0.1 to 2.5 s	Set the time required for acceleration (S-pattern) of S-pattern acceleration/deceleration. Valid by S-pattern acceleration/deceleration D ( <b>Pr.29</b> = "5").
517 F401	S-pattern time at a completion of acceleration	0.1 s	0.1 to 2.5 s	
518 F402	S-pattern time at a start of deceleration	0.1 s	0.1 to 2.5 s	
519 F403	S-pattern time at a completion of deceleration	0.1 s	0.1 to 2.5 s	

## ◆ Linear acceleration/deceleration (Pr.29 = "0 (initial value)")

- When the frequency is changed for acceleration, deceleration, etc. during inverter operation, the output frequency is changed linearly (linear acceleration/deceleration) to reach the set frequency without straining the motor and inverter. Linear acceleration/deceleration has a uniform frequency/time slope.

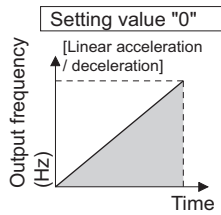

## ◆ S-pattern acceleration/deceleration A (Pr.29 = "1")

- Use this when acceleration/deceleration is required for a short time until a high-speed area equal to or higher than the base frequency, such as for the main shaft of the machine.
- The acceleration/deceleration pattern has the **Pr.3 Base frequency (Pr.84 Rated motor frequency** under PM motor control) (fb) as the point of inflection in an S-pattern curve, and the acceleration/deceleration time can be set to be suitable for the motor torque reduction in the constant-power operation range at the base frequency (fb) or more.

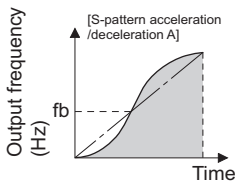

- Acceleration/deceleration time calculation method when the set frequency is equal to or higher than the base frequency

$$\text{Acceleration time } t = (4/9) \times (T/fb^2) \times f^2 + (5/9) \times T$$

Where T is the acceleration/deceleration time (s), f is the set frequency (Hz), and fb is the base frequency (rated motor frequency)

- Reference (0 Hz to set frequency) of acceleration/deceleration time when **Pr.3 = 60 Hz**

Acceleration/deceleration time (s)	Set frequency (Hz)			
	60	120	200	400
5	5	12	27	102
15	15	35	82	305

### NOTE

- For the acceleration/deceleration time setting of the S-pattern acceleration/deceleration A, set the time to **Pr.3 (Pr.84** under PM sensorless vector control) instead of **Pr.20 Acceleration/deceleration reference frequency**.

## ◆ S-pattern acceleration/deceleration B (Pr.29 = "2")

- This is useful for preventing collapsing stacks such as on a conveyor. S-pattern acceleration/deceleration B can reduce the impact during acceleration/deceleration by accelerating/decelerating while maintaining an S-pattern from the present frequency (f2) to the target frequency (f1).

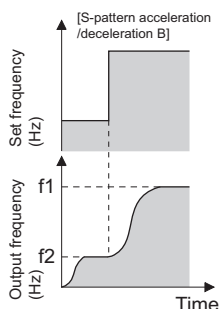

**NOTE**

- When the RT or X9 signal turns ON during acceleration or deceleration with the S-pattern acceleration/deceleration B enabled, a pattern of acceleration or deceleration changes to linear at the moment.

**◆ Backlash measures (Pr.29 = "3", Pr.140 to Pr.143)**

- Reduction gears have an engagement gap and have a dead zone between forward rotation and reverse rotation. This dead zone is called backlash, and this gap disables a mechanical system from following motor rotation. More specifically, a motor shaft develops excessive torque when the direction of rotation changes or when constant-speed operation shifts to deceleration, resulting in a sudden motor current increase or regenerative status.
- To avoid backlash, acceleration/deceleration is temporarily stopped. Set the acceleration/deceleration stopping frequency and time in **Pr.140 to Pr.143**.

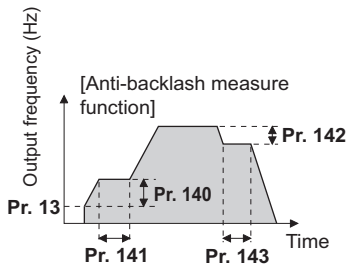

**NOTE**

- Setting the backlash measures increases the acceleration/deceleration time by the stopping time.

**◆ S-pattern acceleration/deceleration C (Pr.29 = "4", Pr.380 to Pr.383)**

- Switch the acceleration/deceleration curve by the S-pattern acceleration/deceleration C switchover (X20) signal.
- To input the X20 signal, set "20" in any of Pr.178 to Pr.189 (Input terminal function selection) to assign the function to the terminal.

X20 signal	During acceleration	During deceleration
OFF	Pr.380 Acceleration S-pattern 1	Pr.381 Deceleration S-pattern 1
ON	Pr.382 Acceleration S-pattern 2	Pr.383 Deceleration S-pattern 2

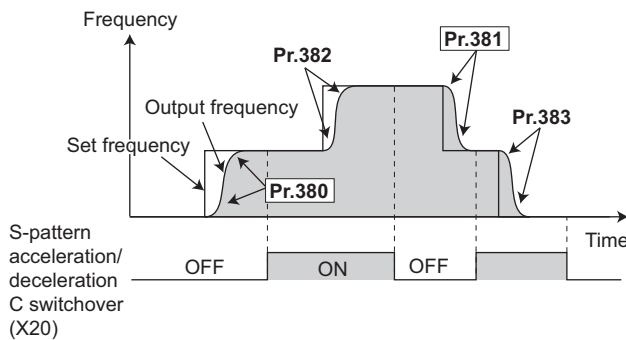

- Set the ratio (%) of time for drawing an S-shape in **Pr.380 to Pr.383** with the acceleration time as 100%.

Parameter setting (%) =  $T_s / T \times 100\%$

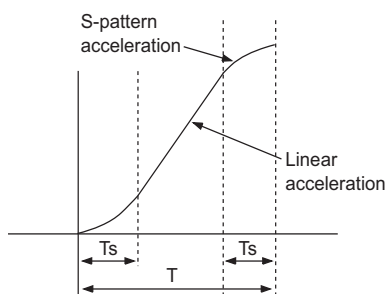

**NOTE**

- At a start, the motor starts at **Pr.13 Starting frequency** when the start signal turns ON.
- If there is a difference between the speed command and speed at a start of deceleration due to torque limit operation etc., the speed command is matched with the speed to make deceleration.
- Change the X20 signal after the speed becomes constant. S pattern operation before switching continues even if the X20 signal is changed during acceleration or deceleration.
- The X20 signal can be assigned to an input terminal by setting any of **Pr.178 to Pr.189 (Input terminal function selection)**. Changing the terminal assignment may affect other functions. Set parameters after confirming the function of each terminal.
- When the RT or X9 signal turns ON during acceleration or deceleration with the S-pattern acceleration/deceleration C enabled, a pattern of acceleration or deceleration changes to linear at the moment.

### ◆ S-pattern acceleration/deceleration D (Pr.29 = "5", Pr.516 to Pr.519)

- Set the time required for S-pattern operation part of S-pattern acceleration/deceleration with **Pr.516 to Pr.519**. Set each S-pattern operation time for acceleration start (**Pr.516**), acceleration completion (**Pr.517**), deceleration start (**Pr.518**), and deceleration completion (**Pr.519**).
- When S-pattern acceleration/deceleration D is set, the acceleration/deceleration time becomes longer, as shown below. The set acceleration/deceleration time T1 indicates the actual time taken for linear acceleration/deceleration as calculated based on **Pr.7, Pr.8, Pr.44, Pr.45, Pr.110, and Pr.111**.

**5**

Actual acceleration time T2 = set acceleration time T1 + (S-pattern time at start of acceleration + S-pattern time at completion of acceleration) / 2  
 Actual deceleration time T2 = set deceleration time T1 + (S-pattern time at start of deceleration + S-pattern time at completion of deceleration) / 2

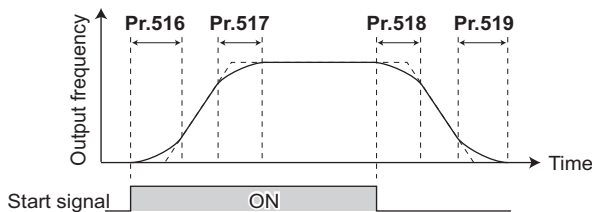
**NOTE**

- Even if the start signal is turned OFF during acceleration, the inverter does not decelerate immediately to avoid sudden frequency change. (Likewise, the inverter does not immediately accelerate when deceleration is changed to re-acceleration by turning the start signal ON during deceleration, etc.)

- For example, the following table shows the actual acceleration time when starting the inverter by selecting S-pattern acceleration/deceleration D from a stop to 60 Hz, as shown below, with the initial parameter settings.

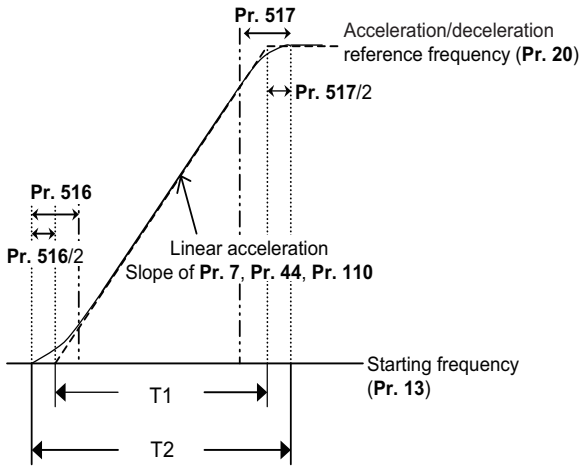

$$\begin{aligned} \text{Set acceleration time } T1 &= (\text{set frequency} - \text{Pr.13}) \times \text{Pr.7} / \text{Pr.20} \\ &= (60 \text{ Hz} - 0.5 \text{ Hz}) \times 5 \text{ s} / 60 \text{ Hz} \\ &\doteq 4.96 \text{ s (actual acceleration time at linear acceleration)} \\ \text{Actual acceleration time } T2 &= \text{set acceleration time } T1 + (\text{Pr.516} + \text{Pr.517}) / 2 \\ &= 4.96 \text{ s} + (0.1 \text{ s} + 0.1 \text{ s}) / 2 \\ &= 5.06 \text{ s (acceleration time at S-pattern acceleration)} \end{aligned}$$

- The following table shows the actual deceleration time when stopping the inverter by selecting S-pattern acceleration/deceleration D from operation to 0 Hz, as shown below, with the initial parameter settings.

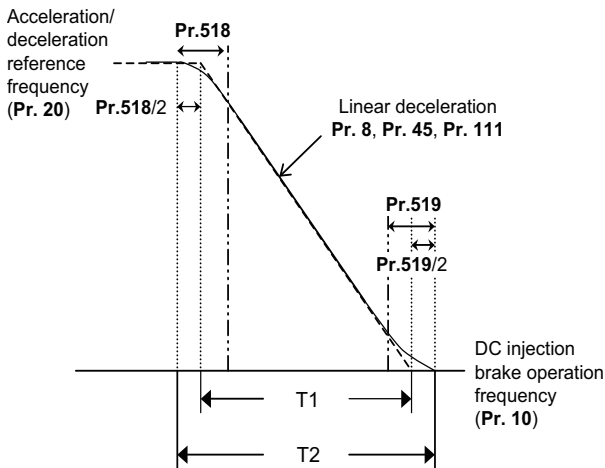

$$\begin{aligned} \text{Set deceleration time } T1 &= (\text{set frequency} - \text{Pr.10 DC injection brake operation frequency}) \times \text{Pr.8} / \text{Pr.20} \\ &= (60 \text{ Hz} - 3 \text{ Hz}) \times 5 \text{ s} / 60 \text{ Hz} \\ &\doteq 4.75 \text{ s (actual deceleration time at linear deceleration)} \\ \text{Actual deceleration time } T2 &= \text{set deceleration time } T1 + (\text{Pr.518} + \text{Pr.519}) / 2 \\ &= 4.75 \text{ s} + (0.1 \text{ s} + 0.1 \text{ s}) / 2 \\ &= 4.85 \text{ s (deceleration time at S-pattern deceleration)} \end{aligned}$$

### NOTE

- When acceleration/deceleration time (such as **Pr.7** and **Pr.8**) is set to "0 s" under Real sensorless vector control, Vector control, and PM sensorless vector control (with MM-CF and **Pr.788 Low speed range torque characteristic selection** = "9999 (initial value)"), linear acceleration and deceleration are performed for the S-pattern acceleration/deceleration A to D and backlash measures (**Pr.29** = "1 to 5").
- Set linear acceleration/deceleration (**Pr.29** = "0 (initial setting)") when torque control is performed under Real sensorless vector control or Vector control. When acceleration/deceleration patterns other than the linear acceleration/deceleration are selected, the protective function of the inverter may be activated.

## ◆ Variable-torque acceleration/deceleration (Pr.29 = "6")

- This function is useful for variable-torque load such as a fan and blower to accelerate/decelerate in short time. Linear acceleration/deceleration is performed in the area where the output frequency > base frequency.

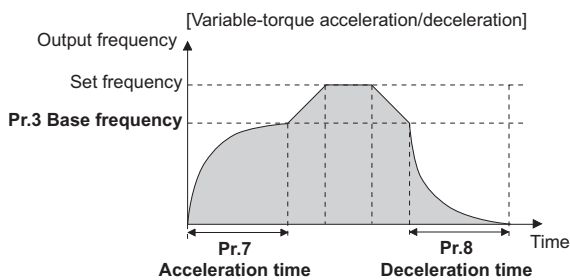

### NOTE

- When the base frequency is out of the range 45 to 65 Hz, the linear acceleration/deceleration is performed even if Pr.29 = "6".
- Even if Pr.14 Load pattern selection = "1 (variable torque load)", variable torque acceleration/deceleration setting is prioritized and the inverter operates as Pr.14 = "0 (constant torque load)".
- For the variable torque acceleration/deceleration time setting, set the time period to reach Pr.3 Base frequency. (Not the time period to reach Pr.20 Acceleration/deceleration reference frequency.)
- The variable torque acceleration/deceleration is disabled during PM sensorless vector control. (Linear acceleration/deceleration is performed.)

### Parameters referred to

Pr.3 Base frequency [page 707](#)

Pr.7 Acceleration time, Pr.8 Deceleration time, Pr.20 Acceleration/deceleration reference frequency [page 367](#)

Pr.10 DC injection brake operation frequency [page 715](#)

Pr.14 Load pattern selection [page 708](#)

Pr.178 to Pr.189 (Input terminal function selection) [page 521](#)

## 5.8.3 Remote setting function

Even if the operation panel is located away from the enclosure, contact signals can be used to perform continuous variable-speed operation, without using analog signals.

Pr.	Name	Initial value	Setting range	Description		
				RH, RM, RL signal function	Frequency setting storage	Deceleration to the main speed or lower
59 F101	Remote function selection	0	0	Multi-speed setting	—	Not available
			1	Remote setting	Enabled	
			2	Remote setting	Disabled	
			3	Remote setting	Disabled (Turning OFF the STF/STR signal clears the remotely-set frequency.)	
			11	Remote setting	Enabled	Available
			12	Remote setting	Disabled	
			13	Remote setting	Disabled (Turning OFF the STF/STR signal clears the remotely-set frequency.)	

## ◆ Remote setting function

- When Pr.59 ≠ "0" (remote setting enabled), the functions of the signals are as shown in the following table.

Signal name	Function	Description
STF/STR	Forward/Reverse	The inverter accelerates the motor in the forward or reverse direction up to the main speed or to the frequency stored by the remote setting function.
RH	Acceleration	The set frequency increases according to the Pr.44 setting.
RM	Deceleration	The set frequency decreases according to the Pr.45 setting.
RL	Clear	The set frequency is cleared and the main speed is applied.
Terminal 2 (analog signal)	Main speed	The setting of the main speed is used as a base. The main speed is increased by the RH signal and decreased by the RM signal.

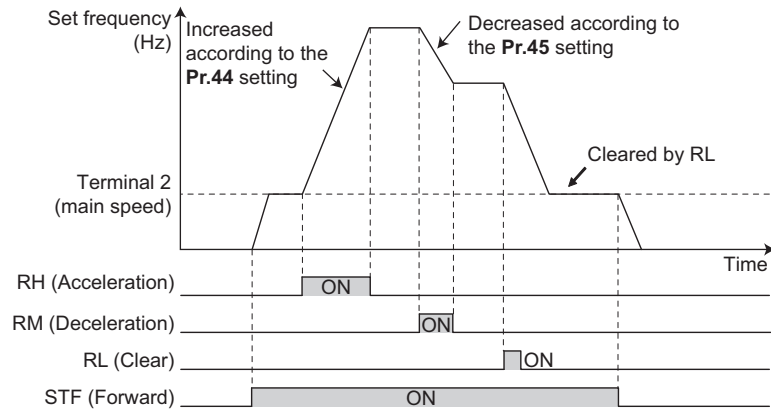
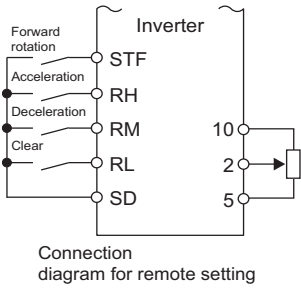

## ◆ Main speed

- The main speed used in the remote setting corresponds with each of the following operation modes.

Operation mode	Main speed
PU operation mode / NET operation mode	Digital setting
External operation mode / PU/External combined operation mode 2 (Pr.79 = "4")	Analog input <sup>*1</sup>
PU/External combined operation mode 1 (Pr.79 = "3")	Analog input via terminal 4 (AU signal ON) <sup>*1</sup>

\*1 Set Pr.28 Multi-speed input compensation selection to "1" when enabling compensation for input via terminal 1.

## ◆ Acceleration/deceleration operation

- The output frequency changes as follows when the set frequency is changed by the remote setting function.

Frequency	Time setting	Description
Set frequency	Pr.44/Pr.45	The set frequency increases/decreases by remote setting according to the Pr.44/Pr.45 setting.
Output frequency	Pr.7/Pr.8	The output frequency increases/decreases by the set frequency according to the Pr.7/Pr.8 setting.

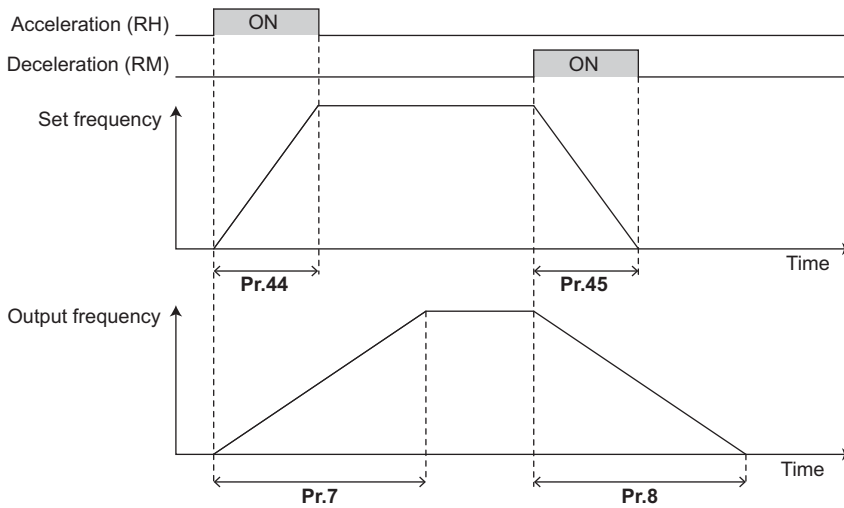

### NOTE

- If the time setting of the output frequency is longer than the time setting of the set frequency, the motor accelerates/decelerates according to the time setting of the output frequency.

- Deceleration to the main speed or lower

By setting **Pr.59** = "11 to 13", the speed can be decelerated to the frequency lower than the main speed (set by the External operation frequency (except multi-speed setting) or PU operation frequency).

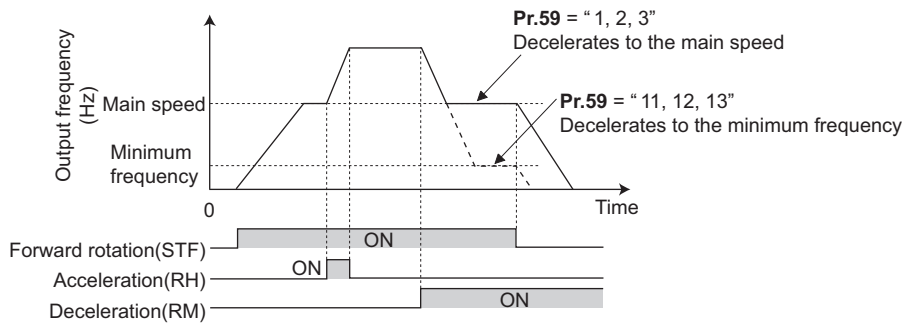

- Regardless of whether the remote setting is enabled or disabled, the acceleration/deceleration time set for the output frequency can be changed to the second or third acceleration/deceleration time by turning ON the RT or X9 signal.
- The acceleration/deceleration time setting of the set frequency is fixed at the **Pr.44/Pr.45** setting.

### ◆ Frequency setting storage

- The remotely set frequency is stored, held, or cleared according to the **Pr.59** setting. When the inverter is turned ON again and the operation is resumed, the setting shown in the parentheses will be applied.

Pr.59 setting	Power OFF	STF/STR signal OFF
1, 11	Stored (stored frequency)	Held (stored frequency)
2, 12	Cleared (main speed)	Held (stored frequency)
3, 13	Clear (main speed)	Cleared (main speed)

- Storage conditions

The remotely-set frequency is stored at the point when the start signal (STF or STR) turns OFF. The remotely-set frequency is stored every minute after turning OFF (ON) the RH and RM signals together. Every minute, the frequency is overwritten in the EEPROM if the latest frequency is different from the previous one when comparing the two. This cannot be written using the RL signal.



## NOTE

- When switching the start signal from ON to OFF, or changing frequency by the RH or RM signal frequently, set the frequency setting value storage function (write to EEPROM) invalid (**Pr.59** = "2, 3, 12, 13"). If the frequency setting value storage function is valid (**Pr.59** = "1, 11"), the frequency is written to EEPROM frequently, and this will shorten the life of the EEPROM.
- The range of frequency changeable using the acceleration (RH) signal and the deceleration (RM) signal is 0 to the maximum frequency (set in **Pr.1** or **Pr.18**). Note that the maximum value of set frequency is equal to the total of the main speed and the maximum frequency.

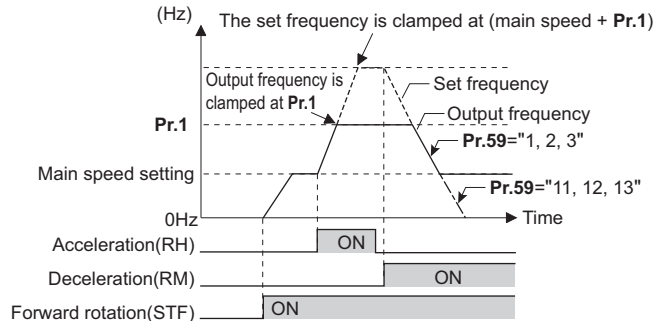

- Even if the start signal (STF or STR) is OFF, turning ON the RH or RM signal varies the preset frequency.
- The RH, RM, or RL signal can be assigned to an input terminal by setting **Pr.178 to Pr.189 (Input terminal function selection)**. Changing the terminal assignment may affect other functions. Set parameters after confirming the function of each terminal.
- The inverter can be used in the Network operation mode.
- The remote setting function is invalid during JOG operation and PID control operation.
- The multi-speed operation function is invalid when remote setting function is selected.

### When the setting frequency is "0"

- Even when the remotely-set frequency is cleared by turning ON the clear (RL) signal after turning OFF (ON) both the RH and RM signals, the inverter operates at the remotely-set frequency stored in the last operation if power is reapplied before one minute has elapsed since turning OFF (ON) both the RH and RM signals.

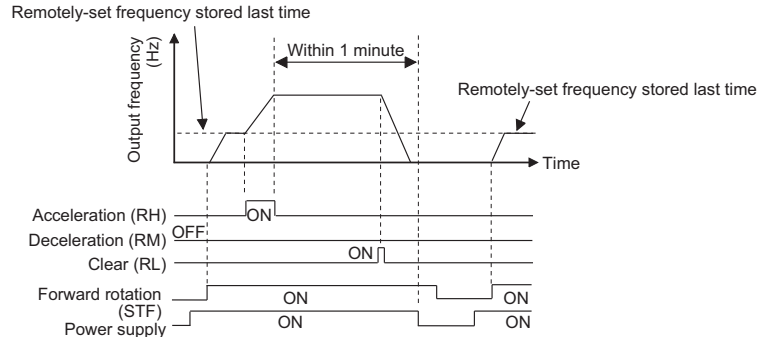

- When the remotely-set frequency is cleared by turning ON the clear (RL) signal after turning OFF (ON) both the RH and RM signals, the inverter operates at the frequency in the remotely-set frequency cleared state if power is reapplied before one minute has elapsed since turning OFF (ON) both the RH and RM signals.

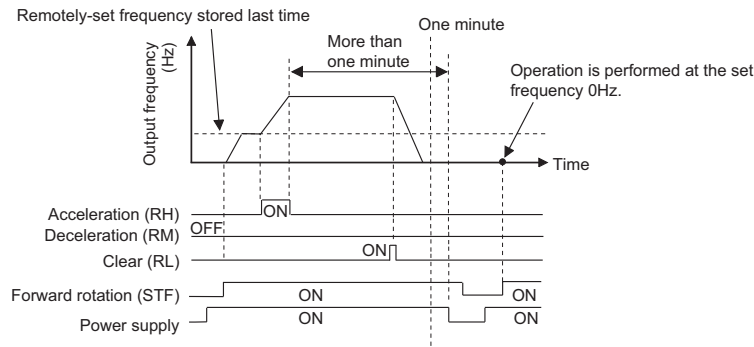

**CAUTION**

- When using the remote setting function, set the maximum frequency again according to the machine.

Parameters referred to

- Pr.1 Maximum frequency, Pr.18 High speed maximum frequency [page 428](#)
- Pr.7 Acceleration time, Pr.8 Deceleration time, Pr.44 Second acceleration/deceleration time, Pr.45 Second deceleration time [page 367](#)
- Pr.28 Multi-speed input compensation selection [page 411](#)
- Pr.178 to Pr.189 (Input terminal function selection) [page 521](#)

### 5.8.4 Starting frequency and start-time hold function

V/F Magnetic flux Sensorless Vector

It is possible to set the starting frequency and hold the set starting frequency for a certain period of time. Set these functions when a starting torque is needed or the motor drive at start needs smoothing.

Pr.	Name	Initial value	Setting range	Description
13 F102	Starting frequency	0.5 Hz	0 to 60 Hz	Set the starting frequency at which the start signal is turned ON.
571 F103	Holding time at a start	9999	0 to 10 s	Set the holding time of the frequency set in Pr.13.
			9999	The holding function at start is disabled.

#### Starting frequency setting (Pr.13)

- The frequency at start can be set in the range of 0 to 60 Hz.
- Set the starting frequency at which the start signal is turned ON.

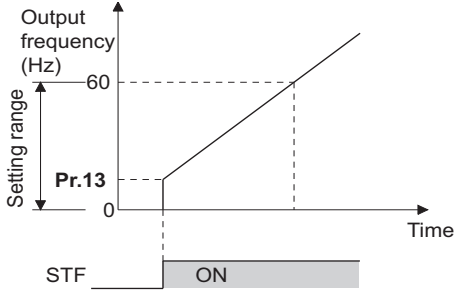

**NOTE**

- The inverter does not start if the frequency setting signal has a value lower than that of Pr.13. For example, while Pr.13 = 5 Hz, the inverter output starts when the frequency setting signal reaches 5 Hz.

#### Start-time hold function (Pr.571)

- This function holds during the period set in Pr.571 and the output frequency set in Pr.13 Starting frequency.

- This function performs initial excitation to smooth the motor drive at a start.

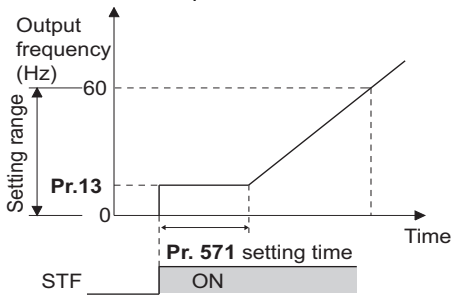

### NOTE

- When **Pr.13** = 0 Hz, the starting frequency is held at 0.01 Hz.
- When the start signal was turned OFF during start-time hold, deceleration is started at that point.
- At switching between forward rotation and reverse rotation, the starting frequency is valid but the start-time hold function is disabled.

### CAUTION

- Note that when **Pr.13** is set to a value equal to or lower than the setting of **Pr.2 Minimum frequency**, simply turning ON the start signal runs the motor at the frequency set in **Pr.2** even if the command frequency is not given.

#### Parameters referred to

Pr.2 Minimum frequency [page 428](#)

## 5.8.5 Minimum motor speed frequency and hold function at the motor start up

### PM

Set the frequency where the PM motor starts running.

Set the deadband in the low-speed range to eliminate noise and offset deviation when setting a frequency with analog input.

Pr.	Name	Initial value	Setting range	Description
13 F102	Starting frequency	Minimum frequency / minimum rotations per minute	0 to 60 Hz	Set the frequency where the motor starts running.
571 F103	Holding time at a start	9999	0 to 10 s 9999	Set the time to hold 0.01 Hz. The holding function at start is disabled.

### ◆ Starting frequency setting (Pr.13)

- The frequency where the PM motor starts running can be set in the range of 0 to 60 Hz.
- When the frequency command specifies the frequency less than the one set in **Pr.13 Starting frequency**, the PM motor is stopped.

When the frequency command specifies the frequency equal to the set frequency or higher, the PM motor accelerates according to the setting of **Pr.7 Acceleration time**.

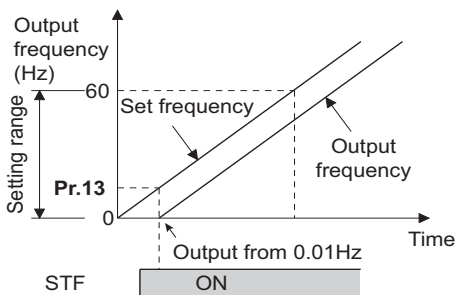

**NOTE**

- Under induction motor control (under V/F control, Advanced magnetic flux vector control, Real sensorless vector control, and Vector control), the output starts at the frequency set in **Pr.13**. Under PM sensorless vector control, the output always starts at 0.01 Hz.
- The inverter does not start if the frequency setting signal has a value lower than that of **Pr.13**. For example, while **Pr.13** = "20 Hz", the inverter output starts when the frequency setting signal reaches 20 Hz.

**◆ Start-time hold function (Pr.571)**

- This function holds 0.01 Hz during the period set in **Pr.571**.
- **Pr.571** is active when the low-speed range high-torque characteristic is enabled (**Pr.788** = "9999").

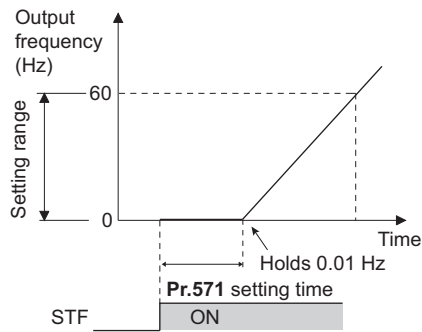

**⚠ CAUTION**

- Note that when **Pr.13** is set to a value equal to or lower than **Pr.2 Minimum frequency**, simply turning ON the start signal runs the motor at the frequency set in **Pr.2** even if the command frequency is not given.

**Parameters referred to**

- Pr.2 Minimum frequency [page 428](#)
- Pr.7 Acceleration time [page 367](#)

## 5.8.6 Shortest acceleration/deceleration and optimum acceleration/deceleration (automatic acceleration/deceleration)



The inverter can be operated with the same conditions as when the appropriate value is set to each parameter even when acceleration/deceleration time and V/F pattern are not set. This function is useful for operating the inverter without setting detailed parameters.

Pr.	Name	Initial value	Setting range	Description
292 F500	Automatic acceleration/ deceleration	0	0	Normal operation
			1	Shortest acceleration/deceleration (without brakes)
			11	Shortest acceleration/deceleration (with brakes)
			3	Optimum acceleration/deceleration
			5, 6	Lift operation 1, 2 (Refer to <a href="#">page 387.</a> )
			7, 8	Brake sequence 1, 2 (Refer to <a href="#">page 572.</a> )
61 F510	Reference current	9999	0 to 500 A <sup>*1</sup>	Set the reference current during shortest (optimum) acceleration/deceleration.
			0 to 3600 A <sup>*2</sup>	
			9999	Rated output current value reference of the inverter
62 F511	Reference value at acceleration	9999	0 to 400%	Set the speed limit value (optimum value) during shortest (optimum) acceleration.
			9999	Shortest acceleration/deceleration: 150% as the limit value, optimum acceleration/deceleration: 100% as the optimum value
63 F512	Reference value at deceleration	9999	0 to 400%	Set the speed limit value (optimum value) during shortest (optimum) deceleration.
			9999	Shortest acceleration/deceleration: 150% as the limit value, optimum acceleration/deceleration: 100% as the optimum value
293 F513	Acceleration/deceleration separate selection	0	0	Shortest (optimum) acceleration/deceleration for both acceleration and deceleration
			1	Shortest (optimum) acceleration/deceleration for acceleration only
			2	Shortest (optimum) acceleration/deceleration for deceleration only

\*1 The setting range of the FR-A820-03160(55K) or lower and the FR-A840-01800(55K) or lower

\*2 The setting range of the FR-A820-03800(75K) or higher and the FR-A840-02160(75K) or higher

### ◆ Shortest acceleration/deceleration (Pr.292 = "1, 11", Pr.293)

- Set this parameter to accelerate/decelerate the motor at the shortest time. This function is useful when the motor needs to be accelerated/decelerated at a shorter time, such as for a machine, but the designed value of the machine constant is not known.
- At acceleration/deceleration, this function adjusts the motor to accelerate/decelerate with the maximum inverter output torque using the **Pr.7 Acceleration time** and **Pr.8 Deceleration time** setting as reference. (**Pr.7** and **Pr.8** settings are not changed.)
- Use **Pr.293 Acceleration/deceleration separate selection** to apply the shortest acceleration/deceleration to one of acceleration and deceleration only.

When "0 (initial value)" is set, the shortest acceleration/deceleration is performed for both acceleration and deceleration.

- Since the FR-A820-00490(7.5K) or lower, FR-A840-00250(7.5K) or lower capacity inverters are equipped with built-in brake resistors, set **Pr.292** to "11". Set "11" also when a high-duty brake resistor or brake unit is connected. The deceleration time can further be shortened.

- When the shortest acceleration/deceleration is selected under V/F control and Advanced magnetic flux vector control, the stall prevention operation level during acceleration/deceleration becomes 150% (adjustable using **Pr.61 to Pr.63**). The setting of **Pr.22 Stall prevention operation level** and stall level by analog input are used only during a constant speed operation.  
Under Real sensorless vector control and Vector control, the torque limit level (**Pr.22**, etc.) is applied during acceleration/deceleration. The adjustments by **Pr.61 to Pr.63** are disabled.
- It is inappropriate to use for the following applications.
  - Machines with large inertia (10 times or more), such as a fan. Since stall prevention operation is activated for a long time, this type of machine may be shut off due to motor overloading, etc.
  - When the inverter is always operated at a specified acceleration/deceleration time.

#### NOTE

- Even if automatic acceleration/deceleration has been selected, inputting the JOG signal (JOG operation), RT signal (Second function selection) or X9 signal (Third function selection) during an inverter stop switches to the normal operation and give priority to JOG operation, second function selection or third function selection. Note that during operation, an input of JOG and RT signal does not have any influence even when the automatic acceleration/deceleration is enabled.
- Since acceleration/deceleration is made with the stall prevention operation being activated, the acceleration/deceleration speed always varies according to the load conditions.
- By setting **Pr.7** and **Pr.8** appropriately, it is possible to accelerate/decelerate with a shorter time than when selecting the shortest acceleration/deceleration.

### ◆ Optimum acceleration/deceleration (Pr.292 = "3", Pr.293)

- The inverter operates at the most efficient level within the rated range that can be used continuously with reasonable inverter capacity. Using self-learning, the average current during acceleration/deceleration is automatically set so as to become the rated current. This is ideal for applications operated with a predetermined pattern and minimal load fluctuations, such as by an automatically operated conveyor.
- When the optimum acceleration/deceleration is selected, at first, the operation is performed with the values set in **Pr.0 Torque boost**, **Pr.7 Acceleration time**, and **Pr.8 Deceleration time**. After the first operation is completed, average and peak currents are calculated based on the motor current during acceleration/deceleration, and the obtained values are compared with the reference current (initially set to the rated inverter current) to adjust the **Pr.0**, **Pr.7**, and **Pr.8** settings to their optimal values. The operation is performed with the updated **Pr.0**, **Pr.7**, and **Pr.8** values onwards, and those parameters settings are adjusted each time. Under Advanced magnetic flux vector control, Real sensorless vector control and Vector control, however, the **Pr.0** setting is not changed.
- When a Regenerative overvoltage trip during deceleration or stop (E.OV3) occurs during deceleration, the setting of **Pr.8** is multiplied by 1.4.
- The optimum values of **Pr.0**, **Pr.7** and **Pr.8** are written to both the parameter RAM and EEPROM only three times of acceleration (deceleration) after the optimum acceleration/deceleration has been selected or after the power is switched ON or the inverter is reset. At or after the fourth attempt, they are not stored into EEPROM. Hence, after power-ON or inverter reset, the values changed at the third time are valid. However, the optimum values are calculated even for the fourth time and later, and **Pr.0**, **Pr.7**, and **Pr.8** are set to the RAM; therefore, these can be stored to the EEPROM by reading and writing the settings with the operation panel (FR-DU08).

Number of optimum value changes	Pr.0, Pr.7, Pr.8		Operating condition
	EEPROM value	RAM value	
1 to 3 times	Updated	Updated	Updated
4 and more times	Unchanged from the 3rd value	Updated	Updated

- Either acceleration or deceleration can be made in the optimum acceleration/deceleration using **Pr.293 Acceleration/deceleration separate selection**. When the setting value is "0" (initial value), both acceleration and deceleration are made in the optimum acceleration/deceleration.
- It is inappropriate for machines which change in load and operation conditions. Optimum values are saved for the next operation. If the operating condition changes before the next operation, a fault such as overcurrent trip or a lack of acceleration/deceleration may occur.

**NOTE**

- Even if automatic acceleration/deceleration has been selected, inputting the JOG signal (JOG operation), RT signal (Second function selection) or X9 signal (Third function selection) during an inverter stop will switch to the normal operation and give priority to JOG operation, second function selection or third function selection. Note that JOG and RT signal input is invalid even if JOG signal and RT signal are input during operation in the optimum acceleration/deceleration mode.
- Because of the learning method, the impact of the optimum acceleration/deceleration is not apparent in the first operation after setting to the optimum acceleration/deceleration mode.
- The optimum value are calculated for only acceleration from 0 to 30 Hz or higher or deceleration from 30 Hz or higher to 0 Hz.
- The optimum acceleration/deceleration will not operate if the motor was not connected or the output current is less than 5% of the rated current of the inverter.
- A Regenerative overvoltage trip during deceleration or stop (E.OV3) may occur during deceleration even if the optimum acceleration/deceleration is selected with **Pr.293** ="1 (optimum acceleration/deceleration during acceleration only)" setting. In such case, set **Pr.8** setting longer.

## ◆ Shortest and optimum acceleration/deceleration mode adjustment (Pr.61 to Pr.63)

- The application range can be expanded by setting the parameters for adjustment of **Pr.61 to Pr.63**.

Pr.	Name	Setting range	Description
61	Reference current	0 to 500 A <sup>*1</sup>	Set the rated motor current value such as when the motor capacity and inverter capacity differ.
		0 to 3600 A <sup>*2</sup>	Shortest acceleration/deceleration: Set the reference current (A) of the stall prevention operation level during acceleration/deceleration. Optimum acceleration/deceleration: Set the reference current (A) of the optimum current during acceleration/deceleration.
		9999 (initial value)	The rated inverter current value is the reference.
62, 63	Reference value at acceleration, Reference value at deceleration	0 to 400%	Set this when changing the reference level of acceleration and deceleration. Shortest acceleration/deceleration: Set the stall prevention operation level (percentage of current value of <b>Pr.61</b> ) during acceleration/deceleration. Optimum acceleration/deceleration: Set the optimum current level (percentage of current value of <b>Pr.61</b> ) during acceleration/deceleration.
		9999 (initial value)	Shortest acceleration/deceleration: Stall prevention operation level is 150% for the shortest acceleration/deceleration. Optimum acceleration/deceleration: 100% as the optimum value.

\*1 The setting range of the FR-A820-03160(55K) or lower and the FR-A840-01800(55K) or lower

\*2 The setting range of the FR-A820-03800(75K) or higher and the FR-A840-02160(75K) or higher

**NOTE**

- When Real sensorless vector control or Vector control is selected with the shortest acceleration/deceleration, **Pr.61 to Pr.63** are invalid.
- Even if **Pr.61 to Pr.63** are set once, changing the setting to other than the shortest acceleration/deceleration (**Pr.292** ≠ "1 or 11") automatically resets to the initial setting (9999). Set **Pr.61 to Pr.63** after setting **Pr.292**.

« Parameters referred to »

Pr.0 Torque boost  page 706

Pr.7 Acceleration time, Pr.8 Deceleration time  page 367

Pr.22 Stall prevention operation level  page 431

Pr.22 Torque limit level  page 245

## 5.8.7 Lift operation (automatic acceleration/ deceleration)



The inverter can be operated according to the load pattern of the lift with counterweight.

Pr.	Name	Initial value	Setting range	Description
292 F500	Automatic acceleration/ deceleration	0	0	Normal operation
			1	Shortest acceleration/deceleration (without brakes)
			11	Shortest acceleration/deceleration (with brakes)
			3	Optimum acceleration/deceleration
			5	Lift operation 1 (stall prevention operation level 150%)
			6	Lift operation 2 (stall prevention operation level 180%)
			7, 8	Brake sequence 1, 2 (Refer to page 572.)
			(Refer to page 384.)	
61 F510	Reference current	9999	0 to 500 A <sup>*1</sup>	Set the reference current during shortest (optimum) acceleration/deceleration.
			0 to 3600 A <sup>*2</sup>	
			9999	Rated output current value reference of the inverter
64 F520	Starting frequency for elevator mode	9999	0 to 10 Hz	Set the starting frequency for the lift operation.
			9999	The starting frequency is 2 Hz.

\*1 The setting range of the FR-A820-03160(55K) or lower and the FR-A840-01800(55K) or lower

\*2 The setting range of the FR-A820-03800(75K) or higher and the FR-A840-02160(75K) or higher

### ◆ Lift operation (Pr.292 = "5, 6")

- When Pr.292 Automatic acceleration/deceleration is set to "5" or "6", the lift operation is selected, and each setting is changed, as shown in the following table.
- During power driving, sufficient torque is generated, and during regenerative driving and during driving with no load, the torque boost setting is adjusted automatically so as not to activate the overcurrent protective function by overexcitation.

Name	Normal operation	Multi-rating (Pr.570)	Lift operation (Pr.292)	
			5	6
Torque boost	Pr.0 (6/4/3/2/1%)		Changes according to the output current (as shown below)	
Starting frequency	Pr.13 (0.5 Hz)		Pr.64 (2 Hz) Accelerate after 100 ms hold.	
Base frequency voltage	Pr.19 (9999)		220 V class (440 V class)	
Stall prevention operation level	Pr.22 (150%), etc.	0 (SLD)	110%	115%
		1 (LD)	120%	140%
		2 (ND) initial value	150%	180%
		3 (HD)	200%	230%

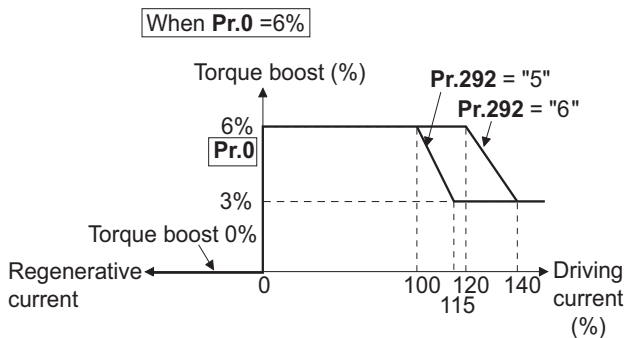

- If the lift has a load in which the rated current of the inverter is exceeded, the maximum torque may be insufficient. For a lift without counterweight, setting Pr.14 Load pattern selection to "2 or 3" (for lift load) and setting Pr.19 Base frequency voltage appropriately give the maximum torque a greater advantage than when selecting the lift operation.



**NOTE**

- The stall prevention operation level is automatically lowered according to the cumulative value of the electronic thermal O/L relay so as to prevent an inverter overload trip (E.THT) and the motor overload trip (E.THM) from occurring.

**◆ Lift operation adjustment (Pr.61, Pr.64)**

- The application range can be expanded by setting the parameters for adjustment of **Pr.61** and **Pr.64**.

Pr.	Name	Setting range	Description
61	Reference current	0 to 500 A <sup>*1</sup>	Set the rated motor current value such as when the motor capacity and inverter capacity differ.
		0 to 3600 A <sup>*2</sup>	Set the reference current (A) of the stall prevention operation level.
		9999 (initial value)	The rated inverter output current value is the reference.
64	Starting frequency for elevator mode	0 to 10 Hz	Set the starting frequency for the lift operation.
		9999 (initial value)	The starting frequency is 2 Hz.

\*1 The setting range of the FR-A820-03160(55K) or lower and the FR-A840-01800(55K) or lower

\*2 The setting range of the FR-A820-03800(75K) or higher and the FR-A840-02160(75K) or higher

**NOTE**

- Even if the lift operation has been selected, inputting the JOG signal (JOG operation), RT signal (Second function selection) or X9 signal (Third function selection) during an inverter stop will disable the automatic acceleration/deceleration and give priority to JOG operation, second function selection or third function selection. Note that during operation, an input of JOG and RT signal does not have any influence even when the automatic acceleration/deceleration is enabled.
- Even if **Pr.61** and **Pr.64** are set, changing **Pr.292** automatically resets to the initial setting (9999). Set **Pr.61** and **Pr.64** after setting **Pr.292**.

**Parameters referred to**

Pr.0 Torque boost [page 706](#)

Pr.13 Starting frequency [page 381](#)

Pr.14 Load pattern selection [page 708](#)

Pr.19 Base frequency voltage [page 707](#)

Pr.22 Stall prevention operation level [page 431](#)

Pr.570 Multiple rating setting [page 343](#)

## 5.9 (D) Operation command and frequency command

Purpose	Parameter to set			Refer to page
To select the operation mode	Operation mode selection	P.D000	Pr.79	389
To start up the inverter in Network operation mode at power-ON	Communication startup mode selection	P.D000, P.D001	Pr.79, Pr.340	398
To select the command source during communication operation	Operation and speed command sources during communication operation, command source selection	P.D010 to P.D013	Pr.338, Pr.339, Pr.550, Pr.551	400
To prevent the motor from rotating reversely	Reverse rotation prevention selection	P.D020	Pr.78	406
To change the setting resolution of speed	Set resolution switchover	P.D030	Pr.811	444
To change the setting resolution of the torque limit	Set resolution switchover	P.D030	Pr.811	444
To set the frequency using pulse train input	Pulse train input	P.D100, P.D101, P.D110, P.D111	Pr.291, Pr.384 to Pr.386	406
To perform JOG (inching) operation	JOG operation	P.D200, P.F002	Pr.15, Pr.16	410
To control the frequency with combinations of terminals	Multi-speed operation	P.D300 to P.D315	Pr.28, Pr.4 to Pr.6, Pr.24 to Pr.27, Pr.232 to Pr.239	411
To select the torque command method during torque control	Torque command source selection	P.D120, P.D121, P.D400 to P.D402	Pr.432, Pr.433, Pr.804 to Pr.806	283









































### 5.9.1 Operation mode selection

Select the operation mode of the inverter.

The mode can be changed among operations using external signals (External operation), operation by the operation panel or the parameter unit (PU operation), combined operation of PU operation and External operation (External/PU combined operation), and Network operation (when RS-485 terminals or a communication option is used).

Pr.	Name	Initial value	Setting range	Description
79 D000	Operation mode selection	0	0 to 4, 6, 7	Selects the operation mode.

The following table lists valid and invalid commands in each operation mode.

Pr.79 setting	Description			LED indicator ☐: OFF ☐: ON	Refer to page
0 (initial value)	External/PU switchover mode. The inverter operation mode can be switched between PU and External by pressing  . At power ON, the inverter is in the External operation mode.			PU operation mode    External operation mode    NET operation mode   	394
1	<b>Operation mode</b>	<b>Frequency command</b>	<b>Start command</b>	PU operation mode   	394
	Fixed at PU operation mode.	Sent from the operation panel or parameter unit.	Sent by pressing  or  on operation panel or parameter unit.		
2	Fixed at External operation mode. However, the inverter operation mode can also be changed to the Network operation mode.	Sent using external signals (input via terminal 2 or 4, using the JOG signal, using the multi-speed setting function, etc.).	Sent using external signals (via terminal STF or STR).	External operation mode    NET operation mode   	394
3	External/PU combined operation mode 1	Sent from the operation panel or parameter unit or sent using external signals (input using the multi-speed setting function or via terminal 4). <sup>*1</sup>	Sent using external signals (via terminal STF or STR).	External/PU combined operation mode   	394
4	External/PU combined operation mode 2	Sent using external signals (input via terminal 2 or 4, using the JOG signal, using the multi-speed setting function, etc.).	Sent by pressing  or  on operation panel or parameter unit.	External/PU combined operation mode   	395
6	Operation mode switchover during operation. Switching from among the PU, External, and NET operation modes can be performed during operation.			PU operation mode    External operation mode   	395
7	External operation mode (PU operation interlock). X12 signal ON: Switchover to PU operation mode enabled (signal is OFF during External operation). X12 signal OFF: Switchover to PU operation mode disabled.			External operation mode    NET operation mode   	395

\*1 The following is the frequency commands listed in descending order of priority when "3" is set in **Pr.79**: Multi-speed setting function (RL/RM/RH/REX signal) > PID control (X14 signal) > terminal 4 analog input (AU signal) > digital input from the operation panel.

## ◆ Operation mode basics

- The operation mode specifies the source of the start command and the frequency command for the inverter.

- Basic operation modes are as follows.

**External operation mode:** For giving a start command and a frequency command with an external potentiometer or switches which are connected to the control circuit terminal.

**PU operation mode :** For giving a start command and a frequency command from the operation panel, parameter unit, or through RS-485 communication via the PU connector.

**Network operation mode (NET operation mode)** : For giving a start command and a frequency command via the RS-485 terminals or communication option.

- The operation mode can be selected from the operation panel or with the communication instruction code.

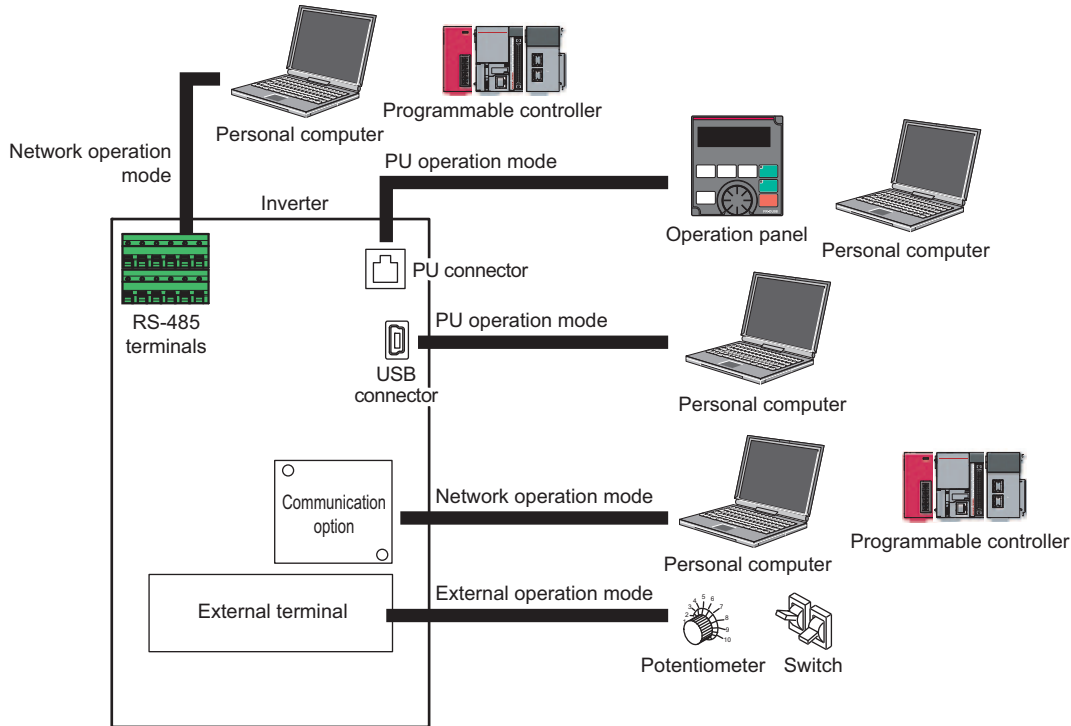

**NOTE**

- There is a choice of two settings, "3" and "4", for the External/PU combined operation mode. The startup method differs according to the setting value.
- In the initial setting, the PU stop selection (function to stop the inverter operation by pressing  on the operation panel or the parameter unit) is enabled even in the operation mode other than the PU operation mode. (Refer to **Pr.75** on [page 336](#).)

## ◆ Operation mode switching method

When "0, 1, or 2" is set in Pr. 340

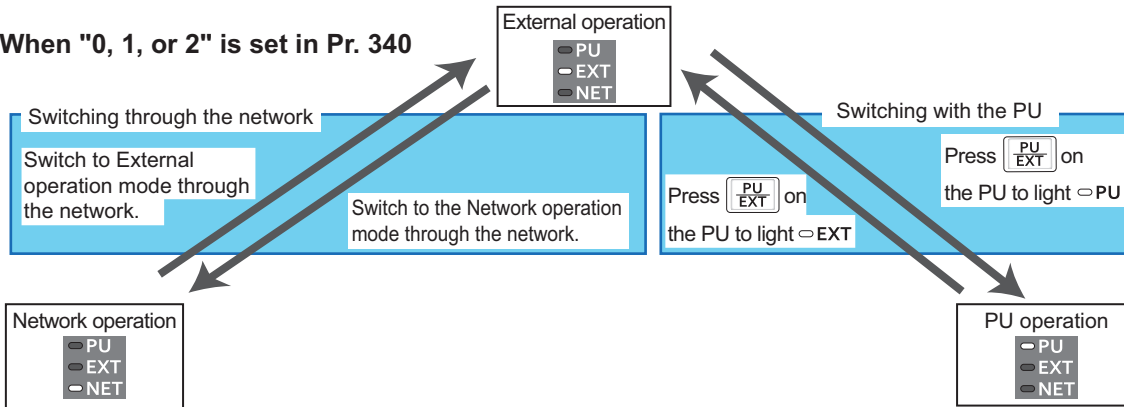

When "10 or 12" is set in Pr. 340

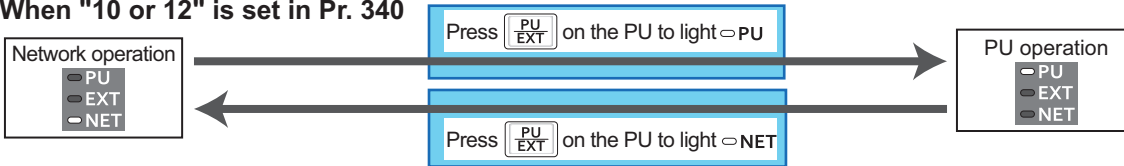

### NOTE

- For details on switching by external terminals, refer to the following pages.
  - PU operation external interlock (X12 signal)** [page 395](#)
  - PU/External operation switchover (X16 signal)** [page 396](#)
  - PU/NET operation switchover (X65 signal), External/NET operation switchover (X66 signal)** [page 397](#)
  - Pr.340 Communication startup mode selection** [page 398](#)

## ◆ Operation mode selection flow

Referring to the following table, select the basic parameter settings or terminal wiring related to the operation mode.

Method to give start command	Method to give frequency setting command	Input interface	Parameter setting	Operation method
Using external signals (via terminal STF/STR)	Using external signals (input via terminal 2/4, using the JOG signal, using the multi-speed setting function, etc.)	Terminal STF (forward rotation) / STR (reverse rotation). (Refer to page <a href="#">page 722.</a> ) Terminal 2 and 4 (analog), RL, RM, RH, JOG, etc.	<b>Pr.79</b> = "2" (Fixed at External operation mode)	<ul style="list-style-type: none"> <li>Frequency setting: Turn ON a terminal used for frequency setting.</li> <li>Start command: Turn ON terminal STF/STR.</li> </ul>
	From PU (digital setting)	Terminal STF (forward rotation) / STR (reverse rotation). (Refer to <a href="#">page 722.</a> )	<b>Pr.79</b> = "3" (External/PU combined operation mode 1)	<ul style="list-style-type: none"> <li>Frequency setting: Use the DU (digital setting).</li> <li>Start command: Turn ON terminal STF/STR.</li> </ul>
	Through communication (via RS-485 terminals)	Terminal STF (forward rotation) / STR (reverse rotation). (Refer to <a href="#">page 722.</a> ) RS-485 terminals (Refer to <a href="#">page 661.</a> )	<b>Pr.338</b> = "1" <b>Pr.340</b> = "1 or 2"	<ul style="list-style-type: none"> <li>Frequency setting: Transmit a frequency command through communication.</li> <li>Start command: Turn ON terminal STF/STR.</li> </ul>
	Through communication (via communication option)	Terminals for communication option (Refer to the Instruction Manual of the communication option.)	<b>Pr.338</b> = "1" <b>Pr.340</b> = "1"	<ul style="list-style-type: none"> <li>Frequency setting: Transmit a frequency command through communication.</li> <li>Start command: Turn ON terminal STF/STR.</li> </ul>
From PU (using FWD/REV key)	Using external signals (input via terminal 2/4, using the JOG signal, using the multi-speed setting function, etc.)	Terminals 2/4 (analog), RL, RM, RH, JOG, etc.	<b>Pr.79</b> = "4" (External/PU combined operation mode 2)	<ul style="list-style-type: none"> <li>Frequency setting: Turn ON a terminal used for frequency setting.</li> <li>Start command: Press the FWD/REV key.</li> </ul>
	From PU (digital setting)	—	<b>Pr.79</b> = "1" (Fixed at PU operation mode)	<ul style="list-style-type: none"> <li>Frequency setting: Use the PU (digital setting).</li> <li>Start command: Press the FWD/REV key.</li> </ul>
	Through communication (via RS-485 terminals / communication option)	Not available.		
Through communication (via RS-485 terminals)	Using external signals (input via terminal 2/4, using the JOG signal, using the multi-speed setting function, etc.)	RS-485 terminals (Refer to <a href="#">page 661.</a> ) Terminal 2 and 4 (analog), RL, RM, RH, JOG, etc.	<b>Pr.339</b> = "1" <b>Pr.340</b> = "1 or 2"	<ul style="list-style-type: none"> <li>Frequency setting: Turn ON a terminal used for frequency setting.</li> <li>Start command: Transmit a start command through communication.</li> </ul>
	From PU (digital setting)	Not available.		
	Through communication (via RS-485 terminals)	RS-485 terminals (refer to <a href="#">page 661</a> )	<b>Pr.340</b> = "1 or 2"	<ul style="list-style-type: none"> <li>Frequency setting: Transmit a frequency command through communication.</li> <li>Start command: Transmit a start command through communication.</li> </ul>
Through communication (via communication option)	Using external signals (input via terminal 2/4, using the JOG signal, using the multi-speed setting function, etc.)	Terminals on communication option (Refer to the Instruction Manual of the communication option.) Terminal 2 and 4 (analog), RL, RM, RH, JOG, etc.	<b>Pr.339</b> = "1" <b>Pr.340</b> = "1"	<ul style="list-style-type: none"> <li>Frequency setting: Turn ON a terminal used for frequency setting.</li> <li>Start command: Transmit a start command through communication.</li> </ul>
	From PU (digital setting)	Not available.		
	Through communication (via communication option)	Terminals on communication option (Refer to the Instruction Manual of the communication option.)	<b>Pr.340</b> = "1"	<ul style="list-style-type: none"> <li>Frequency setting: Transmit a frequency command through communication.</li> <li>Start command: Transmit a start command through communication.</li> </ul>

## ◆ External operation mode (Pr.79 = "0 (initial value) or 2")

- Select the External operation mode when the start command and the frequency command are applied from a frequency setting potentiometer, start switch, etc. which are provided externally and connected to the control circuit terminals of the inverter.
- Generally, parameter change cannot be performed in the External operation mode. (Some parameters can be changed. Refer to Pr.77 on page 345.)
- When Pr.79 = "0 or 2", the inverter starts up in the External operation mode at power-ON. (When using the Network operation mode, refer to page 398.)
- When parameter changing is seldom necessary, setting "2" fixes the operation mode to the External operation mode. When frequent parameter changing is necessary, setting "0 (initial value)" allows the operation mode to be changed easily to the PU operation mode by pressing  on the operation panel. After switching to the PU operation mode, always return to the External operation mode.
- The STF or STR signal is used as a start command. The input voltage or current via terminal 2 or 4, multi-speed setting signal, or JOG signal is used as a frequency command.

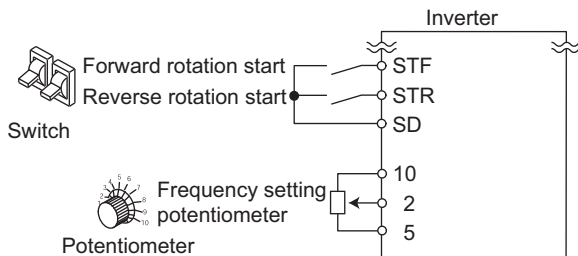

## ◆ PU operation mode (Pr.79 = "1")

- Select the PU operation mode when giving start and frequency commands by only the key operation of the operation panel or the parameter unit.
- Also select the PU operation mode when giving commands through communication via the PU connector.
- When Pr.79 = "1", the inverter starts up in the PU operation mode at power-ON. The mode cannot be changed to other operation modes.
  - The frequency can also be set by simply turning the setting dial on the operation panel like a volume knob. (Refer to Pr.161 **Frequency setting/key lock operation selection** on page 341.)
  - When the PU operation mode is selected, the PU operation mode (PU) signal can be output.

For the terminal used for the PU signal, set "10 (positive logic)" or "110 (negative logic)" in any of Pr.190 to Pr.196 (**Output terminal function selection**) to assign the function.

Operation panel (FR-DU08)

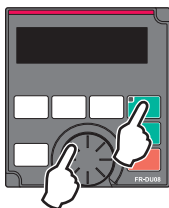

## ◆ PU/External combined operation mode 1 (Pr.79 = "3")

- Select the PU/External combined operation mode 1 when giving a frequency command from the operation panel or the parameter unit and giving a start command with the external start switches.
- Set "3" in Pr.79. The mode cannot be changed to other operation modes.
- When the frequency commands are given using the multi-speed setting signals (external signals), they have a higher priority than the frequency commands given from the PU. When the AU signal is ON, inputting the command signals via terminal 4 is enabled.

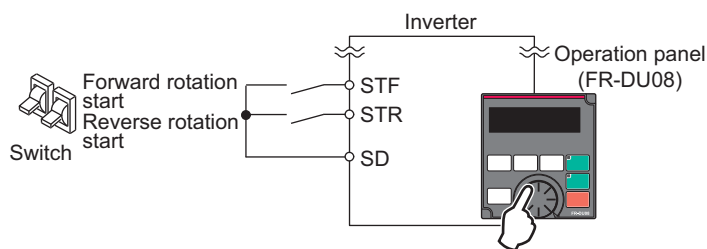

## ◆ PU/External combined operation mode 2 (Pr.79 = "4")

- Select the PU/External combined operation mode 2 when giving a frequency command from the external potentiometer, or using the multi-speed setting signals or the JOG signal, and giving a start command by key operation of the operation panel or the parameter unit.
- Set "4" in **Pr.79**. The mode cannot be changed to other operation modes.

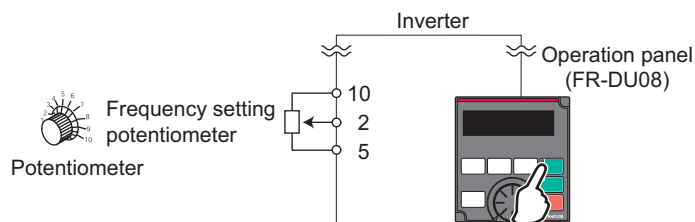

## ◆ Operation mode switchover during operation (Pr.79 = "6")

- During operation, the inverter operation mode can be switched from among the PU, External, and Network (Network operation mode is selectable when RS-485 terminals or communication option is used).

Operation mode switchover	Operation/operating status
External operation→PU operation	Use the operation panel or parameter unit to change to the PU operation mode. <ul style="list-style-type: none"> <li>• The direction of motor rotation does not change due to the operation mode change from the External operation mode.</li> <li>• The previous setting of frequency which has been set using a potentiometer (frequency command) is taken over. (However, note that the setting disappears when the power is turned OFF or when the inverter is reset.)</li> </ul>
External operation→NET operation	Give the command through communication to change the operation mode to the Network operation mode. <ul style="list-style-type: none"> <li>• The direction of motor rotation does not change due to the operation mode change from the External operation mode.</li> <li>• The previous setting of frequency which has been set using a potentiometer (frequency command) is taken over. (However, note that the setting disappears when the power is turned OFF or when the inverter is reset.)</li> </ul>
PU operation→External operation	Press the key on the operation panel or parameter unit to change the operation mode to the External operation mode. <ul style="list-style-type: none"> <li>• The direction of operation is determined by external input signals used in the External operation mode.</li> <li>• The setting frequency is determined by the external frequency command signal.</li> </ul>
PU operation→NET operation	Give the command through communication to change the operation mode to the Network operation mode. <ul style="list-style-type: none"> <li>• The direction of motor rotation and the frequency setting does not change due to the operation mode change from the PU operation mode.</li> </ul>
NET operation→External operation	Give the command through communication to change the operation mode to the External operation mode. <ul style="list-style-type: none"> <li>• The direction of operation is determined by external input signals used in the External operation mode.</li> <li>• The setting frequency is determined by the external frequency command signal.</li> </ul>
NET operation→PU operation	Use the operation panel or parameter unit to change to the PU operation mode. <ul style="list-style-type: none"> <li>• The direction of motor rotation and the frequency setting does not change due to the operation mode change from the Network operation mode.</li> </ul>

## ◆ PU operation interlock (Pr.79 = "7")

- The operation mode can be forcibly switched to the External operation mode by turning OFF the PU operation external interlock (X12) signal. This function will be usable in a case where the inverter does not reply to external command signals during operation due to the operation mode accidentally unswitched from the PU operation mode to the External operation mode.
- To input the X12 signal, set "12" in any of **Pr.178 to Pr.189 (Input terminal function selection)** to assign the function. (For details on **Pr.178 to Pr.189**, refer to [page 521](#).)
- Set **Pr.79 = "7"** (PU operation interlock).



- If the X12 signal is not assigned, the function of the MRS signal is switched to the PU operation interlock signal from MRS (output stop).

X12 (MRS) signal	Function/Operation	
	Operation mode	Parameter writing <sup>*1</sup>
ON	Switching of the operation mode (External, PU, and NET) is enabled. The signal is OFF during External operation.	Enabled.
OFF	Operation mode is forcefully changed to the External operation mode. External operation is enabled. Switching to the PU or NET operation mode from the External operation mode is disabled.	Disabled except for <b>Pr.79</b> .

\*1 Depends on the **Pr.77 Parameter write selection** setting and other parameter write conditions. (Refer to [page 345](#).)

- Functions/operations by X12 (MRS) signal ON/OFF

Operating status		X12 (MRS) signal	Operation mode	Operating status	Switching to PU or NET operation mode
Operation mode	Status				
PU/NET	During stop	ON→OFF <sup>*1</sup>	External <sup>*2</sup>	If frequency and start commands are given from external source, the inverter runs by those commands.	Disabled
	During running	ON→OFF <sup>*1</sup>			Disabled
External	During stop	OFF→ON	External <sup>*2</sup>	During stop	Enabled
		ON→OFF			Disabled
	During running	OFF→ON		Running→Output stop	Disabled
		ON→OFF		Output stop→Running	Disabled

\*1 The mode is switched to the External operation mode regardless of the ON/OFF state of the start signal (STF/STR). Thus, the motor runs under the External operation mode when the X12 (MRS) signal turns OFF while the STF or STR signal is ON.

\*2 When a fault occurs, the inverter can be reset by pressing  on the operation panel.

## NOTE

- The operation mode cannot be switched to the PU operation mode with the start signal (STF/STR) ON state even if the X12 (MRS) signal turns ON.
- If the MRS signal is ON and **Pr.79** is written to a value other than "7" when the MRS signal is used as the PU interlock signal, the MRS signal will act as a regular MRS function (output stop). Also, when **Pr.79** = "7", the MRS signal becomes the PU interlock signal.
- The logic of the signal follows the setting of **Pr.17 MRS input selection** also when the MRS signal is used as the PU operation interlock signal. When **Pr.17** = "2", ON and OFF in the above explanation are reversed.
- Changing the terminal assignment using **Pr.178 to Pr.189 (Input terminal function selection)** may affect the other functions. Set parameters after confirming the function of each terminal.

## ◆ Switching operation mode by external signal (X16 signal)

- When External operation and the operation from the operation panel are used together, the PU operation mode and External operation mode can be switched during a stop (during motor stop, start command OFF) by using the PU/External operation switchover (X16) signal.
- When **Pr.79** = "0, 6, or 7", switching between the PU operation mode and External operation mode is possible. (When **Pr.79** = "6", switchover is enabled during operation.)

- To input the X16 signal, set "16" in any of **Pr.178 to Pr.189 (Input terminal function selection)** to assign the function to a terminal.

Pr.79 setting		X16 signal status and operation mode		Remarks
		ON (External)	OFF (PU)	
0 (initial value)		External operation mode	PU operation mode	Switching among the External, PU, and NET operation modes is enabled.
1		PU operation mode		Fixed at PU operation mode.
2		External operation mode		Fixed at External operation mode (Switching to NET operation mode enabled).
3, 4		External/PU combined operation mode		Fixed at External/PU combined operation mode.
6		External operation mode	PU operation mode	Switching among the External, PU, and NET operation mode is enabled during operation.
7	X12 (MRS) ON	External operation mode	PU operation mode	Switching among the External, PU, and NET operation mode is enabled (signal is OFF in the External operation mode).
	X12 (MRS) OFF	External operation mode		Fixed at External operation mode (forcibly switched to External operation mode).

#### NOTE

- The operation mode is determined by the setting of **Pr.340 Communication startup mode selection** and the ON/OFF state of the X65 and X66 signals. (For the details, refer to [page 397](#).)
- The priority of **Pr.79** and **Pr.340** and signals is **Pr.79** > X12 > X66 > X65 > X16 > **Pr.340**.
- Changing the terminal assignment using **Pr.178 to Pr.189 (Input terminal function selection)** may affect the other functions. Set parameters after confirming the function of each terminal.

### ◆ Switching the operation mode by external signals (X65, X66 signals)

- When **Pr.79** = "0, 2 or 6", the PU operation mode and External operation modes can be changed to the Network operation mode during a stop (during motor stop, start command OFF) by the PU/NET operation switchover (X65) signal, or the External/NET operation switchover (X66) signal. (When **Pr.79** = "6", switchover is enabled during operation.)
- To switch between the Network operation mode and the PU operation mode
  - Set **Pr.79** = "0 (initial value) or 6".
  - Set **Pr.340 Communication startup mode selection** = "10 or 12".
  - Set "65" in any of **Pr.178 to Pr.189** to assign the PU/NET operation switchover (X65) signal to a terminal.
  - When the X65 signal is ON, the PU operation mode is selected. When the X65 signal is OFF, the NET operation mode is selected.

Pr.340 setting	Pr.79 setting	X65 signal state		Remarks	
		ON (PU)	OFF (NET)		
10, 12	0 (initial value)	PU operation mode <sup>*1</sup>	NET operation mode <sup>*2</sup>	—	
	1	PU operation mode		Fixed at PU operation mode.	
	2	NET operation mode		Fixed at NET operation mode.	
	3, 4	External/PU combined operation mode		Fixed at External/PU combined operation mode.	
	6	PU operation mode <sup>*1</sup>	NET operation mode <sup>*2</sup>	The operation mode can be changed during operation.	
	7	X12 (MRS) ON	Switching between the External operation mode and PU operation mode is enabled. <sup>*2</sup>		The signal is OFF during operation in the External operation mode.
		X12 (MRS) OFF	External operation mode		The operation mode is forcibly switched to the External operation mode.

\*1 When the X66 signal is ON, the NET operation mode is selected.

\*2 When the X16 signal is OFF, the PU operation mode is selected. Also, when "0" is set for **Pr.550 NET mode operation command source selection** and the communication option is not connected (communication option is the command source), the PU operation mode is selected. When the X16 signal is ON, the External operation mode is selected.

- To switch between the Network operation mode and the External operation mode
  - Set **Pr.79** = "0 (initial value), 2, 6, or 7". (When **Pr.79** = "7" and the X12 (MRS) signal is ON, the operation mode can be switched.)
  - Set **Pr.340 Communication startup mode selection** = "0" (initial value), "1" or "2".

3. Set "66" in one of **Pr.178 to Pr.189** to assign the NET-External operation switching signal (X66) to a terminal.
4. When the X66 signal is ON, the NET operation mode is selected. When the X66 signal is OFF, the External operation mode is selected.

Pr.340 setting	Pr.79 setting	X66 signal state		Remarks	
		ON (NET)	OFF (External)		
0 (initial value), 1, 2	0 (initial value)	NET operation mode <sup>*1</sup>	External operation mode <sup>*2</sup>	—	
	1	PU operation mode		Fixed at PU operation mode.	
	2	NET operation mode <sup>*1</sup>	External operation mode	Switching to PU operation mode is disabled.	
	3, 4	External/PU combined operation mode		Fixed at External/PU combined operation mode.	
	6	NET operation mode <sup>*1</sup>	External operation mode <sup>*2</sup>	The operation mode can be changed during operation.	
	7	X12 (MRS) ON	NET operation mode <sup>*1</sup>	External operation mode <sup>*2</sup>	The signal is OFF during operation in the External operation mode.
		X12 (MRS) OFF	External operation mode		The operation mode is forcibly switched to the External operation mode.

\*1 When **Pr.550 NET mode operation command source selection** = "0" (communication option control source) and no communication option is connected, the External operation mode is selected.

\*2 When the X16 signal is OFF, the PU operation mode is selected. Also, when the X65 signal is assigned, the operation mode follows the ON/OFF state of the X65 signal.

### NOTE

- The priority of **Pr.79** and **Pr.340** and signals is as follows: **Pr.79** > X12 > X66 > X65 > X16 > **Pr.340**.
- Changing the terminal assignment using **Pr.178 to Pr.189 (Input terminal function selection)** may affect the other functions. Set parameters after confirming the function of each terminal.

### Parameters referred to

Pr.15 Jog frequency [page 410](#)

Pr.4 to Pr.6, Pr.24 to Pr.27, Pr.232 to Pr.239 Multi-speed operation [page 411](#)

Pr.75 Reset selection/disconnected PU detection/PU stop selection [page 336](#)

Pr.161 Frequency setting/key lock operation selection [page 341](#)

Pr.178 to Pr.189 (Input terminal function selection) [page 521](#)

Pr.190 to Pr.196 (Output terminal function selection) [page 473](#)

Pr.340 Communication startup mode selection [page 398](#)

Pr.550 NET mode operation command source selection [page 400](#)

## 5.9.2 Startup of the inverter in Network operation mode at power-ON

When power is switched ON or when power comes back ON after an instantaneous power failure, the inverter can be started up in the Network operation mode.

After the inverter starts up in the Network operation mode, parameter writing and operation can be commanded from programs. Set this mode when performing communication operation using the RS-485 terminals or a communication option.

Pr.	Name	Initial value	Setting range	Description
<b>79</b> <b>D000</b>	<b>Operation mode selection</b>	0	0 to 4, 6, 7	Selects the operation mode. (Refer to <a href="#">page 389</a> .)
<b>340</b> <b>D001</b>	<b>Communication startup mode selection</b>	0	0	The inverter starts up in an operation mode selected in <b>Pr.79</b> .
			1, 2	The inverter starts up in the Network operation mode. If an instantaneous power failure occurs when "2" is set, the operating status before the instantaneous power failure is maintained.
			10, 12	The inverter starts up in the Network operation mode. The operation mode can be changed between the PU operation mode and Network operation mode from the operation panel. If an instantaneous power failure occurs when "12" is set, running is continued at the condition before the instantaneous power failure.

## ◆ Selecting the operation mode for power-ON (Pr.340)

- Depending on the Pr.79 and Pr.340 settings, the operation mode at power-ON (reset) changes as described below.

Pr.340 setting	Pr.79 setting	Operation mode at power-ON, at power restoration, or after a reset	Operation mode switching
0 (initial value)	0 (initial value)	External operation mode	Switching among the External, PU, and NET operation modes is enabled <sup>*2</sup>
	1	PU operation mode	Fixed at PU operation mode.
	2	External operation mode	Switching between the External and NET operation modes is enabled. Switching to PU operation mode is disabled.
	3, 4	External/PU combined operation mode	Operation mode switching is disabled.
	6	External operation mode	Switching among the External, PU, and NET operation mode is enabled while running.
	7	X12 (MRS) signal ON: External operation mode	Switching among the External, PU, and NET operation modes is enabled <sup>*2</sup>
		X12 (MRS) signal OFF: External operation mode	Fixed at External operation mode (forcibly switched to External operation mode).
1, 2 <sup>*1</sup>	0	NET operation mode	Same as Pr.340 = "0".
	1	PU operation mode	
	2	NET operation mode	
	3, 4	External/PU combined operation mode	
	6	NET operation mode	
	7	X12 (MRS) signal ON: NET operation mode	
		X12 (MRS) signal OFF: External operation mode	
10, 12 <sup>*1</sup>	0	NET operation mode	Switching between the PU and NET operation mode is enabled. <sup>*3</sup>
	1	PU operation mode	Same as Pr.340 = "0".
	2	NET operation mode	Fixed at NET operation mode.
	3, 4	External/PU combined operation mode	Same as Pr.340 = "0".
	6	NET operation mode	Switching between the PU and NET operation mode is enabled while running. <sup>*3</sup>
	7	External operation mode	Same as Pr.340 = "0".

\*1 Use Pr.340 = "2 or 12" setting to perform communication with the RS-485 terminals. Even if an instantaneous power failure occurs while Pr.57 Restart coasting time ≠ "9999", the inverter continues running at the condition before the instantaneous failure. When Pr.340 = "1 or 10", if a power failure occurs while the start signal is being input through communication, the start signal is OFF at power restoration.

\*2 The operation mode cannot be directly changed between the PU operation mode and Network operation mode.

\*3 Switching between the PU and NET operation modes is available with the  key on the operation panel and the X65 signal.

### Parameters referred to

Pr.57 Restart coasting time  page 628, page 635

Pr.79 Operation mode selection  page 389

## 5.9.3 Start command source and frequency command source during communication operation

The start and frequency commands given from an external device can be made valid when using the RS-485 terminals or the communication option. The command source in the PU operation mode can also be selected.

Pr.	Name	Initial value	Setting range	Description
338 D010	Communication operation command source	0	0	Start command source is communication.
			1	Start command source is external.
339 D011	Communication speed command source	0	0	Frequency command source is communication.
			1	Frequency command source is external.
			2	Frequency command source is external. (When there is no external input, the frequency command given via communication is valid, and the frequency command given via terminal 2 is invalid.)
550 D012	NET mode operation command source selection	9999	0	The communication option is the command source when in the NET operation mode.
			1	The RS-485 terminals are the command source when in the NET operation mode.
			9999	The communication option is recognized automatically. Normally, the RS-485 terminals are the command source. When the communication option is mounted, the communication option is the command source.
551 D013	PU mode operation command source selection	9999	1	The RS-485 terminals are the command source when in the PU operation mode.
			2	The PU connector is the command source when in the PU operation mode.
			3	The USB connector is the command source when in the PU operation mode.
			9999	USB automatic recognition. Normally, the PU connector is the command source. When the USB is connected, the USB connector is the command source.

### ◆ Selection of command source in the network (NET) operation mode (Pr.550)

- Either of the RS-485 terminals or the communication option can be specified for the command source in the Network operation mode.
- For example, whether or not the communication option is installed, set **Pr.550** = "1" to write parameters or give the start and frequency commands via RS-485 terminals in the Network operation mode.

#### NOTE

- In the initial setting, "9999" (communication option automatic recognition) is set for **Pr.550**. Thus, if the communication option is mounted, parameters cannot be written or the start and frequency commands cannot be sent by communications that use the RS-485 terminals. (Monitoring or parameter reading can be performed.)

### ◆ Selection of the command source of the PU operation mode (Pr.551)

- Any of the PU connector, RS-485 terminals, or USB connector can be specified as the command source in the PU operation mode.
- To write parameters or execute the start and frequency commands through communication in the PU operation mode, set **Pr.551** = "1" for communication via the RS-485 terminals, or set **Pr.551** = "3" or "9999" for communication via the USB connector.

**NOTE**

- When **Pr.550** = "1" (NET mode RS-485 terminals) and **Pr.551** = "1" (PU mode RS-485 terminals), the PU operation mode has a precedence. For this reason, if the communication option is not mounted, switching to the Network operation mode is no longer possible.
- Changed setting values are enabled at power-ON or inverter reset.

Pr.550 setting	Pr.551 setting	Command source				Remarks
		PU connector	USB connector	RS-485 terminals	Communication option	
0	1	x	x	PU operation mode <sup>*1</sup>	NET operation mode <sup>*2</sup>	
	2	PU operation mode	x	x	NET operation mode <sup>*2</sup>	
	3	x	PU operation mode	x	NET operation mode <sup>*2</sup>	
	9999 (initial value)	PU operation mode <sup>*3</sup>	PU operation mode <sup>*3</sup>	x	NET operation mode <sup>*2</sup>	
1	1	x	x	PU operation mode <sup>*1</sup>	x	Switching to NET operation mode disabled
	2	PU operation mode	x	NET operation mode	x	
	3	x	PU operation mode	NET operation mode	x	
	9999 (initial value)	PU operation mode <sup>*3</sup>	PU operation mode <sup>*3</sup>	NET operation mode	x	
9999 (initial value)	1	x	x	PU operation mode <sup>*1</sup>	NET operation mode <sup>*2</sup>	
				x	NET operation mode <sup>*2</sup>	With communication option
	2	PU operation mode	x	NET operation mode	x	Without communication option
				x	NET operation mode <sup>*2</sup>	With communication option
	3	x	PU operation mode	NET operation mode	x	Without communication option
				x	NET operation mode <sup>*2</sup>	With communication option
9999 (initial value)	PU operation mode <sup>*3</sup>	PU operation mode <sup>*3</sup>	x	NET operation mode <sup>*2</sup>	With communication option	
			NET operation mode	x	Without communication option	

\*1 The MODBUS RTU protocol cannot be used in the PU operation mode. To use the MODBUS RTU protocol, set **Pr.551** = "2".  
 \*2 If the communication option is not mounted, switching to the NET operation mode is not possible.  
 \*3 When **Pr.551** = "9999", the priority of the PU command source is USB connector > PU connector.

## ◆ Controllability through communication

Command interface	Conditions (Pr.551 setting)	Item	Controllability in each operation mode					
			PU operation	External operation	Combined operation mode 1 (Pr.79 = "3")	Combined operation mode 2 (Pr.79 = "4")	NET operation (via RS-485 terminals) <sup>*7</sup>	NET operation (via option) <sup>*8</sup>
PU connector <sup>*1</sup>	2 (PU connector), 9999 (automatic recognition, without USB connection)	Operation (start) command	○	×	×	○	×	
		Operation (stop) command	○	Δ <sup>*4</sup>	Δ <sup>*4</sup>	○	Δ <sup>*4</sup>	
		Frequency setting	○	×	○	×	×	
		Monitor	○	○	○	○	○	
		Parameter write	○ <sup>*5</sup>	×	○ <sup>*5</sup>	○ <sup>*5</sup>	×	
		Parameter read	○	○	○	○	○	
		Inverter reset	○	○	○	○	○	
	Terminals other than the above	Operation (start) command	×	×	×	×	×	
		Operation (stop) command	Δ <sup>*4</sup>	Δ <sup>*4</sup>	Δ <sup>*4</sup>	Δ <sup>*4</sup>	Δ <sup>*4</sup>	
		Frequency setting	×	×	×	×	×	
		Monitor	○	○	○	○	○	
		Parameter write	×	×	×	×	×	
		Parameter read	○	○	○	○	○	
		Inverter reset	○	○	○	○	○	
RS-485 terminals	1 (RS-485 terminals)	Operation command (start, stop)	○	×	×	○	×	
		Frequency setting	○	×	○	×	×	
		Monitor	○	○	○	○	○	
		Parameter write	○ <sup>*5</sup>	×	○ <sup>*5</sup>	○ <sup>*5</sup>	×	
		Parameter read	○	○	○	○	○	
		Inverter reset	○	○	○	○	○	
	Terminals other than the above	Operation command (start, stop)	×	×	×	×	○ <sup>*2</sup>	×
		Frequency setting	×	×	×	×	○ <sup>*2</sup>	×
		Monitor	○	○	○	○	○	○
		Parameter write	×	×	×	×	○ <sup>*5</sup>	×
		Parameter read	○	○	○	○	○	○
		Inverter reset	×	×	×	×	○ <sup>*3</sup>	×
USB connector	3 (USB connector), 9999 (automatic recognition, with USB connection)	Operation command (start, stop)	○	×	×	○	×	
		Frequency setting	○	×	○	×	×	
		Monitor	○	○	○	○	○	
		Parameter write	○ <sup>*5</sup>	×	×	×	×	
		Parameter read	○	○	○	○	○	
		Inverter reset	○	○	○	○	○	
	Terminals other than the above	Operation command (start, stop)	×	×	×	×	×	
		Frequency setting	×	×	×	×	×	
		Monitor	○	○	○	○	○	
		Parameter write	×	×	×	×	×	
		Parameter read	○	○	○	○	○	
		Inverter reset	○	○	○	○	○	
Option	—	Operation command (start, stop)	×	×	×	×	×	○ <sup>*2</sup>
		Frequency setting	×	×	×	×	×	○ <sup>*2</sup>
		monitor	○	○	○	○	○	○
		Parameter write	×	×	×	×	×	○ <sup>*5</sup>
		Parameter read	○	○	○	○	○	○
		Inverter reset	×	×	×	×	×	○ <sup>*3</sup>

Command interface	Conditions (Pr.551 setting)	Item	Controllability in each operation mode					
			PU operation	External operation	Combined operation mode 1 (Pr.79 = "3")	Combined operation mode 2 (Pr.79 = "4")	NET operation (via RS-485 terminals) <sup>*7</sup>	NET operation (via option) <sup>*8</sup>
External control circuit terminal	—	Inverter reset	○	○	○	○	○	
		Operation command (start, stop)	×	○	○	×	×	×
		Frequency setting	×	○	×	○	×	×

○: Valid, ×: Invalid, Δ: Partially valid

\*1 RS-485 communication via PU connector

\*2 Follows the **Pr.338 Communication operation command source** and **Pr.339 Communication speed command source** settings. (Refer to page 400.)

\*3 At occurrence of RS-485 communication error, the inverter cannot be reset from the computer.

\*4 Only PU stop is enabled. "PS" is displayed on the operation panel during PU stop. The operation follows the **Pr.75 Reset selection/disconnected PU detection/PU stop selection** setting. (Refer to page 336.)

\*5 Writing of some parameters may be disabled by the **Pr.77 Parameter write selection** setting and the operating condition. (Refer to page 345.)

\*6 Some parameters are write-enabled independently of the operation mode and command source presence/absence. Writing is also enabled when **Pr.77 = "2"** (refer to page 345). Parameter clear is disabled.

\*7 When **Pr.550 NET mode operation command source selection = "1"** (RS-485 terminals enabled), or **Pr.550 NET mode operation command source selection = "9999"** with no communication option connected.

\*8 When **Pr.550 NET mode operation command source selection = "0"** (communication option enabled), or **Pr.550 NET mode operation command source selection = "9999"** with communication option connected.

## ◆ Operation when a communication error occurs

Fault type	Conditions (Pr.551 setting)	Operation in each operation mode at error occurrences					
		PU operation	External operation	Combined operation mode 1 (Pr.79 = "3")	Combined operation mode 2 (Pr.79 = "4")	NET operation (via RS-485 terminals) <sup>*5</sup>	NET operation (via option) <sup>*6</sup>
Inverter fault	—	Stop					
PU connector disconnection	2 (PU connector), 9999 (automatic recognition)	Stop/continued <sup>*1*4</sup>					
	Other than 2	Stop/continued <sup>*1</sup>					
Communication error at PU connector	2 (PU connector)	Stop/continued <sup>*2</sup>	Continued		Stop/continued <sup>*2</sup>	Continued	
	Other than 2	Continued					
Communication error at RS-485 terminals	1 (RS-485 terminals)	Stop/continued <sup>*2</sup>	Continued		Stop/continued <sup>*2</sup>	Continued	
	Other than 1	Continued				Stop/continued <sup>*2</sup>	Continued
Communication error at USB connector	3 (USB connector), 9999 (automatic recognition)	Stop/continued <sup>*2</sup>	Continued				
	Other than 3	Continued					
Communication error at communication option	—	Continued					Stop/continued <sup>*3</sup>

\*1 Selectable with **Pr.75 Reset selection/disconnected PU detection/PU stop selection**.

\*2 Selectable with **Pr.122 PU communication check time interval**, **Pr.336 RS-485 communication check time interval**, and **Pr.548 USB communication check time interval**.

\*3 The operation depends on the communication option setting.

\*4 In the PU JOG operation mode, operation always stops when the PU is disconnected. The operation at a PU disconnection fault (E.PUE) occurrence is as set in **Pr.75 Reset selection/disconnected PU detection/PU stop selection**.

\*5 When **Pr.550 NET mode operation command source selection = "1"** (RS-485 terminals enabled), or **Pr.550 NET mode operation command source selection = "9999"** with no communication option connected.

\*6 When **Pr.550 NET mode operation command source selection = "0"** (communication option enabled), or **Pr.550 NET mode operation command source selection = "9999"** with communication option connected.



## ◆ Selecting the command interface in the Network operation mode (Pr.338, Pr.339)

- Selecting a command interface is required for the following two types of commands: the operation command using the start signals and the signals related to the inverter function selection, and the speed command using signals related to the frequency setting.
- The following table shows the command interface for each function in the Network operation mode, determined by the parameter settings: an external terminal or a communication interface (RS-485 terminals or communication option).

Pr.338 Communication operation command source		0: NET			1: EXT			Remarks
Pr.339 Communication speed command source		0: NET	1: EXT	2: EXT	0: NET	1: EXT	2: EXT	
Frequency setting through communication		NET	—	NET	NET	—	NET	
Terminal 2		—	EXT	—	—	EXT	—	
Terminal 4		—	EXT	—	—	EXT	—	
Terminal 1		Compensation						
RL <sup>*1</sup>	Low-speed operation command/Remote setting (setting clear)/Stop-on-contact selection 0	NET	EXT		NET	EXT		Pr.59 = "0" (multi-speed), Pr.59 ≠ "0" (remote), Pr.270 = "1, 3, 11, or 13" (stop-on-contact)
RM <sup>*1</sup>	Middle-speed operation command/Remote setting (deceleration)	NET	EXT		NET	EXT		
RH <sup>*1</sup>	High-speed operation command/ Remote setting (acceleration)	NET	EXT		NET	EXT		
RT <sup>*1</sup>	Second function selection/ Stop-on-contact selection 1	NET			EXT			Pr.270 = "1, 3, 11, or 13" (stop-on-contact)
AU <sup>*1</sup>	Terminal 4 input selection	—	Combined		—	Combined		
JOG <sup>*1</sup>	Jog operation selection	—			EXT			
CS <sup>*1</sup>	Selection of automatic restart after instantaneous power failure / flying start	EXT or NET			EXT			EXT or NET is selected according to the setting in Pr.162. <sup>*2</sup>
OH <sup>*1</sup>	External thermal relay input	EXT						
REX <sup>*1</sup>	15-speed selection	NET	EXT		NET	EXT		Pr.59 = "0" (multi-speed)
X9 <sup>*1</sup>	Third function selection	NET			EXT			
X10 <sup>*1</sup>	Inverter run enable	EXT						
X11 <sup>*1</sup>	FR-HC2/FR-CC2 connection, instantaneous power failure detection	EXT						
X12 <sup>*1</sup>	PU operation external interlock	EXT						
X13 <sup>*1</sup>	External DC injection brake operation start	NET			EXT			
X14 <sup>*1</sup>	PID control valid	NET	EXT		NET	EXT		
BRI <sup>*1</sup>	Brake opening completion	NET			EXT			
X16 <sup>*1</sup>	PU/External operation switchover	EXT						
X17 <sup>*1</sup>	Load pattern selection forward/reverse rotation boost	NET			EXT			
X18 <sup>*1</sup>	V/F switchover	NET			EXT			
X19 <sup>*1</sup>	Load torque high-speed frequency	NET			EXT			
X20 <sup>*1</sup>	S-pattern acceleration/deceleration C switchover	NET			EXT			
X22 <sup>*1</sup>	Orientation command	NET			EXT			
LX <sup>*1</sup>	Pre-excitation/servo ON	NET			EXT			
MRS <sup>*1</sup>	Output stop	Combined			EXT			Pr.79 ≠ "7"
	PU operation interlock	EXT						Pr.79 = "7". When X12 signal is not assigned.
STP (STOP) <sup>*1</sup>	Start self-holding selection	—			EXT			
MC <sup>*1</sup>	Control mode switchover	NET			EXT			
TL <sup>*1</sup>	Torque limit selection	NET			EXT			
X28 <sup>*1</sup>	Start-time tuning start external input	NET			EXT			
X32 <sup>*1</sup>	External fault input	EXT						
X37 <sup>*1</sup>	Traverse function selection	NET			EXT			

Pr.338 Communication operation command source		0: NET			1: EXT			Remarks
Pr.339 Communication speed command source		0: NET	1: EXT	2: EXT	0: NET	1: EXT	2: EXT	
X42 <sup>*1</sup>	Torque bias selection 1	NET			EXT			
X43 <sup>*1</sup>	Torque bias selection 2	NET			EXT			
X44 <sup>*1</sup>	P/PI control switchover	NET			EXT			
BRI2 <sup>*1</sup>	Second brake sequence open completion	NET			EXT			
TRG <sup>*1</sup>	Trace trigger input	Combined			EXT			
TRC <sup>*1</sup>	Trace sampling start/end	Combined			EXT			
X48 <sup>*1</sup>	Power failure stop external	EXT						
SQ <sup>*1</sup>	Sequence start	EXT or NET*			EXT			Pr.414 = "1": Valid when there is EXT or NET input. Pr.414 = "2": EXT
X51 <sup>*1</sup>	Fault clear	Combined			EXT			
X52 <sup>*1</sup>	Cumulative pulse monitor clear	NET			EXT			
X53 <sup>*1</sup>	Cumulative pulse monitor clear (control terminal option)	NET			EXT			
JOGF <sup>*1</sup>	JOG forward rotation command	—			EXT			
JOGR <sup>*1</sup>	JOG reverse rotation command	—			EXT			
CLRN <sup>*1</sup>	NET position pulse clear	NET						
STF <sup>*1</sup>	Forward rotation command	NET			EXT			
STR <sup>*1</sup>	Reverse rotation command	NET			EXT			
RES <sup>*1</sup>	Inverter reset	EXT						
X64 <sup>*1</sup>	PID forward/reverse action switchover	NET	EXT		NET	EXT		
X65 <sup>*1</sup>	PU/NET operation switchover	EXT						
X66 <sup>*1</sup>	External/NET operation switchover	EXT						
X67 <sup>*1</sup>	Command source switchover	EXT						
NP <sup>*1</sup>	Simple position pulse train sign	EXT						
CLR <sup>*1</sup>	Simple position droop pulse clear	EXT						
X70 <sup>*1</sup>	DC feeding operation permission signal	NET			EXT			
X71 <sup>*1</sup>	DC feeding cancel signal	NET			EXT			
X72 <sup>*1</sup>	PID P control switchover	NET	EXT		NET	EXT		
X73 <sup>*1</sup>	Second PID P control switchover	NET	EXT		NET	External		
X74 <sup>*1</sup>	Magnetic flux decay output shutoff	NET			EXT			
X76 <sup>*1</sup>	Proximity dog	EXT						
X77 <sup>*1</sup>	Pre-charge end command	NET	EXT		NET	EXT		
X78 <sup>*1</sup>	Second pre-charge end command	NET	EXT		NET	EXT		
X79 <sup>*1</sup>	Second PID forward/reverse action switchover	NET	EXT		NET	EXT		
X80 <sup>*1</sup>	Second PID control valid	NET	EXT		NET	EXT		
X85 <sup>*1</sup>	SSCNET III communication disabled	EXT						
X87 <sup>*1</sup>	Sudden stop	Combined			EXT			
LSP <sup>*1</sup>	Forward stroke end	EXT						
LSN <sup>*1</sup>	Reverse stroke end	EXT						
X92 <sup>*1</sup>	Emergency stop	EXT						
X93 <sup>*1</sup>	Torque control selection	NET			EXT			
X94 <sup>*1</sup>	Control signal input for main circuit power supply MC	EXT						
X95 <sup>*1</sup>	Converter unit fault input	EXT						
X96 <sup>*1</sup>	Converter unit fault (E.OHT, E.CPU) input	EXT						
RLF <sup>*1</sup>	Low-speed forward rotation command	—			—	EXT		
RLR <sup>*1</sup>	Low-speed reverse rotation command	—			—	EXT		

\*1 Use Pr.178 to Pr.189 (Input terminal function selection) to assign the function to an input terminal. (Refer to page 521.)

\*2 When Pr.77 = "2", Pr.162 setting can be changed during operation. The new setting is applied after stop. Until the inverter has stopped, the previous setting of the interface for the operation command and the speed command in the Network operation mode is valid.

[Explanation of Terms in Table]

EXT: External terminal only

NET: Communication interface only

Combined: Either external terminal or communication interface

—: Neither external terminal nor communication interface

Compensation: Only commands given via the external terminal are valid when **Pr.28 Multi-speed input compensation selection** = "1".

**NOTE**

- The communication interface selection is determined by the setting of **Pr.550** and **Pr.551**.
- The setting of **Pr.338** and **Pr.339** can be changed during operation when **Pr.77** = "2". Note that the changed setting is applied after the inverter has stopped. Until the inverter has stopped, the previous setting of the interface for the operation command and the speed command in the Network operation mode is valid.

### ◆ Changing the command interface using a signal input via external terminal (X67 signal)

- In the Network operation mode, the command interface for the operation command and the speed command can be changed using the Command source switchover (X67) signal. This method may be useful to use both external terminal and communication interface by using a different interface according to the command type.
- For the X67 signal, set "67" to any of **Pr.178 to Pr.189 (Input terminal function selection)** to assign the function to a control terminal.
- When the X67 signal is OFF, the command interface for the operation command and the speed command is the control terminal.

X67 signal state	Interface for the operation command	Interface for the speed command
Signal not assigned	Determined by <b>Pr.338</b> setting	Determined by <b>Pr.339</b> setting
ON		
OFF	Control terminal only	

**NOTE**

- The ON/OFF state of the X67 signal is applied only during a stop. When the terminals are switched during operation, the ON/OFF state is reflected after a stop.
- When the X67 is OFF, a reset via communication is disabled.
- Changing the terminal assignment using **Pr.178 to Pr.189 (Input terminal function selection)** may affect the other functions. Set parameters after confirming the function of each terminal.

◀◀ **Parameters referred to** ▶▶

**Pr.28 Multi-speed input compensation selection**  page 411

**Pr.59 Remote function selection**  page 367

**Pr.79 Operation mode selection**  page 389

## 5.9.4 Reverse rotation prevention selection

This function can prevent reverse rotation fault resulting from the incorrect input of the start signal.

Pr.	Name	Initial value	Setting range	Description
<b>78</b> <b>D020</b>	<b>Reverse rotation prevention selection</b>	0	0	Both forward and reverse rotations allowed
			1	Reverse rotation disabled
			2	Forward rotation disabled

- Set this parameter to limit the motor rotation to only one direction.
- This parameter is valid for all of the reverse rotation and forward rotation keys of the operation panel and of the parameter unit, the start signals (STF, STR signals) via external terminals, and the forward and reverse rotation commands through communication.

## 5.9.5 Frequency setting using pulse train input

A pulse train input via terminal JOG can be used to set the inverter's speed command.

Moreover, speed synchronized operation of an inverter can be performed by using the pulse train input and output together.

Pr.	Name	Initial value		Setting range	Description	
		FM	CA		Pulse train input (terminal JOG)	Pulse train output (terminal FM)
291 D100	Pulse train I/O selection	0		0	JOG signal <sup>*1</sup>	FM output <sup>*2</sup>
				1	Pulse train input	FM output <sup>*2</sup>
				10 <sup>*2</sup>	JOG signal <sup>*1</sup>	High-speed pulse train output (50% duty)
				11 <sup>*2</sup>	Pulse train input	High-speed pulse train output (50% duty)
				20 <sup>*2</sup>	JOG signal <sup>*1</sup>	High-speed pulse train output (ON width fixed)
				21 <sup>*2</sup>	Pulse train input	High-speed pulse train output (ON width fixed)
				100 <sup>*2</sup>	Pulse train input	High-speed pulse train output (ON width fixed). Output the pulse train input without changes.
384 D101	Input pulse division scaling factor	0		0	Pulse train input disabled	
				1 to 250	Division ratio on the input pulse. The frequency resolution on the input pulse changes according to this setting.	
385 D110	Frequency for zero input pulse	0 Hz		0 to 590 Hz	Set the frequency applicable to the time when the input pulse is zero (bias).	
386 D111	Frequency for maximum input pulse	60 Hz	50 Hz	0 to 590 Hz	Set the frequency applicable to the time when the input pulse is maximum (gain).	

\*1 Function assigned to Pr.185 JOG terminal function selection.

\*2 Valid only for the FM type inverters.

## ◆ Selection of pulse train input (Pr.291)

- Setting Pr.291 Pulse train I/O selection = "1, 11, 21, or 100" and Pr.384 Input pulse division scaling factor ≠ "0" allows the function of terminal JOG to change into a pulse train input for setting of the inverter frequency. In the initial setting, the JOG signal is assigned to terminal JOG. A maximum pulse train of 100k pulses/s can be input.
- Connection with an open collector output system pulse generator

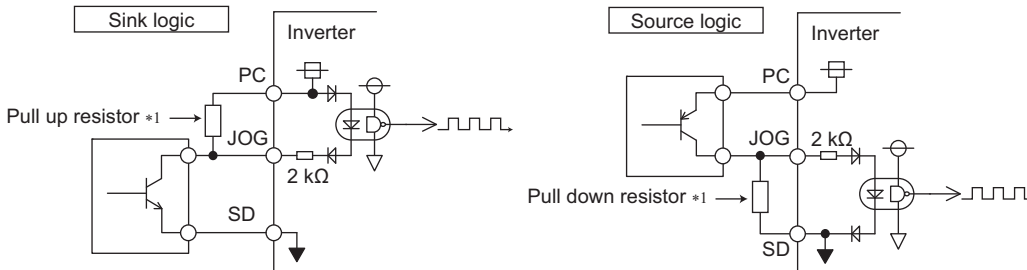

\*1 When the wiring length is long with open collector outputs, the influence of stray capacitance causes the pulse to flatten out and prevents the input pulse from being recognized.

When the wiring length is long (10 m or longer of shielded twisted pair cable with a recommended cable gauge of 0.75 mm<sup>2</sup>), connect the open collector output signal to the power supply by an external pull-up resistor. The following table shows the reference resistance values for wiring length. The stray capacitance of the wiring changes considerably according to how the cable is laid, thus the above wiring lengths are not guaranteed values. When using a pull-up/down resistor, check the permissible power of the resistor and the permissible load current of the output transistor, and use within the permissible range.

Wiring length	Less than 10 m	10 to 50 m	50 to 100 m
Pull-up/down resistor	Not required	1 kΩ	470 Ω
Load current (reference)	10 mA	35 mA	65 mA

- Connection with a complementary output system pulse generator

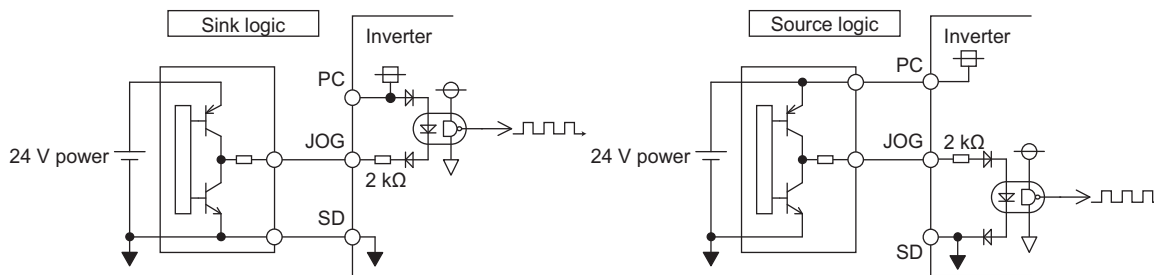

### NOTE

- When pulse train input is selected, the function assigned to terminal JOG by **Pr.185 JOG terminal function selection** is invalid.
- When "2" (simple position pulse train command given by pulse train input) is set to **Pr.419 Position command source selection**, the JOG terminal becomes the simple position pulse train terminal regarding of the **Pr.291** setting.
- **Pr.291** is the selection parameter for pulse train output/FM output. Thus, before changing the setting, check the specifications of the device connected to the terminal FM. (For the pulse train output, refer to [page 461](#).)

## ◆ Pulse train input specification

Item	Specification	
Supported pulse method	Open collector output / complementary output (24 V power supply voltage)	
HIGH input level	20 V or more (voltage between JOG and SD)	
LOW input level	5 V or less (voltage between JOG and SD)	
Maximum input pulse rate	100k pulses/s	
Minimum input pulse width	2.5 μs	
Input resistance/load current	2 kΩ (typ) / 10 mA (typ)	
Maximum wiring length (reference value)	Open collector output method	10 m (0.75 mm <sup>2</sup> /twisted pair)
	Complementary output method	100 m (output resistance 50 Ω) <sup>*1</sup>
Detection resolution	1/3750	

\*1 The wiring length of complementary output is dependent on the output wiring specification of the complementary output unit. The stray capacitance of the wiring changes considerably according to how the cable is laid, so the maximum wiring length is not a guaranteed value.

## ◆ Adjustment of pulse train and frequency (Pr.385, Pr.386)

- The frequency during zero input pulse and maximum input pulse can be set with **Pr.385 Frequency for zero input pulse** and **Pr.386 Frequency for maximum input pulse**, respectively.

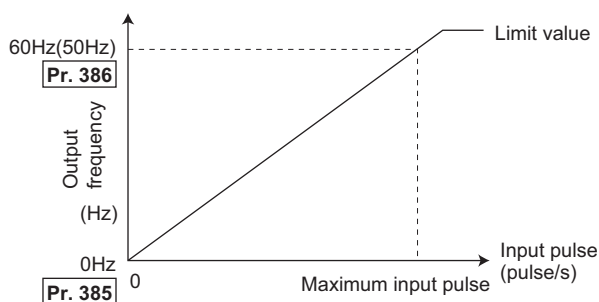

\*1 Limit value = (Pr.386 - Pr.385) × 1.1 + Pr.385

## ◆ How to calculate the input pulse division scaling factor (Pr.384)

The maximum number of input pulses can be calculated by the following formula with **Pr.384 Input pulse division scaling factor**:

Maximum number of pulses (pulse/s) = **Pr.384** × 400 (maximum 100k pulses/s)

(number of detectable pulses = 11.45 pulses/s)

For example, to run the invert at 0 Hz when pulse train input is zero and at 30 Hz when pulse train is 4000 pulses/sec, set the inverter as follows:

**Pr.384** = "10" (maximum number of input pulses 4000 pulses/s)

Pr.385 = 0 Hz, Pr.386 = 30 Hz (pulse train limit value 33 Hz)

**NOTE**

- The priority of the frequency command given by the external signals is as follows: JOG operation > multi-speed operation > terminal 4 analog input > pulse train input. When pulse train input is enabled (Pr.291 = "1, 11, 21, or 100" and Pr.384 ≠ "0"), terminal 2 analog input becomes disabled.

**◆ Speed synchronized operation by pulse input/output**

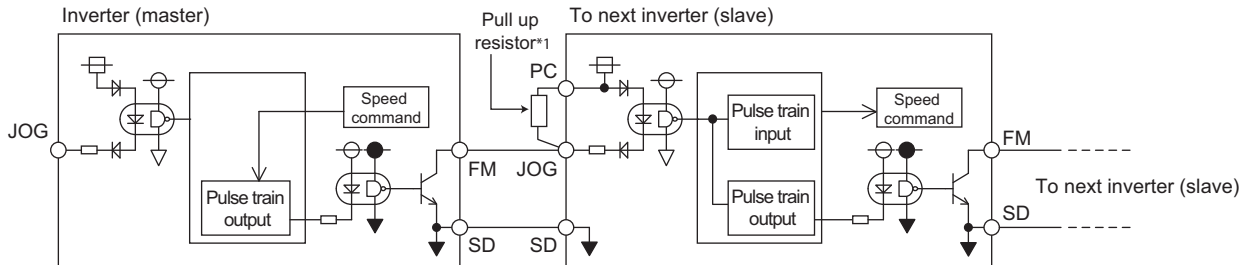

\*1 When the wiring length between FM and JOG is long, the influence of stray capacitance causes the pulse to flatten out and prevents the input pulse from being recognized. When the wiring length is long (10 m or longer of shielded twisted pair cable with a recommended cable size of 0.75 mm<sup>2</sup>), connect between terminal JOG and terminal PC with an external pull-up resistor. The following table shows the reference resistance values for wiring length.

Wiring length	Less than 10 m	10 to 50 m	50 to 100 m
Pull-up resistor	Not required	1 kΩ	470 Ω
Load current (reference)	10 mA	35 mA	65 mA

The stray capacitance of the wiring changes considerably according to how the cable is laid, thus the above wiring lengths are not guaranteed values.

When using a pull-up/down resistor, check the permissible power of the resistor and the permissible load current (terminal PC: 100 mA, high-speed pulse train output: 85 mA), and use within the permissible range.

- Setting "100" in Pr.291 allows the use of the entire pulse train input for the pulse train output (via terminal FM) just as they are.

Connecting in a daisy chain enables speed synchronized operation of multiple inverters.

- Set Pr.384 to "125" for inverters that receive pulse train since the maximum pulse train output is 50k pulses/s.
- The maximum number of input pulses should be 50k pulses/s.
- When performing synchronized operation, wire according to the following procedure. (This is to prevent contact input of 24 V being applied to terminal FM.)

1. Set pulse train output (setting other than "0 or 1") to Pr.291 on the master side inverter.
2. Inverter power OFF
3. Wire the slave side terminal JOG-SD to the master side terminal FM-SD.
4. Turn the inverter power supply ON.

**NOTE**

- After changing the Pr.291 setting, connect the JOG terminal to the terminal FM-SD. When FM output (voltage output) is taken as the pulse train, take caution to prevent voltage from being applied to the terminal FM.
- Use sink logic (factory setting) for the slave side inverter. The inverter does not operate properly with source logic.

**◆ Speed synchronized operation specification**

Item	Specification
Output pulse format	Pulse width fixed (10 μs)
Pulse rate	0 to 50k pulses/s
Pulse propagation delay	1 to 2 μs per unit*1

\*1 A pulse propagation delay of about 1 to 2 μs in the slave occurs and further increases when the wiring length is long.

Parameters referred to

Pr.291 (Pulse train output) page 457

Pr.419 Position command source selection page 319

## 5.9.6 JOG operation

The frequency and acceleration/deceleration time for JOG operation can be set. JOG operation is possible in both External operation and PU.

JOG operation can be used for conveyor positioning, test operation, etc.

Pr.	Name	Initial value	Setting range	Description
<b>15</b> <b>D200</b>	<b>Jog frequency</b>	5 Hz	0 to 590 Hz	Set the frequency for JOG operation.
<b>16</b> <b>F002</b>	<b>Jog acceleration/ deceleration time</b>	0.5 s	0 to 3600 s	Set the motor acceleration/deceleration time during JOG operation. For the acceleration/deceleration time, set the time until the frequency*1 set in <b>Pr.20 Acceleration/deceleration reference frequency</b> is reached. The acceleration/deceleration times cannot be set separately.

Note that these parameters are categorized as a simple mode parameter when the LCD operation panel (FR-LU08) or the parameter unit (FR-PU07) is used. Setting of this parameter is enabled when the operation panel (FR-DU08) is connected and "0" is set to **Pr.160 User group read selection**. (Refer to [page 354](#).)

\*1 The **Pr.20** initial value is set to 60 Hz for the FM type and to 50 Hz for the CA type.

### ◆ JOG operation using the external signals

- Operation can be started and stopped by the start signals (STF and STR signals) when the Jog operation selection (JOG) signal is ON. (For the operation method, refer to [page 162](#).)
- While the JOGF or JOGR signal is input, Jog frequency setting (**Pr.15**) is used for operation. The rotation is forward while the JOGF signal is input, and the rotation is reverse while the JOGR signal is input. (Direct JOG function)
- Use the JOG acceleration/deceleration time function (**Pr.16**) to set the acceleration/deceleration time for JOG operation.
- To use each signal, set the corresponding number selected from the following table in any of **Pr.178 to Pr.189 (Input terminal function selection)** to assign the function to an output terminal.

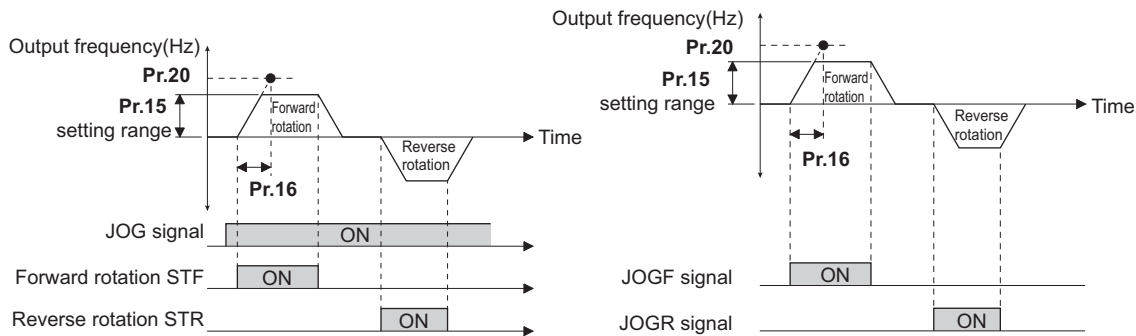

Input signal	Pr.178 to Pr.189 settings
JOG	5 ( <b>Pr.185</b> initial value)
JOGF	57
JOGR	58



### ◆ JOG operation using the PU

- When the operation panel or parameter unit is in the JOG operation mode, the motor jogs only while the start button is pressed. (For the operation method, refer to [page 163](#).)

## NOTE

- The reference frequency during acceleration/deceleration depends on the **Pr.29 Acceleration/deceleration pattern selection** setting. (Refer to [page 372](#).)
- The **Pr.15** setting should be equal to or higher than the **Pr.13 Starting frequency** setting.
- The JOG signal can be assigned to an input terminal by setting **Pr.178 to Pr.189 (Input terminal function selection)**. Changing the terminal assignment may affect other functions. Set parameters after confirming the function of each terminal.
- During JOG operation, the second acceleration/deceleration function using the RT signal is disabled. (Other second functions are enabled (refer to [page 525](#).)
- When the JOGR or STR signal is input while the JOGF signal is input, the motor is decelerated to stop.
- When the JOGF or STF signal is input while the JOGR signal is input, the motor is decelerated to stop.
- The three-wire type connection is not available for the JOGF and JOGR signals.
- When **Pr.79 Operation mode selection** = "4", JOG operation is started by one push of  /  on the operation panel and stopped by .
- This function is invalid when **Pr.79** = "3".
- Under the position control, when the position command speed creation is completed and the droop pulse is within in-position width, the external JOG operation can be operated. (The JOG operation cannot be performed from PU.)
- To perform the JOG operation using the external signals, select the setting of "JOG signal" for the input via terminal JOG in **Pr.291 Pulse train I/O selection**. (Refer to [page 406](#).)

### Parameters referred to

Pr.13 Starting frequency [page 381](#)

Pr.20 Acceleration/deceleration reference frequency, Pr.21 Acceleration/deceleration time increments [page 367](#)

Pr.29 Acceleration/deceleration pattern selection [page 372](#)

Pr.79 Operation mode selection [page 389](#)

Pr.178 to Pr.189 (Input terminal function selection) [page 521](#)

## 5.9.7 Operation by multi-speed setting

Use these parameters to change among pre-set operation speeds with the terminals. The speeds are pre-set with parameters.



Any speed can be selected by simply turning ON/OFF the contact signals (RH, RM, RL, and REX signals).

Pr.	Name	Initial value		Setting range	Description
		FM	CA		
28 D300	Multi-speed input compensation selection	0		0	Without compensation
				1	With compensation
4 D301	Multi-speed setting (high speed)	60 Hz	50 Hz	0 to 590 Hz	Sets the frequency when RH is ON.
5 D302	Multi-speed setting (middle speed)	30 Hz		0 to 590 Hz	Sets the frequency when RM is ON.
6 D303	Multi-speed setting (low speed)	10 Hz		0 to 590 Hz	Sets the frequency when RL is ON.
24 D304	Multi-speed setting (speed 4)	9999		0 to 590 Hz, 9999	Frequency from 4th speed to 15th speed can be set according to the combination of the RH, RM, RL and REX signals. 9999: Not selected
25 D305	Multi-speed setting (speed 5)				
26 D306	Multi-speed setting (speed 6)				
27 D307	Multi-speed setting (speed 7)				
232 D308	Multi-speed setting (speed 8)				
233 D309	Multi-speed setting (speed 9)				
234 D310	Multi-speed setting (speed 10)				
235 D311	Multi-speed setting (speed 11)				
236 D312	Multi-speed setting (speed 12)				
237 D313	Multi-speed setting (speed 13)				
238 D314	Multi-speed setting (speed 14)				
239 D315	Multi-speed setting (speed 15)				

### ◆ Multi-speed setting (Pr.4 to Pr.6)

- The inverter operates at frequencies set in **Pr.4** when the RH signal is ON, **Pr.5** when the RM signal is ON, or **Pr.6** when the RL signal is ON.

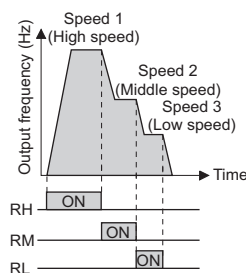
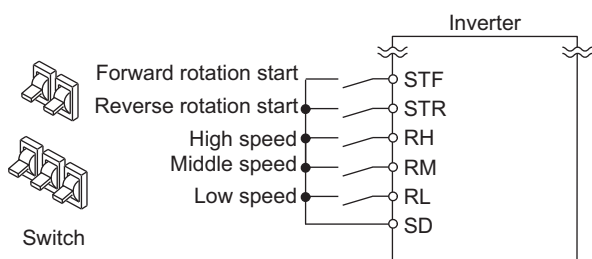

#### NOTE

- In the initial setting, if two or more speed switches (signals) are simultaneously turned ON, priority is given to the switch (signal) for the lower speed. For example, when both RH and RM signals turn ON, the RM signal (**Pr.5**) has the higher priority.
- The RH, RM and RL signals are assigned to the terminals RH, RM and RL, respectively, in the initial status. To assign each signal to a different terminal, set "0" (RL signal), "1" (RM signal), or "2" (RH signal) in any of **Pr.178 to Pr.189 (Input terminal function selection)**.

### ◆ Multi-speed setting for 4th speed or more (Pr.24 to Pr.27, Pr.232 to Pr.239)

- The frequency from 4th speed to 15th speed can be set according to the combination of the RH, RM, RL, and REX signals. Set the running frequencies in **Pr.24 to Pr.27, Pr.232 to Pr.239**. (In the initial status, 4th to 15th speeds are invalid.)

- For the terminal used for REX signal input, set "8" in any of **Pr.178 to Pr.189 (Input terminal function selection)** to assign the function.

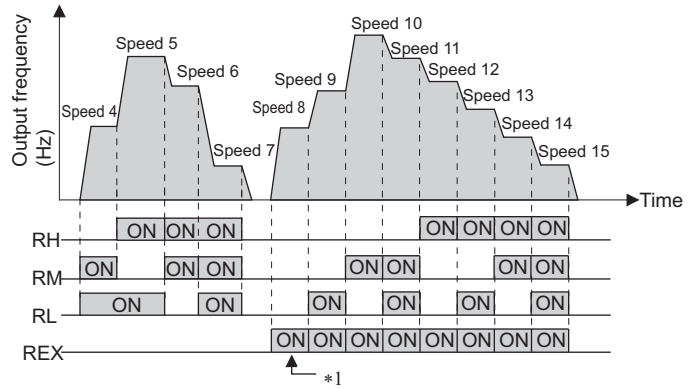
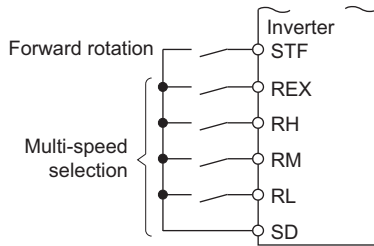

\*1 When the RH, RM and RL signals are OFF and the REX signal is ON while "9999" is set to **Pr.232 Multi-speed setting (speed 8)**, the inverter operates at the frequency set in **Pr.6**.

### ◆ Direct multi-speed setting

- While the RLF or RLR signal is input, the operation is according to **Pr.6 Multi-speed setting (low-speed)**. The rotation is forward while the RLF signal is input, and the rotation is reverse while the RLR signal is input.

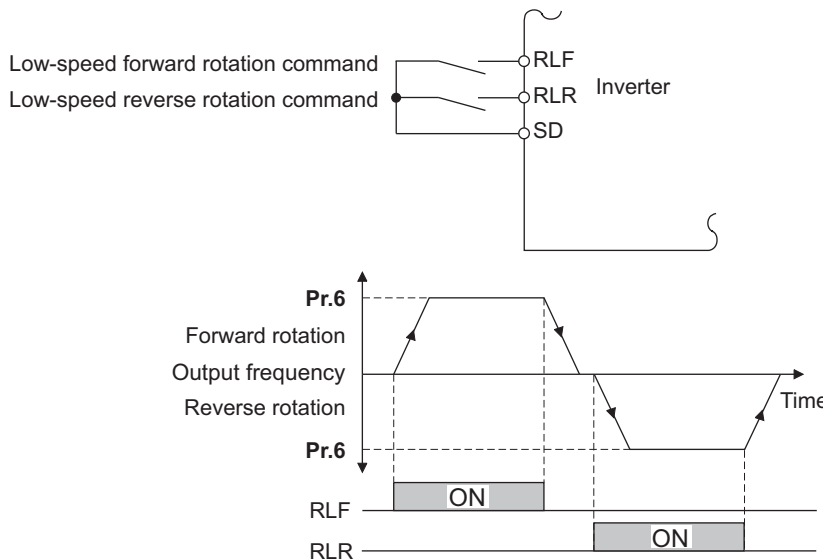

#### NOTE

- The **Pr.6** setting should be equal to or higher than the **Pr.13 Starting frequency** setting.
- To assign the RLF and RLR signals to input terminals, set "128 (RLF)" and "129 (RLR)" in any two parameters from **Pr.178 to Pr.189 (Input terminal function selection)**.
- The direct multi-speed operation is enabled when the inverter operates in External operation mode or External/PU combined operation mode 1.
- When the RLR or STR signal is input while the RLF signal is input, the motor is decelerated to stop.
- When the RLF or STF signal is input while the RLR signal is input, the motor is decelerated to stop.
- When **Pr.59 Remote function selection** ≠ "0", the RLF signal is used as the STF signal, and the RLR signal is used as the STR signal.
- When the stop-on-contact function is enabled, the RLF signal is used as the STF signal, and the RLR signal is used as the STR signal.

### ◆ Input compensation of multi-speed setting (Pr.28)

- Speed (frequency) can be compensated for the multi-speed setting and the remote setting by inputting the frequency setting compensation signal (terminals 1, 2).

**NOTE**

- The priority of the frequency commands given by the external signals is as follows: JOG operation > multi-speed operation > terminal 4 analog input > pulse train input > terminal 2 analog input. (For details on frequency commands given by analog input, refer to [page 505](#).)
- The input compensation of multi-speed setting is enabled when the inverter is in the External operation mode or PU/External combined operation mode (**Pr.79** = "3 or 4").
- Multi-speed parameters can also be set during PU operation or External operation.
- The **Pr.24 to Pr.27 and Pr.232 to Pr.239** settings have no priority among them.
- When **Pr.59 Remote function selection** ≠ "0", the multi-speed setting is invalid since the RH, RM, and RL signals are for remote setting.
- When performing analog input compensation, set **Pr.28 Multi-speed input compensation selection** to "1".
- Select the terminals (terminals 1, 2) to use for compensation input voltage (0 to ± 5 V, 0 to ± 10 V) at **Pr.73 Analog input selection**.
- When using terminal 1 for compensation input, set **Pr.868 Terminal 1 function assignment** = "0 (initial value)".
- Changing the terminal assignment using **Pr.178 to Pr.189 (Input terminal function selection)** may affect the other functions. Set parameters after confirming the function of each terminal.

**Parameters referred to**

**Pr.15 Jog frequency** [page 410](#)

**Pr.59 Remote function selection** [page 377](#)

**Pr.73 Analog input selection** [page 496](#)

**Pr.79 Operation mode selection** [page 389](#)

**Pr.178 to Pr.189 (Input terminal function selection)** [page 521](#)

**Pr.868 Terminal 1 function assignment** [page 500](#)

## 5.10 (H) Protective function parameter

Purpose	Parameter to set		Refer to page
To protect the motor from overheating	Electronic thermal O/L relay	P.H000, P.H006, P.H010, P.H016, P.H020 to P.H022	Pr.9, Pr.51, Pr.561, Pr.607, Pr.608, Pr.876, Pr.1016 415
To set the overheat protection characteristics for the motor	Free thermal O/L relay	P.H001 to P.H005, P.H011 to P.H015	Pr.600 to Pr.604, Pr.692 to Pr.696 422
To decelerate and stop when the motor thermal protection is activated	Fault definition	P.H030	Pr.875 422
To extend the life of the cooling fan	Cooling fan operation selection	P.H100	Pr.244 423
To detect an earth (ground) fault at start	Earth (ground) fault detection at start	P.H101	Pr.249 425
To vary the operating level of the undervoltage protective function	Undervoltage level	P.H102	Pr.598 425
To initiate an inverter protective function	Fault initiation	P.H103	Pr.997 425
To disable the I/O phase loss protective function	I/O phase loss	P.H200, P.H201	Pr.251, Pr.872 426
To restart using the retry function when the protective function is activated	Retry operation	P.H300 to P.H303	Pr.65, Pr.67 to Pr.69 426
To set the upper and lower limits of the output frequency	Maximum/minimum frequency	P.H400 to P.H402	Pr.1, Pr.2, Pr.18 428
To prevent the motor from overspeeding under torque control	Speed limit	P.H410 to P.H412	Pr.807 to Pr.809 287
To avoid overdriving the motor during speed control	Overdriving prevention	P.H415 to P.H417	Pr.285 to Pr.853, Pr.873 269
To operate avoiding resonance points	Frequency jump	P.H420 to P.H425, P.H429	Pr.31 to Pr.36, Pr.552 429
To limit the output current so that the inverter protective function does not activate	Stall prevention	P.H500, P.H501, P.H600 to P.H603, P.H610, P.H611, P.H620, P.H621, P.H631, P.M430, P.T010, P.T040	Pr.22, Pr.23, Pr.48, Pr.49, Pr.66, Pr.114, Pr.115, Pr.148, Pr.149, Pr.154, Pr.156, Pr.157, Pr.858, Pr.868 431
To limit the torque during speed control	Torque limit	P.H500, P.H700 to P.H704, P.H710, P.H720, P.H721, P.H730, P.T010, P.T040, P.G210	Pr.22, Pr.801, Pr.803, Pr.810, Pr.812 to Pr.817, Pr.858, Pr.868, Pr.874 245
To monitor for load faults	Load characteristics fault detection	P.H520 to P.H527, P.H531 to P.H535	Pr.1480 to Pr.1492 439
To shut off output if the operation panel disconnects	Overspeed detection level	P.H800	Pr.374 443
To shut off output if the operation panel disconnects	Deceleration check	P.H881	Pr.690 270

### 5.10.1 Motor overheat protection (electronic thermal O/L relay)

Set the current of the electronic thermal relay function to protect the motor from overheating. Such settings provide the optimum protective characteristic considering the low cooling capability of the motor during low-speed operation.

Pr.	Name	Initial value	Setting range	Description
9 H000	Electronic thermal O/L relay	Inverter rated current <sup>*1</sup>	0 to 500 A <sup>*2</sup>	Set the rated motor current.
			0 to 3600 A <sup>*3</sup>	
600 H001	First free thermal reduction frequency 1	9999	0 to 590 Hz 9999	The electronic thermal O/L relay operation level can be changed to match the motor temperature characteristics with the combination of these three points ( <b>Pr.600</b> , <b>Pr.601</b> ), ( <b>Pr.602</b> , <b>Pr.603</b> ), ( <b>Pr.604</b> , <b>Pr.9</b> ). 9999: Free thermal O/L relay invalid
601 H002	First free thermal reduction ratio 1	100%	1 to 100% 9999	
602 H003	First free thermal reduction frequency 2	9999	0 to 590 Hz 9999	
603 H004	First free thermal reduction ratio 2	100%	1 to 100% 9999	
604 H005	First free thermal reduction frequency 3	9999	0 to 590 Hz 9999	
607 H006	Motor permissible load level	150%	110 to 250%	
51 H010	Second electronic thermal O/L relay	9999	0 to 500 A <sup>*2</sup>	Enabled when the RT signal is ON.
			0 to 3600 A <sup>*3</sup>	Set the rated motor current.
			9999	Second electronic thermal O/L relay invalid
692 H011	Second free thermal reduction frequency 1	9999	0 to 590 Hz 9999	The electronic thermal O/L relay operation level can be changed to match the second motor temperature characteristics with the combination of these three points ( <b>Pr.692</b> , <b>Pr.693</b> ), ( <b>Pr.694</b> , <b>Pr.695</b> ), ( <b>Pr.696</b> , <b>Pr.51</b> ) when the RT signal is ON. 9999: Second free thermal O/L relay invalid
693 H012	Second free thermal reduction ratio 1	100%	1 to 100% 9999	
694 H013	Second free thermal reduction frequency 2	9999	0 to 590 Hz 9999	
695 H014	Second free thermal reduction ratio 2	100%	1 to 100% 9999	
696 H015	Second free thermal reduction frequency 3	9999	0 to 590 Hz 9999	
608 H016	Second motor permissible load level	9999	110 to 250%	Set the permissible frequency when the RT signal is ON.
			9999	The <b>Pr.607</b> setting is applied even when the RT signal is ON.
561 H020	PTC thermistor protection level	9999	0.5 to 30 kΩ	Set the PTC thermistor protection level (resistance).
			9999	PTC thermistor protection disabled
1016 H021	PTC thermistor protection detection time	0 s	0 to 60 s	Set the time from when the resistance of the PTC thermistor reaches the protection level until the protective function is activated.
876 H022 <sup>*4</sup>	Thermal protector input	1	0	Terminal OH of the control terminal option (FR-A8TP) is invalid.
			1	Terminal OH of the control terminal option (FR-A8TP) is valid.

\*1 The initial value for the FR-A820-00077(0.75K) or lower and FR-A840-00038(0.75K) or lower is set to the 85% of the inverter rated current.

\*2 The setting range of the FR-A820-03160(55K) or lower and the FR-A840-01800(55K) or lower The minimum setting increment is 0.01 A.

\*3 The setting range of the FR-A820-03800(75K) or higher and the FR-A840-02160(75K) or higher The minimum setting increment is 0.1 A.

\*4 The setting is available when the FR-A8TP is installed.

## ◆ Electronic thermal O/L relay operation characteristic for induction motor (Pr.9)

- This function detects the overload (overheat) of the motor and shut off the inverter output by stopping the operation of the transistor at the inverter output side.
- Set the rated current (A) of the motor in **Pr.9 Electronic thermal O/L relay**. (If the motor has both 50 Hz and 60 Hz ratings and the **Pr.3 Base frequency** is set to 60 Hz, set to 1.1 times the 60 Hz rated motor current.)
- Set "0" in **Pr.9** to avoid activating the electronic thermal relay function; for example, when using an external thermal relay for the motor.

(Note that the output transistor protection of the inverter is activated. (E.THT))

- When using the Mitsubishi Electric constant-torque motor, set **Pr.71 Applied motor** = "1, 13 to 16, 50, 53, 54". (This setting enables the 100% constant-torque characteristic in the low-speed range.)

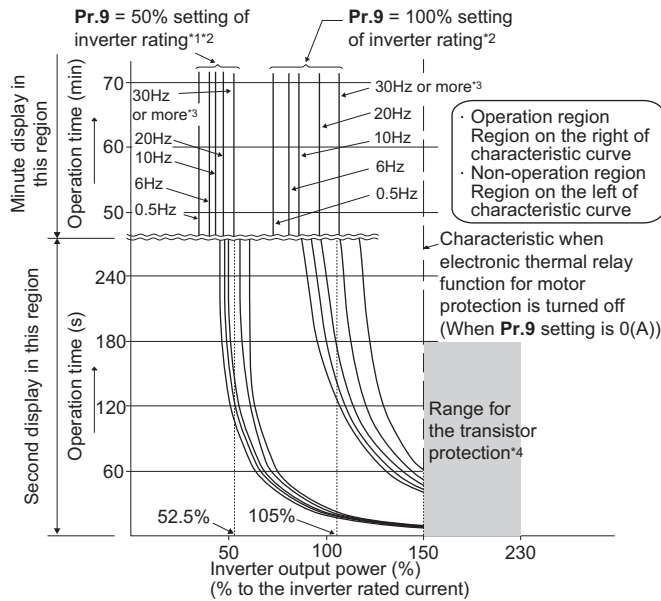

\*1 When setting **Pr.9** to a value (current value) of 50% of the inverter rated current

\*2 The % value denotes the percentage to the rated inverter current. It is not the percentage to the rated motor current.

\*3 When you set the electronic thermal relay function dedicated to the Mitsubishi Electric constant-torque motor, this characteristic curve applies to operation at 6 Hz or higher. (For selection of the operation characteristic, refer to [page 528](#).)

\*4 Transistor protection is activated depending on the temperature of the heat sink. The protection may be activated even with less than 150% depending on the operating conditions.

## NOTE

- The internal accumulated heat value of the electronic thermal relay function is reset to the initial value by the inverter's power reset or reset signal input. Avoid unnecessary reset and power-OFF.
- Install an external thermal relay (OCR) between the inverter and motors to operate several motors, a multi-pole motor or a dedicated motor with one inverter. When setting an external thermal relay, note that the current indicated on the motor rating plate is affected by the line-to-line leakage current. (Refer to [page 116](#).) The cooling effect of the motor drops during low-speed operation. Use a thermal protector or a motor with built-in thermistor.
- The protective characteristic of the electronic thermal O/L relay is degraded when there is a large difference in capacity between the inverter and motor, and when the set value is small. In such case, use an external thermal relay.
- A dedicated motor cannot be protected by an electronic thermal O/L relay. Use an external thermal relay.
- Set **Pr.9** = "0" for Vector-control-dedicated motors (SF-V5RU) because they are equipped with thermal protectors.
- The transistor protection thermal O/L relay is activated early when the **Pr.72 PWM frequency selection** setting is increased.

## ◆ Electronic thermal O/L relay when using IPM motor (Pr.9)

- This function detects the overload (overheat) of the motor and shut off the inverter output by stopping the operation of the transistor at the inverter output side.
- Set the rated current (A) of the motor in **Pr.9 Electronic thermal O/L relay**. Performing IPM parameter initialization automatically sets the rated current of the IPM motor. (Refer to [page 231](#).)
- Set "0" in **Pr.9** to avoid activating the electronic thermal relay function; for example, when using an external thermal relay for the motor.

(Note that the output transistor protection of the inverter is activated. (E.THT))

- Operational characteristic of the electronic thermal O/L relay when MM-CF is used.

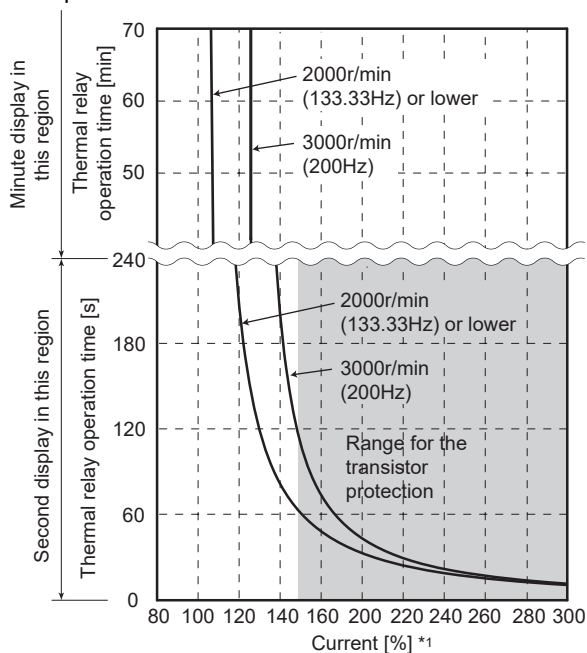

Protective function activated area: the area right of the characteristic curve

Normal operation area: the area left of the characteristic curve

\*1 The % value denotes the percentage to the rated motor current.

**NOTE**

- The internal accumulated heat value of the electronic thermal relay function is reset to the initial value by the inverter's power reset or reset signal input. Avoid unnecessary reset and power-OFF.
- When using a PM motor other than MM-CF, set the free thermal parameters (Pr.600 to Pr.604) in accordance with the motor characteristic.
- The transistor protection thermal O/L relay is activated early when the Pr.72 PWM frequency selection setting is increased.

**◆ Set two types of electronic thermal O/L relays (Pr.51)**

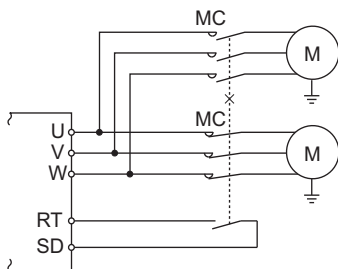

- These settings are used when rotating two motors with different rated current separately by a single inverter. (When rotating two motors together, use an external thermal relay.)
- Set the rated motor current for the second motor in Pr.51 Second electronic thermal O/L relay.

- While the RT signal is ON, the setting values of **Pr.51** is referred to provide thermal protection.

Pr.450 Second applied motor	Pr.9 Electronic thermal O/L relay	Pr.51 Second electronic thermal O/L relay	RT signal OFF		RT signal ON	
			First motor	Second monitor	First motor	Second monitor
9999	0	9999	×	×	×	×
		0	×	×	×	×
		0.01 to 500 (0.1 to 3600)	×	Δ	×	○
9999	Other than 0	9999	○	×	○	×
		0	○	×	Δ	×
		0.01 to 500 (0.1 to 3600)	○	Δ	Δ	○
Other than 9999	0	9999	×	×	×	×
		0	×	×	×	×
		0.01 to 500 (0.1 to 3600)	×	Δ	×	○
Other than 9999	Other than 0	9999	○	Δ	Δ	○
		0	○	×	Δ	×
		0.01 to 500 (0.1 to 3600)	○	Δ	Δ	○

○: Values are accumulated by using the output current.  
 Δ: Values are accumulated by assuming the output current is 0 A (cooling processing).  
 ×: Electronic thermal O/L relay does not operate.

**NOTE**

- The RT signal is the Second function selection signal. The RT signal also enables other second functions. (Refer to [page 525](#).)
- The RT signal is assigned to the terminal RT in the initial status. Set "3" in one of **Pr.178 to Pr.189 (Input terminal function selection)** to assign the RT signal to another terminal.

**◆ Acceleration time setting (Pr.607, Pr.608)**

The electronic thermal O/L relay operation characteristic can be changed by setting the permissible load level according to the motor characteristics.

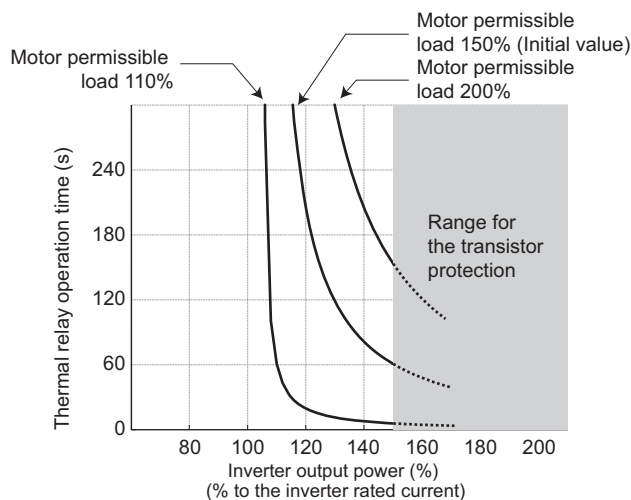

Example of motor permissible load setting (when Pr.9="100% of the inverter rating")

**◆ Electronic thermal O/L relay pre-alarm (TH) and warning signal (THP signal)**

- If the accumulated electronic thermal value reaches 85% of the **Pr.9** or **Pr.51** setting, electronic thermal O/L relay function pre-alarm (TH) is displayed and the electronic thermal O/L relay pre-alarm (THP) signal is output. If the value reaches 100% of the **Pr.9** setting, the motor thermal protection (E.THM/E.THT) is activated to shut off the inverter output. The inverter output is not shut off with the TH display.



- For the terminal used for the THP signal output, assign the function by setting "8 (positive logic) or 108 (negative logic)" in any of **Pr.190 to Pr.196 (Output terminal function selection)**.

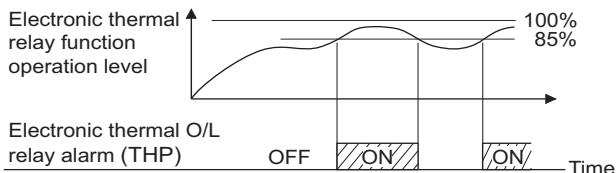

**NOTE**

- Changing the terminal assignment using **Pr.190 to Pr.196 (Output terminal function selection)** may affect the other functions. Set parameters after confirming the function of each terminal.

## ◆ External thermal relay input (OH signal, E.OHT)

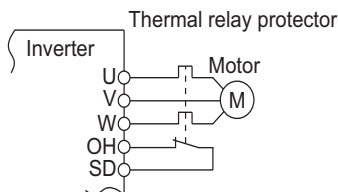

External thermal relay input connection diagram

- The External thermal relay input (OH) signal is used when using the external thermal relay or the thermal protector built into the motor to protect the motor from overheating.
- When the thermal relay is activated, the inverter output is shut off by the external thermal relay (E.OHT).
- For the terminal used for the OH signal input, set "7" in any of **Pr.178 to Pr.189 (Input terminal function selection)** to assign the function.
- Vector-control-dedicated motors (SF-V5RU) are equipped with thermal protectors.

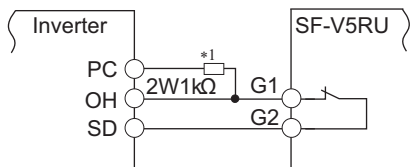

### Connecting the SF-V5RU thermal protector

\*1 Connect the recommended 2 W 1 kΩ resistor between terminals PC and OH. (Refer to [page 91](#).)

- When the control terminal option (FR-A8TP) is used, valid/invalid setting of the terminal OH can be changed using **Pr.876 thermal protector input**.

**NOTE**

- Changing the terminal assignment using **Pr.178 to Pr.189 (Input terminal function selection)** may affect the other functions. Set parameters after confirming the function of each terminal.

## ◆ PTC thermistor input (Pr.561, Pr.1016, E.PTC)

This function is used to protect the motor from overheating by inputting outputs from the motor's built-in PTC thermistor to the inverter. It is recommended that a PTC thermistor whose resistance increases most rapidly around the rated activating temperature ( $TN \pm DT$ ) is used.

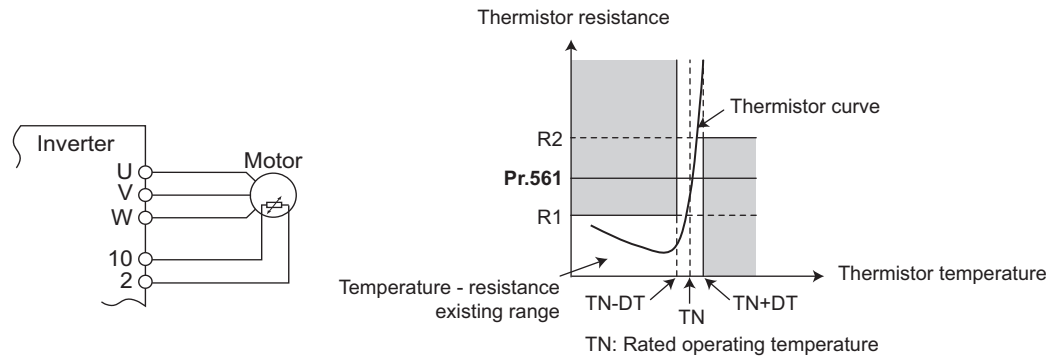

PTC thermistor input connection diagram

Example of PTC thermistor characteristics

- Output from the PTC thermistor, which is built into the motor, can be input to terminals 2 and 10. If the input from the PTC thermistor reaches the resistor value set in **Pr.561 PTC thermistor protection level**, the PTC thermistor operation (E.PTC) shuts off the inverter output.
- To use the PTC thermistor input function, select voltage input (initial setting) for terminal 2 using the voltage/current input selection switch. (For details on the voltage/current input switch assembly, refer to [page 496](#).)
- Confirm the characteristic of the PTC thermistor to be used, and set the resistance for **Pr.561** around the center of the  $R1$  and  $R2$  values shown on the figure above so that it does not deviate from the protective function activating temperature  $TN$ . If the **Pr.561** setting becomes too close to  $R1$  or  $R2$ , the protective function activating temperature may be too hot (protection is delayed), or too cold (too much protection).
- When the PTC thermistor protection is enabled (**Pr.561**  $\neq$  "9999"), the resistance value for the PTC thermistor can be displayed on the operation panel or via RS-485 communication. (Refer to [page 446](#).)
- When the PTC thermistor protection level setting is used, use **Pr.1016 PTC thermistor protection detection time** to set the time from when the resistance of the PTC thermistor reaches the protection level until the protective function (E.PTC) is activated.
- If the resistance of the PTC thermistor falls below the protection level within the protection detection time, the elapsed time count is cleared.

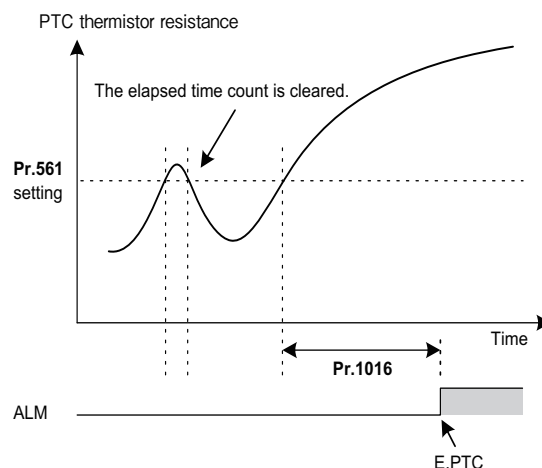

**NOTE**

- When using terminal 2 for PTC thermistor input (**Pr.561** ≠ "9999"), the terminal 2 does not operate as an analog frequency command terminal. The PID and dancer control functions assigned to the terminal 2 is also disabled. Use **Pr.133 PID** action set point to set the set point for the PID function.
- To input power to the PTC thermistor power supply, always use the terminal 10 and do not use any other terminals or an external power supply. Otherwise, the PTC thermistor protection (E.PTC) does not operate properly.
- When E.PTC is activated, the alarm display, "External protection (AU terminal)", may appear on the parameter unit (FR-PU07), but it is not a fault.

**◆ Overheat protection to match the characteristic of the motor (Pr.600 to Pr.604, Pr.692 to Pr.696)**

- The activation level of the electronic thermal O/L relay can be varied to match the motor temperature characteristic.
- The electronic thermal O/L relay operation level can be set with the combination of three points (**Pr.600, Pr.601**), (**Pr.602, Pr.603**), (**Pr.604, Pr.9**). Two or more points are required for setting.
- The electronic thermal O/L relay operation level can be set with the combination of three points (**Pr.692, Pr.693**), (**Pr.694, Pr.695**), (**Pr.696, Pr.51**) when the RT signal is ON.

Continuous operation characteristic

Load ratio (ratio to **Pr.9 (Pr.51)**) [%]

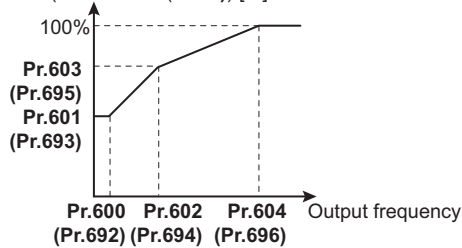

Setting example 1

- Pr.9**=100% of the rated motor current
- Pr.600**=6Hz
- Pr.601**=50%
- Pr.602**=30Hz
- Pr.603**=70%
- Pr.604**=60Hz

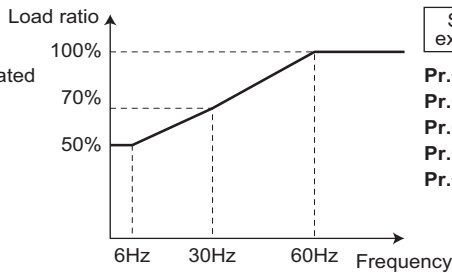

Setting example 2

- Pr.600**=120Hz
- Pr.601**=60%
- Pr.602**=3Hz
- Pr.603**=50%
- Pr.604**=60Hz

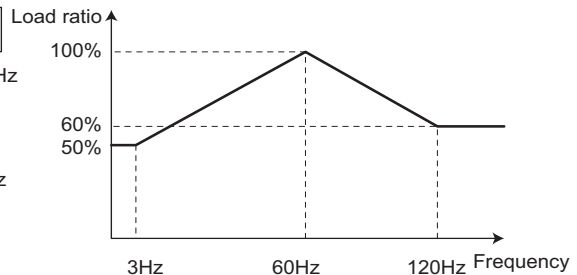

- When setting **Pr.600, Pr.602, and Pr.604 (Pr.692, Pr.694, and Pr.696)** to the same frequency, the graph shows a step plot.

Load ratio [%]

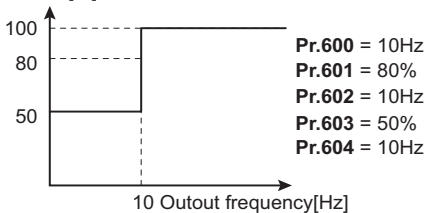

- Pr.600** = 10Hz
- Pr.601** = 80%
- Pr.602** = 10Hz
- Pr.603** = 50%
- Pr.604** = 10Hz

**NOTE**

- Make sure to set the parameters according to the temperature characteristic of the motor used.

◀ Parameters referred to ▶

- Pr.71 Applied motor** [page 528](#)
- Pr.72 PWM frequency selection** [page 356](#)
- Pr.178 to Pr.189 (Input terminal function selection)** [page 521](#)
- Pr.190 to Pr.196 (Output terminal function selection)** [page 473](#)

**5.10.2 Fault definition**

Fault output can be done after deceleration stop when motor thermal protection is activated.

Pr.	Name	Initial value	Setting range	Description
875 H030	Fault definition	0	0	Normal operation
			1	Decelerates to stop at activation of motor thermal protection.

### ◆ Output shutoff at activation of any protective function (Pr.875 = "0" initial value)

- At activation of a protective function, output is shutoff, and the alarm output 2 signal (ER) and the fault signal (ALM) are output.

### ◆ Deceleration stop at motor thermal protection activation (Pr.875 = "1")

- At activation of the external thermal relay (E.OHT), motor load (electronic thermal O/L relay) (E.THM) and PTC thermistor (E.PTC) protective functions, the alarm output 2 (ER) signal is displayed, and the motor decelerates to stop. After it stops, a fault signal (ALM) is output.
- When the ER signal comes ON, reduce the load or take other measures to allow the inverter to decelerate.
- During fault occurrence aside from the E.OHT, THM and E.PTC, the output is immediately shut off, and the fault signal (ALM) is output.
- To use the ER signal, set "97 (positive logic)" or "197 (negative logic)" in any of **Pr.190 to Pr.196 (Output terminal function selection)** to assign the function to the output terminal.

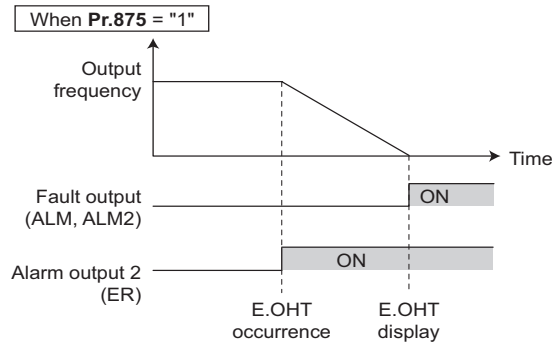

#### NOTE

- Regardless of the **Pr.875** setting, when the protective function is operating during position control, output is immediately shut off. (No deceleration stop)
- For systems with a large load-side torque that prevents deceleration, setting value "0" is recommended.
- Changing the terminal assignment using **Pr.190 to Pr.196 (Output terminal function selection)** may affect the other functions. Set parameters after confirming the function of each terminal.

#### Parameters referred to

Pr.190 to Pr.196 (Output terminal function selection) [page 473](#)

## 5.10.3 Cooling fan operation selection

A cooling fan is built into the inverter and its operation can be controlled.

Pr.	Name	Initial value	Setting range	Description
244	Cooling fan operation selection	1	0	Cooling fan ON/OFF control is invalid. (The cooling fan is always ON at power ON) A cooling fan operates at power ON.
			1	Cooling fan ON/OFF control enabled. The fan is always ON while the inverter is running. During a stop, the inverter status is monitored and the fan switches ON/OFF according to the temperature.
			101 to 105	Cooling fan ON/OFF control enabled. Set the cooling fan stop delay time within 1 to 5 seconds.
			1000	Cooling fan ON/OFF control is invalid. (The cooling fan is always ON at power ON) A cooling fan operates at power ON.
			1001	Cooling fan ON/OFF control enabled. The fan is always ON while the inverter is running. During a stop, the inverter status is monitored and the fan switches ON/OFF according to the temperature.
			1101 to 1105	Cooling fan ON/OFF control enabled. Set the cooling fan stop delay time within 1 to 5 seconds.
H100	Cooling fan operation selection	1	0	Cooling fan ON/OFF control is invalid. (The cooling fan is always ON at power ON) A cooling fan operates at power ON.
			1	Cooling fan ON/OFF control enabled. The fan is always ON while the inverter is running. During a stop, the inverter status is monitored and the fan switches ON/OFF according to the temperature.
			101 to 105	Cooling fan ON/OFF control enabled. Set the cooling fan stop delay time within 1 to 5 seconds.
H106	Cooling fan operation selection during the test operation	0	0	The cooling fan operates according to the <b>H100</b> setting during Vector control test operation or PM sensorless vector control test operation.
			1	The cooling fan can be set to always OFF during Vector control test operation or PM sensorless vector control test operation.

### ◆ Cooling fan always ON (Pr.244 = "0")

- When **Pr.244** = "0", the cooling fan operates at power ON. If the fan stops at this time, the inverter finds that the fan operation is faulty and "F A" (FN), the indication of the Fan alarm, is displayed on the operation panel. The Fan fault output (FAN) signal and the Alarm (LF) signal are output.
- For the terminal used for the FAN signal output, set "25 (positive logic)" or "125 (negative logic)" in any of **Pr.190 to Pr.196 (Output terminal function selection)** and for LF signal, set "98 (positive logic)" or "198 (negative logic)".

### ◆ Cooling fan operation control (Pr.244 (P.H100) = "1" (initial value), "101 to 105")

- The cooling fan operation is controlled when **Pr.244** = "1". When the inverter is running, the cooling fan operates constantly. When the inverter is stopped, the cooling fan operates depending on the temperature of the inverter heat sink. If the fan stops although it meets the conditions for running, fan operation is regarded as faulty, [FN] is displayed on the operation panel, and the fan signal and LF signals are output.
- To prevent the cooling fan from turning ON and OFF repeatedly during frequent starts/stops (inching), the cooling fan stop waiting time can be set. The waiting time when **Pr.244** = "101 to 105" is **Pr.244** - 100 (or 1 second, if the **Pr.244** = "101").

### ◆ Cooling fan operation command (Y206) signal

- The Cooling fan operation command (Y206) signal can be output when the inverter cooling fan meets the conditions for running. The function can be used when the fan installed on the enclosure is synchronized with the inverter cooling fan.
- The Y206 signal indicates the operating command condition of the inverter cooling fan depending on the power supply ON/OFF or the **Pr.244** settings. The signal does not indicate the actual operation of the cooling fan. (The signal is output even if the cooling fan is stopped due to a fault.)
- To use the Y206 signal, set "206 (positive logic) or 306 (negative logic)" in one of **Pr.190 to Pr.196 (Output terminal function selection)** to assign function to an output terminal.

## ◆ Cooling fan operation selection during the test operation (Pr.244 = "1000, 1001, 1101 to 1105" (P.H106 = "1"))

- When P.H106 = "1" or Pr.244 = "1000, 1001, or 1101 to 1105", the cooling fan can be set to always OFF during Vector control test operation or PM sensorless vector control test operation.

### NOTE

- The cooling fan is installed on the FR-A820-00105(1.5K) or higher and the FR-A840-00083(2.2K) or higher.
- Changing the terminal assignment using Pr.190 to Pr.196 (Output terminal function selection) may affect the other functions. Set parameters after confirming the function of each terminal.

### Parameters referred to

Pr.190 to Pr.196 (Output terminal function selection)  page 473

## 5.10.4 Earth (ground) fault detection at start



Select whether to make earth (ground) fault detection at start. When enabled, earth (ground) fault detection is performed immediately after a start signal input to the inverter.

Pr.	Name	Initial value	Setting range	Description
249 H101	Earth (ground) fault detection at start	0	0	Without the earth (ground) fault detection at start
			1	With the earth (ground) fault detection at start

- If a ground fault is detected at start while Pr.249 = "1", the output-side earth (ground) fault overcurrent (E.GF) is displayed and the outputs are shut off. (Refer to page 790.)
- Pr.249 setting is enabled during V/F control and Advanced magnetic flux vector control.
- When the Pr.72 PWM frequency selection setting is high, enable the ground fault detection at start.

### NOTE

- Because the detection is performed at start, output is delayed for approx. 20 ms every start.
- Use Pr.249 to enable/disable ground fault detection at operation start. Ground faults are detected always during operation regardless of the Pr.249 setting.

## 5.10.5 Varying the activation level of the undervoltage protective function

If the undervoltage protection (E.UVT) activates due to unstable voltage in the power supply, the undervoltage level (DC bus voltage value) can be changed.

Pr.	Name	Initial value	Setting range	Description
598 H102	Undervoltage level	9999	175 to 215 VDC <sup>*1</sup>	Set the DC voltage value at which E.UVT occurs.
			350 to 430 VDC <sup>*2</sup>	
			9999	E.UVT occurs at 215 VDC (200 V class) / 430 VDC (400 V class).

\*1 For the 200 V class

\*2 For the 400 V class

### NOTE

- Do not use this function when switching to an external battery, since the inrush current when power is restored increases, as the undervoltage level is decreased.
- For the 200 V class inverters, the setting is available for the FR-A820-02330(45K) or lower.
- The Pr.598 setting is valid for induction motors. When either of the first or second motor is a PM motor, the Pr.598 setting is invalid.

## 5.10.6 Initiating a protective function

A fault (protective function) is initiated by setting the parameter.

This function can be used to check how the system operates at activation of a protective function.

Pr.	Name	Initial value	Setting range	Description
997 H103	Fault initiation	9999	16 to 253	The setting range is same with the one for fault data codes of the inverter (which can be read through communication). Written data is not stored in EEPROM.
			9999	The read value is always "9999". The protective function is not activated with this setting.

- To initiate a fault (protective function), set the assigned number of the protective function to be initiated in **Pr.997**.
- The value set in **Pr.997** is not stored in EEPROM.
- When a protective function activates, the inverter output is shut off, a fault is displayed, and a fault signal (ALM, ALM2) is output.
- The latest fault in the fault history is displayed while the fault initiation function is in operation. After a reset, the fault history goes back to the previous status. (The protective function generated by the fault is not saved in the fault history.)
- Perform inverter reset to cancel the protective function.
- For the selectable parameter by **Pr.997** and the corresponding protective functions, refer to [page 776](#).

**NOTE**

- If a protective function is already operating, no fault can be activated by **Pr.997**.
- The retry function is disabled when a protective function has been initiated by the fault initiation function.
- If a fault occurs after a protective function has been activated, the protective function indication does not change. The fault is not saved in the fault history either.

## 5.10.7 I/O phase loss protection selection

The output phase loss protection function, which stops the inverter output if one of the three phases (U, V, W) on the inverter's output side (load side) is lost, can be disabled.

The input phase loss protective function on the inverter input side (R/L1, S/L2, T/L3) can be enabled.

Pr.	Name	Initial value	Setting range	Description
251 H200	Output phase loss protection selection	1	0	Output phase loss protection disabled
			1	Output phase loss protection enabled
872 H201 <sup>*1</sup>	Input phase loss protection selection	0	0	Input phase loss protection disabled
			1	Input phase loss protection enabled

\*1 The setting is available for the standard structure model and the IP55 compatible model.

### ◆ Output phase loss protection selection (Pr.251)

- When **Pr.251** is set to "0", output phase loss protection (E.LF) becomes invalid.

### ◆ Input phase loss protection selection (Pr.872) (Standard models and IP55 compatible models)

- When **Pr.872** is set to "1", Input phase loss (E.ILF) protection is activated if one of three phases is lost for 1 second.

**NOTE**

- When several motors are connected, output phase loss cannot be detected even if the wiring to one motor loses phase.
- If an input phase is lost while **Pr.872** = "1" (with input phase loss protection), **Pr.261 Power failure stop selection** ≠ "0" (power failure stop function enabled), the motor decelerates to stop without outputting E.ILF.
- In the case of R/L1, S/L2 phase loss, the input phase loss protection does not operate, and the inverter output is shut off.
- If an input phase loss continues for a long time, the lives of converter section and capacitor of the inverter become shorter.

« Parameters referred to »

**Pr.261 Power failure stop selection** [page 642](#)

## 5.10.8 Retry function

This function allows the inverter to reset itself and restart at activation of the protective function (fault indication). The retry generating protective functions can also be selected.

When the automatic restart after instantaneous power failure function is selected (**Pr.57 Restart coasting time**  $\neq$  9999), the restart operation is also performed after a retry operation as well as after an instantaneous power failure. (For restart operation, refer to [page 628](#) and [page 635](#) for selection.)

Pr.	Name	Initial value	Setting range	Description
<b>65</b> <b>H300</b>	<b>Retry selection</b>	0	0 to 5	Faults which trigger the retry operation can be selected.
<b>67</b> <b>H301</b>	<b>Number of retries at fault occurrence</b>	0	0	The retry function disabled.
			1 to 10	Set the number of retries at a fault occurrence. A fault output is not provided during the retry operation.
			101 to 110	Set the number of retries at a fault occurrence. (The setting value minus 100 is the number of retries.) A fault output is provided during the retry operation.
<b>68</b> <b>H302</b>	<b>Retry waiting time</b>	1 s	0.1 to 600 s	Set the time delay from when an inverter fault occurs until the retry operation starts.
<b>69</b> <b>H303</b>	<b>Retry count display erase</b>	0	0	Setting "0" clears the retry success counter ("retry success" means that the inverter successfully restarts).

### ◆ Setting the retry function (Pr.67, Pr.68)

- When the inverter protective function is operating (fault indication), the retry function automatically cancels (resets) the protective function after the time set in **Pr.68**. The retry function then restarts the operation from the starting frequency.
- The retry function is enabled when the **Pr.67** setting is other than "0". Set the number of retries at activation of the protective function in **Pr.67**.

Pr.67 setting	Fault output during retry operation	Retry count
0	—	No retry function
1 to 10	Not available	1 to 10 times
101 to 110	Available	1 to 10 times

- When retries fail consecutively more than the number of times set in **Pr.67**, a retry count excess (E.RET) occurs, resulting in an inverter retries. (Refer to the Retry failure example.)
- Use **Pr.68** to set the waiting time from a protective function activation to a retry in the range of 0.1 to 600 seconds.
- During retry operation, the During retry (Y64) signal is ON. For the Y64 signal, set "64 (positive logic)" or "164 (negative logic)" in any of **Pr.190 to Pr.196 (Output terminal function selection)** to assign the function.

### ◆ Retry count check (Pr.69)

- Reading the **Pr.69** value provides the cumulative number of successful restart times made by retries. The cumulative count in **Pr.69** increases by 1 when a retry is successful. Retry is regarded as successful when normal operation continues without a fault for the **Pr.68** setting multiplied by four or longer (3.1 seconds at the shortest). (When retry is successful, the cumulative number of retry failures is cleared.)
- Writing "0" in **Pr.69** clears the cumulative count.

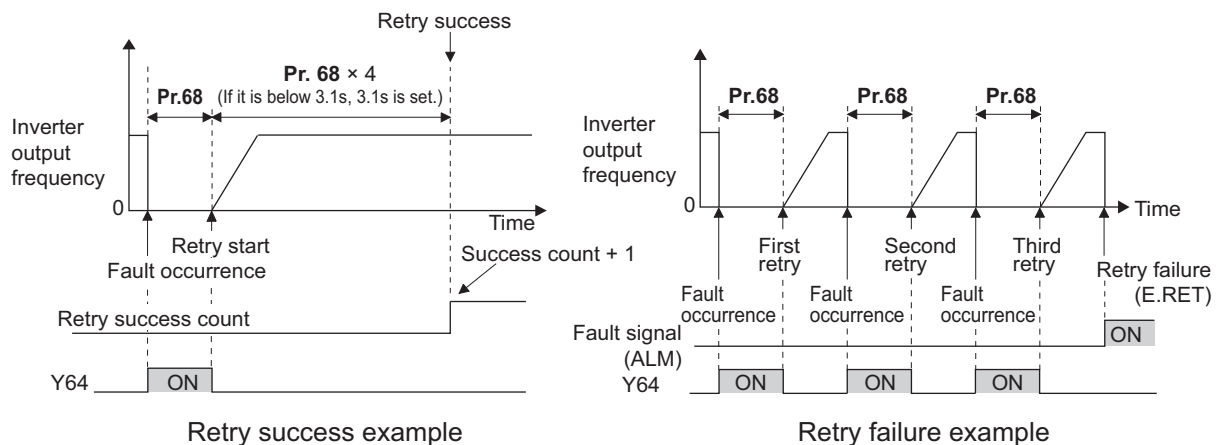



## ◆ Selecting retry generating faults (Pr.65)

- Using Pr.65, the fault that causes a retry is selectable. No retry is made for the fault not indicated. (For the fault details, refer to [page 779](#).) • indicates the faults selected for retry.

Retry-making fault	Pr.65 setting					
	0	1	2	3	4	5
E.OC1	•	•		•	•	•
E.OC2	•	•		•	•	
E.OC3	•	•		•	•	•
E.OV1	•		•	•	•	
E.OV2	•		•	•	•	
E.OV3	•		•	•	•	
E.THM	•					
E.THT	•					
E.IPF	•				•	
E.UVT	•				•	
E. BE	•				•	
E. GF	•				•	
E.OHT	•					
E.OLT	•				•	
E.OPT	•				•	
E.OP1	•				•	
E. PE	•				•	
E.MB1	•				•	
E.MB2	•				•	

Retry-making fault	Pr.65 setting					
	0	1	2	3	4	5
E.MB3	•				•	
E.MB4	•				•	
E.MB5	•				•	
E.MB6	•				•	
E.MB7	•				•	
E.OS	•				•	
E.OSD	•				•	
E.PTC	•					
E.CDO	•				•	
E.SER	•				•	
E.USB	•				•	
E.ILF	•				•	
E.PID	•				•	
E.PCH	•				•	
E.SOT	•	•		•	•	•
E.LCI	•				•	
E.LUP	•				•	
E.LDN	•				•	

### NOTE

- Use the retry function only when the operation can be resumed after resetting a protective function activation. Making a retry against the protective function, which is activated by an unknown condition, will lead the inverter and motor to be faulty. Identify and remove the cause of the protective function activation before restarting the operation.
- If the retry function operates during PU operations, the operating conditions (forward/reverse rotation) are stored; and operations resume after retry reset.
- Only the fault details for the first fault that occurred during retry are stored in the fault history.
- The reset by the retry function does not clear the accumulated data of the electronic thermal O/L relay, regenerative brake duty, etc. (This is different from power supply reset or reset by RES signal.)
- When the parameter storage device fault (E.PE) is occurring and reading of the retry-function-related parameters is not possible, retry cannot be operated.
- Changing the terminal assignment using Pr.190 to Pr.196 (Output terminal function selection) may affect the other functions. Set parameters after confirming the function of each terminal.

### ⚠ CAUTION

- When the retry function is set enabled, stay away from the motor and machine in the case of an output shutoff. The motor and machine will start suddenly (after the reset time has elapsed) after the shutoff. When the retry function is selected, apply the supplied CAUTION stickers to easily visible places.

#### Parameters referred to

Pr.57 Restart coasting time [page 628](#), [page 635](#)

## 5.10.9 Limiting the output frequency (maximum/minimum frequency)

Motor speed can be limited. Clamp the upper and lower limits of the output frequency.

Pr.	Name	Initial value	Setting range	Description
1 H400	Maximum frequency	120 Hz <sup>*1</sup>	0 to 120 Hz	Set the upper limit of the output frequency.
		60 Hz <sup>*2</sup>		
2 H401	Minimum frequency	0 Hz	0 to 120 Hz	Set the lower limit of the output frequency.
18 H402	High speed maximum frequency	120 Hz <sup>*1</sup>	0 to 590 Hz	Set when operating at 120 Hz or higher.
		60 Hz <sup>*2</sup>		

\*1 For the FR-A820-03160(55K) or lower, and FR-A840-01800(55K) or lower.

\*2 For the FR-A820-03800(75K) or higher, and FR-A840-02160(75K) or higher.

## ◆ Setting the maximum frequency (Pr.1, Pr.18)

- Set **Pr.1 Maximum frequency** to the upper limit of the output frequency. If the value of the frequency command given is higher than the setting, the output frequency is clamped at the maximum frequency.
- To operate at a frequency higher than the 120 Hz, adjust the upper output frequency limit with **Pr.18 High speed maximum frequency**. (When setting a frequency in **Pr.18**, the **Pr.1** setting automatically changes to the frequency set in **Pr.18**. Also, when setting a frequency in **Pr.1**, the **Pr.18** setting automatically changes to the frequency set in **Pr.1**.)

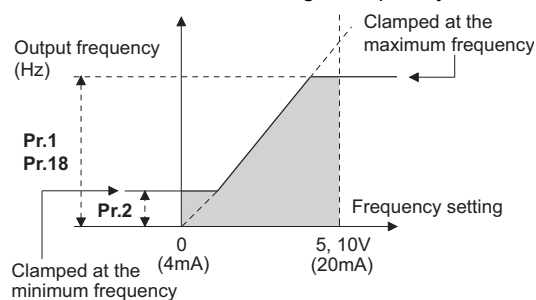

## ◆ Setting the minimum frequency (Pr.2)

- Set **Pr.2 Minimum frequency** to the lower limit of the output frequency.
- If the set frequency is **Pr.2** or less, the output frequency is clamped at **Pr.2** (does not fall below **Pr.2**).

### NOTE

- To operate with a frequency higher than 60 Hz using frequency-setting analog signals, change the **Pr.125 (Pr.126) (frequency setting gain)** setting. Simply changing the **Pr.1** and **Pr.18** settings does not enable the operation at a frequency higher than 60 Hz.
- During Real sensorless vector control, Vector control, and PM sensorless vector control, the upper and lower limits are for the commanded frequency. The final output frequency that is decided by each control may exceed the lower or upper limits.
- When **Pr.15 Jog frequency** is equal to or less than **Pr.2**, the **Pr.15** setting takes precedence.
- If a jump frequency that exceeds **Pr.1 (Pr.18)** is set for the 3-point frequency jump, the maximum frequency setting is the set frequency. If the jump frequency is less than the setting of **Pr.2**, the jump frequency is the set frequency. (The set frequency can be equal to or lower than the frequency lower limit.) When stall prevention is activated to decrease the output frequency, the output frequency may drop to **Pr.2** or below.

### CAUTION

- Note that when **Pr.2** is set to any value equal to or higher than **Pr.13 Starting frequency**, simply turning ON the start signal runs the motor at the frequency set in **Pr.2** even if the command frequency is not given.

### Parameters referred to

**Pr.13 Starting frequency** [page 381](#), [page 382](#)

**Pr.15 Jog frequency** [page 410](#)

**Pr.125 Terminal 2 frequency setting gain frequency, Pr.126 Terminal 4 frequency setting gain frequency** [page 505](#)

## 5.10.10 Avoiding machine resonance points (frequency jump)

When it is desired to avoid resonance attributable to the natural frequency of a mechanical system, these parameters allow resonant frequencies to be jumped.

Pr.	Name	Initial value	Setting range	Description
31 H420	Frequency jump 1A	9999	0 to 590 Hz, 9999	1A to 1B, 2A to 2B, 3A to 3B are frequency jumps (3-point jump). 9999: Function disabled
32 H421	Frequency jump 1B			
33 H422	Frequency jump 2A			
34 H423	Frequency jump 2B			
35 H424	Frequency jump 3A			
36 H425	Frequency jump 3B			
552 H429	Frequency jump range	9999	0 to 30 Hz 9999	Set the jump range for the frequency jumps (6-point jump). 3-point jump

### ◆ 3-point frequency jump (Pr.31 to Pr.36)

- Up to three areas may be set, with the jump frequencies set to either the top or bottom point of each area.
- The settings of frequency jumps 1A, 2A, 3A are jump points, and operation is performed at these frequencies in the jump areas.

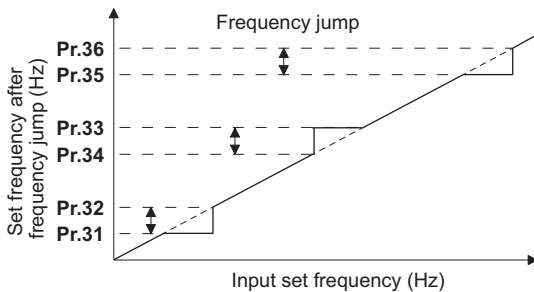

Example 1) To fix the frequency to 30 Hz in the range of 30 Hz to 35 Hz, set 35 Hz in **Pr.34** and 30 Hz in **Pr.33**.

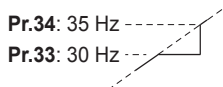

Example 2) To jump the frequency to 35 Hz in the range of 30 Hz to 35 Hz, set 35 Hz in **Pr.33** and 30 Hz in **Pr.34**.

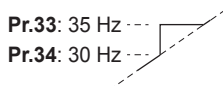

### ◆ 6-point frequency jump (Pr.552)

- A total of six jump areas can be set by setting the common jump range for the frequencies set in **Pr.31 to Pr.36**.
- When frequency jump ranges overlap, the lower limit of the lower jump range and the upper limit of the upper jump range are used.

- When the set frequency decreases and falls within the jump range, the upper limit of the jump range is the set frequency. When the set frequency increases and falls within the jump range, the lower limit of the jump range is the set frequency.

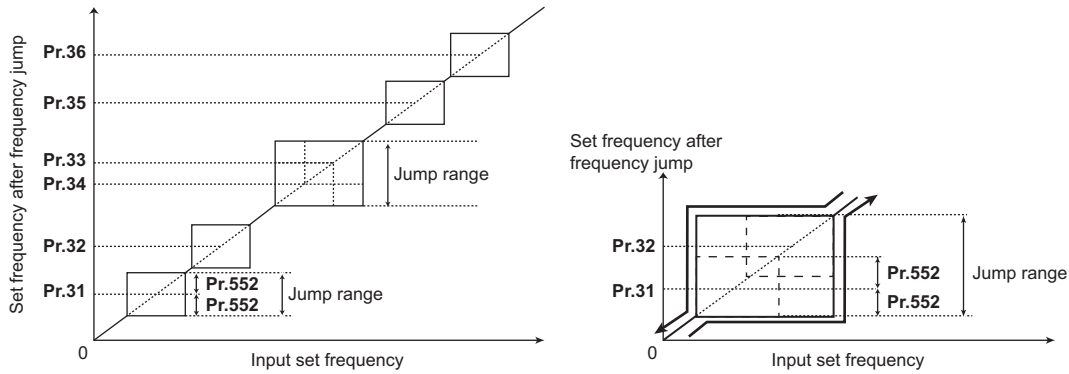

**NOTE**

- During acceleration/deceleration, the frequency within the set area is valid.
- If the setting ranges of individual groups (1A and 1B, 2A and 2B, 3A and 3B) overlap, Parameter write error (Er1) occurs.
- Setting **Pr.552** = "0" disables frequency jumps.
- If a jump frequency that exceeds **Pr.1 (Pr.18) Maximum frequency** is set for the 3-point frequency jump, the maximum frequency setting is the set frequency. If the jump frequency is less than the setting of **Pr.2 Minimum frequency**, the jump frequency is the set frequency. (The set frequency can be equal to or lower than the frequency lower limit.)  
Example with 6-point frequency jump

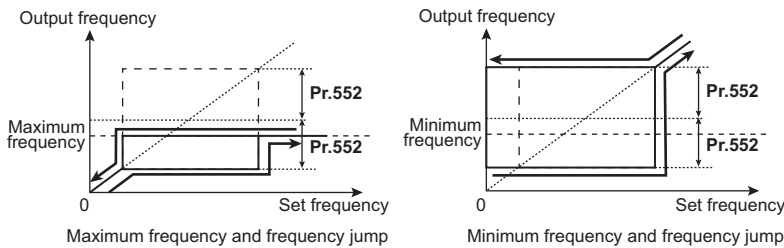

Parameters referred to

Pr.1 Maximum frequency, Pr.2 Minimum frequency, Pr.18 High speed maximum frequency [page 428](#)

## 5.10.11 Stall prevention operation



This function monitors the output current and automatically changes the output frequency to prevent the inverter from shutting off due to overcurrent, overvoltage, etc. It can also limit the stall prevention and fast-response current limit operation during acceleration/deceleration and power/regenerative driving.

This function is disabled during Real sensorless vector control, Vector control and PM sensorless vector control.

- Stall prevention:  
If the output current exceeds the stall prevention operation level, the output frequency of the inverter is automatically changed to reduce the output current. Also, the second stall prevention function can limit the output frequency range in which the stall prevention function is enabled.
- Fast-response current limit:  
If the current exceeds the limit value, the output of the inverter is shut off to prevent an overcurrent.

Pr.	Name	Initial value		Setting range	Description	
		FM	CA			
22 H500	Stall prevention operation level	150%		0	Stall prevention operation disabled.	
				0.1 to 400%*1	Set the current limit at which the stall prevention operation starts.	
156 H501	Stall prevention operation selection	0		0 to 31, 100, 101	Enable/disable the stall prevention operation and the fast-response current limit operation.	
48 H600	Second stall prevention operation level	150%		0	Second stall prevention operation disabled.	
				0.1 to 400%*1	The stall prevention operation level can be changed using the RT signal.	
49 H601	Second stall prevention operation frequency	0 Hz		0	Second stall prevention operation disabled.	
				0.01 to 590 Hz	Set the frequency at which the Pr.48 stall prevention operation starts.	
				9999	Pr.48 is enabled when the RT signal is ON.	
114 H602	Third stall prevention operation level	150%		0	Third stall prevention operation disabled.	
				0.1 to 400%*1	The stall prevention operation level can be changed using the X9 signal.	
115 H603	Third stall prevention operation frequency	0 Hz		0	Third stall prevention operation disabled.	
				0.01 to 590 Hz	Set the frequency at which the stall prevention operation starts when the X9 signal turns ON.	
23 H610	Stall prevention operation level compensation factor at double speed	9999		0 to 200%	The stall operation level when running at high speeds above the rated frequency can be reduced.	
				9999	Stall prevention operation disabled at double speed.	
66 H611	Stall prevention operation reduction starting frequency	60 Hz	50 Hz	0 to 590 Hz	Set the frequency at which the stall operation level reduction starts.	
148 H620	Stall prevention level at 0 V input	150%		0 to 400%*1	The stall prevention operation level can be changed by the analog signal input to the terminal 1 (terminal 4).	
149 H621	Stall prevention level at 10 V input	200%		0 to 400%*1		
154 H631	Voltage reduction selection during stall prevention operation	1		0	Output voltage reduction enabled	Enable/disable the output voltage reduction during stall prevention operation.
				1	Output voltage reduction disabled.	
				10	Output voltage reduction enabled	Use this setting when the overvoltage protective function (E.OV[]) is activated during stall prevention operation in an application with large load inertia.
				11	Output voltage reduction disabled.	
157 M430	OL signal output timer	0 s		0 to 25 s	Set the OL signal output start time when stall prevention is activated.	
				9999	No OL signal output.	
858 T040	Terminal 4 function assignment	0		0, 1, 4, 9999	When set "4", the stall prevention level can be changed with the signal to the terminal 4.	
868 T010	Terminal 1 function assignment	0		0 to 6, 9999	When set "4", the stall prevention level can be changed with the signal to the terminal 1.	

\*1 The upper limit of stall prevention operation is limited internally to the following.  
120% (SLD rating), 150% (LD rating), 220% (ND rating), or 280% (HD rating)

## ◆ Setting of stall prevention operation level (Pr.22)

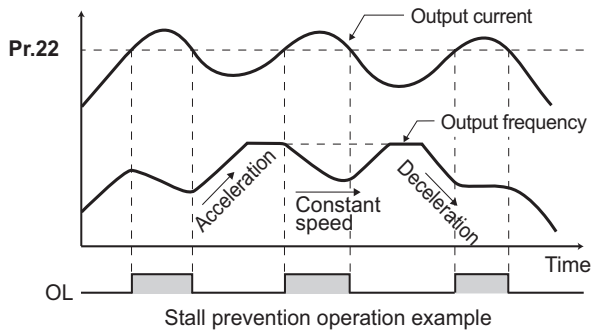

- For **Pr.22 Stall prevention operation level**, set the ratio of the output current to the inverter's rated current at which the stall prevention operation is activated. Normally, use this parameter in the initial setting.
- Stall prevention operation stops acceleration (makes deceleration) during acceleration, makes deceleration during constant speed, and stops deceleration during deceleration.
- When the stall prevention operation is performed, the Overload warning (OL) signal is output.

### NOTE

- A continuous overloaded condition may activate a protective function such as motor overload trip (electronic thermal O/L relay function) (E.THM).
- When **Pr.156** has been set to activate the fast response current limit (initial value), the **Pr.22** setting should not be higher than 170%. Such setting prevents torque generation.
- When Real sensorless vector control or Vector control is selected using **Pr.800 Control method selection**, **Pr.22** serves as the torque limit level.  
For the FR-A820-00250(3.7K) or lower and the FR-A840-00126(3.7K) or lower, the initial value of **Pr.22** is 200% instead of 150%.

## ◆ Disabling the stall prevention operation and fast-response current limit according to operating conditions (Pr.156)

- Referring to the following table, enable/disable the stall prevention operation and the fast-response current limit operation, and also set the operation at OL signal output.

Pr.156 setting	Fast-response current limit ○: enabled ●: disabled	Stall prevention operation selection ○: enabled ●: disabled			OL signal output ○: enabled ●: disabled <sup>*1</sup>
		Acceleration	Constant speed	Deceleration	
0 (initial value)	○	○	○	○	○
1	●	○	○	○	○
2	○	●	○	○	○
3	●	●	○	○	○
4	○	○	●	○	○
5	●	○	●	○	○
6	○	●	●	○	○
7	●	●	●	○	○
8	○	○	○	●	○
9	●	○	○	●	○
10	○	●	○	●	○
11	●	●	○	●	○
12	○	○	●	●	○
13	●	○	●	●	○
14	○	●	●	●	○
15	●	●	●	●	— <sup>*2</sup>
16	○	○	○	○	●
17	●	○	○	○	●
18	○	●	○	○	●
19	●	●	○	○	●
20	○	○	●	○	●
21	●	○	●	○	●
22	○	●	●	○	●
23	●	●	●	○	●
24	○	○	○	●	●
25	●	○	○	●	●
26	○	●	○	●	●
27	●	●	○	●	●
28	○	○	●	●	●
29	●	○	●	●	●
30	○	●	●	●	●
31	●	●	●	●	— <sup>*2</sup>
100 <sup>*3</sup>	Power driving	○	○	○	○
	Regenerative driving	●	●	●	— <sup>*2</sup>
101 <sup>*3</sup>	Power driving	●	○	○	○
	Regenerative driving	●	●	●	— <sup>*2</sup>

\*1 When "operation stop at OL signal output" is selected, the fault output "E. OLT" (stop due to stall prevention) is displayed, and operation stops.

\*2 The OL signal and E.OLT are not outputted because fast-response current limit and stall prevention are not operating.

\*3 Setting values "100, 101" can be individually set for power driving and regenerative driving. The setting value "101" disables the fast-response current limit during power driving.

### NOTE

- When the load is heavy or the acceleration/deceleration time is short, stall prevention operates and acceleration/deceleration may not be performed according to the time set. Set **Pr.156** and stall prevention operation level to the optimum values.
- For lift applications, make settings to disable the fast-response current limit. Otherwise, the torque may be insufficient, causing the load to drop.

## ◆ Adjusting the stall prevention operation signal and output timing (OL signal, Pr.157)

- If the output current exceeds the stall prevention operation level and stall prevention is activated, Overload warning (OL) signal turns ON for 100 ms or more. The output signal turns OFF when the output current falls to the stall prevention operation level or less.
- **Pr.157 OL signal output timer** can be used to set whether to output the OL signal immediately, or whether to output it after a certain time period has elapsed.
- This function also operates during regeneration avoidance operation "OL" (overvoltage stall).

Pr.157 setting	Description
0 (initial value)	Output immediately.
0.1 to 25	Output after the set time (s).
9999	Not output.

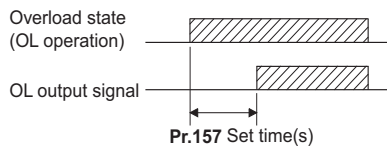

### NOTE

- OL signal is assigned to the terminal OL in the initial status. The OL signal can be assigned to other terminals by setting "3 (positive logic) or 103 (negative logic)" in any of **Pr.190 to Pr.196 (Output terminal function selection)**.
- If the stall prevention operation has lowered the output frequency to 0.5 Hz and kept the level for 3 seconds, the stall prevention stop (E.OLT) is activated to shut off the inverter output.
- Changing the terminal assignment using **Pr.190 to Pr.196 (Output terminal function selection)** may affect the other functions. Set parameters after confirming the function of each terminal.

## ◆ Setting for stall prevention operation in the high-frequency range (Pr.22, Pr.23, Pr.66)

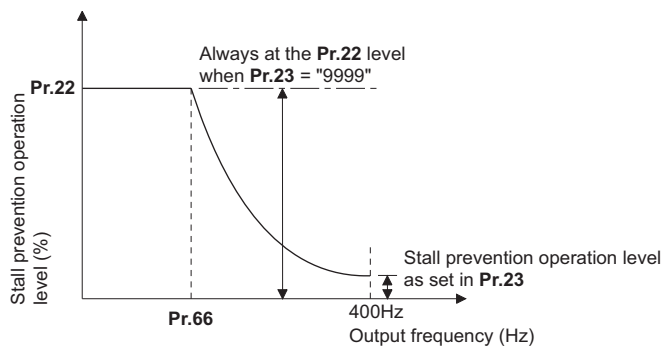

Setting example (Pr.22 = 120%, Pr.23 = 100%, Pr.66 = 60Hz)

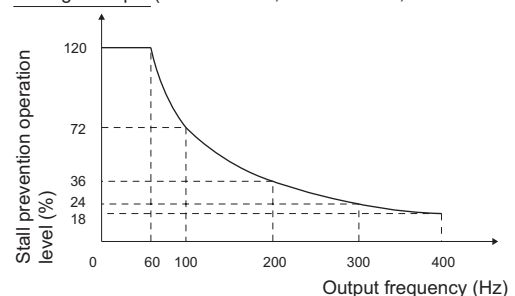

- When operating at the rated motor frequency or higher, acceleration may not be made because the motor current does not increase. Also, when operating in the high-frequency range, the current flowing to the locked motor becomes less than the rated output current of the inverter; and even if the motor is stopped, the protective function does not operate (OL). In a case like this, the stall prevention level can be reduced in the high-frequency range to improve the motor's operating characteristics. This is useful when operating up to the high speed range, such as when using a centrifuge. Normally, set **Pr.66 Stall prevention operation reduction starting frequency** to 60 Hz, and **Pr.23 Stall prevention operation level compensation factor at double speed** to 100%.
- Calculation formula for stall prevention operation level  
 Stall prevention operation level (%) in the high-frequency range =  $A + B \times \left[ \frac{\text{Pr.22} - A}{\text{Pr.22} - B} \right] \times \left[ \frac{\text{Pr.23} - 100}{100} \right]$   
 Where,  $A = \frac{\text{Pr.66 (Hz)} \times \text{Pr.22} (\%)}{\text{Output frequency (Hz)}}$ ,  $B = \frac{\text{Pr.66 (Hz)} \times \text{Pr.22} (\%)}{400 \text{ Hz}}$
- When **Pr.23 = "9999"** (initial value), the stall prevention operation level is constant at the **Pr.22** level up to 590 Hz.



## ◆ Setting multiple stall prevention operation levels (Pr.48, Pr.49, Pr.114, Pr.115)

- Setting **Pr.49 Second stall prevention operation frequency** = "9999" and turning ON the RT signal enables **Pr.48 Second stall prevention operation level**.
- For **Pr.48 (Pr.114)**, set the stall prevention operation level that is effective in the output frequency range between 0 Hz and **Pr.49 (Pr.115)**. However, the operation level is **Pr.22** during acceleration.
- Stop-on-contact operation can be used by decreasing the **Pr.48 (Pr.114)** setting and loosening the reduction torque.
- **Pr.114 and Pr.115** are enabled when the X9 signal is ON. To input the X9 signal, set "9" in any of **Pr.178 to Pr.189 Input terminal function selection** to assign the function to the terminal.

Pr.49 setting	Pr.115 setting	Operation
0 (initial value)		The second (third) stall prevention function disabled.
0.01 Hz to 590 Hz		The second (third) stall prevention function operates according to the frequency.*1
9999*2	Setting not available	The second stall prevention function operates according to the RT signal. RT signal ON: stall level set in <b>Pr.48</b> , RT signal OFF: stall level set in <b>Pr.22</b>

\*1 For the stall prevention operation level, the smaller of **Pr.22** and **Pr.48 (Pr.115)** has precedence.

\*2 **When Pr.858 = "4** (analog input to terminal 4 for stall prevention operation level)" or **Pr.868 = "4** (analog input to terminal 1 for stall prevention operation level)", turning ON the RT (X9) signal does not enable the second (third) stall prevention function. (Input to the terminal 4 or terminal 1 is valid.)

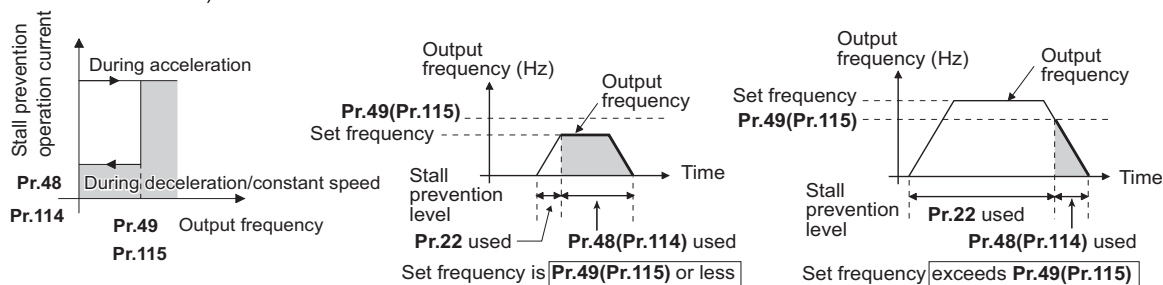

### NOTE

- When **Pr.49** ≠ "9999" (level change according to frequency) and **Pr.48** = "0%", the stall prevention function is disabled at or lower than the frequency set in **Pr.49**.
- The RT signal is assigned to the terminal RT in the initial status. Set "3" in one of **Pr.178 to Pr.189 (Input terminal function selection)** to assign the RT signal to another terminal.
- Changing the terminal assignment using **Pr.178 to Pr.189 (Input terminal function selection)** may affect the other functions. Set parameters after confirming the function of each terminal.
- The RT (X9) signal acts as the second (third) function selection signal and makes the other second (third) functions valid. (Refer to [page 525](#).)

## ◆ Stall prevention operation level setting (analog variable) from terminal 1 (terminal 4) (Pr.148, Pr.149, Pr.858, Pr.868)

- To use the terminal 1 (analog voltage input) to set the stall prevention operation level, set **Pr.868 Terminal 1 function assignment** = "4". Then, input a 0 to 5 V (or 0 to 10 V) to the terminal 1. To choose whether 5 V or 10 V, use **Pr.73 Analog input selection**. In the initial status, **Pr.73** = "1 (initial value)" is set to choose 0 to ±10 V input.
- When setting the stall prevention operation level from terminal 4 (analog current input), set **Pr.858 Terminal 4 function assignment** = "4". Input a 0 to 20 mA to the terminal 4. There is no need to turn ON the AU signal.
- Set **Pr.148 Stall prevention level at 0 V input** to the current limit level when input voltage is 0 V (0 mA).

- Set **Pr.149 Stall prevention level at 0 V input** to the current limit level when input voltage is 10 V/5 V (20 mA).

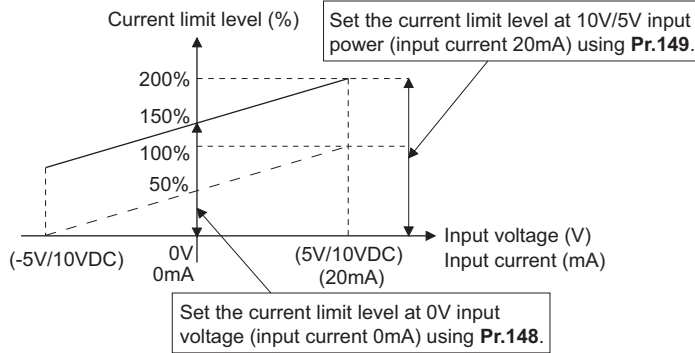

Pr.858 setting	Pr.868 setting	V/F, Advanced magnetic flux vector control	
		Terminal 4 function	Terminal 1 function
0 (initial value)	0 (initial value)	Frequency command (AU signal-ON)	Auxiliary frequency
	1		—
	2		—
	3		—
	4*1		Stall prevention
	5		—
	6		—
	9999		—
1	0 (initial value)	—	—
	1		—
	2		—
	3		—
	4*1		Stall prevention
	5		—
	6		—
	9999		—
4*2	0 (initial value)	Stall prevention	Auxiliary frequency
	1		—
	2		—
	3		—
	4*1		—*3
	5		—
	6		Stall prevention
	9999		—
9999	—	—	—

\*1 When **Pr.868** = "4" (analog stall prevention), the other functions of terminal 1 (auxiliary input, override function, PID control) do not operate.  
 \*2 When **Pr.858** = "4" (analog stall prevention), PID control and speed commands via terminal 4 do not operate even when the AU signal is ON.  
 \*3 When both **Pr.858** and **Pr.868** are set to "4" (stall prevention), terminal 1 functions take priority and terminal 4 has no function.

**NOTE**

- The fast-response current limit cannot be set.

◆ **Further prevention of a trip (Pr.154)**

- **Pr.154 Voltage reduction selection during stall prevention operation** = "0, 10", the output voltage is reduced during stall prevention operation. By making this setting, an overcurrent trip becomes less likely to occur. Use this setting when torque reduction does not pose a problem. (Under V/F control, the output voltage is reduced only during the stall prevention operation is activated.)

- Set **Pr.154** = "10 or 11" when the overvoltage protective function (E.OV[]) is activated during stall prevention operation in an application with large load inertia. Note that turning OFF the start signal (STF/STR) or varying the frequency command during stall prevention operation may delay the acceleration/deceleration start.

Pr.154	E.OC[] countermeasure	E.OV[] countermeasure
0	Enabled	—
1 (initial value)	—	—
10	Enabled	Enabled
11	—	Enabled

## CAUTION

- Do not set the stall prevention operation current too low.  
Doing so will reduce the generated torque.
- Be sure to perform the test operation.  
Stall prevention operation during acceleration may extend the acceleration time.  
Stall prevention operation during constant-speed operation may cause sudden speed changes.  
Stall prevention operation during deceleration may extend the deceleration time.

### «Parameters referred to»

Pr.22 Torque limit level  [page 245](#)

Pr.73 Analog input selection  [page 496](#)

Pr.178 to Pr.189 (Input terminal function selection)  [page 521](#)

Pr.190 to Pr.196 (Output terminal function selection)  [page 473](#)

Pr.858 Terminal 4 function assignment, Pr.868 Terminal 1 function assignment  [page 500](#)

## 5.10.12 Load characteristics fault detection

This function is used to monitor whether the load is operating in normal condition by storing the speed/torque relationship in the inverter to detect mechanical faults or for maintenance. When the load operating condition deviates from the normal range, the protective function is activated or the warning is output to protect the inverter or the motor.

Pr.	Name	Initial value		Setting range	Description
		FM	CA		
1480 H520	Load characteristics measurement mode	0		0	Load characteristics measurement mode does not start. (Measurement of load characteristics complete without fault.)
				1	Load characteristics measurement mode starts.
				2, 3, 4, 5, 81, 82, 83, 84, 85	The load characteristics measurement status is displayed. (Read-only)
1481 H521	Load characteristics load reference 1	9999		0 to 400%	Set the reference value of normal load characteristics. 8888: The present load status is written as reference status. 9999: The load reference is invalid.
1482 H522	Load characteristics load reference 2	9999			
1483 H523	Load characteristics load reference 3	9999			
1484 H524	Load characteristics load reference 4	9999			
1485 H525	Load characteristics load reference 5	9999			
1486 H526	Load characteristics maximum frequency	60 Hz	50 Hz	0 to 590 Hz	Set the maximum frequency of the load characteristics fault detection range.
1487 H527	Load characteristics minimum frequency	6 Hz		0 to 590 Hz	Set the minimum frequency of the load characteristics fault detection range.
1488 H531	Upper limit warning detection width	20%		0 to 400%	Set the detection width when the upper limit load fault warning is output.
				9999	Function disabled
1489 H532	Lower limit warning detection width	20%		0 to 400%	Set the detection width when the lower limit load fault warning is output.
				9999	Function disabled
1490 H533	Upper limit fault detection width	9999		0 to 400%	Set the detection width when output is shut off when the upper limit load fault occurs.
				9999	Function disabled
1491 H534	Lower limit fault detection width	9999		0 to 400%	Set the detection width when output is shut off when the lower limit load fault occurs.
				9999	Function disabled
1492 H535	Load status detection signal delay time / load reference measurement waiting time	1 s		0 to 60 s	Set the waiting time after the load fault is detected until warning output or output shutoff. In the load characteristics measurement mode, set the waiting time after the load measurement frequency is reached until the load reference is set.

### ◆ Load characteristics reference setting (Pr.1481 to Pr.1487)

- Use Pr.1481 to Pr.1485 to set the reference value of load characteristics.

- Use **Pr.1486 Load characteristics maximum frequency** and **Pr.1487 Load characteristics minimum frequency** to set the output frequency range for load fault detection.

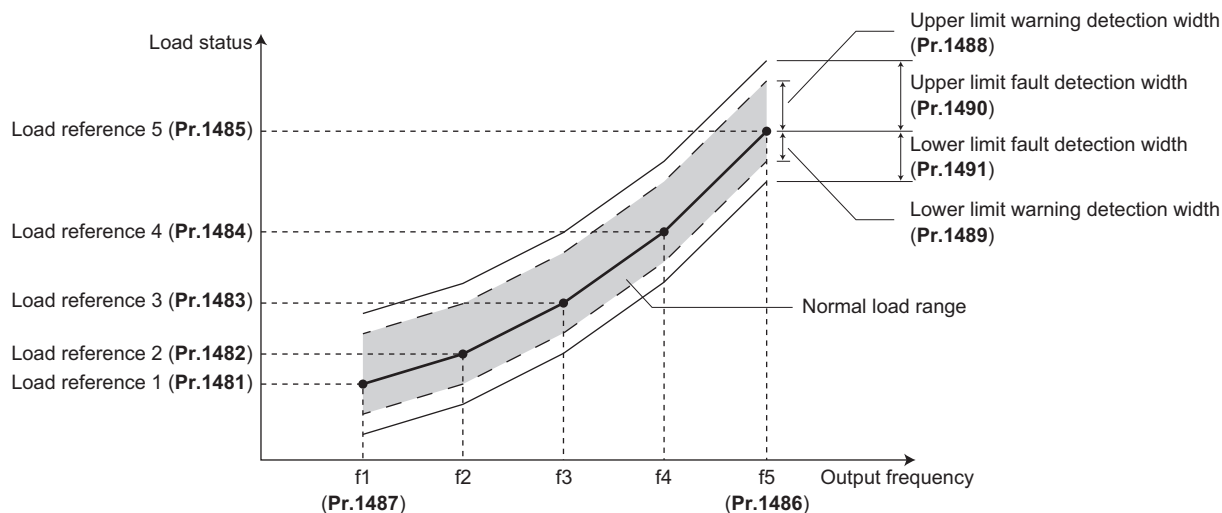

## ◆ Automatic measurement of the load characteristics reference (Load characteristics measurement mode) (Pr.1480)

### Point

- Perform measurement under actual environment with the motor connected.
- Set **Pr.1487 Load characteristics minimum frequency** to a value higher than the **Pr.13 Starting frequency** setting.

- Setting **Pr.1480 Load characteristics measurement mode** = "1" enables automatic measurement of the load characteristics reference. (Load characteristics measurement mode)
- Use **Pr.1486** and **Pr.1487** to set the frequency band for the measurement, and set **Pr.1480** = "1". After setting, when the inverter is started, the measurement starts. (When the value set in **Pr.1486** is smaller than the value set in **Pr.1487**, the measurement does not start.)
- The automatically measured load characteristics reference is written in **Pr.1481 to Pr.1485**.
- After the measurement is started, read **Pr.1480** to display the status of the measurement. If "8" appears in the tens place, the measurement has not properly completed.

Read value of Pr.1480		Status
Tens place	Ones place	
—	1	During measurement from the starting point to Point 1
—	2	During measurement from Point 1 to Point 2
—	3	During measurement from Point 2 to Point 3
—	4	During measurement from Point 3 to Point 4
—	5	During measurement from Point 4 to Point 5
—	0	Normal completion
8	1 to 5	Termination of measurement by an activation of a protective function, Inverter reset, turning ON of MRS signal, turning OFF of the start command, or timeout. (The value in the ones place represents the above-mentioned measurement point.)

- While measuring automatically, the During load characteristics measurement (Y213) signal is output. For the Y213 signal, assign the function by setting "213 (positive logic)" or "313 (negative logic)" in any of in any of **Pr.190 to Pr.196 (Output terminal function selection)**.

- Setting "8888" in **Pr.1481 to Pr.1485** enables fine adjustment of load characteristics. When setting **Pr.1481 to Pr.1485** = "8888" during operation, the load status at that point is set in the parameter. (Only when the set frequency is within  $\pm 2$  Hz of the frequency of the measurement point, and SU signal is in the ON state.)

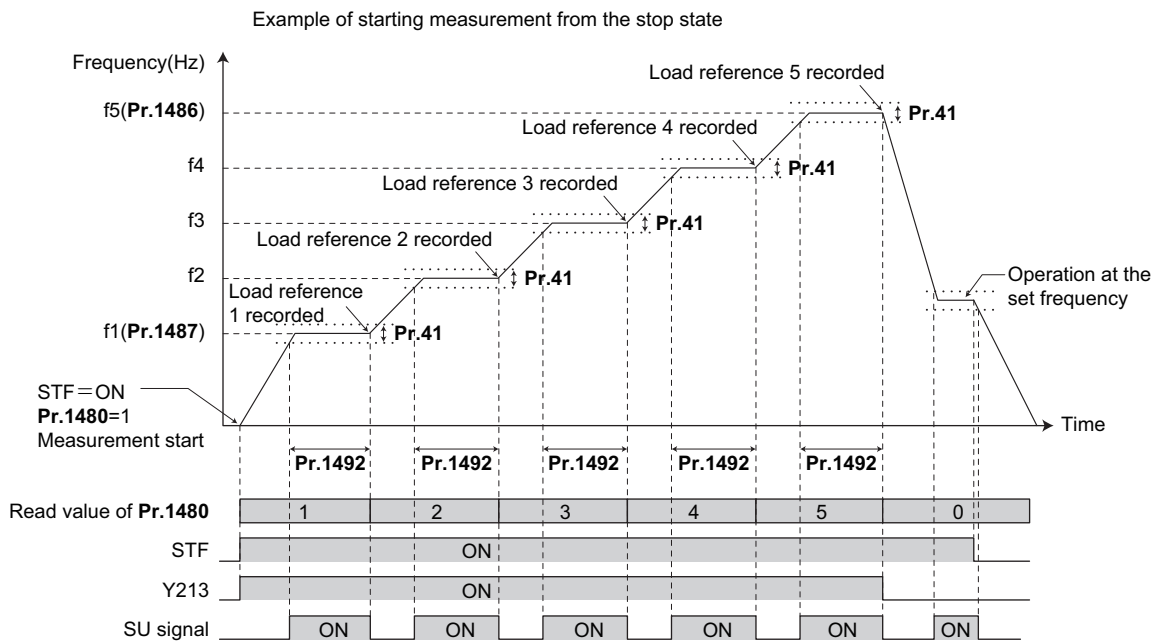

**NOTE**

- Even if the load measurement is not properly completed, the load characteristics fault is detected based on the load characteristics found by the already-completed portion of the measurement.
- During the load characteristics measurement, the load characteristics fault detection is not performed.
- During the load characteristics measurement, linear acceleration/deceleration is performed even if the S-pattern acceleration/deceleration is set.
- Changing the terminal assignment using **Pr.190 to Pr.196 (Output terminal function selection)** may affect the other functions. Set parameters after confirming the function of each terminal.

**◆ Setting the load characteristics reference manually (Pr.1481 to Pr.1485)**

- Set **Pr.1480 Load characteristics measurement mode** = "0" (initial value).
- Set **Pr.1486 and Pr.1487** to specify the frequency band for the measurement, and calculate the frequency as the load characteristics reference ( $f_2$  to  $f_4$ ) using the following table.
- Start the inverter operation, and set **Pr.1481** = "8888" during operation at the frequency of the load characteristics reference 1 ( $f_1$ ). The load status at that point is set in **Pr.1481** (only when the set frequency is within  $\pm 2$  Hz of the frequency of the measurement point, and the SU signal is ON).
- Set load references in **Pr.1482 to Pr.1485** in the same way as **Pr.1481**.

Reference	Frequency	Load reference
Load characteristics reference 1	$f_1$ : load characteristics minimum frequency ( <b>Pr.1487</b> )	<b>Pr.1481</b>
Load characteristics reference 2	$f_2 = (f_5 - f_1)/4 + f_1$	<b>Pr.1482</b>
Load characteristics reference 3	$f_3 = (f_5 - f_1)/2 + f_1$	<b>Pr.1483</b>
Load characteristics reference 4	$f_4 = (f_5 - f_1) \times 3/4 + f_1$	<b>Pr.1484</b>
Load characteristics reference 5	$f_5$ : load characteristics maximum frequency ( <b>Pr.1486</b> )	<b>Pr.1485</b>

**NOTE**

- When inputting values directly in **Pr.1481 to Pr.1485** under V/F control or Advanced magnetic flux vector control, input the load meter value monitored at each reference frequency.
- When inputting values directly in **Pr.1481 to Pr.1485** under Real sensorless vector control, Vector control, or PM sensorless vector control, input the motor torque value monitored at each reference frequency.

## ◆ Load fault detection setting (Pr.1488 to Pr.1491)

- When the load is deviated from the detection width set in **Pr.1488 Upper limit warning detection width**, the Upper limit warning detection (LUP) signal is output. When the load is deviated from the detection width set in **Pr.1489 Lower limit warning detection width**, the Lower limit warning detection (LDN) signal is output. At the same time, the Load fault warning (LDF) appears on the operation panel.
- For the LUP signal, assign the function by setting "211 (positive logic)" or "311 (negative logic)" in any of **Pr.190 to Pr.196 (Output terminal function selection)**. For the LDN signal, assign the function by setting "212 (positive logic)" or "312 (negative logic)" in any of **Pr.190 to Pr.196 (Output terminal function selection)**.
- When the load is deviated from the detection width set in **Pr.1490 Upper limit fault detection width**, the protective function (E.LUP) is activated and the inverter output is shut off. When the load is deviated from the detection width set in **Pr.1491 Lower limit fault detection width**, the protective function (E.LDN) is activated and the inverter output is shut off.
- To prevent the repetitive on/off operation of the signal due to load fluctuation near the detection range, **Pr.1492 Load status detection signal delay time / load reference measurement waiting time** can be used to set the delay time. Even when a fault is detected out of the detection range once, the warning is not output if the characteristics value returns to the normal range from a fault state within the output delay time.

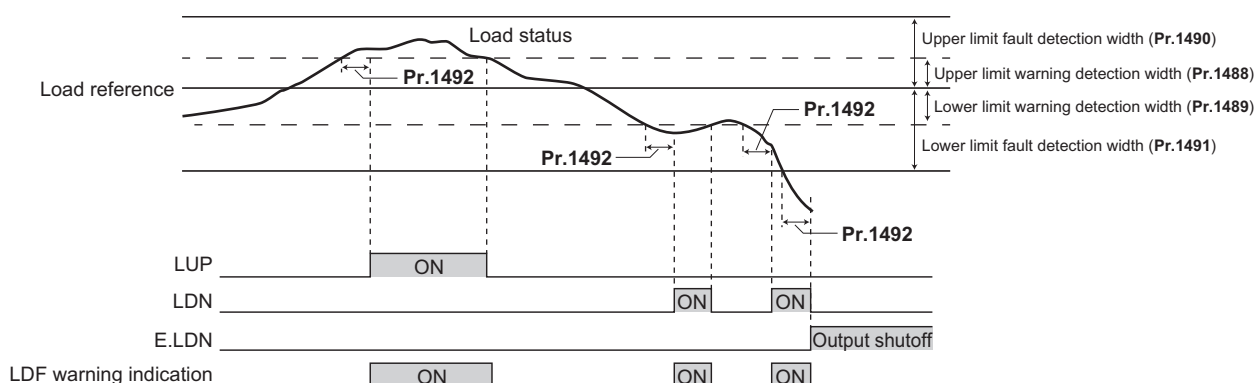

### NOTE

- Changing the terminal assignment using **Pr.190 to Pr.196 (Output terminal function selection)** may affect the other functions. Set parameters after confirming the function of each terminal.

## ◆ Setting example

- The load characteristics are calculated from the parameter setting and the output frequency.
- A setting example is as follows. The reference value is linearly interpolated from the parameter settings. For example, the reference when the output frequency is 30 Hz is 26%, which is linearly interpolated from values of the reference 2 and the reference 3.

Reference	Frequency	Load reference
Load characteristics reference 1	f1: Load characteristics minimum frequency ( <b>Pr.1487</b> ) = 10 Hz	<b>Pr.1481</b> = 15%
Load characteristics reference 2	f2 = (f5 - f1)/4 + f1 = 22.5 Hz	<b>Pr.1482</b> = 20%
Load characteristics reference 3	f3 = (f5 - f1)/2 + f1 = 35 Hz	<b>Pr.1483</b> = 30%
Load characteristics reference 4	f4 = (f5 - f1) × 3/4 + f1 = 47.5 Hz	<b>Pr.1484</b> = 60%
Load characteristics reference 5	f5: Load characteristics maximum frequency ( <b>Pr.1486</b> ) = 60 Hz	<b>Pr.1485</b> = 100%

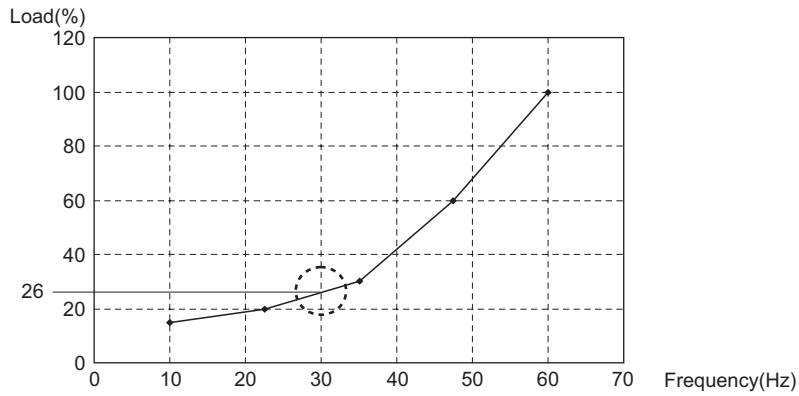

**NOTE**

- When the load reference is not set for five points, the load characteristics value is determined by linear interpolation of the set load reference values only. If there is only one load reference setting, the set load reference is used as the load reference all through the range.

Parameters referred to

Pr.41 Up-to-frequency sensitivity [page 484](#)

Pr.190 to Pr.196 (Output terminal function selection) [page 473](#)

### 5.10.13 Motor overspeeding detection

The Overspeed occurrence (E.OS) is activated when the motor speed exceeds the overspeed detection level. This function prevents the motor from accidentally speeding over the specified value, due to an error in parameter setting, etc.

Pr.	Name	Initial value	Setting range	Description
374 H800	Overspeed detection level	9999	0 to 590 Hz	If the motor rotation speed exceeds the speed set in <b>Pr.374</b> during encoder feedback control, Real sensorless vector control, Vector control or PM sensorless vector control, Overspeed occurrence (E.OS) occurs, the inverter output is shut off.
			9999	If the speed exceeds "the maximum speed ( <b>Pr.1</b> , <b>Pr.18</b> ) + 20 Hz" during encoder feedback control, Real sensorless vector control, or Vector control, E.OS occurs. During PM sensorless vector control, E.OS occurs when the speed exceeds the "maximum motor frequency + 10 Hz" <sup>*1</sup> .

\*1 The motor maximum frequency is set in **Pr.702 Maximum motor frequency**. When **Pr.702** = "9999 (initial value)", the **Pr.84 Rated motor frequency** is used as the maximum motor frequency.

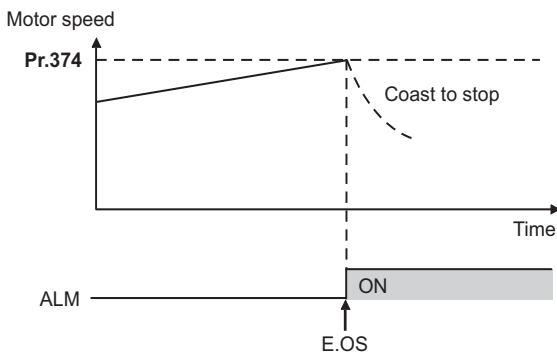

**NOTE**

- During the encoder feedback control operation or under Vector control, the motor speed is compared against **Pr.374**. Under Real sensorless vector control or PM sensorless vector control, the output frequency is compared against **Pr.374**.



## 5.11 (M) Item and output signal for monitoring

Purpose	Parameter to set			Refer to page
To display the motor speed (the number of rotations per minute). To switch the unit of measure to set the operation speed from frequency to motor speed.	Speed indication and its setting change to rotations per minute	P.M000 to P.M002, P.D030	Pr.37, Pr.144, Pr.505, Pr.811	444
To change the item monitored on the operation panel and parameter unit	Operation panel monitor item selection, clearing the cumulative value during monitoring	P.M020 to P.M023, P.M030, P.M031, P.M044, P.M045, P.M050 to P.M052, P.M100 to P.M104	Pr.52, Pr.170, Pr.171, Pr.268, Pr.290, Pr.563, Pr.564, Pr.774 to Pr.776, Pr.891, Pr.992, Pr.1018, Pr.1106 to Pr.1108	446
To change the monitor item whose data is output via terminal FM (CA) or AM	Terminal FM (CA) function selection	P.M040 to P.M042, P.M044, P.M300, P.M301, P.D100	Pr.54, Pr.55, Pr.56, Pr.158, Pr.290, Pr.291, Pr.866	457
To adjust the output via terminal FM (CA) or AM	Terminal FM (CA)/AM calibration	P.M310, P.M320, P.M321, P.M330 to P.M334	Pr.867, Pr.869, C0 (Pr.900), C1 (Pr.901), C8 (Pr.930) to C11 (Pr.931)	463
To check the effects of energy saving	Energy saving monitoring	P.M023, P.M100, P.M200 to P.M207, P.M300, P.M301	Pr.52, Pr.54, Pr.158, Pr.891 to Pr.899	467
To assign functions to the output terminals	Output terminal function assignment	P.M400 to P.M406, P.M410 to P.M416, P.M420 to P.M422, P.M431	Pr.190 to Pr.196, Pr.289, Pr.313 to Pr.322	473
To detect the output frequency	Up-to-frequency sensitivity Output frequency detection Low speed detection	P.M440 to P.M446	Pr.41 to Pr.43, Pr.50, Pr.116, Pr.865, Pr.870	484
To detect the output current	Output current detection Zero current detection	P.M433, P.M460 to P.M464	Pr.150 to Pr.153, Pr.166, Pr.167	487
To detect the output torque	Output torque detection	P.M470	Pr.864	488
To use the remote output function	Remote output	P.M500 to P.M502	Pr.495 to Pr.497	489
To use the analog remote output function	Analog remote output	P.M530 to P.M534	Pr.655 to Pr.659	490
To output the fault code via a terminal	Fault code output function	P.M510	Pr.76	492
To detect the specified output power	Pulse train output of output power	P.M520	Pr.799	493
To detect the control circuit temperature	Control circuit temperature monitoring	P.M060	Pr.663	494
To monitor pulses	Cumulative pulse monitoring	P.M610 to P.M613	Pr.635 to Pr.638	321
To output divided encoder pulses	Encoder pulse dividing output	P.M600, P.M601	Pr.413, Pr.863	495

### 5.11.1 Speed indication and its setting change to rotations per minute

The frequency monitored or set on the operation panel can be changed to the motor speed or the machine speed.

Pr.	Name	Initial value		Setting range	Description	
		FM	CA			
37 M000	Speed display	0		0	Monitoring and setting of frequency	
				1 to 9998*1	Set a number for the speed of machine operated at the speed (frequency) set in <b>Pr.505</b> .	
505 M001	Speed setting reference	60 Hz	50 Hz	1 to 590 Hz	Set the reference speed (frequency) for <b>Pr.37</b> .	
144 M002	Speed setting switchover	4		0, 2, 4, 6, 8, 10, 12, 102, 104, 106, 108, 110, 112	Set the number of motor poles for the indication of the motor speed.	
811 D030	Set resolution switchover	0		0	Speed setting, running speed monitor increments 1 r/min	
				1	Speed setting, running speed monitor increments 0.1 r/min	Torque limit setting increments 0.1%
				10	Speed setting, running speed monitor increments 1 r/min	Torque limit setting increments 0.01%
				11	Speed setting, running speed monitor increments 0.1 r/min	

\*1 The maximum value of the setting range differs according to the **Pr.1 Maximum frequency**, **Pr.505 Speed setting reference**, and it can be calculated from the following formula.

The maximum value of **Pr.37** <  $65535 \times \text{Pr.505} / \text{Pr.1}$  setting value (Hz).

The maximum setting value of **Pr.37** is 9998 if the result of the above formula exceeds 9998.

### ◆ Indication of motor speed (Pr.37, Pr.144)

- To change the indication to the motor speed, set the number of motor poles (2, 4, 6, 8, 10, or 12) or the number of motor poles with the addition of 100 (102, 104, 106, 108, 110, or 112) in **Pr.144**.
- Whenever the number of motor poles set in **Pr.81 Number of motor poles** is changed, the **Pr.144** setting changes automatically in conjunction with **Pr.81**. However, the **Pr.81** setting does not automatically change when the **Pr.144** setting is changed.

Example 1) Changing the initial value of **Pr.81** to "2" will change the **Pr.144** setting from "4" to "2".

Example 2) Changing the **Pr.81** setting to "2" while **Pr.144** = "104" will change the **Pr.144** setting from "104" to "102".

### ◆ Indication of machine speed (Pr.37, Pr.505)

- To change the indication to the machine speed, set a number in **Pr.37** which corresponds to the speed of machine operated at the frequency set in **Pr.505**.
- For example, when **Pr.505** is set to 60 Hz and **Pr.37** is set to "1000", the operation panel indicates "1000" as the monitor value of machine speed while the output frequency is 60 Hz. "500" is displayed while the output frequency is 30 Hz.

### ◆ Changing the increment of the speed monitoring and setting (Pr.811)

- When **Pr.811** = "1 or 11", the speed can be set in increments of 0.1 r/min on the PU, or can be set and monitored in increments of 0.1 r/min via RS-485 communication or other communication with a corresponding communication option installed. (The parameter setting is in 1 r/min increments.)
- For the information of the availability of changing the increments of speed setting on communication options, refer to the Instruction Manual of each communication option.
- Refer to [page 245](#) for details on the setting increments for the torque limit level.

### ◆ Monitoring/setting items and its increments

- When both settings of **Pr.37** and **Pr.144** are changed from the initial values, a precedence order for these settings is as follows:

**Pr.144** = "102 to 112" > **Pr.37** = "1 to 9998" > **Pr.144** = "2 to 12".

- The monitoring/setting items and its increments are listed with the following matrix to show the combination of the **Pr.37** and **Pr.144** settings.

Pr.37 setting	Pr.144 setting	Output frequency indication	Set frequency indication	Running speed indication	Indication of frequency setting parameter
0 (initial value)	0	0.01 Hz	0.01 Hz	1 r/min <sup>*1*2</sup>	0.01 Hz.
	2 to 12	0.01 Hz (initial setting)	0.01 Hz (initial setting)	1 r/min <sup>*1*2</sup> (initial setting)	0.01 Hz (initial setting)
	102 to 112	1 r/min <sup>*1*2</sup>	1 r/min <sup>*1*2</sup>	1 r/min <sup>*1*2</sup>	1 r/min <sup>*1</sup>
1 to 9998	0	0.01 Hz	0.01 Hz	1 (machine speed <sup>*1</sup> )	0.01 Hz.
	2 to 12	1 (machine speed <sup>*1</sup> )	1 (machine speed <sup>*1</sup> )	1 (machine speed <sup>*1</sup> )	1 (machine speed <sup>*1</sup> )
	102 to 112	0.01 Hz	0.01 Hz	1 r/min <sup>*1*2</sup>	0.01 Hz.

\*1 Motor speed r/min conversion formula: frequency × 120 / number of motor poles (Pr.144)

Machine speed conversion formula: Pr.37 × frequency / Pr.505

The Pr.144 value in the above formula is "Pr.144 - 100" when any of "102 to 112" is set in Pr.144. The value is "4" when Pr.37 = 0 and Pr.144 = 0. The item set in Pr.505 is consistently a frequency (Hz).

\*2 The increment can be changed in Pr.811 from 1 r/min to 0.1 r/min.

## NOTE

- The inverter's output frequency is displayed as synchronous speed under V/F control. The displayed value is "actual motor speed" + "motor slip". When Advanced magnetic flux vector control, Real sensorless vector control, or PM sensorless vector control is selected, the actual motor speed (estimated value by motor slip calculation) is used. When the encoder feedback control or vector control is selected, the actual motor speed from the encoder is used.
- When Pr.37 = "0" and Pr.144 = "0", the running speed monitor is displayed with the number of motor poles 4. (Displays 1800 r/min at 60 Hz)
- To change the PU main monitor (PU main display), refer to Pr.52.
- If the setting increment is changed to 1 r/min (Pr.811 = "0 or 10") after setting the running speed in 0.1 r/min (Pr.811 = "1 or 11"), the 0.1 r/min increment may be dropped, in order for the rotations per minute resolution to change from 0.1 r/min to 0.3 r/min (when using four poles).
- When using the machine speed display for the parameter unit (FR-PU07), do not change the speed with the up/down key if a set speed above 65535 is displayed. The set speed may become an undetermined value.
- When a certain type of communication option is used, the frequency display (setting) is used regardless of the Pr.37 and Pr.144 settings. Refer to the Instruction Manual of each communication option for details. (The frequency display (setting) is always used for HMS network options.)
- When Pr.811 = "1 or 11" with the 0.1 r/min increment, the upper limit is as follows.  
Speed command setting range: 6000 r/min for 2 to 10 motor poles, 5900 r/min for 12 motor poles  
Running speed monitor such as the operation panel: 6553.5 r/min  
Full scale of the running speed motor for analog output (terminals FM, CA and AM): 6000 r/min

## CAUTION

- Make sure to set the running speed and the number of motor poles.  
Otherwise, the motor might run at extremely high speed, damaging the machine.

### Parameters referred to

Pr.1 Maximum frequency [page 428](#)

Pr.22 Torque limit level [page 245](#)

Pr.52 Operation panel main monitor selection [page 446](#)

Pr.81 Number of motor poles [page 221](#)

Pr.800 Control method selection [page 221](#)

Pr.811 Set resolution switchover [page 245](#)

## 5.11.2 Monitor item selection on operation panel or via communication

The monitor item to be displayed on the operation panel or the parameter unit can be selected.

Pr.	Name	Initial value	Setting range	Description
52 M100	Operation panel main monitor selection	0 (output frequency)	0, 5 to 14, 17 to 20, 22 to 36, 38 to 46, 50 to 57, 61, 62, 64, 67, 71 to 75, 87 to 98, 100	Select the item monitored on the operation panel or parameter unit. Refer to <a href="#">page 447</a> for the monitor item selection.

Pr.	Name	Initial value	Setting range	Description
774 M101	Operation panel monitor selection 1	9999	1 to 3, 5 to 14, 17 to 20, 22 to 36, 38 to 46, 50 to 57, 61, 62, 64, 67, 71 to 75, 87 to 98, 100, 9999	Each of the initial items monitored on the operation panel or parameter unit in the monitor mode (output frequency, output current, and output voltage) can be switched to a user-designated item. 9999: Follows the <b>Pr.52</b> setting.
775 M102	Operation panel monitor selection 2			
776 M103	Operation panel monitor selection 3			
992 M104	Operation panel setting dial push monitor selection	0 (set frequency)	0 to 3, 5 to 14, 17 to 20, 22 to 36, 38 to 46, 50 to 57, 61, 62, 64, 67, 71 to 75, 87 to 98, 100	Select the monitor item displayed on the operation panel at the time when the setting dial is pressed.
170 M020	Watt-hour meter clear	9999	0	Set "0" to clear the watt-hour meter.
			10	Set "10" to monitor the cumulative power in the range of 0 to 9999 kWh via communication.
			9999	Set "9999" to monitor the cumulative power in the range of 0 to 65535 kWh via communication.
563 M021	Energization time carrying-over times	0	(0 to 65535) (Read-only)	The number of times that the cumulative energization time exceeded 65535 hours is displayed (read-only).
268 M022	Monitor decimal digits selection	9999	0	Value is displayed in 1 increments (an integer).
			1	Value is displayed in 0.1 increments.
			9999	No function
891 M023	Cumulative power monitor digit shifted times	9999	0 to 4	Set the number of digits to move the decimal point of the cumulative energy monitored value to the left. The readout peaks out at the upper limit of readout.
			9999	The function of moving the decimal point is not available. The readout is reset to 0 when it exceeds the upper limit.
171 M030	Operation hour meter clear	9999	0	Set "0" to clear the operation hour meter.
			9999	The readout is always 9999. Nothing changes when "9999" is set.
564 M031	Operating time carrying-over times	0	(0 to 65535) (Read-only)	The number of times that the operating time reaches 65535 hours is displayed. Read-only.
290 M044	Monitor negative output selection	0	0 to 7	Set the availability of negative signals output via terminal AM, to the operation panel, and through communication. (Refer to <a href="#">page 455</a> .)
1018 M045	Monitor with sign selection	9999	0, 1, 9999	Select the item group to enable the indication of negative signed numbers.
1106 M050	Torque monitor filter	9999	0 to 5 s	The filter time constant is selectable for monitoring of the torque. A larger setting results in slower response.
			9999	0.3 s filter
1107 M051	Running speed monitor filter	9999	0 to 5 s	The filter time constant is selectable for monitoring of the running speed. A larger setting results in slower response.
			9999	0.08 s filter
1108 M052	Excitation current monitor filter	9999	0 to 5 s	The filter time constant is selectable for monitoring of the motor excitation current. A larger setting results in slower response.
			9999	0.3 s filter

### ◆ Monitor item list (Pr.52, Pr.774 to Pr.776, Pr.992)

- Use **Pr.52**, **Pr.774 to Pr.776**, or **Pr.992** to select the item to monitor on the operation panel or the parameter unit.
- Refer to the following table to find the setting value for each monitoring. The value in the Pr. setting column is set in each of the parameters for monitoring (**Pr.52**, **Pr.774 to Pr.776**, and **Pr.992**) to determine the monitored item. The value in the RS-485 column is used for the RS-485 communication special monitor selection. The value in the MODBUS RTU column is used for the MODBUS RTU real time monitor. (The items marked with "—" cannot be selected. The circle in the negative indication (-)<sup>\*1</sup> column indicates that the indication of negative signed numbers is available.)

Monitor item	Increment and unit	Pr. setting	RS-485	MODBUS RTU	Negative indication (-) <sup>*1</sup>	Description
Output frequency (speed) <sup>*18</sup>	0.01 Hz <sup>*17</sup>	1/0/100	H01	40201	○ <sup>*21</sup>	The inverter output frequency is displayed.
Output current <sup>*17*18</sup>	0.01/0.1 A <sup>*6</sup>	2/0/100	H02	40202		The inverter output current effective value is displayed.

Monitor item	Increment and unit	Pr. setting	RS-485	MODBUS RTU	Negative indication (-) <sup>*1</sup>	Description
Output voltage <sup>*7*18</sup>	0.1 V	3/0/100	H03	40203		The inverter output voltage is displayed.
Fault indication	—	0/100	—	—		Each of the last 8 faults is displayed individually.
Set frequency / motor speed setting	0.01 Hz <sup>*17</sup>	5 <sup>*2</sup>	H05	40205		The set frequency is displayed.
Operation speed	1 (r/min)	6 <sup>*2</sup>	H06	40206	○ <sup>*21</sup>	The motor speed is displayed (depending on the settings of <b>Pr.37</b> and <b>Pr.144</b> ). (Refer to <a href="#">page 444</a> .) During encoder feedback control operation or under Vector control, the actual motor speed according to encoder signals is displayed.
Motor torque	0.1%	7 <sup>*2</sup>	H07	40207	○	The motor torque is displayed as a percentage (0% under V/F control), considering the rated torque as 100%.
Converter output voltage <sup>*7</sup>	0.1 V	8 <sup>*2</sup>	H08	40208		The DC bus voltage value is displayed.
Regenerative brake duty <sup>*8</sup>	0.1%	9 <sup>*2</sup>	H09	40209		Brake duty set in <b>Pr.70</b> for the regeneration unit set in <b>Pr.30</b> is displayed.
Electronic thermal O/L relay load factor	0.1%	10 <sup>*2</sup>	H0A	40210		The motor thermal cumulative value is displayed, considering the thermal operation level as 100%.
Output current peak value <sup>*7</sup>	0.01/0.1 A <sup>*6</sup>	11 <sup>*2</sup>	H0B	40211		The peak value of output current, which is constantly stored, is displayed. (It is reset with every startup of the inverter.)
Converter output voltage peak value <sup>*7</sup>	0.1 V	12 <sup>*2</sup>	H0C	40212		The DC bus voltage peak value, which is constantly stored, is displayed. (It is reset with every startup of the inverter.)
Input power	0.01/0.1 kW <sup>*6</sup>	13 <sup>*2</sup>	H0D	40213		The power at the inverter input side is displayed.
Output power <sup>*9</sup>	0.01/0.1 kW <sup>*6</sup>	14 <sup>*2</sup>	H0E	40214		The power at the inverter output side is displayed.
Load meter	0.1%	17	H11	40217		Torque current is displayed as a percentage, considering <b>Pr.56</b> setting value as 100% (considering the motor rated torque as 100% under Real sensorless vector control or Vector control).
Motor excitation current <sup>*7</sup>	0.01 A/0.1 A <sup>*6</sup>	18	H12	40218		The motor excitation current is displayed.
Position pulse <sup>*11</sup>	—	19	H13	40219		The number of pulses per motor rotation during orientation control operation or in the position control mode is displayed. (The output voltage is displayed when a Vector control option is not installed.)
Cumulative energization time <sup>*3</sup>	1h	20	H14	40220		The cumulative energization time since the inverter shipment is displayed. The number of times an integrated value has reached the maximum value of 65535 hours can be checked in <b>Pr.563</b> .
Orientation status <sup>*11</sup>	1	22	H16	40222		Monitoring is enabled only during orientation control operation. (The output voltage is displayed when a Vector control option is not installed.) (Refer to <a href="#">page 585</a> .)
Actual operation time <sup>*3*4</sup>	1 h	23	H17	40223		The cumulative operation time is displayed. The number of times an integrated value has reached the maximum value of 65535 hours can be checked in <b>Pr.564</b> . Use <b>Pr.171</b> to reset the cumulative operation time. (Refer to <a href="#">page 454</a> .)
Motor load factor	0.1%	24	H18	40224		The output current value is displayed as a percentage, considering the inverter rated current value as 100%. Readout (%) = present output current value / inverter rated current value × 100
Cumulative energy <sup>*7</sup>	0.01/0.1 kWh <sup>*5*6</sup>	25	H19	40225		The cumulative energy based on the monitored output power is displayed. Use <b>Pr.170</b> to reset it. (Refer to <a href="#">page 454</a> .)
Position command (lower digits)	1	26	H1A	40226	○	The position command (decimal) before the electronic gear is set is displayed. <sup>*10</sup>
Position command (upper digits)	1	27	H1B	40227	○	

Monitor item	Increment and unit	Pr. setting	RS-485	MODBUS RTU	Negative indication (-) <sup>*11</sup>	Description
Current position (lower digits)	1	28	H1C	40228	○	The converted number of the position feedback pulse into the number of pulses before the electronic gear is set is displayed. <sup>*10</sup>
Current position (upper digits)	1	29	H1D	40229	○	
Droop pulse (lower digits)	1	30	H1E	40230	○	The droop pulse before the electronic gear is set is displayed. <sup>*10</sup>
Droop pulse (upper digits)	1	31	H1F	40231	○	
Torque command	0.1%	32	H20	40232	○	The torque command value adjusted with Vector control is displayed.
Torque current command	0.1%	33	H21	40233	○	The command value of the current for torque is displayed.
Motor output	0.01/0.1 kW <sup>*6</sup>	34	H22	40234		The output of a machine connected to the motor shaft is displayed. It is determined by multiplying the present output torque with the present motor speed.
Feedback pulse <sup>*11</sup>	—	35	H23	40235		The number of pulses fed back from the encoder in one cycle of the sampling is displayed (kept displayed during a stop). (The output voltage is displayed when a Vector control option is not installed.) The sampling time period varies depending on the <b>Pr.369 Number of encoder pulses</b> setting. 1050 or less: 1 s, 1051 to 2100: 0.5 s, 2101 to 4096: 0.25 s
Torque (positive polarity for driving torque/negative polarity for regenerative braking torque)	0.1%	36	H24	40236	○	The value equal to the motor torque is displayed. A positive value for driving torque or a negative value for regenerative braking torque is displayed.
Trace status	1	38	H26	40238		The trace status is displayed. (Refer to <a href="#">page 649.</a> )
SSCNET III communication status <sup>*11</sup>	1	39	H27	40239		The SSCNET III communication status between the inverter and the controller is displayed. The output voltage is displayed when the FR-A8NS is not installed.
PLC function user monitor 1	Increment set in the register SD1215	40	H28	40240		The user-designated monitor item is displayed using the PLC function. Each value of the following special registers is displayed. SD1216: displayed with the setting value "40", SD1217: displayed with the setting value "41", SD1218: displayed with the setting value "42" (Refer to the PLC Function Programming Manual.)
PLC function user monitor 2		41	H29	40241		
PLC function user monitor 3		42	H2A	40242		
Station number (RS-485 terminals)	1	43	H2B	40243		The station number of the inverter enabling communication via the RS-485 terminals is displayed.
Station number (PU)	1	44	H2C	40244		The station number of the inverter enabling communication via the PU connector is displayed.
Station number (CC-Link)	1	45	H2D	40245		The station number of the inverter enabling CC-Link communication is displayed. ("0" is displayed when the FR-A8NS is not installed.)
Motor temperature <sup>*11</sup>	1°C	46	H2E	40246	○	The temperature of the Vector control dedicated motor with thermistor (SF-V5RUJ[T/A]) is displayed (for the FR-A8AZ).
Power saving effect	Increment and unit vary depending on the parameter settings.	50	H32	40250		The energy saving effect monitoring is enabled. The item to monitor is selectable from among the saved power, the average energy saving, and the energy cost savings. Some of them can be displayed as a percentage according to the parameter settings. (Refer to <a href="#">page 467.</a> )
Cumulative energy saving		51	H33	40251		
PID set point	0.1%	52	H34	40252		The set point, measured value, and deviation during PID control operation is displayed. (Refer to <a href="#">page 610.</a> )
PID measured value	0.1%	53	H35	40253		
PID deviation	0.1%	54	H36	40254	○	



Monitor item	Increment and unit	Pr. setting	RS-485	MODBUS RTU	Negative indication (-) <sup>*1</sup>	Description
Input terminal status	—	55 <sup>*19</sup>	H0F <sup>*12</sup>	40215 <sup>*12</sup>		The ON/OFF state of the input terminals on the inverter is displayed. (Refer to <a href="#">page 453</a> for details on indication on the DU.)
Output terminal status	—		H10 <sup>*13</sup>	40216 <sup>*13</sup>		The ON/OFF state of the output terminals on the inverter is displayed. (Refer to <a href="#">page 453</a> for details on indication on the DU.)
Option input terminal status <sup>*11</sup>	—	56	—	—		The ON/OFF state of the input terminals on the digital input option (FR-A8AX) is displayed on the DU. (Refer to <a href="#">page 453</a> for details.)
Option output terminal status <sup>*11</sup>	—	57	—	—		The ON/OFF state of the output terminals on the digital output option (FR-A8AY) or the relay output option (FR-A8AR) is displayed on the DU. (Refer to <a href="#">page 453</a> for details.)
Option input terminal status 1 (for communication) <sup>*11</sup>	—	—	H3A <sup>*14</sup>	40258 <sup>*14</sup>		The ON/OFF state of the input terminals X0 to X15 on the digital input option (FR-A8AX) is monitored via RS-485 communication or other communication when the communication option is installed.
Option input terminal status 2 (for communication) <sup>*11</sup>	—	—	H3B <sup>*15</sup>	40259 <sup>*15</sup>		The ON/OFF state of the input terminal DY on the digital input option (FR-A8AX) is monitored via RS-485 communication or other communication when the communication option is installed.
Option output terminal status (for communication) <sup>*11</sup>	—	—	H3C <sup>*16</sup>	40260 <sup>*16</sup>		The ON/OFF state of the output terminals on the digital output option (FR-A8AY) or the relay output option (FR-A8AR) is monitored via RS-485 communication or other communication when the communication option is installed.
Motor thermal load factor	0.1%	61	H3D	40261		The accumulated heat value of the motor thermal O/L relay is displayed. The Motor overload trip (electronic thermal relay function) (E.THM) occurs at 100%.
Inverter thermal load factor	0.1%	62	H3E	40262		The accumulated heat value of the inverter thermal O/L relay is displayed. The Inverter overload trip (electronic thermal relay function) (E.THT) occurs at 100%.
PTC thermistor resistance	0.01 kΩ	64	H40	40264		The PTC thermistor resistance is displayed when <b>Pr.561 PTC thermistor protection level</b> ≠ 9999. (The output voltage is displayed when <b>Pr.561</b> = 9999.)
PID measured value 2	0.1%	67	H43	40267		The PID measured value is displayed while the PID control is enabled ( <b>Pr.128</b> ≠ "0"), even if PID control operating conditions are not satisfied. (Refer to <a href="#">page 610</a> .)
Cumulative pulse <sup>*11</sup>	—	71	H47	40271	○ <sup>*20</sup>	The cumulative number of pulses is displayed (for Vector control compatible plug-in option). (Monitoring range: -32767 to 32767)
Cumulative pulse overflow times <sup>*11</sup>	—	72	H48	40272	○ <sup>*20</sup>	The number of the cumulative pulses carrying overflow times is displayed (for Vector control compatible plug-in option).
Cumulative pulse (control terminal option) <sup>*11</sup>	—	73	H49	40273	○ <sup>*20</sup>	The cumulative number of pulses is displayed (for the FR-A8TP). (Monitoring range: -32767 to 32767)
Cumulative pulse overflow times (control terminal option) <sup>*11</sup>	—	74	H4A	40274	○ <sup>*20</sup>	The number of the cumulative pulse overflow times is displayed (for the FR-A8TP).
Multi-revolution counter <sup>*11</sup>	1	75	H4B	40275		The multi-revolution encoder counter is monitored when the FR-A8APS is installed. (The output voltage is monitored when the FR-A8APS is not installed.)

Monitor item	Increment and unit	Pr. setting	RS-485	MODBUS RTU	Negative indication (-) <sup>*1</sup>	Description
32-bit cumulative energy (lower 16 bits)	1 kWh	—	H4D	40277		The upper or lower 16 bits of the 32-bit cumulative energy is displayed on each indication. It is monitored via RS-485 communication or other communication with a communication option installed. (To find the monitor codes for each communication option, refer to the Instruction Manual of each communication option.)
32-bit cumulative energy (upper 16 bits)	1 kWh	—	H4E	40278		
32-bit cumulative energy (lower 16 bits)	0.01 kWh/0.1 kWh <sup>*6</sup>	—	H4F	40279		
32-bit cumulative energy (upper 16 bits)	0.01 kWh/0.1 kWh <sup>*6</sup>	—	H50	40280		
Remote output value 1	0.1%	87	H57	40287		Each setting value of <b>Pr.656 to Pr.659</b> (Analog remote output 1 to 4) is displayed. (Refer to <a href="#">page 490</a> .)
Remote output value 2	0.1%	88	H58	40288	○	
Remote output value 3	0.1%	89	H59	40289		
Remote output value 4	0.1%	90	H5A	40290		
PID manipulated amount	0.1%	91	H5B	40291	○	The PID control manipulated amount is displayed. (Refer to <a href="#">page 610</a> .)
Second PID set point	0.1%	92	H5C	40292		The set point, measured value, or deviation is displayed during the second PID control operation. (Refer to <a href="#">page 610</a> .)
Second PID measured value	0.1%	93	H5D	40293		
Second PID deviation	0.1%	94	H5E	40294	○	
Second PID measured value 2	0.1%	95	H5F	40295		The PID measured value is displayed while the second PID control is enabled ( <b>Pr.753</b> ≠ "0"), even if PID control operating conditions are not satisfied. (Refer to <a href="#">page 610</a> .)
Second PID manipulated amount	0.1%	96	H60	40296	○	The second PID control manipulated amount is displayed. (Refer to <a href="#">page 610</a> .)
Dancer main set speed	0.01 Hz.	97	H61	40297		The set speed for main speed during the dancer control operation is displayed.
Control circuit temperature	1°C	98	H62	40298	○	The temperature of the control circuit board is displayed. (Refer to <a href="#">page 494</a> .) When negative number not displayed: 0 to 100°C When negative number displayed: -20 to 100°C

\*1 Indication with a minus sign is not possible via RS-485 or MODBUS RTU communication.

\*2 To monitor the item on the LCD operation panel (FR-LU08) or the parameter unit (FR-PU07) in the monitor mode, use **Pr.774 to Pr.776** or the monitor function of the FR-LU08 or the FR-PU07 for setting.

\*3 The cumulative energization time and actual operation time are accumulated from 0 to 65535 hours, then cleared, and accumulated again from 0.

\*4 The actual operation time does not increase if the cumulative running time before power OFF is less than an hour.

\*5 On the parameter unit (FR-PU07), the unit "kW" is displayed.

\*6 The increment differs according to the inverter capacity. (Increment left of a slash for FR-A820-03160(55K) or lower, FR-A840-01800(55K) or lower. Increment right of a slash for FR-A820-03800(75K) or higher, FR-A840-02160(75K) or higher.)

\*7 Since each readout of the output voltage and output current displayed on the operation panel (FR-DU08) is a four-digit number, a value of more than 9999 is displayed as "----".

\*8 The setting is available for the standard model.

\*9 The inverter regards the output current which is less than the specified current level (5% of the rated inverter current) as 0 A. Therefore, each readout of an output current and output power may show "0" if a too small-capacity motor is used as contrasted with the inverter capacity and the output current falls below the specified value.

\*10 The displayed item can be changed to the pulse after the electronic gear is set by using **Pr.430 Pulse monitor selection**. (Refer to [page 321](#).)

\*11 Monitoring is available when the compatible plug-in option or control terminal option is installed.

\*12 The details of bits for the input terminal status are as follows. (1: ON state, 0: OFF state of a terminal on the inverter. "—" denotes an indefinite (null) value.)

b15															b0	
S1	S2	-	-	CS	RES	STP (STOP)	MRS	JOG	RH	RM	RL	RT	AU	STR	STF	

\*13 The details of bits for the output terminal status are as follows. (1: ON state, 0: OFF state of a terminal on the inverter. "—" denotes an indefinite (null) value.)

b15															b0		
-	-	-	-	-	-	-	-	-	So (SO)	ABC2	ABC1	FU	OL	IPF	SU	RUN	



\*14 The details of bits for the option input terminal status 1 are as follows. (1: ON state, 0: OFF state of a terminal on the FR-A8AX.) Every bit is 0 (OFF) when the option is not installed.

b15														b0	
X15	X14	X13	X12	X11	X10	X9	X8	X7	X6	X5	X4	X3	X2	X1	X0

\*15 The details of bits for the option input terminal status 2 are as follows. (1: ON state, 0: OFF state of a terminal on the FR-A8AX. "-" denotes an indefinite (null) value.) Every bit is 0 (OFF) when the option is not installed.

b15														b0	
-	-	-	-	-	-	-	-	-	-	-	-	-	-	-	DY

\*16 The details of bits for the option output terminal status are as follows. (1: ON state, 0: OFF state of a terminal on the FR-A8AY/A8AR. "-" denotes an indefinite (null) value.) Every bit is 0 (OFF) when the option is not installed.

b15														b0	
-	-	-	-	-	-	RA3	RA2	RA1	Y6	Y5	Y4	Y3	Y2	Y1	Y0

\*17 The increment is 1 when Pr.37 = "1 to 9998" or when Pr.144 = "2 to 12" or "102 to 112". (Refer to page 444.)



\*18 The monitored values are retained even if an inverter fault occurs. Resetting clears the retained values.

\*19 Parameter setting is not available for setting the item as the main monitor item on the LCD operation panel (FR-LU08) or the parameter unit (FR-PU07). Use the monitor function of the FR-LU08 or the FR-PU07 for setting.

\*20 Negative values are not displayed on the operation panel. The values "-1 to -32767" are displayed as "65535 to 32769" on the operation panel.

\*21 Setting of Pr.1018 Monitor with sign selection is required. Also, it will be displayed without a minus sign on the operation panel. Confirm the rotation direction with the [FWD] or [REV] indicator.

## ◆ Monitor display for operation panel (Pr.52, Pr.774 to Pr.776)

- When Pr.52 = "0" (initial value), the monitoring of output frequency, output current, output voltage and fault display can be selected in sequence by pressing .
- Among the items set in Pr.52, the load meter and motor load factor are displayed in the second screen (initially set to monitor the output current). Other items are displayed in the third screen (initially set to monitor the output voltage).
- The first screen (initially set to monitor the output frequency) is displayed at power-ON in the initial setting. To change the screen displayed at power-ON, display the screen you want to display at power-ON, and hold down  for 1 second.

To monitor the output frequency at power-ON again, display the screen of output frequency, and hold down  for 1 second.

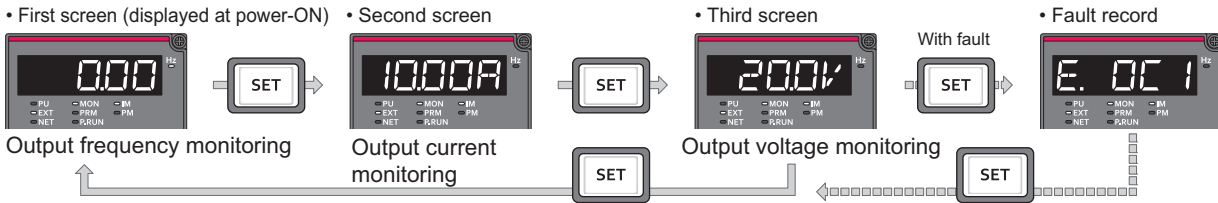

The following is the screen flow diagram when Pr.52 = "20" (cumulative energization time).

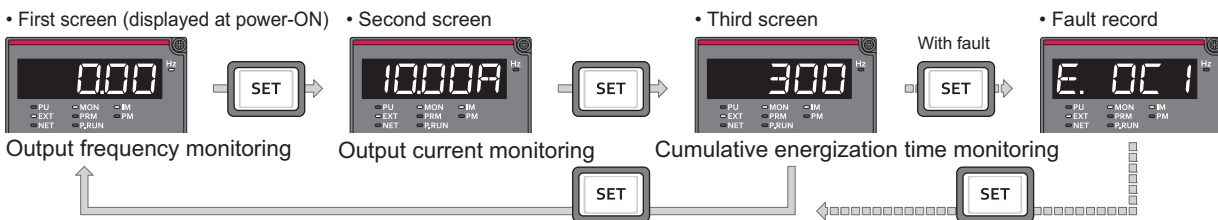

- The monitor item to be displayed is set using Pr.774 for the first screen, Pr.775 for the second screen, and Pr.776 for the third screen. When Pr.774 to Pr.776 = "9999" (initial value), the Pr.52 setting value is used.

### NOTE

- On the operation panel (FR-DU08), the "Hz" unit indicator is lit while displaying the output frequency, the "Hz" blinks when displaying the set frequency.

## ◆ Displaying the set frequency during stop (Pr.52)

- When Pr.52 = "100", the set frequency is displayed during stop, and output frequency is displayed during running. (LED of Hz blinks during stop and is lit during operation.)

Pr.52 setting	Status	Output frequency	Output current	Output voltage	Fault monitor
0	During running/ stop	Output frequency	Output current	Output voltage	Fault monitor
100	During stop	Set frequency <sup>*1</sup>			
	During running	Output frequency			

\*1 Displays the frequency that is output when the start command is ON. The value considers the maximum/minimum frequency and frequency jumps. It is different from the frequency setting displayed when Pr.52 = "5".

### NOTE

- During an error, the output frequency at error occurrence appears.
- During output shutoff by the MRS signal, the values displayed are the same as during a stop.
- During offline auto tuning, the tuning state monitor takes priority.

## ◆ Operation panel setting dial push display (Pr.992)

- Use Pr.992 to select the monitor that appears when the setting dial on the operation panel (FR-DU08) is pushed.
- When Pr.992 = "0 (initial value)", keep pressing the setting dial when in PU operation mode or External/PU combined operation mode 1 (Pr.79 Operation mode selection = "3") to show the presently set frequency.
- When Pr.992 = "100", the set frequency is displayed during stop, and output frequency is displayed during running.

Pr.992 setting	Status	Monitor displayed by the setting dial push
0	During running/stop	Set frequency (PU direct-in frequency)
100	During stop	Set frequency <sup>*1</sup>
	During running	Output frequency

\*1 Displays the frequency that is output when the start command is ON. The value considers the maximum/minimum frequency and frequency jumps. It is different from the frequency setting displayed when Pr.992 = "5".

## ◆ Monitoring I/O terminals on the operation panel (FR-DU08) (Pr.52, Pr.774 to Pr.776, Pr.992)

- When Pr.52 (Pr.774 to Pr.776, Pr.992) = "55 to 57", the I/O terminal state can be monitored on the operation panel (FR-DU08).
- When a terminal is ON, the corresponding LED segment is ON. The center LED segments are always ON.

Pr.52, Pr.774 to Pr.776, Pr.992 setting	Monitor item	Monitor description
55	I/O terminal status	Displays the I/O terminal ON/OFF state of the inverter.
56 <sup>*1</sup>	Option input terminal status	Displays input terminal ON/OFF state of the digital input option (FR-A8AX)
57 <sup>*1</sup>	Option output terminal status	Displays output terminal ON/OFF state of the digital output option (FR-A8AY) or the relay output option (FR-A8AR).

\*1 The setting value "56 or 57" can be set even if the option is not installed. All are OFF when the option is not connected.

- On the I/O terminal monitor, the upper LEDs indicate the input terminal status, and the lower LEDs indicate the output terminal status.

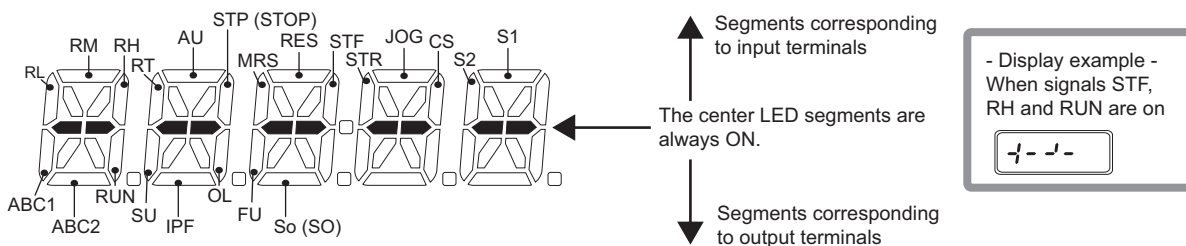

- The decimal point of the last digit on the LED is lit for the input option terminal monitor.

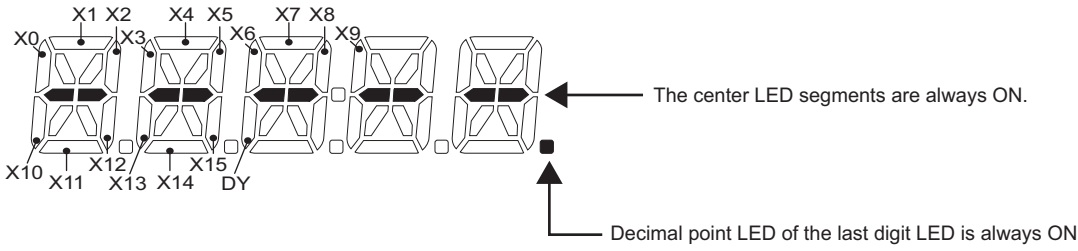

- The decimal point of the second last digit on the LED is lit for the output option terminal monitor.

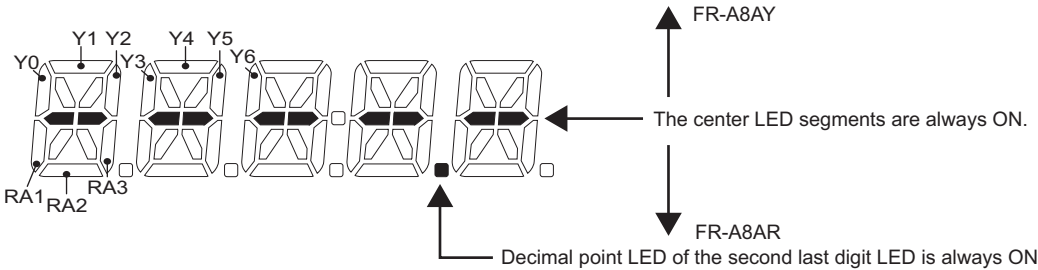

## ◆ Monitoring and resetting cumulative power (Pr.170, Pr.891)

- When the cumulative power is monitored (Pr.52 = "25"), the output power monitor value is added up and is updated in 100 ms increments.
- The values are stored in EEPROM every 10 minutes. The values are also stored in EEPROM at power OFF or inverter reset.
- Increments and ranges of monitoring on the operation panel or parameter unit and via communication (RS-485 communication or other communication with communication option installed) are as follows (when Pr.891 = "9999 (initial value)").

On operation panel or parameter unit <sup>*1</sup>		Via communication		
Range	Increment	Range		Increment
		Pr.170 = "10"	Pr.170 = "9999"	
0 to 999.99 kWh	0.01 kWh <sup>*2</sup>	0 to 9999 kWh	0 to 65535 kWh (initial value)	1 kWh
1000.0 to 9999.9 kWh	0.1 kWh			
10000 to 99999 kWh	1 kWh			

\*1 For the FR-A820-03160(55K) or lower and FR-A840-01800(55K) or lower, the value is measured in 0.01 kWh increments and the upper five digits are displayed. For the FR-A820-03800(75K) or higher and FR-A840-02160(75K) or higher, the value is measured in 0.1 kWh increments and the upper five digits are displayed.

For the FR-A820-03160(55K) or lower and FR-A840-01800(55K) or lower, the cumulative energy up to 999.99 kWh is displayed in 0.01 increments such as "999.99", and that of 1000 kWh or more is displayed in 0.1 increments such as "1000.0".

\*2 The display in 0.01 kWh increments is available only for the FR-A820-03160(55K) or lower and FR-A840-01800(55K) or lower.

- The decimal point position on the watt-hour meter can be shifted to left. The number of digits to be shifted is equal to the setting of Pr.891 Cumulative power monitor digit shifted times. For example, when Pr.891 = "2", the cumulative power value 1278.56 kWh is displayed as 12.78 (in 100 kWh increments) on the operation panel, or displayed as 12 on a display used for monitoring via communication.
- When Pr.891 = "0 to 4", the meter stops at the maximum number. When Pr.891 = "9999", the meter returns to 0 and the counting starts again.
- Writing "0" in Pr.170 clears the cumulative power monitor.

### NOTE

- When Pr.170 is read just after "0" has been written in Pr.170, the setting "9999" or "10" is displayed.

## ◆ Monitoring cumulative energization time (Pr.563)

- When the cumulative energization time is selected as a monitor item (Pr.52 = "20"), the counter of cumulative energization time since the inverter shipment accumulated every hour is displayed.
- The cumulative energization time is displayed in 0.001-hour increments until the cumulative time reaches one hour, and then the time is displayed in 1-hour increments.

- The EEPROM is updated every minute until the cumulative energization time reaches one hour, and then the EEPROM is updated every 10 minutes. The EEPROM is also updated at power OFF.
- When the cumulative energization time counter reaches 65535, it starts from 0 again. The number of times the cumulative energization time counter reaches 65535 can be checked with **Pr.563**.

**NOTE**

- The cumulative energization time does not increase if the power is turned OFF after less than an hour.

**◆ Actual operation time monitoring (Pr.171, Pr.564)**

- On the actual operation time monitoring (**Pr.52 = "23"**), the inverter running time is added up every hour. (Time is not added up during a stop.)
- The time is displayed in 1-hour increments.
- The values are stored in EEPROM every 10 minutes. The EEPROM is also updated at power OFF.
- When the cumulative energization time counter reaches 65535, it starts from 0 again. The number of times the actual operation time counter reaches 65535 can be checked with **Pr.564**.
- Setting "0" in **Pr.171** clears the actual operation time meter.

**NOTE**

- The actual operation time does not increase if the cumulative running time before power OFF is less than an hour.
- Once "0" is set in **Pr.171**, the setting of **Pr.171** is always turned to "9999" afterwards. Setting "9999" does not clear the actual operation time meter.

**◆ Hiding the decimal places for the monitors (Pr.268)**

- The numerical figures after a decimal point displayed on the operation panel may fluctuate during analog input, etc. The decimal places can be hidden by selecting the decimal digits with **Pr.268**.

Pr.268 setting	Description
9999 (initial value)	No function
0	For the first or second decimal places (0.1 increments or 0.01 increments) of the monitor, numbers in the first decimal place and smaller are rounded to display an integral value (1 increments). The monitor value equal to or smaller than 0.99 is displayed as 0.
1	When monitoring with the second decimal place (0.01 increments), the 0.01 decimal place is dropped and the monitor displays the first decimal place (0.1 increments). When monitoring with the first decimal place, the display will not change.

**NOTE**

- The number of readout digits of the cumulative energization time (**Pr.52 = "20"**), actual operation time (**Pr.52 = "23"**), cumulative energy (**Pr.52 = "25"**), and cumulative energy saving (**Pr.52 = "51"**) does not change.

**◆ Enabling display of negative numbers during monitoring (Pr.290)**

- Negative signal outputs can be selected for the items monitored via terminal AM (analog voltage output), via a communication option, and on the operation panel. To check which items can be monitored with indication of negative numbers, refer to the monitor items list (on [page 447](#)).

Pr.290 setting	Negative indication (-)			
	Terminal AM	Operation panel	Communication option <sup>*1</sup>	FR Configurator2 etc. <sup>*2</sup>
0 (initial value)	—	—	—	—
1	Enabled	—	—	—
2	—	Enabled	—	—
3	Enabled	Enabled	—	—
4	—	—	Enabled	Enabled
5	Enabled	—	Enabled	Enabled
6	—	Enabled	Enabled	Enabled
7	Enabled	Enabled	Enabled	Enabled

—: Negative numbers indication disabled (positive only)

\*1 Indication with a minus sign is not possible via the following communication methods.  
RS-485 communication (Mitsubishi inverter protocol, MODBUS RTU), SLMP communication

\*2 Under the condition that the high-speed sampling and the negative output are selected for FR Configurator2, the display range of the output frequency (Monitor No.1) is -300.00 to 300.00 Hz.

A value outside the range is clamped at -300.00 Hz or 300.00 Hz. Under the same condition, the display range of the running speed (Monitor No.6) is -30000 to 30000 r/min. A value outside the range is clamped at -30000 r/min or 30000 r/min. During the trace sampling, the same display ranges are applied. A value outside the ranges is clamped.

- Select the item group to enable the indication of negative signed numbers by setting **Pr.1018 Monitor with sign selection**.

Monitor item	Pr.1018 setting		
	9999	0	1
Output frequency	—	○ <sup>*1</sup>	○ <sup>*1</sup>
Motor speed	—	○ <sup>*1</sup>	○ <sup>*1</sup>
Motor torque	○	○	○
Position command (lower) <sup>*4</sup>	○ <sup>*2</sup>	○ <sup>*2</sup>	○ <sup>*3</sup>
Position command (upper) <sup>*4</sup>	○ <sup>*2</sup>	○ <sup>*2</sup>	○ <sup>*3</sup>
Current position (lower) <sup>*4</sup>	○ <sup>*2</sup>	○ <sup>*2</sup>	○ <sup>*3</sup>
Current position (upper) <sup>*4</sup>	○ <sup>*2</sup>	○ <sup>*2</sup>	○ <sup>*3</sup>
Droop pulse (lower) <sup>*4</sup>	○ <sup>*2</sup>	○ <sup>*2</sup>	○ <sup>*3</sup>
Droop pulse (upper) <sup>*4</sup>	○ <sup>*2</sup>	○ <sup>*2</sup>	○ <sup>*3</sup>
Torque command	○	○	○
Torque current command	○	○	○
Torque (positive polarity for driving torque/negative polarity for regenerative braking torque)	○	○	○
Motor temperature	○	○	○
PID deviation	○	○	○
Cumulative pulse	○	○	○
Cumulative pulse overflow times	○	○	○
Cumulative pulse (control terminal option)	○	○	○
Cumulative pulse overflow times (control terminal option)	○	○	○
Remote output 1	○	○	○
Remote output 2	○	○	○
Remote output 3	○	○	○
Remote output 4	○	○	○
PID manipulated amount	○	○	○
Second PID deviation	○	○	○
Second PID manipulated amount	○	○	○
Control circuit temperature	○	○	○

○: Negative numbers displayed with minus sign, —: Negative numbers not displayed (positive only)

\*1 Negative numbers are not displayed on the operation panel. Confirm the rotation direction with the [FWD] or [REV] indicator.

\*2 Signed values are displayed only on the FR-DU08 (-9999 to 9999). Unsigned values (0 to 9999) are displayed on other devices.

\*3 Full 32-bit data (-2147483648 to 2147483647) is displayed during monitoring via the communication option.

\*4 Monitor the lower and upper digits at the same timing. Otherwise, the data may not be reliable.

## NOTE

- When the output via terminal AM (analog voltage output) is set to "Negative numbers indication enabled", the output is within the range of -10 to +10 VDC. Connect the meter with which output level is matched.
- Parameter unit (FR-PU07) displays only positive values.

## ◆ Monitor filter (Pr.1106 to Pr.1108)

- The response level (filter time constant) of the following monitor indicators can be adjusted. Increase the setting when a monitor indicator is unstable, for example.

Pr.	Monitor number	Monitor indicator name
1106	7	Motor torque
	17	Load meter
	32	Torque command
	33	Torque current command
	36	Torque monitor
1107	6	Motor speed
1108	18	Motor excitation current

### « Parameters referred to »

Pr.30 Regenerative function selection, Pr.70 Special regenerative brake duty [page 724](#)

Pr.37 Speed display, Pr.144 Speed setting switchover [page 444](#)

Pr.55 Frequency monitoring reference, Pr.56 Current monitoring reference, Pr.866 Torque monitoring reference [page 457](#)

## 5.11.3 Monitor display selection for terminals FM/CA and AM

Monitored values are output in either of the following: analog voltage (terminal AM), pulse train (terminal FM) for the FM type inverter, or analog current (terminal CA) for the CA type inverter.

The signal (monitor item) to be output to terminal FM/CA and terminal AM can be selected.

Pr.	Name	Initial value		Setting range	Description	
		FM	CA			
<b>54</b> <b>M300</b>	<b>FM/CA terminal function selection</b>	1 (output frequency)		1 to 3, 5 to 14, 17, 18, 21, 24, 32 to 34, 36, 46, 50, 52 to 53, 61, 62, 67, 70, 87 to 90, 92, 93, 95, 97, 98	Select the item monitored via terminal FM or CA.	
<b>158</b> <b>M301</b>	<b>AM terminal function selection</b>			1 to 3, 5 to 14, 17, 18, 21, 24, 32 to 34, 36, 46, 50, 52 to 54, 61, 62, 67, 70, 87 to 98	Select the item monitored via terminal AM.	
<b>55</b> <b>M040</b>	<b>Frequency monitoring reference</b>	60 Hz	50 Hz	0 to 590 Hz	Set the full-scale value when outputting the frequency monitor value to terminals FM, CA and AM.	
<b>56</b> <b>M041</b>	<b>Current monitoring reference</b>	Inverter rated current		0 to 500 A <sup>*1</sup> 0 to 3600 A <sup>*2</sup>	Enter the full-scale value of a meter which corresponds to the output via terminal FM/CA or terminal AM to monitor the output current.	
<b>866</b> <b>M042</b>	<b>Torque monitoring reference</b>	150%		0 to 400%	Enter the full-scale value of a meter which corresponds to the output via terminal FM/CA or terminal AM to monitor the motor torque.	
<b>290</b> <b>M044</b>	<b>Monitor negative output selection</b>	0		0 to 7	Set the availability of negative signals output via terminal AM, to the operation panel, and through communication. (Refer to <a href="#">page 455</a> .)	
<b>291</b> <b>D100</b>	<b>Pulse train I/O selection</b>	0			<b>Pulse train input (terminal JOG)</b>	<b>Pulse train output (terminal FM)</b>
				0	JOG signal <sup>*3</sup>	FM output <sup>*4</sup>
				1	Pulse train input	FM output <sup>*4</sup>
				10 <sup>*4</sup>	JOG signal <sup>*3</sup>	High-speed pulse train output (50% duty)
				11 <sup>*4</sup>	Pulse train input	High-speed pulse train output (50% duty)
				20 <sup>*4</sup>	JOG signal <sup>*3</sup>	High-speed pulse train output (ON width fixed)
				21 <sup>*4</sup>	Pulse train input	High-speed pulse train output (ON width fixed)
100 <sup>*4</sup>	Pulse train input	High-speed pulse train output (ON width fixed). Output the pulse train input without changes.				

\*1 For the FR-A820-03160(55K) or lower, and FR-A840-01800(55K) or lower.

\*2 For the FR-A820-03800(75K) or higher, and FR-A840-02160(75K) or higher.

\*3 Function assigned to **Pr.185 JOG terminal function selection**.

\*4 Valid only for the FM type inverters.

## ◆ Monitor description list (Pr.54, Pr.158)

- Set **Pr.54 FM/CA terminal function selection** for monitoring via terminal FM (pulse train output) or terminal CA (analog current output).
- Set **Pr.158 AM terminal function selection** for monitoring via terminal AM (analog voltage output). Negative signals can be output via terminal AM (in the range of -10 to +10 VDC). The circle in the Negative output column indicates that the output of negative signals is available via terminal AM. (To enable or disable the output of negative signals, refer to [page 446](#).)
- Refer to the following table and select the item to be monitored. (Refer to [page 447](#) for the list of monitor items.)

Monitor item	Increment and unit	Pr.54 (FM/CA), Pr.158 (AM) setting	Terminal FM, CA, AM full-scale value	Negative (-) output	Remarks
Output frequency	0.01 Hz	1	<b>Pr.55</b>	○ <sup>*3</sup>	
Output current <sup>*2</sup>	0.01/0.1 A <sup>*1</sup>	2	<b>Pr.56</b>		
Output voltage	0.1 V	3	200 V class: 400 V, 400 V class: 800 V		
Frequency setting value	0.01 Hz	5	<b>Pr.55</b>		

Monitor item	Increment and unit	Pr.54 (FM/CA), Pr.158 (AM) setting	Terminal FM, CA, AM full-scale value	Negative (-) output	Remarks
Motor speed	1 (r/min)	6	The value converted with the Pr.37, Pr.144 value from Pr.55.	○*3	Refer to page 444 for the monitoring of the operation speed.
Motor torque	0.1%	7	Pr.866	○	
Converter output voltage*2	0.1 V	8	200 V class: 400 V, 400 V class: 800 V		
Regenerative brake duty*4	0.1%	9	Brake duty decided by Pr.30, Pr.70.		
Electronic thermal O/L relay load factor	0.1%	10	Electronic thermal O/L relay (100%)		
Output current peak value	0.01/0.1 A*1	11	Pr.56		
Converter output voltage peak value	0.1 V	12	200 V class: 400 V, 400 V class: 800 V		
Input power	0.01/0.1 kW*1	13	Inverter rated power × 2		
Output power*2	0.01/0.1 kW*1	14	Inverter rated power × 2		
Load meter	0.1%	17	Pr.866		
Motor excitation current	0.01 A/0.1 A*1	18	Pr.56		
Reference voltage output	—	21	—		Terminal FM: When Pr.291 = "0 or 1", output is 1440 pulses/s. When Pr.291 ≠ "0 or 1", output is 50k pulses/s. Terminal CA: Output is 20 mA. Terminal AM: Output is 10 V.
Motor load factor	0.1%	24	200%		
Torque command	0.1%	32	Pr.866	○	
Torque current command	0.1%	33	Pr.866	○	
Motor output	0.01/0.1 kW*1	34	Rated motor capacity		
Torque (positive polarity for driving torque/ negative polarity for regenerative braking torque)	0.1%	36	Pr.866	○	
Motor temperature	1°C	46	Pr.751	○	Enabled when the FR-A8AZ is used.
Energy saving effect	Increment and unit vary depending on the parameter settings.	50	Inverter capacity		For the information of the power saving effect monitoring, refer to page 467.
PID set point	0.1%	52	100%		
PID measured value	0.1%	53	100%		
PID deviation	0.1%	54*5	100%	○	Refer to page 610 for the PID control.
Motor thermal load factor	0.1%	61	Motor thermal activation level (100%)		
Inverter thermal load factor	0.1%	62	Inverter thermal activation level (100%)		
PID measured value 2	0.1%	67	100%		Refer to page 610 for the PID control.
PLC function analog output	0.1%	70	100%	○	Enabled by Pr.414 = "1 or 2". Refer to page 646 for the PLC function.
Remote output value 1	0.1%	87	1000%		
Remote output value 2	0.1%	88	1000%		
Remote output value 3	0.1%	89	1000%		
Remote output value 4	0.1%	90	1000%		Refer to page 490 for the analog remote output.



Monitor item	Increment and unit	Pr.54 (FM/CA), Pr.158 (AM) setting	Terminal FM, CA, AM full-scale value	Negative (-) output	Remarks
PID manipulated amount	0.1%	91 <sup>*5</sup>	100%	○	Refer to <a href="#">page 610</a> for the PID control.
Second PID set point	0.1%	92	100%		
Second PID measured value	0.1%	93	100%		
Second PID deviation	0.1%	94 <sup>*5</sup>	100%	○	
Second PID measured value 2	0.1%	95	100%		
Second PID manipulated amount	0.1%	96 <sup>*5</sup>	100%	○	
Dancer main speed setting	0.01 Hz.	97	<b>Pr.55</b>		For details on dancer control, refer to <a href="#">page 622</a> .
Control circuit temperature	1°C	98	100°C	○	Terminal FM/CA: 0 to 100°C, Terminal AM: -20 to 100°C

\*1 The increment differs according to the inverter capacity. (Increment left of a slash for FR-A820-03160(55K) or lower, FR-A840-01800(55K) or lower. Increment right of a slash for FR-A820-03800(75K) or higher, FR-A840-02160(75K) or higher.)

\*2 The inverter regards the output current which is less than the specified current level (5% of the rated inverter current) as 0 A. Therefore, each readout of an output current and output power may show "0" if a too small-capacity motor is used as contrasted with the inverter capacity and the output current falls below the specified value.

\*3 Setting of **Pr.1018 Monitor with sign selection** is required.

\*4 This signal is available only for the standard model.

\*5 The setting is available only in **Pr.158** (terminal AM).

## ◆ Frequency monitor reference (Pr.55)

- Enter the full scale value of a meter used to monitor the output frequency, the frequency setting value, or the dancer main speed setting via terminal FM/CA or terminal AM.
- For the FM type inverter, enter the full-scale value of the meter corresponding to a pulse train of 1440 pulses/s (or 50k pulses/s) output via terminal FM. Enter the frequency value (for example, 60 Hz or 120 Hz) at full scale of the meter (1 mA analog meter) installed between terminal FM and terminal SD. Pulse speed is proportional to the output frequency of the inverter. (The maximum output pulse train is 2400 pulses/s (or 55k pulses/s).)

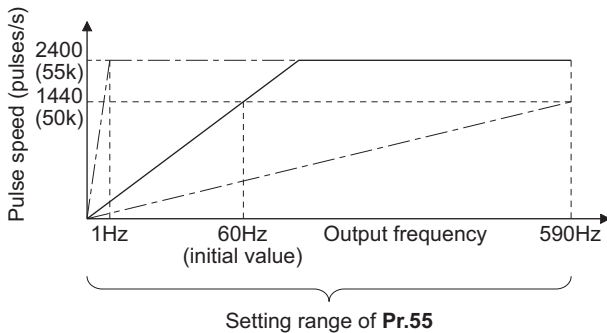

- For the CA type inverter, enter the full-scale value of the meter corresponding to a current of 20 mADC output via terminal CA. Enter the current value (for example, 60 Hz or 120 Hz) at full scale of the meter (20 mADC ammeter) installed between terminal CA and terminal 5. Output current is proportional to the frequency. (The maximum output current is 20 mADC.)

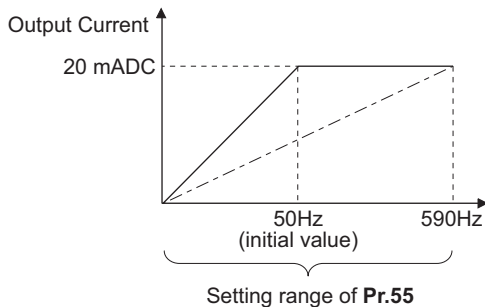

- Enter the full-scale value of the meter corresponding to a voltage of 10 VDC output via terminal AM. Enter the current value (for example, 60 Hz or 120 Hz) at full scale of the meter (10 VDC voltmeter) installed between terminal AM and terminal 5. Output voltage is proportional to the frequency. (The maximum output voltage is 10 VDC.)

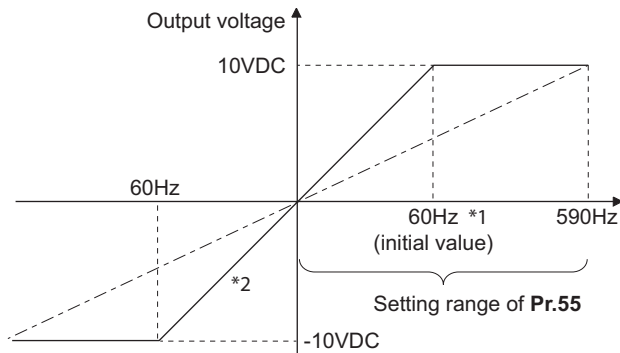

\*1 FM type: 60 Hz, CA type: 50 Hz

\*2 Output of negative signals enabled when **Pr.290 Monitor negative output selection** = "1 or 3"

### ◆ Current monitor reference (Pr.56)

- Enter the full scale value of a meter used to monitor the output current, the output current peak value, or the motor excitation current via terminal FM/CA or terminal AM.
- For the FM type inverter, enter the full-scale value of the meter corresponding to a pulse train of 1440 pulses/s (or 50k pulses/s) output via terminal FM. Enter the current value at full scale of the meter (1 mA analog meter) installed between terminal FM and terminal SD. Pulse speed is proportional to the output current monitored. (The maximum output pulse train is 2400 pulses/s (or 55k pulses/s).)
- For the CA type inverter, enter the full-scale value of the current meter corresponding to a current of 20 mADC output via terminal CA. Enter the current value at full scale of the meter (20 mADC ammeter) installed between terminal CA and terminal 5. Output current is proportional to the output current monitored. (The maximum output current is 20 mADC.)
- Enter the full-scale value of the current meter corresponding to a voltage of 10 VDC output via terminal AM. Enter the current value at full scale of the meter (10 VDC voltmeter) installed between terminal AM and terminal 5. Output voltage is proportional to the output current monitored. (The maximum output voltage is 10 VDC.)

### ◆ Torque monitor reference (Pr.866)

- Enter the full scale value of a meter used to monitor the output torque via terminal FM/CA or terminal AM.
- For the FM type inverter, enter the full-scale value of the torque meter corresponding to a pulse train of 1440 pulses/s (or 50k pulses/s) output via terminal FM. Enter the torque value at full scale of the meter (1 mA analog meter) installed between terminal FM and terminal SD. Pulse speed is proportional to the torque monitored. (The maximum output pulse train is 2400 pulses/s (or 55k pulses/s).)
- For the CA type inverter, enter the full-scale value of the torque meter corresponding to a current of 20 mADC output via terminal CA. Enter the torque value at full scale of the meter (20 mADC ammeter) installed between terminal CA and terminal 5. Output current is proportional to the torque monitored. (The maximum output voltage is 20 mADC.)
- Enter the full-scale value of the torque meter corresponding to a voltage of 10 VDC output via terminal AM. Enter the torque value at full scale of the meter (10 VDC voltmeter) installed between terminal AM and terminal 5. Output voltage is proportional to the torque monitored. (The maximum output voltage is 10 VDC.)

### ◆ Terminal FM pulse train output (Pr.291)

- Two kinds of pulse trains can be outputted via terminal FM.
- When **Pr.291 Pulse train I/O selection** = "0 (initial value) or 1", pulse train is output via terminal FM, with a maximum output of 8 VDC and 2400 pulses/s.  
The pulse width can be adjusted on the operation panel or the parameter unit by using the calibration parameter **C0 (Pr.900) FM/CA terminal calibration**.
- A 1 mA full-scale DC ammeter or a digital meter can be used to give commands (such as inverter output frequency command).

### FM output circuit

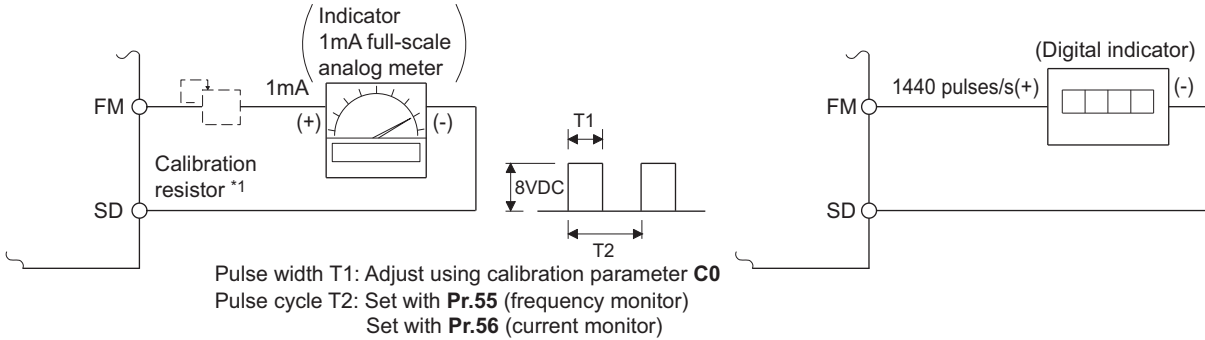
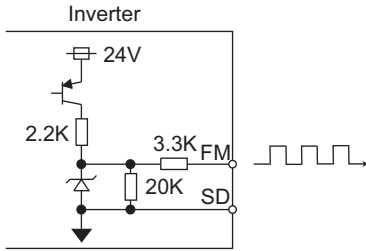

\*1 Not needed when the operation panel or the parameter unit is used for calibration.

Use a calibration resistor when the indicator (frequency meter) needs to be calibrated by a neighboring device because the indicator is located far from the inverter.

However, the frequency meter needle may not deflect to full-scale if the calibration resistor is connected. In this case, calibrate additionally with the operation panel or parameter unit.

\*2 In the initial setting, 1 mA full-scale and 1440 pulses/s terminal FM are used at 60 Hz.

- When **Pr.291 Pulse train I/O selection** = "10, 11, 20, 21, or 100", this is high-speed pulse train output for open collector output. A maximum pulse train of 55k pulses/s is outputted. There are two types of pulse width: "50% duty" and "fixed ON width"; this cannot be adjusted with the calibration parameter **C0 (Pr.900) FM/CA terminal calibration**.

### High-speed pulse train output circuit (example of connection to pulse counter)

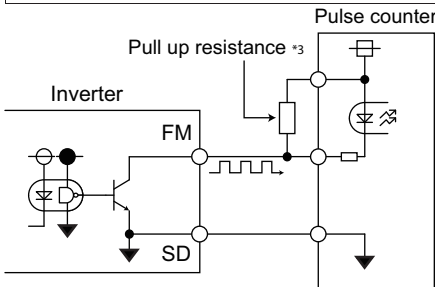

\*1 The pulses may weaken due to stray capacitance in the wiring if the wiring is long, and the pulse counter will be unable to recognize the pulses. Connect the open collector output to the power source with a pull-up resistor if the wiring is too long.

Check the pulse counter specs for the pull-up resistance.

The resistance should be at 80 mA of the load current or less.

- When **Pr.291** = "10, or 11", the pulse cycle is 50% duty (ON width and OFF width are the same).
- When **Pr.291** = "20, 21, or 100", the pulse ON width is output at a fixed width (approx. 10  $\mu$ s).
- At the "100" setting, the same pulse train from the pulse train input (terminal JOG) will be outputted. This is used when running at a synchronized speed with more than one inverter. (Refer to [page 406](#).)

#### Pulse of Pr.291 = "10, 11"



#### Pulse of Pr.291 = "20, 21, 100"



\*1 "HIGH" indicates when the open collector output transistor is OFF.

Item	High-speed pulse train output specifications
Output method	NPN open collector output
Voltage between collector-emitter	30 V (max.)
Maximum permissible load current	80 mA
Output pulse rate	0 to 55k pulses/s <sup>*1</sup>
Output resolution	3 pulses/s (excluding jitter)

\*1 50k pulses/s when the monitor output value is 100%.

## NOTE

- Terminal JOG input specifications (pulse train input or contact input) can be selected with **Pr.291**. When changing the setting value, be careful not to change the terminal JOG input specifications. (Refer to [page 406](#) for pulse train input.)
- Install a meter between terminals FM and SD after changing the **Pr.291** setting value. During output the pulse train via terminal FM (voltage output), be careful that voltage is not added to terminal FM.
- The meter cannot be used for the pulse input in a source logic type.
- If the All parameter clear is performed when the high-speed pulse train output is selected (**Pr.291** = "10, 11, 20, 21, or 100"), the output via terminal FM is changed from high-speed pulse train output to the voltage output because the **Pr.291** setting resets to the initial value "0". To perform the All parameter clear, remove the device connected to terminal FM first.

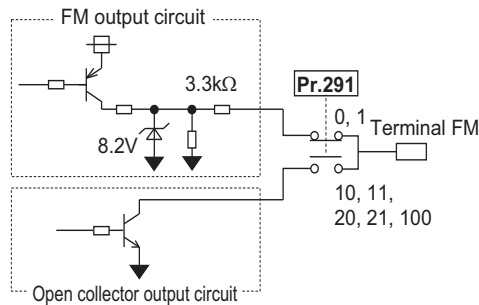

## 5.11.4 Adjustment of terminal FM/CA and terminal AM

The output via terminal FM/CA or terminal AM corresponding to the full-scale value of a meter can be adjusted (calibrated) on the operation panel or the parameter unit.

Pr.	Name	Initial value	Setting range	Description
<b>C0</b> (900) <b>M310</b> <sup>*1</sup>	<b>FM/CA terminal calibration</b>	—	—	Calibrates the scale of the meter connected to terminals FM and CA.
<b>C1</b> (901) <b>M320</b> <sup>*1</sup>	<b>AM terminal calibration</b>	—	—	Calibrates the scale of the analog meter connected to terminal AM.
<b>C8</b> (930) <b>M330</b> <sup>*1</sup>	<b>Current output bias signal</b>	0%	0 to 100%	Set the signal value at the minimum analog current output.
<b>C9</b> (930) <b>M331</b> <sup>*1</sup>	<b>Current output bias current</b>	0%	0 to 100%	Set the current value at the minimum analog current output.
<b>C10</b> (931) <b>M332</b> <sup>*1</sup>	<b>Current output gain signal</b>	100%	0 to 100%	Sets the signal value when the analog current output is at maximum.
<b>C11</b> (931) <b>M333</b> <sup>*1</sup>	<b>Current output gain current</b>	100%	0 to 100%	Set the current value at the maximum analog current output.
<b>867</b> <b>M321</b>	<b>AM output filter</b>	0.01 s	0 to 5 s	Set a filter for output via terminal AM.
<b>869</b> <b>M334</b>	<b>Current output filter</b>	0.01 s	0 to 5 s	Set a filter for output via terminal CA.

\*1 The parameter number in parentheses is that used (displayed) on the LCD operation panel and the parameter unit.

### ◆ Terminal FM calibration (C0 (Pr.900))

- The output via terminal FM is set to the pulse output. By setting **C0 (Pr.900)**, the meter connected to the inverter can be calibrated by parameter setting without use of a calibration resistor.

- The pulse train output via terminal FM can be used for digital display on a digital counter. The output is 1440 pulses/s at full scale. (Refer to [page 457](#) for the full-scale value of each monitor item.)

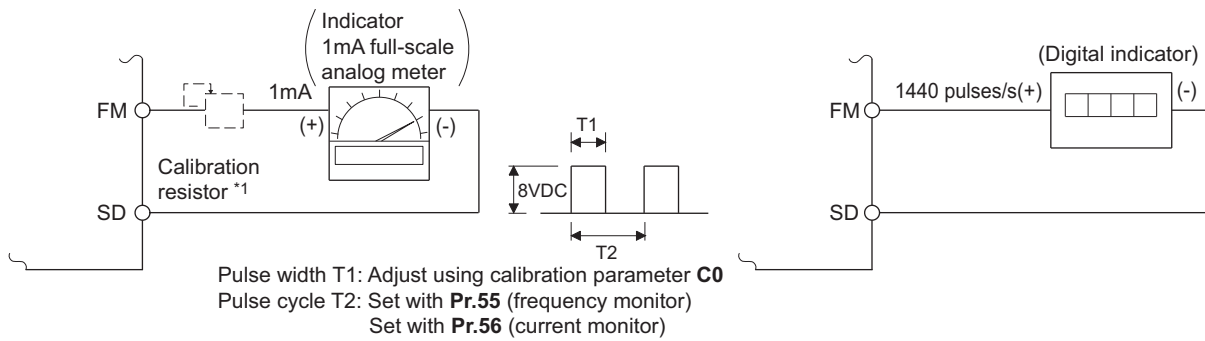

- \*1 Not needed when the operation panel or the parameter unit is used for calibration. Use a calibration resistor when the indicator (frequency meter) needs to be calibrated by a neighboring device because the indicator is located far from the inverter. However, the frequency meter needle may not deflect to full-scale if the calibration resistor is connected. In this case, perform calibration using the operation panel or parameter unit.
- \*2 In the initial setting, 1 mA full-scale and 1440 pulses/s terminal FM are used at 60 Hz.

- Calibrate the output via terminal FM in the following procedure.















1. Connect an indicator (frequency meter) across terminals FM and SD on the inverter. (Note the polarity. Terminal FM is positive.)
2. When a calibration resistor has already been connected, adjust the resistance to "0" or remove the resistor.
3. Set a monitor item in **Pr.54 AM terminal function selection**. (Refer to [page 457](#).)  
When the output frequency or inverter output current is selected on the monitor, set the output frequency or current value at which the output signal will be 1440 pulses/s, using **Pr.55 Frequency monitoring reference** or **Pr.56 Current monitoring reference** beforehand. Normally, at 1440 pulses/s the meter deflects to full-scale.
4. If the meter needle does not point to maximum even at maximum output, calibrate it with **C0 (Pr.900)**.

**NOTE**

- When outputting an item such as the output current, which cannot reach a 100% value easily by operation, set **Pr.54** to "21" (reference voltage output) and calibrate. A pulse train of 1440 pulses/s are output via terminal FM.
- When **Pr.310 Analog meter voltage output selection** = "21", the output via terminal AM cannot be calibrated. For details on **Pr.310**, refer to the Instruction Manual of the FR-A8AY.
- The wiring length to terminal FM should be 200 m at maximum.
- The initial value of the calibration parameter **C0 (Pr.900)** is set to 1 mA full-scale and 1440 pulses/s terminal FM pulse train output at 60 Hz. The maximum pulse train output of terminal FM is 2400 pulses/s.
- When connecting a frequency meter between terminals FM-SD and monitoring the output frequency, it is necessary to change **Pr.55** to the maximum frequency, since the FM terminal output will be saturated at the initial value when the maximum frequency reaches 100 Hz or greater.
- Calibration with the calibration parameter **C0 (Pr.900)** cannot be done when **Pr.291 Pulse train I/O selection** = "10, 11, 20, 21, or 100" (high-speed pulse train output).

## ◆ Calibration procedure for terminal FM when using the operation panel (FR-DU08)

### Operating procedure

1. Turning ON the power of the inverter  
The operation panel is in the monitor mode.
2. Changing the operation mode  
Press  to choose the PU operation mode. [PU] indicator turns ON.  
Calibration is also possible in the External operation mode.
3. Selecting the parameter setting mode  
Press  to choose the parameter setting mode. (The parameter number read previously appears.)
4. Calibration parameter selection  
Turn  until "C. . . ." appears. Press  to display "C - - - -".
5. Selecting a parameter  
Turn  until "C  (C0 (Pr.900) FM/CA terminal calibration) appears. Press  to enable the parameter setting.  
The monitored value of the item (initially the output frequency) selected by **Pr.54 FM/CA terminal function selection** will appear.
6. Pulse output via terminal FM  
If stopped, press  or  to start the inverter operation. (To monitor the output frequency, motor connection is not required.)  
When a monitor that does not require inverter operation is set in **Pr.54**, calibration is also possible during a stop status.
7. Scale adjustment  
Turn  to move the meter needle to a desired position.
8. Setting completed  
Press  to confirm the selection. The monitored value and "C " blink alternately.
  - Turn  to read another parameter.
  - Press  to return to the "C - - - -" display.
  - Press  twice to show the next parameter.

### NOTE

- Calibration can also be made for External operation. Set the frequency in the External operation mode, and make calibration in the above procedure.
- Calibration can be performed during operation.
- For the operation from the parameter unit, refer to the Instruction Manual of the parameter unit.

## ◆ Terminal CA calibration (C0 (Pr.900), C8 (Pr.930) to C11 (Pr.931))

- Terminal CA is initially set to provide a 20 mADC output in the full-scale state of the corresponding monitor item. The calibration parameter **C0 (Pr.900)** allows the output current ratio (gains) to be adjusted according to the meter scale. Note that the maximum output current is 20 mADC.

- Set a value at the minimum current output in the calibration parameters **C8 (Pr.930)** and **C9 (Pr.930)**. The calibration parameters **C10 (Pr.931)** and **C11 (Pr.931)** are used to set a value at the maximum current output.
- Set the output signal values (output monitor set with **Pr.54**) at zero or at the maximum current output via terminal CA using the calibration parameters **C8 (Pr.930)** and **C10 (Pr.931)**. The full scale for each monitor is 100% at this time.
- Set the output current values (output monitor set with **Pr.54**) at zero and at the maximum current output via terminal CA (using the calibration parameters **C9 (Pr.930)** and **C11 (Pr.931)**). The output current calibrated by the calibration parameter **C0 (Pr.900)** is 100% at this time.

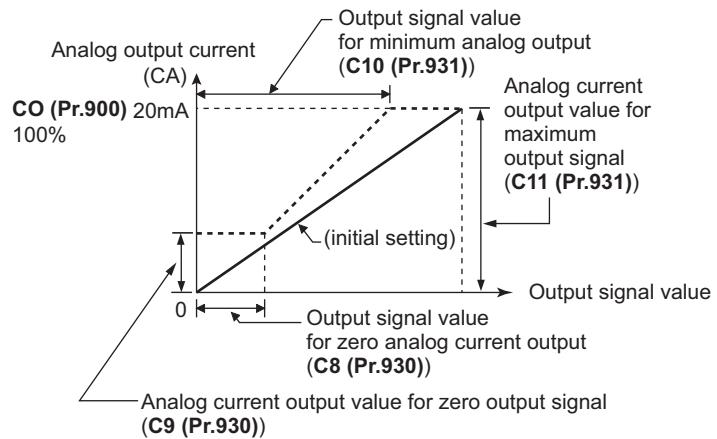
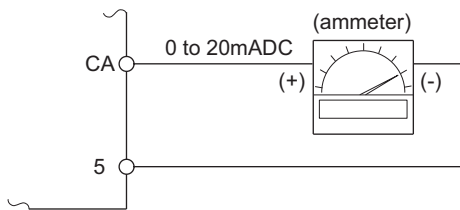

- Calibrate the output via terminal CA in the following procedure.
  - 1.** Connect a 0-20 mADC indicator (frequency meter) across terminals CA and 5 on the inverter. (Note the polarity. Terminal CA is positive.)
  - 2.** Set the initial value of the calibration parameter **C8 (Pr.930)** to **C11 (Pr.931)**. If the meter needle does not indicate zero when the current input is at zero, calibrate the meter using **C8 (Pr.930)** and **C9 (Pr.930)**.
  - 3.** Set a monitor item in **Pr.54 FM/CA terminal function selection**. (Refer to [page 457](#).)  
When the output frequency or inverter output current is selected on the monitor, set the output frequency or current value at which the output signal will be 20 mA, using **Pr.55** or **Pr.56** beforehand.
  - 4.** If the meter needle does not point to maximum even at maximum output, calibrate it with **C0 (Pr.900)**.

#### NOTE

- When outputting an item such as output current, which cannot reach a 100% value easily by operation, set **Pr.54** to "21" (reference voltage output) and calibrate. A current of 20 mADC is output via terminal CA.
- When **Pr.310 Analog meter voltage output selection** = "21", the output via terminal CA cannot be calibrated. For details on **Pr.310**, refer to the Instruction Manual of the FR-A8AY.
- The output via terminal CA is enabled even if **C8 (Pr.930) ≥ C10 (Pr.931)**, **C9 (Pr.930) ≥ C11 (Pr.931)**.

### ◆ Adjusting the response of terminal CA (Pr.869)

- Using **Pr.869**, the output voltage response of terminal CA can be adjusted in the range of 0 to 5 seconds.
- Increasing the setting stabilizes the output via terminal CA more but reduces the response level. (Setting "0" sets the response level to 7 ms.)

## ◆ Calibration of terminal AM (C1 (Pr.901))

- Terminal AM is initially set to provide a 10 VDC output in the full-scale state of the corresponding monitor item. The calibration parameter **C1 (Pr.901) AM terminal calibration** allows the output voltage ratio (gains) to be adjusted according to the meter scale. Note that the maximum output voltage is 10 VDC.

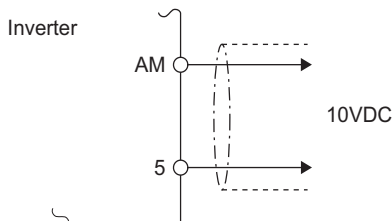

- Calibrate the output via terminal AM in the following procedure.
  1. Connect a 0-10 VDC indicator (frequency meter) across terminal AM and terminal 5 on the inverter. (Note the polarity. Terminal AM is positive.)
  2. Set a monitor item in **Pr.158 AM terminal function selection**. (Refer to [page 457](#).)  
When the output frequency or inverter output current is selected on the monitor, set the output frequency or current value at which the output signal is 10 V, using **Pr.55** or **Pr.56** beforehand.
  3. If the meter needle does not point to maximum even at maximum output, calibrate it with **C1 (Pr.901)**.

5

### NOTE

- When outputting an item such as the output current, which cannot reach a 100% value easily by operation, set **Pr.158** to "21" (reference voltage output) and calibrate. A voltage of 10 VDC is output via terminal AM.
- When **Pr.306 Analog output signal selection** = "21", the output via terminal AM cannot be calibrated. For details on **Pr.306**, refer to the Instruction Manual of the FR-A8AY.
- Use **Pr.290 Monitor negative output selection** to enable negative signals output via terminal AM. The output voltage range is -10 to +10 VDC. Calibrate the maximum positive value output via terminal AM.

## ◆ Adjusting the response of terminal AM (Pr.867)

- Use **Pr.867** to adjust the output voltage response of the terminal AM in the range of 0 to 5 seconds.
- Increasing the setting stabilizes the output via terminal AM more but reduces the response level. (Setting "0" means the setting of the response level to 7 ms.)

### Parameters referred to

- Pr.54 FM/CA terminal function selection** [page 457](#)
- Pr.55 Frequency monitoring reference** [page 457](#)
- Pr.56 Current monitoring reference** [page 457](#)
- Pr.158 AM terminal function selection** [page 457](#)
- Pr.290 Monitor negative output selection** [page 457](#)
- Pr.291 Pulse train I/O selection** [page 406](#)

## 5.11.5 Energy saving monitoring

From the power consumption estimated value during commercial power supply operation, the energy saving effect by use of the inverter can be monitored and output.



Pr.	Name	Initial value	Setting range	Description
52 M100	Operation panel main monitor selection	0 (output frequency)	Refer to page 446.	50: Energy saving effect monitoring, 51: Cumulative energy saving monitoring
774 M101	Operation panel monitor selection 1	9999		
775 M102	Operation panel monitor selection 2			
776 M103	Operation panel monitor selection 3			
992 M104	Operation panel setting dial push monitor selection	0 (set frequency)		
54 M300	FM/CA terminal function selection	1 (output frequency)	Refer to page 457.	50: Energy saving effect monitoring
158 M301	AM terminal function selection			
891 M023	Cumulative power monitor digit shifted times	9999	0 to 4	Set the number of times to move the digit of cumulative power monitored value. The readout peaks out at the upper limit of readout.
			9999	The function of moving the decimal point is not available. The readout is reset to 0 when it exceeds the upper limit.
892 M200	Load factor	100%	30 to 150%	Set the load factor for the commercial power supply operation. The setting is used for calculation of the estimated power consumption during commercial power supply operation by being multiplied by the power consumption rate (page 472).
893 M201	Energy saving monitor reference (motor capacity)	Inverter rated capacity	0.1 to 55 kW <sup>*1</sup>	Set the motor capacity (pump capacity). Setting this parameter is required for calculating the rate of saved power, the rate of average energy saving, and the commercial power.
			0 to 3600 kW <sup>*2</sup>	
894 M202	Control selection during commercial power-supply operation	0	0	Discharge damper control (fan)
			1	Inlet damper control (fan)
			2	Valve control (pump)
			3	Commercial power supply drive (fixed value)
895 M203	Power saving rate reference value	9999	0	Consider the commercial power as 100%.
			1	Consider the power set in Pr.893 as 100%
			9999	No function
896 M204	Power unit cost	9999	0 to 500	Set the power unit cost. Setting this parameter is required for displaying the energy cost savings in the energy saving monitoring.
			9999	No function
897 M205	Power saving monitor average time	9999	0	The time period for averaging is 30 minutes.
			1 to 1000 h	Set the number of hours for averaging.
			9999	No function
898 M206	Power saving cumulative monitor clear	9999	0	Clear the cumulative monitor value
			1	Hold the cumulative monitor value
			10	Continue accumulation (upper limit communication data is 9999)
			9999	Continue accumulation (upper limit communication data is 65535)
899 M207	Operation time rate (estimated value)	9999	0 to 100%	Setting this parameter is required for calculating the annual energy saving. Set an annual operating rate (considering a 24-hours-a-day and 365-days-a-year operation as 100%).
			9999	No function

\*1 For the FR-A820-03160(55K) or lower, and FR-A840-01800(55K) or lower.

\*2 For the FR-A820-03800(75K) or higher, and FR-A840-02160(75K) or higher.

## ◆ Energy saving monitoring list

- The items in the energy saving effect monitoring (items which can be monitored when "50" is set in **Pr.52, Pr.54, Pr.158, Pr.774 to Pr.776, and Pr.992**) are listed below.

(The items which can be monitored via terminal FM or CA (**Pr.54** setting) and via terminal AM (**Pr.158** setting) are limited to [1 Power saving] and [3 Average power saving].)

	Energy saving monitor item	Description and formula	Unit and increment	Parameter setting			
				Pr.895	Pr.896	Pr.897	Pr.899
1	Power saving	The difference between the input power calculated by the inverter and the estimated power required to run a motor off a commercial power supply. [Input power for commercial power supply operation] - [Monitored value of inverter input power]	0.01/0.1 kW <sup>*3</sup>	9999			
2	Power saving rate	It is defined as the power saving expressed as a percentage. The rate of the power saving with respect to the estimated input power for the commercial power supply operation is determined using the following formula. $\frac{[1 \text{ Power saving}]}{\text{Power during commercial power supply operation}} \times 100$	0.1%	0	—	9999	
		The rate of the power saving with respect to the <b>Pr.893</b> setting is determined using the following formula. $\frac{[1 \text{ Power saving}]}{\text{Pr.893}} \times 100$		1			
3	Average power saving	It is defined as the average hourly energy saving during a monitoring time (set in <b>Pr.897</b> ). $\frac{\sum ([1 \text{ Power saving}] \times \Delta t)}{\text{Pr.897}}$	0.01/0.1 kWh <sup>*3</sup>	9999			—
4	Average power saving rate	It is defined as the average hourly energy saving expressed as a percentage. The rate of the average hourly energy saving with respect to the estimated input power for the commercial power supply operation is determined using the following formula. $\frac{\sum ([2 \text{ Power saving rate}] \times \Delta t)}{\text{Pr.897}} \times 100$	0.1%	0	9999		0 to 1000 h
		The rate of the average hourly energy saving with respect to the <b>Pr.893</b> setting is determined using the following formula. $\frac{[3 \text{ Average power saving}]}{\text{Pr.893}} \times 100$		1			
5	Average power cost savings	It is defined as a monetary value of the average hourly energy saving, determined using the following formula. <b>[3 Average power saving] × Pr.896 setting</b>	0.01/0.1 <sup>*3</sup>	—	0 to 500		

- The items in the cumulative energy saving monitoring (items which can be monitored when "51" is set in **Pr.52**, **Pr.774 to Pr.776**, and **Pr.992**) are listed below.

(The digit of the cumulative energy saving monitored value can be moved to the right according to the setting of **Pr.891 Cumulative power monitor digit shifted times**.)

	Energy saving monitor item	Description and formula	Unit and increment	Parameter setting			
				Pr.895	Pr.896	Pr.897	Pr.899
6	Power saving amount	It is defined as a cumulative energy saving during monitoring, determined by multiplying the saved power by the number of inverter operating hours. $\Sigma ([1 \text{ Power saving}] \times \Delta t)$	0.01 kWh/ 0.1 kWh <sup>*1*2*3</sup>	—	9999	—	9999
7	Power cost savings	It is defined as a monetary value of the cumulative energy saving. <b>[6 Power saving amount] × Pr.896 setting</b>	0.01/ 0.1 <sup>*1*3</sup>	—	0 to 500		
8	Annual power saving amount	It is defined as an estimated annual energy saving. $\frac{[6 \text{ Power saving amount}]}{\text{Operation time during power saving accumulation}} \times 24 \times 365 \times \frac{\text{Pr.899}}{100}$	0.01 kWh/ 0.1 kWh <sup>*1*2*3</sup>	—	9999	—	0 to 100%
9	Annual power cost savings	It is defined as a monetary value of annual energy saving. <b>[8 Annual power saving amount] × Pr.896 setting</b>	0.01/ 0.1 <sup>*1*3</sup>	—	0 to 500		

\*1 For monitoring via communication (RS-485 communication, or other communication using a communication option), the increments are 1 in no units. For example, a value "10.00 kWh" is converted into "10" for communication data.

\*2 On the LCD operation panel or the parameter unit, a readout is displayed in units of kilowatt-hours (kW).

\*3 The increment differs according to the inverter capacity. (Increment left of a slash for FR-A820-03160(55K) or lower, FR-A840-01800(55K) or lower. Increment right of a slash for FR-A820-03800(75K) or higher, FR-A840-02160(75K) or higher.)

## NOTE

- The operation panel and the parameter unit have a 5-digit display. This means, for example, that a monitored value up to 999.99 is displayed in 0.01 increments and a monitor value of 1000 or more is displayed in 0.1 increments as "1000.0". The maximum monitored value displayed is "99999".
- The maximum monitored value via communication (RS-485 communication or other communication with communication option installed) is 65535 when **Pr.898 Power saving cumulative monitor clear** = "9999". The maximum monitored value on monitoring in 0.01 increments is "655.35", and that on monitoring in 0.1 increments is "6553.5".

## ◆ Power saving real-time monitoring ([1 Power saving], [2 Power saving rate])

- During **[1 Power saving]** monitoring, an energy saving effect (power difference) of using the inverter as compared to the commercial power supply operation is calculated and displayed on the main monitor.
- In the following cases, the monitored value of **[1 Power saving]** is "0".  
The result of calculating the saved power is negative value.  
DC injection brake works.  
The motor is not connected with the inverter (monitored value of output current is 0 A).
- On **[2 Power saving rate]** monitoring, the rate of the saved power considering the consumed power (estimate) during the power supply operation as 100% is displayed when **Pr.895 Power saving rate reference value** is set to "0". When **Pr.895** is set to "1", the rate of the saved power with respect to the setting of **Pr.893 Energy saving monitor reference (motor capacity)** that is referenced as 100% is displayed.

## ◆ Average power saving monitoring ([3 Average power saving], [4 Average power saving rate], [5 Average power cost savings])

- The average power saving monitors are displayed by setting a value other than 9999 in **Pr.897 Power saving monitor average time**.
- On **[3 Average power saving]** monitoring, the average hourly energy saving every preset time period is displayed.

- When the setting of **Pr.897** is changed, when the inverter is powered ON, or when the inverter is reset, the averaging is restarted. The Energy saving average value updated timing (Y92) signal is inverted every time the averaging is restarted.

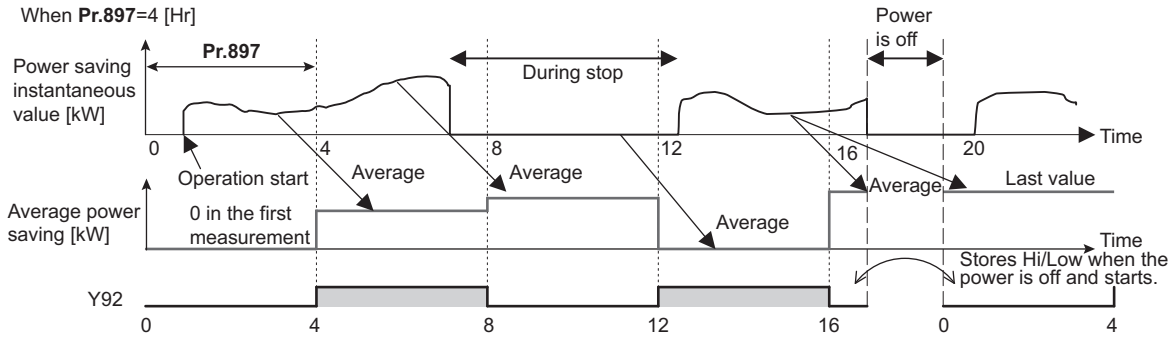

- On **[4 Average power saving rate]** monitoring, the average hourly monitored value of **[2 Power saving rate]** is displayed when **Pr.895 Power saving rate reference value** is set to "0 or 1".
- On **[5 Average power cost savings]** monitoring, a monetary value of the average hourly energy saving (**[3 Average power saving] × Pr.896 setting**) is displayed when the unit price, power cost per kilowatt (hour), is set in **Pr.896 Power unit cost**.

### ◆ Cumulative energy saving monitoring (**[6 Power saving amount]**, **[7 Power cost saving]**, **[8 Annual power saving amount]**, **[9 Annual power cost savings]**)

- The digit of the cumulative energy monitored value can be moved to the right by the number set in **Pr.891 Cumulative power monitor digit shifted times**. For example, when the cumulative energy is 1278.56 kWh and **Pr.891** is set to "2", "12.78" is displayed (in 100's of units) on the PU/DU and the communication data is converted into "12". When **Pr.891** = "0 to 4" and the cumulative energy reaches more than the upper limit of readout, the readout peaks out at the upper limit, which indicates that moving digit is necessary. When **Pr.891** = "9999" and the cumulative energy reaches more than the upper limit of readout, cumulative value is reset to 0 and the metering restarts. The readout of other items in the cumulative energy saving monitoring peaks out at the upper limit of readout.
- With the monitored value of **[6 Power saving amount]**, a cumulative energy saving during a desired time period can be measured. Follow this procedure.

- Set "10" or "9999" in **Pr.898 Power saving cumulative monitor clear**.
- Change the setting of **Pr.898** to "0" when you want to start measuring the energy saving. The cumulative value is cleared and the cumulative energy saving meter restarts.
- Change the setting of **Pr.898** to "1" when you want to stop measuring the energy saving. The meter stops and the cumulative value is fixed.

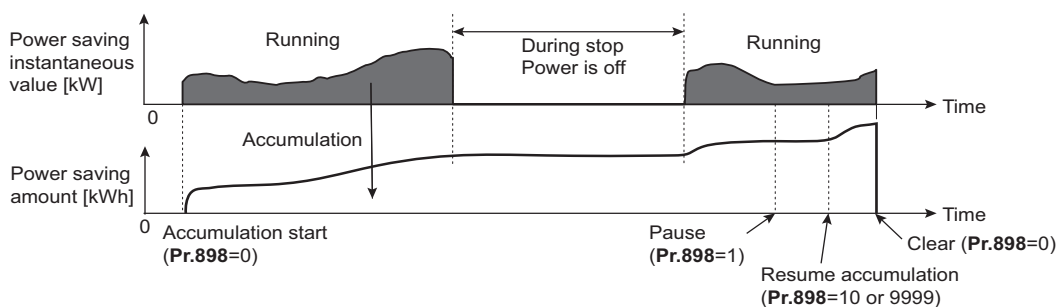

**NOTE**

- The cumulative value of energy saving is refreshed every hour. This means that the last cumulative value is displayed at a restart of the inverter and the cumulative meter restarts if the time elapsed between turning OFF and re-turning ON of the inverter is shorter than an hour. (In some cases, the cumulative energy value may decrease.)

## ◆ Estimated input power for the commercial power supply operation (Pr.892, Pr.893, Pr.894)

- Select the pattern of the commercial power supply operation from among four patterns (discharge damper control (fan), suction damper control (fan), valve control (pump) and commercial power drive), and set it in **Pr.894 Control selection during commercial power-supply operation**.
- Set the motor capacity (pump capacity) in **Pr.893 Energy saving monitor reference (motor capacity)**.
- Refer to the following graph to find the rate of power consumption (%) during commercial power supply operation based on the selected pattern and the rate of motor rotations per minute with respect to the rated speed (the result of dividing the present output frequency by **Pr.3 Base frequency** setting).

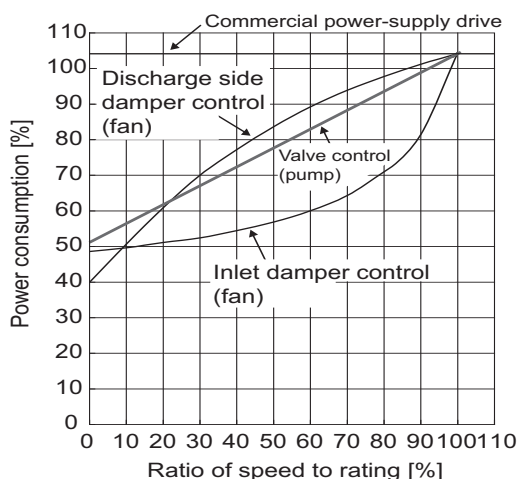

- The estimated input power (kW) for the commercial power supply operation is calculated from the motor capacity set in **Pr.893**, the setting of **Pr.892 Load factor**, and the rate of power consumption using the following formula.

$$\text{Estimated consumed power during commercial power supply operation (kW)} = \text{Pr.893 (kW)} \times \frac{\text{Consumed power (\%)}}{100} \times \frac{\text{Pr.892 (\%)}}{100}$$

### NOTE

- If the output frequency rises to the setting of **Pr.3 Base frequency** or higher, it stays at a constant value because the rotations per minute cannot rise higher than the power supply frequency during commercial power supply operation.

## ◆ Annual energy saving and its monetary value (Pr.899)

- When the operation time rate (ratio of the time period in year when the inverter drives the motor) [%] is set in **Pr.899**, the annual energy saving effect can be estimated.
- When the inverter is operated in specific patterns, the estimate annual energy saving can be calculated by measuring the energy saving in a certain period.
- Refer to the following procedure to set the operation time rate.

1. Estimate the average operation time per day (h/day).
2. Calculate the operation days per year (days/year) using the following formula: Average operation days per month × 12 (months).
3. Calculate the annual operation time (h/year) from values determined in Step 1 and Step 2, using the following formula.

$$\text{Annual operation time (h/year)} = \text{average time (h/day)} \times \text{number of operation days (days/year)}$$

4. Calculate the operation time rate using the following formula, and set it in **Pr.899**.

$$\text{Operation time rate (\%)} = \frac{\text{Annual operation time (h/year)}}{24 \text{ (h/day)} \times 365 \text{ (days/year)}} \times 100(\%)$$

**NOTE**

- Setting example for operation time rate: In the case where the average operation time per day is about 21 hours and the average operation days per month is 16 days.

$$\text{Annual operation time} = 21 \text{ (h/day)} \times 16 \text{ (days/month)} \times 12 \text{ (months)} = \underline{4032 \text{ (h/year)}}$$

$$\text{Operation time rate (\%)} = \frac{4032 \text{ (h/year)}}{24 \text{ (h/day)} \times 365 \text{ (days/year)}} \times 100(\%) = \underline{46.03\%}$$

Therefore, set 46.03% in **Pr.899**.

- Calculate the annual energy saving from the value of [3 Average power saving] cumulated according to the setting of **Pr.899 Operation time rate (estimated value)**.

$$\text{Annual power saving amount (kWh/year)} = \frac{\text{With Pr.898} = 10 \text{ or } 9999, \text{ average power saving (kW) during cumulative period}}{\text{Pr.899}} \times 24\text{h} \times 365 \text{ days} \times \frac{\text{Pr.899}}{100}$$

- When the power cost per hour is set in **Pr.896 Power unit cost**, the annual energy cost savings can be monitored. The annual energy cost savings is determined by calculation using the following formula.

$$\text{Annual power cost saving} = \text{annual power saving amount (kWh/year)} \times \text{Pr.896}$$

**NOTE**

- During regenerative driving, substitute the output power during the commercial power supply operation for the saved power (therefore, input power = 0).

**Parameters referred to**

Pr.3 Base frequency [page 707](#)

Pr.52 Operation panel main monitor selection [page 446](#)

Pr.54 FM/CA terminal function selection [page 457](#)

Pr.158 AM terminal function selection [page 457](#)

## 5.11.6 Output terminal function selection

Use the following parameters to change the functions of the open collector output terminals and relay output terminals.

Pr.	Name	Initial value	Signal name	Setting range
190 M400	RUN terminal function selection	0	RUN (Inverter running)	0 to 8, 10 to 20, 22, 25 to 28, 30 to 36, 38 to 57, 60, 61, 63, 64, 67, 68, 70, 79, 80, 84, 85, 90 to 99, 100 to 108, 110 to 116, 120, 122, 125 to 128, 130 to 136, 138 to 157, 160, 161, 163, 164, 167, 168, 170, 179, 180, 184, 185, 190 to 199, 200 to 208, 211 to 213, 247, 300 to 308, 311 to 313, 347, 9999
191 M401	SU terminal function selection	1	SU (Up to frequency)	
192 M402	IPF terminal function selection	2 <sup>*1</sup>	IPF (Instantaneous power failure/undervoltage)	
		9999 <sup>*2</sup>	No function	
193 M403	OL terminal function selection	3	OL (Overload warning)	
194 M404	FU terminal function selection	4	FU (Output frequency detection)	
195 M405	ABC1 terminal function selection	99	ALM (Fault)	0 to 8, 10 to 20, 22, 25 to 28, 30 to 36, 38 to 57, 60, 61, 63, 64, 67, 68, 70, 79, 80, 84, 85, 90, 91, 94 to 99, 100 to 108, 110 to 116, 120, 122, 125 to 128, 130 to 136, 138 to 157, 160, 161, 163, 164, 167, 168, 170, 179, 180, 184, 185, 190, 191, 194 to 199, 200 to 208, 211 to 213, 247, 300 to 308, 311 to 313, 347, 9999
196 M406	ABC2 terminal function selection	9999	No function	
313 M410 <sup>*3*4</sup>	DO0 output selection	9999	No function	0 to 8, 10 to 20, 22, 25 to 28, 30 to 36, 38 to 57, 60, 61, 63, 64, 68, 70, 79, 80, 84 to 99, 100 to 108, 110 to 116, 120, 122, 125 to 128, 130 to 136, 138 to 157, 160, 161, 163, 164, 168, 170, 179, 180, 184 to 199, 200 to 208, 211 to 213, 247, 248, 300 to 308, 311 to 313, 347, 348, 9999
314 M411 <sup>*3*4</sup>	DO1 output selection	9999	No function	
315 M412 <sup>*3*4</sup>	DO2 output selection	9999	No function	
316 M413 <sup>*3</sup>	DO3 output selection	9999	No function	
317 M414 <sup>*3</sup>	DO4 output selection	9999	No function	
318 M415 <sup>*3</sup>	DO5 output selection	9999	No function	
319 M416 <sup>*3</sup>	DO6 output selection	9999	No function	
320 M420 <sup>*3</sup>	RA1 output selection	0	RUN (Inverter running)	0 to 8, 10 to 20, 22, 25 to 28, 30 to 36, 38 to 57, 60, 61, 63, 64, 68, 70, 79, 80, 84 to 91, 94 to 99, 200 to 208, 211 to 213, 247, 248, 9999
321 M421 <sup>*3</sup>	RA2 output selection	1	SU (Up to frequency)	
322 M422 <sup>*3</sup>	RA3 output selection	2 <sup>*1</sup>	IPF (Instantaneous power failure/undervoltage)	
		9999 <sup>*2</sup>	No function	

Pr.	Name	Initial value	Setting range	Description
289 M431	Inverter output terminal filter	9999	5 to 50 ms	Set the time delay for the output terminal response.
			9999	No filtering of the output terminal.

\*1 The initial value is for standard models and IP55 compatible models.

\*2 The initial value is for separated converter types.

\*3 The setting is available when the PLC function is enabled or when a compatible plug-in option is installed.

\*4 The setting is available for the FR-A800-GF.

## ◆ Output signal list

- A function listed below can be set to each output terminal.
- Refer to the following table and set the parameters. (0 to 99, 200 to 299: Positive logic, 100 to 199, 300 to 399: Negative logic)

Setting		Signal name	Function	Operation	Related parameter	Refer to page
Positive logic	Negative logic					
0	100	RUN	Inverter running	Outputted during operation when the inverter output frequency reaches <b>Pr.13 Starting frequency</b> or higher.	—	479



Setting		Signal name	Function	Operation	Related parameter	Refer to page
Positive logic	Negative logic					
1	101	SU	Up to frequency <sup>*1</sup>	Outputted when the output frequency reaches the set frequency.	Pr.41	484
2	102	IPF	Instantaneous power failure/undervoltage <sup>*5</sup>	Outputted when an instantaneous power failure or undervoltage protection operation occurs.	Pr.57	628, 635
3	103	OL	Overload warning	Outputted while the stall prevention function works.	Pr.22, Pr.23, Pr.66, Pr.148, Pr.149, Pr.154	431
4	104	FU	Output frequency detection	Outputted when the output frequency reaches the frequency set in Pr.42 (Pr.43 during reverse rotation) or higher.	Pr.42, Pr.43	484
5	105	FU2	Second output frequency detection	Outputted when the output frequency reaches the frequency set in Pr.50 or higher.	Pr.50	484
6	106	FU3	Third output frequency detection	Outputted when the output frequency reaches the frequency set in Pr.116 or higher.	Pr.116	484
7	107	RBP	Regenerative brake prealarm <sup>*2</sup>	Outputted when the regenerative brake duty reaches 85% of the setting of Pr.70.	Pr.70	724
8	108	THP	Electronic thermal O/L relay pre-alarm	Outputted when the cumulative electronic thermal O/L relay value reaches 85% of the trip level. (The electronic thermal O/L relay function (E.THT/E.THM) is activated when the value reaches 100%.)	Pr.9	415
10	110	PU	PU operation mode	Outputted when the PU operation mode is selected.	Pr.79	389
11	111	RY	Inverter operation ready	Outputted when the reset process is completed after powering ON the inverter or when the inverter is ready to start operation with the start signal ON or during operation.	—	479
12	112	Y12	Output current detection	Outputted when the output current is higher than the Pr.150 setting for the time set in Pr.151 or longer.	Pr.150, Pr.151	487
13	113	Y13	Zero current detection	Outputted when the output current is lower than the Pr.152 setting for the time set in Pr.153 or longer.	Pr.152, Pr.153	487
14	114	FDN	PID lower limit	Outputted when the input value is lower than the lower limit set for the PID control operation.	Pr.127 to Pr.134, Pr.575 to Pr.577	601
15	115	FUP	PID upper limit	Outputted when the input value is higher than the upper limit set for the PID control operation.		
16	116	RL	PID forward/reverse rotation output	Outputted during forward rotation operation in the PID control operation.		
17	—	MC1	Electronic bypass MC1	Used to work the electronic bypass function.	Pr.135 to Pr.139, Pr.159	563
18	—	MC2	Electronic bypass MC2			
19	—	MC3	Electronic bypass MC3			
20	120	BOF	Brake opening request	Outputted to release the brake while the brake sequence function is enabled.	Pr.278 to Pr.285, Pr.292	572
22	122	BOF2	Second brake opening request	Outputted to release the brake while the second brake sequence function is enabled (while the RT signal is ON).	Pr.641 to Pr.648	
25	125	FAN	Fan fault output	Outputted when a fan fault occurs.	Pr.244	423
26	126	FIN	Heat sink overheat pre-alarm	Outputted when the heat sink temperature rises to 85% of temperature at which the protective function of the Heat sink overheat is activated.	—	788
27	127	ORA	Orientation complete (output for a Vector control compatible option) <sup>*4</sup>	Outputted while the orientation control operation is enabled.	Pr.350 to Pr.366, Pr.369, Pr.393, Pr.396 to Pr.399	585
28	128	ORM	Orientation fault (output for a Vector control compatible option) <sup>*4</sup>			



Setting		Signal name	Function	Operation	Related parameter	Refer to page
Positive logic	Negative logic					
30	130	Y30	Forward rotation output (output for a Vector control compatible option) <sup>*4</sup>	Outputted while a motor rotates in forward direction.	—	482
31	131	Y31	Reverse rotation output (output for a Vector control compatible option) <sup>*4</sup>	Outputted while a motor rotates in reverse direction.	—	482
32	132	Y32	Regenerative status output (output for a Vector control compatible option) <sup>*4</sup>	Outputted while the motor is in a regenerative braking state under Vector control.	—	482
33	133	RY2	Operation ready 2	Outputted while pre-excitation is enabled or during normal operation under Real sensorless vector control, Vector control, or PM sensorless vector control.	—	479
34	134	LS	Low speed detection	Outputted when the output frequency drops to the <b>Pr.865</b> setting or lower.	<b>Pr.865</b>	484
35	135	TU	Torque detection	Outputted when the motor torque is higher than the <b>Pr.864</b> setting.	<b>Pr.864</b>	488
36	136	Y36	In-position	Outputted when the number of droop pulses drops below the setting.	<b>Pr.426</b>	327
38	138	MEND	Travel completed	Outputted when the droop pulse is within the in-position width and the position command operation is completed.	<b>Pr.426</b>	327
39	139	Y39	Start time tuning completion	Outputted when tuning at start-up is completed.	<b>Pr.95, Pr.574</b>	558
40	140	Y40	Trace status	Outputted during trace operation.	<b>Pr.1020 to Pr.1047</b>	649
41	141	FB	Speed detection	Outputted when the actual motor rotations per minute (estimate) reaches the setting of <b>Pr.42, Pr.50, or Pr.116</b> .	<b>Pr.42 to Pr.50, Pr.116</b>	484
42	142	FB2	Second speed detection			
43	143	FB3	Third speed detection			
44	144	RUN2	Inverter running 2	Outputted while the Forward rotation command signal or Reverse rotation command signal is ON. Outputted during deceleration even while the Forward rotation command signal or Reverse rotation command signal is OFF (except while pre-excitation is enabled (the LX signal is ON)). Also outputted while the Orientation command (X22) signal is ON. Outputted while the servo-lock function is working (the LX signal is ON) in the position control mode. (The signal output stops when the servo-lock function stops (the LX signal is OFF).)	—	479
45	145	RUN3	Inverter running and start command ON	Outputted while the inverter is running or while the start command signal is ON.	—	479
46	146	Y46	During deceleration at occurrence of power failure	Outputted when the power-failure deceleration function is activated. (The signal output is retained until the function stops.)	<b>Pr.261 to Pr.266</b>	642
47	147	PID	During PID control activated	Outputted during the PID control operation.	<b>Pr.127 to Pr.134, Pr.575 to Pr.577</b>	601
48	148	Y48	PID deviation limit	Outputted when the absolute deviation value exceeds the limit value.	<b>Pr.127 to Pr.134, Pr.553, Pr.554</b>	601
49	149	Y49	During pre-charge operation	Outputted while the pre-charge function is working.	<b>Pr.127 to Pr.134, Pr.241, Pr.553, Pr.554, Pr.575 to Pr.577, Pr.753 to Pr.769, C42, C45</b>	618
50	150	Y50	During second pre-charge operation			
51	151	Y51	Pre-charge time over			
52	152	Y52	Second pre-charge time over			
53	153	Y53	Pre-charge level over	Outputted when the value higher than the detection level set in <b>Pr.763</b> or <b>Pr.768</b> is measured until the pre-charge function stops during pre-charge operation.		
54	154	Y54	Second pre-charge level over			

Setting		Signal name	Function	Operation	Related parameter	Refer to page
Positive logic	Negative logic					
55	155	Y55	Motor temperature detection (for FR-A8AZ) <sup>*4</sup>	Outputted when the temperature of the thermistor-equipped vector control motor (SF-V5RU[JT/A]) exceeds the detection level.	Pr.750	—
56	156	ZA	Home position return failure	Outputted while the Home position return failure warning is output.	—	303
57	157	IPM	During PM sensorless vector control	Outputted while the operation is performed under PM sensorless vector control.	Pr.71 to Pr.80, Pr.998	230
60	160	FP	Position detection level	Outputted when the current position exceeds the position detection judgment value (set in Pr.1294 and Pr.1295).	Pr.1294 to Pr.1297	327
61	161	PBSY	During position command operation	Outputted during the position command operation.	—	303
63	163	ZP	Home position return completed	Outputted when the home position return operation is completed.	—	303
64	164	Y64	During retry	Outputted during retry operation.	Pr.65 to Pr.69	426
67	167	Y67	Power failed <sup>*3</sup>	Outputted when the inverter power output is shut off due to power failure or undervoltage or when the power failure time deceleration-to-stop function is activated.	Pr.261 to Pr.266	642
68	168	EV	24 V external power supply operation	Outputted while the inverter operated with a 24 V power supplied from an external source.	—	80
70	170	SLEEP	PID output interruption	Outputted while PID output suspension function is activated.	Pr.127 to Pr.134, Pr.575 to Pr.577	601
79	179	Y79	Pulse train output of output power	Outputted in pulses every time the cumulative value of energy outputted from the inverter reaches the Pr.799 setting.	Pr.799	493
80	180	SAFE	Safety monitor output	Outputted while the safety stop function is activated.	—	82
84	184	RDY	Position control preparation ready	Outputted when the servo-lock function is working (the LX signal turns ON) and the inverter is ready to operate.	Pr.419, Pr.428 to Pr.430	319
85	185	Y85	DC current feeding <sup>*5</sup>	Outputted during power failure or undervoltage of the AC power supply.	Pr.30	724
86	186	Y86	Control circuit capacitor life (for Pr.313 to Pr.322) <sup>*6</sup>	Outputted when the control circuit capacitor approaches the end of its life.	Pr.255 to Pr.259	359
87	187	Y87	Main circuit capacitor life (for Pr.313 to Pr.322) <sup>*5*6</sup>	Outputted when the main circuit capacitor approaches the end of its life.		
88	188	Y88	Cooling fan life (for Pr.313 to Pr.322) <sup>*6</sup>	Outputted when the cooling fan approaches the end of its life.		
89	189	Y89	Inrush current limit circuit life (for Pr.313 to Pr.322) <sup>*5*6</sup>	Outputted when the inrush current limit circuit approaches the end of its life.		
90	190	Y90	Life alarm	Outputted when any of the control circuit capacitor, main circuit capacitor, inrush current limit circuit, or the cooling fan approaches the end of its life.		
91	191	Y91	Fault output 3 (Power-OFF signal)	Outputted when the Fault occurs due to an inverter circuit fault or connection fault.	—	483
92	192	Y92	Energy saving average value updated timing	Switches between ON and OFF every time the average energy saving is updated during the energy saving monitoring. This signal cannot be assigned to any of the relay output terminal (Pr.195, Pr.196, Pr.320 to Pr.322).	Pr.52, Pr.54, Pr.158, Pr.891 to Pr.899	467
93	193	Y93	Current average monitor	Outputted in pulses for transmission of the average current value and the maintenance timer value. This signal cannot be assigned to any of the relay output terminal (Pr.195, Pr.196, Pr.320 to Pr.322).	Pr.555 to Pr.557	363
94	194	ALM2	Fault output 2	Outputted when the inverter's protective function is activated to stop the power output (when the Fault occurs). The signal output continues during the inverter reset and stops after the inverter reset finishes. <sup>*7</sup>	—	483

Setting		Signal name	Function	Operation	Related parameter	Refer to page
Positive logic	Negative logic					
95	195	Y95	Maintenance timer	Outputted when the value of <b>Pr.503</b> reaches the <b>Pr.504</b> setting or higher.	<b>Pr.503, Pr.504</b>	363
96	196	REM	Remote output	Outputted via a terminal by setting a proper number in a relative parameter.	<b>Pr.495 to Pr.497</b>	489
97	197	ER	Alarm output 2	The ER signal output follows the ALM signal output when <b>Pr.875</b> = "0 (initial value)". When <b>Pr.875</b> = "1" and when any of E.OHT, E.THM, or E.PTC occurs, the inverter decelerates the motor to a stop at a time of the ER signal ON. When any of other faults occurs, the ER signal outputs when the inverter output stops.	<b>Pr.875</b>	422
98	198	LF	Alarm	Outputted when an Alarm fault (fan fault or a communication error) occurs.	<b>Pr.121, Pr.244</b>	423, 663
99	199	ALM	Fault	Outputted when the inverter's protective function is activated to stop the power output (when the Fault occurs). The signal output stops when the inverter reset starts.	—	483
200	300	FDN2	Second PID lower limit	Outputted when the input value is lower than the lower limit set for the second PID control operation.	<b>Pr.753 to Pr.758</b>	601
201	301	FUP2	Second PID upper limit	Outputted when the input value is higher than the upper limit set for the second PID control operation.		
202	302	RL2	Second PID forward/reverse rotation output	Outputted during forward rotation operation in the second PID control operation.		
203	303	PID2	During second PID control activated	Outputted during the second PID control operation.		
204	304	SLEEP2	During second PID output shutoff	Outputted while the second PID output suspension function is activated.	<b>Pr.753 to Pr.758, Pr.1147 to Pr.1149</b>	
205	305	Y205	Second PID deviation limit	Outputted when the absolute deviation value exceeds the limit value during the second PID control operation.	<b>Pr.753 to Pr.758, Pr.1145, Pr.1146</b>	
206	306	Y206	Cooling fan operation command	Outputted when the cooling fan operation is commanded.	<b>Pr.244</b>	423
207	307	Y207	Control circuit temperature	Outputted when the temperature of the control circuit board reaches the detection level or higher.	<b>Pr.663</b>	494
208	308	PS	PU stopped	Outputted while the PU is stopped.	<b>Pr.75</b>	336
211	311	LUP	Upper limit warning detection	Outputted when the load fault upper limit warning is detected.	<b>Pr.1480 to Pr.1492</b>	439
212	312	LDN	Lower limit warning detection	Outputted when the load fault lower limit warning is detected.		
213	313	Y213	During load characteristics measurement	Outputted during measurement of the load characteristics.		
247	347	LSYN	Phase synchronization completion	Output when phase synchronization for bypass switching has completed (for FR-A8AVP). <sup>*4</sup>	<b>Pr.139</b>	—
248	348	Y248	Estimated residual-life of main circuit capacitor (for <b>Pr.313 to Pr.322</b> ) <sup>*5*6</sup>	Output when the main circuit capacitor approaches the end of its estimated life.	<b>Pr.255, Pr.506</b>	359
9999		—	No function	—	—	—

\*1 Note that changing the frequency setting with an analog signal or the setting dial on the operation panel (FR-DU08) may cause the turning ON and OFF of Up to frequency (SU) signal depending on its changing speed and the timing of the speed change determined by the acceleration/ deceleration time setting. (The signal state changing does not occur when the acceleration/deceleration time is set to 0 seconds.)

\*2 This signal is available only for the standard model.

\*3 This signal cannot be assigned to any of the output terminals for plug-in options (FR-A8AY and FR-A8AR).

\*4 This signal is available when the compatible plug-in option or control terminal option is installed.

\*5 The setting is available for the standard structure model and the IP55 compatible model.

\*6 This signal is available for the FR-A800-GF, when the PLC function is enabled, or when an option (FR-A8AY, FR-A8AR, FR-A8NC, or FR-A8NCE) is installed. Use **Pr.313 to Pr.322** to assign the function to the terminal. For the information of the availability of these parameters for each option, refer to the Instruction Manual of the option.

\*7 On restarting the inverter, the Fault output 2 (ALM2) signal turns OFF at the time the inverter power turns OFF.

## NOTE

- One function can be assigned to more than one terminal.
- The function works during the terminal conducts when the parameter setting is any of "0 to 99, 200 to 299", and the function works during the terminal does not conduct when the setting is "100 to 199, 300 to 399".
- When **Pr.76 Fault code output selection** = "1", the outputs of terminals SU, IPF, OL, and FU are used only for outputting the fault code according to the **Pr.76** setting. (When the inverter's protective function is activated, the signal for the fault code is output.)
- The output of terminal RUN and the outputs of the relay output terminals are not affected by the **Pr.76** setting.
- Changing the terminal assignment using **Pr.190 to Pr.196 (Output terminal function selection)** may affect the other functions. Set parameters after confirming the function of each terminal.
- Do not assign the signal to terminals A1, B1, and C1 or terminals A2, B2, and C2 which frequently changes its state between ON and OFF. Otherwise, the life of the relay contact may be shortened.

## ◆ Adjusting the output terminal response level (Pr.289)

- The responsivity of the output terminals can be delayed in a range between 5 to 50 ms. (The following is the operation example of the RUN signal.)

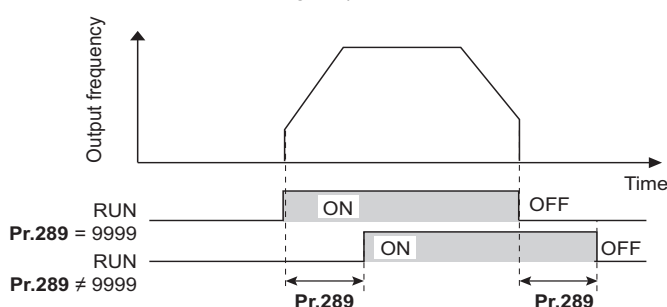

## NOTE

- When **Pr.157 OL signal output timer** is set for the Overload warning (OL) signal output, the OL signal is output when the set time of (**Pr.157 + Pr.289**) elapses.
- The signal output for the PLC function (see [page 646](#)) and for the fault code output (see [page 492](#)) are not affected by the **Pr.289** setting (not filtered for responsivity).

## ◆ Inverter operation ready signals (RY, RY2 signals) and inverter running signals (RUN, RUN2, RUN3 signals)

### ■ Operation under V/F control and Advanced magnetic flux vector control

- When the inverter is ready for operation, the Inverter operation ready (RY) signal turns ON (and stays ON during operation).
- When the inverter output frequency reaches the setting of **Pr.13 Starting frequency** or higher, the inverter running signals (RUN, RUN2 signals) turn ON. The signals are OFF while the inverter is stopped or during the DC injection brake operation.

- The Inverter running and start command ON (RUN3) signal is ON while the inverter is running or while the start command signal is ON (When the start command signal is ON, the RUN3 signal is ON even while the inverter's protective function is activated or while the MRS signal is ON.) The RUN3 signal is ON even during the DC injection brake operation, and the signal is OFF when the inverter stops.

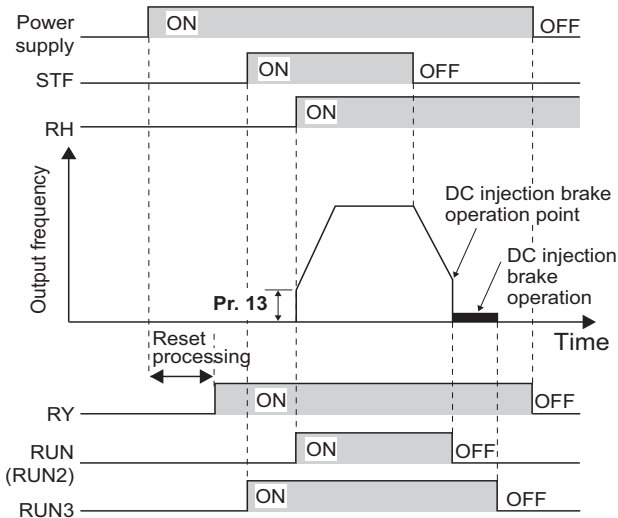

- The ON/OFF state of each signal according to the inverter operating status is shown in the matrix below.

Output signal	Start signal OFF (inverter stopped)	Start signal ON (inverter stopped)	Start signal ON (inverter running)	During DC injection brake operation	Inverter output shutoff <sup>*2</sup>		Automatic restart after instantaneous power failure		
					Start signal ON	Start signal OFF	During coasting		Inverter running after restart
							Start signal ON	Start signal OFF	
RY <sup>*3</sup>	ON	ON	ON	ON	OFF		ON <sup>*1</sup>		ON
RY2	OFF	OFF	OFF	OFF	OFF		OFF		OFF
RUN	OFF	OFF	ON	OFF	OFF		OFF		ON
RUN2	OFF	OFF	ON	OFF	OFF		OFF		ON
RUN3	OFF	ON	ON	ON	ON	OFF	ON	OFF	ON

\*1 The signal is OFF during power failure or undervoltage.

\*2 This means the state during a fault occurrence or while the MRS signal is ON, etc.

\*3 The signal is OFF while power is not supplied to the main circuit.

## ■ Operation under Real sensorless vector control, Vector control, and PM sensorless vector control

- When the inverter is ready for operation, the Inverter operation ready (RY) signal turns ON (and stays ON during operation).
- When the inverter output frequency reaches the setting of **Pr.13 Starting frequency** or higher, the Inverter running (RUN) turns ON. The signal is OFF during an inverter stop, during the DC injection brake operation, during tuning at start-up, or during pre-excitation.
- The Inverter running 2 (RUN2) signal is ON while the inverter is running or while the start command signal is ON. (When the inverter's protective function is activated or the MRS signal is ON, the RUN2 signal turns OFF.)
- The Inverter running and start command ON (RUN3) signal is ON while the inverter is running or while the start command signal is ON.
- The RUN2 and RUN3 signals are also ON when the start command signal is ON or during pre-excitation with the speed command value 0. (However, the RUN2 signal is OFF during pre-excitation with the LX signal ON.)

- The Operation ready 2 (RY2) signal turns ON when the pre-excitation starts. The signal is ON during pre-excitation even while the inverter stops its output. The signal is OFF during the inverter output shutoff.

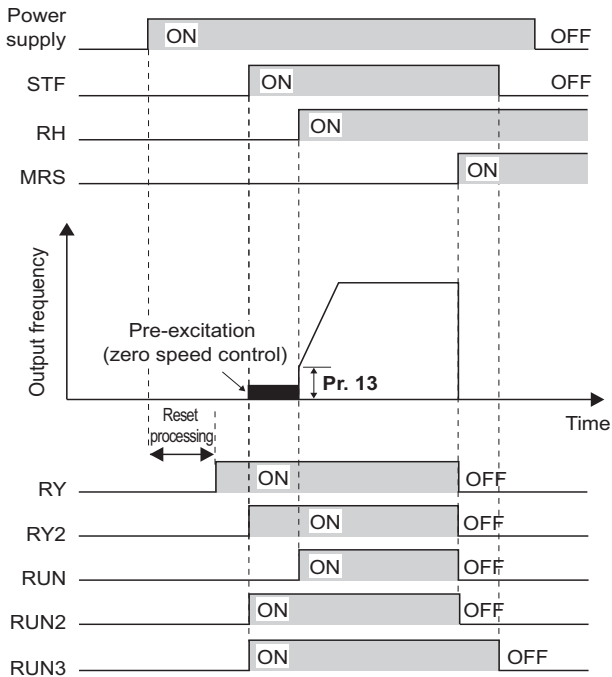

**NOTE**

- When pre-excitation works with the Pre-excitation/servo ON (LX) signal ON, the RY2 signal turns ON after 100 ms (500 ms for FR-A820-03800(75K) or higher, FR-A840-02160(75K) or higher) from the time the LX signal turns ON. (When online auto tuning at start-up is selected (Pr.95 = "1"), the time the signal turns ON is delayed by the tuning time.)

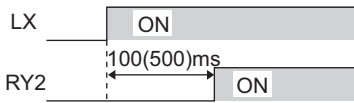

- The ON/OFF state of each signal according to the inverter operating status is shown in the matrix below.

Output signal	Start signal OFF (inverter stopped)	Start signal ON*1 (during pre-excitation)	Start signal ON (inverter running)	LX signal ON (during pre-excitation)	During DC injection brake operation (during pre-excitation)	Inverter output shutoff*5		Automatic restart after instantaneous power failure		
						Start signal ON	Start signal OFF	During coasting		Inverter running after restart
								Start signal ON	Start signal OFF	
RY*6	ON	ON	ON	ON	ON	OFF		ON*2		ON
RY2	OFF	ON	ON	ON*3	ON	OFF		OFF		ON
RUN	OFF	OFF	ON	OFF*4	OFF	OFF		OFF		ON
RUN2	OFF	ON	ON	OFF*4	OFF	OFF		OFF		ON
RUN3	OFF	ON	ON	ON	ON	ON	OFF	ON	OFF	ON

\*1 When the start signal is ON and the frequency command is 0 Hz, such state is designated as "during pre-excitation".  
 \*2 The signal is OFF during power failure or undervoltage.  
 \*3 The RY2 signal turns ON after 100 ms (500 ms for FR-A820-03800(75K) or higher, FR-A840-02160(75K) or higher) from the time the LX signal turns ON.  
 \*4 The signal is ON while the servo-lock function is ON (the LX signal is ON) in the position control mode.  
 \*5 This means the state during a fault occurrence or while the MRS signal is ON, etc.  
 \*6 The signal is OFF while power is not supplied to the main circuit.

- To use the RY, RY2, RUN, RUN2, or RUN3 signal, set the corresponding number selected from the following table in any of **Pr.190 to Pr.196 (Output terminal function selection)** to assign the function to an output terminal.

Output signal	Pr.190 to Pr.196 settings	
	Positive logic	Negative logic
RY	11	111
RY2	33	133
RUN	0	100
RUN2	44	144
RUN3	45	145

#### NOTE

- The RUN signal (positive logic) is initially assigned to the terminal RUN.

### ◆ Forward rotation output (Y30) signal and Reverse rotation output (Y31) signal

- Under Vector control, the Forward rotation output (Y30) signal or the Reverse rotation output (Y31) signal is output according to the actual rotation direction of the motor.
- During pre-excitation (zero-speed or servo-lock function ON) in the speed or torque control mode, the Y30 signal and the Y31 signal are OFF. During the servo-lock function ON in the position control mode, however, the Y30 signal or the Y31 signal is ON according to the actual rotation direction of the motor, as well as during normal operation.
- To use the Y30 signal, set "30 (positive logic) or 130 (negative logic)" in any of **Pr.190 to Pr.196 (Output terminal function selection)** to assign the function to the output terminal.
- To use the Y31 signal, set "31 (positive logic) or 131 (negative logic)" in any of **Pr.190 to Pr.196 (Output terminal function selection)** to assign the function to the output terminal.

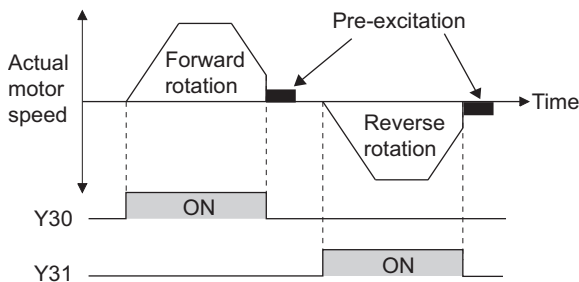

#### NOTE

- The Y30 and Y31 signals are always OFF under V/F control, Advanced magnetic flux vector control, Real sensorless vector control, and PM sensorless vector control.
- If the motor is rotated by an external force while the inverter is stopped, the Y30 signal and the Y31 signal keep OFF state.

### ◆ Regenerative status output (Y32) signal

- When the motor gets in a regenerative braking (dynamic braking) state under Vector control, the Regenerative status output (Y32) signal turns ON. Once the signal turns ON, the signal is retained ON for at least 100 ms.
- The signal is OFF during an inverter stop or during pre-excitation.

- To use the Y32 signal, set "32 (positive logic) or 132 (negative logic)" in any of **Pr.190 to Pr.196 (Output terminal function selection)** to assign the function to the output terminal.

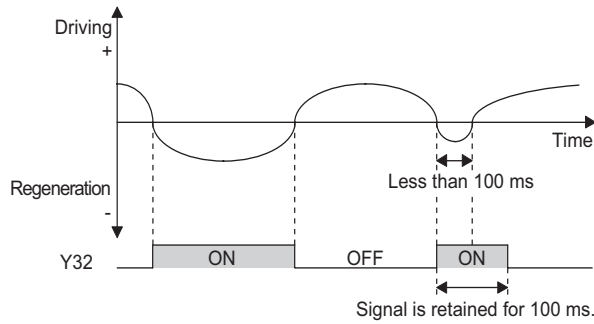

**NOTE**

- The Y32 signal is always OFF under V/F control, Advanced magnetic flux vector control, Real sensorless vector control, and PM sensorless vector control.

**◆ Fault (ALM) signal and Fault output 2 (ALM2) signal**

- The fault signal (ALM or ALM2 signal) is output when an inverter protective function is activated.
- The ALM2 signal stays ON during the resetting the inverter after the Fault occurs.
- To use the ALM2 signal, set "94 (positive logic) or 194 (negative logic)" in any of **Pr.190 to Pr.196 (Output terminal function selection)** to assign the function to an output terminal.
- The ALM signal is initially assigned to the relay terminals A1, B1, and C1.

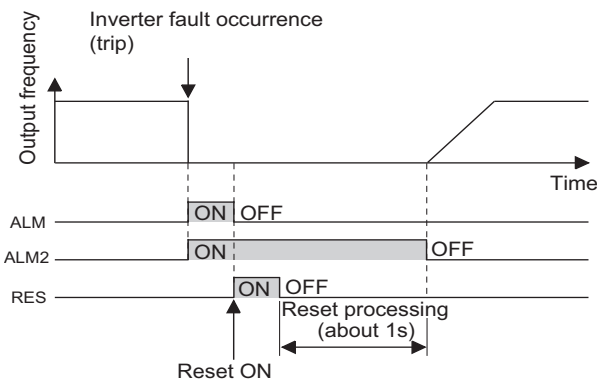

**NOTE**

- For details on the inverter faults, refer to [page 779](#).

**◆ Input power shutoff like magnetic contactor (Y91 signal)**

- The Fault output 3 (Y91) signal is output when a fault originating in the inverter circuit or a connection fault occurs.
- To use the Y91 signal, set "91 (positive logic) or 191 (negative logic)" in any of **Pr.190 to Pr.196 (Output terminal function selection)** to assign the function to an output terminal.



- The following is the list of faults that output the Y91 signal. (For details on faults, refer to [page 779](#).)

Fault type
Inrush current limit circuit fault (E.IOH)
CPU fault (E.CPU)
CPU fault (E.6)
CPU fault (E.7)
Parameter storage device fault (control circuit board) (E.PE)
Parameter storage device fault (main circuit board) (E.PE2)
24 VDC power fault (E.P24)
Operation panel power supply short circuit/RS-485 terminals power supply short circuit (E.CTE)
Output side earth (ground) fault overcurrent (E.GF)
Output phase loss (E.LF)
Brake transistor alarm detection (E.BE)
Internal circuit fault (E.13/E.PBT)

## ◆ Changing the special relay function for the PLC function

- For the PLC function, the function of special relays (SM1225 to SM1234) can be changed by setting **Pr.313 to Pr.322**. (For details on the PLC function, refer to the PLC Function Programming Manual.)

### ◀ Parameters referred to ▶

Pr.13 Starting frequency [page 381](#), [page 382](#)

Pr.76 Fault code output selection [page 492](#)

## 5.11.7 Output frequency detection

If the inverter output frequency which reaches a specific value is detected, the relative signal is output.

Pr.	Name	Initial value		Setting range	Description
		FM	CA		
41 M441	Up-to-frequency sensitivity	10%		0 to 100%	Set the level where the SU signal turns ON.
42 M442	Output frequency detection	6 Hz		0 to 590 Hz	Set the frequency at which the FU (or FB) signal turns ON.
43 M443	Output frequency detection for reverse rotation	9999		0 to 590 Hz	Set the frequency at which the FU (or FB) signal turns ON only while the motor rotates in reverse direction.
				9999	The frequency same as the <b>Pr.42</b> setting is set.
50 M444	Second output frequency detection	30 Hz		0 to 590 Hz	Set the frequency at which the FU2 (or FB2) signal turns ON.
116 M445	Third output frequency detection	60 Hz	50 Hz	0 to 590 Hz	Set the frequency at which the FU3 (or FB3) signal turns ON.
865 M446	Low speed detection	1.5 Hz		0 to 590 Hz	Set the frequency at which the LS signal turns ON.
870 M400	Speed detection hysteresis	0 Hz		0 to 5 Hz	Set the hysteresis width for the detected frequency.

## ◆ Setting the notification zone of the output frequency reaching the set point (SU signal, Pr.41)

- The Up to frequency (SU) signal is output when the output frequency reaches the set frequency.
- Set the value in the range of 1 to 100% in **Pr.41** to determine tolerance for the set frequency (considered as 100% point).
- It may be useful to use this signal to start operating related equipment after checking that the set frequency has been reached.

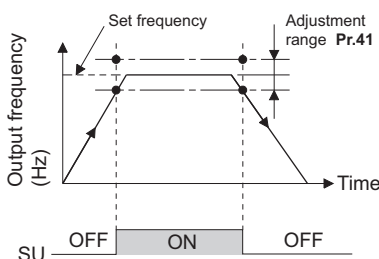

## ◆ Output frequency detection (FU, FU2, FU3 signals, FB, FB2, FB3 signals, Pr.42, Pr.43, Pr.50, Pr.116)

- The Output frequency detection (FU) signal and the Speed detection (FB) signal are output when the output frequency reaches or exceeds the **Pr.42** setting.
- The FU, FU2, and FU3 signals are useful for applying or releasing electromagnetic brake, etc.
- The FU, FU2, and FU3 signal is output when the output frequency (frequency command) reaches the set frequency. On the other hand, the FB, FB2, and FB3 signal is output when the detected actual speed (estimated speed under Real sensorless vector control, or feedback value under Vector control) of the motor reaches the set frequency. The FU signal and the FB signal are output at the same manner under V/F control or Advanced magnetic flux vector control or during the encoder feedback control operation.
- The frequency detection dedicated to motor rotation in reverse direction is enabled by setting the frequency in **Pr.43**. This setting is useful when the timing of the electromagnetic braking during forward rotation operation (for example, during lifting up in the lifts operation) is different from that during reverse rotation operation (lifting down).
- When **Pr.43** ≠ "9999", the **Pr.42** setting is for the forward rotation operation and the **Pr.43** setting is for the reverse rotation operation.
- When a different detection point of the frequency is required, **Pr.50** and **Pr.116** are available. The FU2 (or FB2) signal can be set to be output when the output frequency reaches the **Pr.50** setting or higher, and the FU3 (or FB3) signal can be set to be output when the output frequency reaches the **Pr.116** setting or higher.

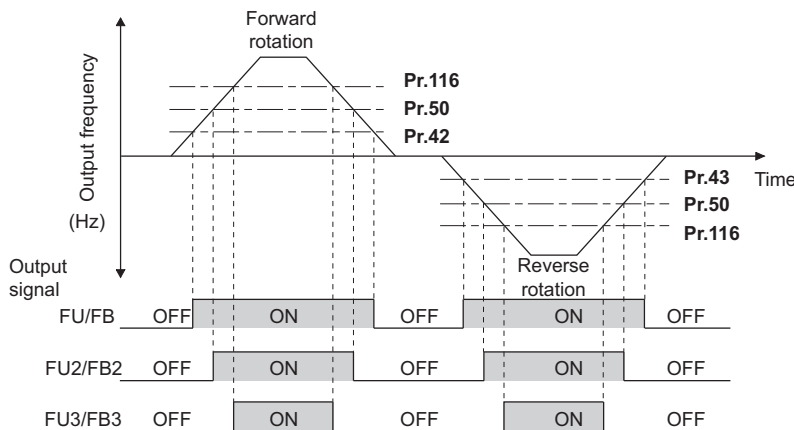

- To use each signal, set the corresponding number selected from the following table in any of **Pr.190 to Pr.196 (Output terminal function selection)** to assign the function to an output terminal.

Output signal	Pr.190 to Pr.196 settings		Related Parameter
	Positive logic	Negative logic	
FU	4	104	42, 43
FB	41	141	
FU2	5	105	50
FB2	42	142	
FU3	6	106	116
FB3	43	143	

## ◆ Low speed detection (LS signal, Pr.865)

- When the output frequency drops to the setting of **Pr.865 Low speed detection** or lower, the Low speed detection (LS) signal is output.
- In the speed control mode under Real sensorless vector control, Vector control, or PM sensorless vector control, the fault occurs, the indication "E.OLT" appears, and the inverter output power shuts off if the inverter condition that the output frequency drops to the **Pr.865** setting and the output torque exceeds the setting of **Pr.874 OLT level setting** by torque limit operation continues for 3 seconds or longer.

- To use the LS signal, set "34 (positive logic) or 134 (negative logic)" in any of **Pr.190 to Pr.196 (Output terminal function selection)** to assign the function to the output terminal.

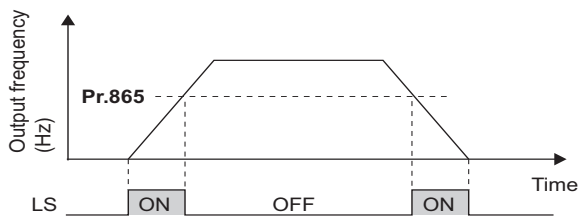

## ◆ Speed detection hysteresis (Pr.870)

Setting the hysteresis width for the detected frequency prevents chattering of the Speed detection (FB) signal. When an output frequency fluctuates, the following signals may chatter (turns ON and OFF repeatedly).

- Up to frequency (SU) signal
- Speed detection (FB, FB2, FB3) signals
- Low speed detection (LS) signal

Setting hysteresis to the detected frequency prevents chattering of these signals.

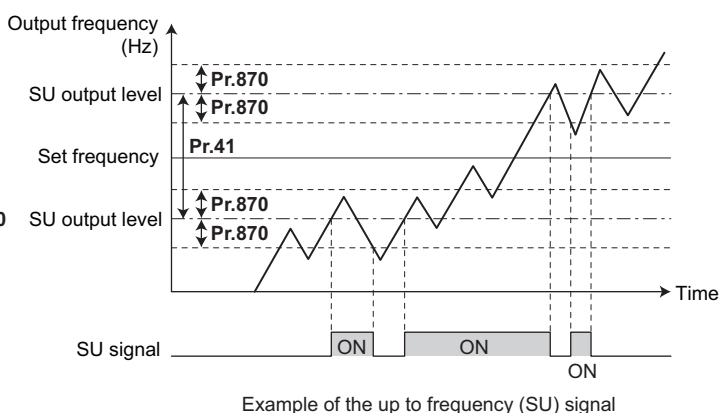
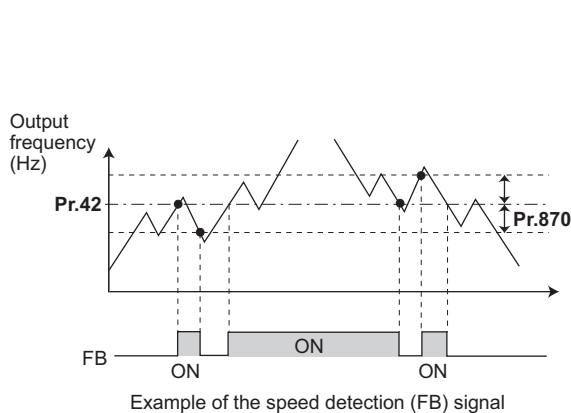

### NOTE

- In the initial setting, the FU signal is assigned to terminal FU, and the SU signal is assigned to terminal SU.
- All signals shown in the following table are OFF during the DC injection brake operation, during the pre-excitation (zero speed control or servo lock) operation, and during tuning at start-up.
- The reference frequency in comparison with the set frequency differs depending on the control method.

Control method or function	Reference frequency	
	FU, FU2, FU3	FB, FB2, FB3, SU, LS
V/F control	Output frequency	Output frequency
Advanced magnetic flux vector control	Output frequency before the slip compensation	Output frequency before the slip compensation
Real sensorless vector control	Frequency command value	Estimated frequency (actual motor speed)
Encoder feedback control	Frequency converted from actual motor speed	Frequency converted from actual motor speed
Vector control	Frequency command value	Frequency converted from actual motor speed
PM sensorless vector control	Frequency command value	Estimated frequency (actual motor speed)

- Setting a higher value in **Pr.870** causes a lower responsivity of the signals for frequency detection (SU, FB, FB2, FB3, and LS signals).
- The logic (ON/OFF switching) of the LS signal is the reverse of that of the FB signal.
- Changing the terminal assignment using **Pr.190 to Pr.196 (Output terminal function selection)** may affect the other functions. Set parameters after confirming the function of each terminal.

### Parameters referred to

**Pr.190 to Pr.196 (Output terminal function selection)** page 473  
**Pr.874 OLT level setting** page 245

## 5.11.8 Output current detection function

If the inverter output current which reaches a specific value is detected, the relative signal is output via an output terminal.

Pr.	Name	Initial value	Setting range	Description
<b>150</b> <b>M460</b>	<b>Output current detection level</b>	150%	0 to 400%	Set the level to detect the output current. Consider the value of the rated inverter current as 100%.
<b>151</b> <b>M461</b>	<b>Output current detection signal delay time</b>	0 s	0 to 10 s	Set the timing to detect the output current. Enter the delay time between the time when the output current reaches the set current or higher and the time when the Output current detection (Y12) signal is output.
<b>152</b> <b>M462</b>	<b>Zero current detection level</b>	5%	0 to 400%	Set the level to detect the zero current. Consider the value of the inverter rated current as 100%.
<b>153</b> <b>M463</b>	<b>Zero current detection time</b>	0.5 s	0 to 10 s	Set the time from the time when the output current drops to the <b>Pr.152</b> setting or lower to the time when the Zero current detection (Y13) signal is output.
<b>166</b> <b>M433</b>	<b>Output current detection signal retention time</b>	0.1 s	0 to 10 s 9999	Set the retention time period during which the Y12 signal is ON. The Y12 signal is retained ON. The signal turns OFF at the next start-up of the inverter.
<b>167</b> <b>M464</b>	<b>Output current detection operation selection</b>	0	0, 1, 10, 11	Select the inverter operation at the time when the Y12 signal and the Y13 signal turn ON.

5

### ◆ Output current detection (Y12 signal, Pr.150, Pr.151, Pr.166, Pr.167)

- The output current detection function is useful for overtorque detection.
- If the inverter output during inverter running remains higher than the **Pr.150** setting for the time set in **Pr.151** or longer, the Output current detection (Y12) signal is output from the inverter's open collector or the relay output terminal.
- When the Y12 signal turns ON, the ON state is retained for the time set in **Pr.166**.
- When **Pr.166** = "9999", the ON state is retained until the next start-up of the inverter.
- Setting **Pr.167** = "1" while the Y12 signal is ON does not cause the fault E.CDO. The **Pr.167** setting becomes valid after the Y12 signal is turned OFF.
- To use the Y12 signal, set "12 (positive logic) or 112 (negative logic)" in any of **Pr.190 to Pr.196 (Output terminal function selection)** to assign the function to the output terminal.
- Use **Pr.167** to select the inverter operation at the time when Y12 signal turns ON, whether the inverter output stops or the inverter operation continues.

Pr.167 setting	When the Y12 signal turns ON	When the Y13 signal turns ON
0 (initial value)	Operation continues.	Operation continues.
1	Operation stops by fault (E.CDO).	Operation continues.
10	Operation continues.	Operation stops by fault (E.CDO).
11	Operation stops by fault (E.CDO).	Operation stops by fault (E.CDO).

Pr.166 ≠ "9999", Pr.167 = "0"

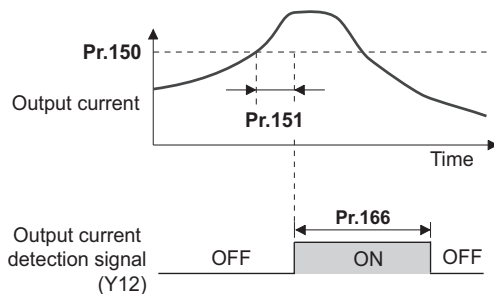

### ◆ Zero current detection (Y13 signal, Pr.152, Pr.153)

- If the inverter output during inverter running remains higher than the **Pr.152** setting for the time set in **Pr.153** or longer, the Zero current detection (Y13) signal is output from the inverter's open collector or the relay output terminal.
- Once the Zero current detection (Y13) signal turns ON, the signal is retained ON for at least 0.1 second.

- If the inverter output current drops to zero, slippage due to gravity may occur, especially in a lift application, because the motor torque is not generated. To prevent this, the Y13 signal can be output from the inverter to apply the mechanical brake at zero current output.
- To use the Y13 signal, set "13 (positive logic) or 113 (negative logic)" in any of **Pr.190 to Pr.196 (Output terminal function selection)** to assign the function to the output terminal.
- Use **Pr.167** to select the inverter operation at the time when Y13 signal turns ON, whether the inverter output stops or the inverter operation continues.

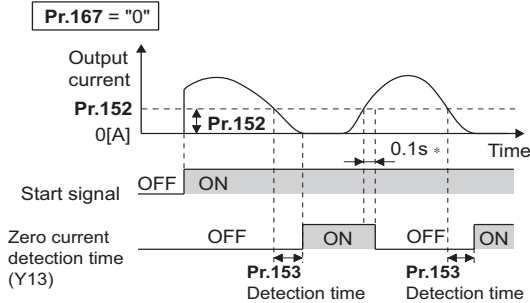

\* When the output is restored to the **Pr.152** level, the Y13 signal is turned OFF after 0.1 s.

## NOTE

- This function is enabled during online or offline auto tuning.
- The response time of the Y12 and Y13 signals is approximately 0.1 second. However, the response time varies according to the load condition.
- When **Pr.152** = "0", the zero current detection function is disabled.
- Changing the terminal assignment using **Pr.190 to Pr.196 (Output terminal function selection)** may affect the other functions. Set parameters after confirming the function of each terminal.

## CAUTION

- The setting of the zero current detection level should not be too low, and the setting of the zero current detection time should not be too long. Doing so may cause the signal for the zero current detection not to be outputted when the output current is very low and the motor torque is not generated.
- A safety backup such as an emergency brake must be provided to prevent machines or equipment in hazardous conditions even if the Zero current detection is used.

### Parameters referred to

Online auto tuning [page 558](#)

Offline auto tuning [page 532](#), [page 551](#)

Pr.190 to Pr.196 (Output terminal function selection) [page 473](#)

## 5.11.9 Output torque detection function

Magnetic flux Sensorless Vector PM

If the motor torque which reaches a specific value is detected, the relative signal is output.

The signal is useful for applying or releasing electromagnetic brake, etc.

Pr.	Name	Initial value	Setting range	Description
<b>864</b> <b>M470</b>	Torque detection	150%	0 to 400%	Set a value of the torque at which the TU signal turns ON.

- The Torque detection (TU) signal turns ON when the motor output torque reaches the value of torque set in **Pr.864** or higher. The TU signal turns OFF when the motor output torque drops lower than the set value.
- **Pr.864** is not available under V/F control.

- To use the TU signal, set "35 (positive logic) or 135 (negative logic)" in one of **Pr.190 to Pr.196 (Output terminal function selection)** to assign the function to the output terminal.

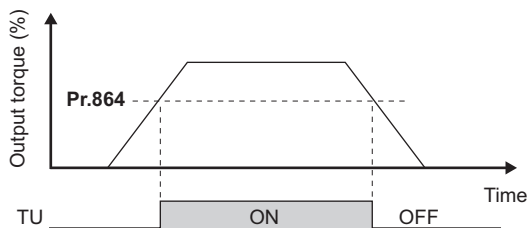

### NOTE

- Changing the terminal assignment using **Pr.190 to Pr.196 (Output terminal function selection)** may affect the other functions. Set parameters after confirming the function of each terminal.

### Parameters referred to

Pr.190 to Pr.196 (Output terminal function selection) [page 473](#)

## 5.11.10 Remote output function

The signal can be turned ON or OFF via the output terminal on the inverter as if the terminal is the remote output terminal for a programmable controller.

Pr.	Name	Initial value	Setting range	Description
495 M500	Remote output selection	0	0	Remote output data is cleared when the inverter power is turned OFF.
			1	Remote output data is retained even after the inverter power is turned OFF.
			10	Remote output data is cleared when the inverter power is turned OFF.
			11	Remote output data is retained even after the inverter power is turned OFF.
496 M501	Remote output data 1	0	0 to 4095	Set a decimal number to enter a binary number in every bit corresponding to each of the output terminals on the inverter.
497 M502	Remote output data 2	0	0 to 4095	Set a decimal number to enter a binary number in every bit corresponding to each of the output terminals on the option FR-A8AY or FR-A8AR.

### ◆ Remote output setting (REM signal, Pr.496, Pr.497)

- The signal assigned to each of the output terminal can be turned ON or OFF according to the settings of **Pr.496** and **Pr.497**. The signal assigned to each of the remote output terminal can be turned ON or OFF through communication via the PU connector, via the RS-485 terminals, or via a communication option.
- To use the Remote output (REM) signal, set "96 (positive logic) or 196 (negative logic)" in any of **Pr.190 to Pr.196 (Output terminal function selection)** to assign the function to the terminal.
- Refer to the following figures to check correspondences between the bit and the actual terminal. When "1" is set in the bit corresponding to the terminal to which the REM signal assigned by setting a number in **Pr.496** and **Pr.497** each, the signal turns ON (or OFF in negative logic setting). Also, setting "0" allows the signal to turn OFF (or ON in negative logic setting).
- For example, when **Pr.190 RUN terminal function selection** = "96" (positive logic) and "1" (H01) is set in **Pr.496**, the REM signal assigned to terminal RUN turns ON.

#### Pr.496

b11												b0
*1	*1	*1	*1	*1	ABC2	ABC1	FU	OL	IPF	SU	RUN	

**Pr.497**

b11										b0	
*1	*1	RA3 *3	RA2 *3	RA1 *3	Y6 *2	Y5 *2	Y4 *2	Y3 *2	Y2 *2	Y1 *2	Y0 *2

- \*1 Any value
- \*2 Y0 to Y6 are available when the output-extending option (FR-A8AY) is installed.
- \*3 RA1 to RA3 are available when the relay output option (FR-A8AR) is installed.

**◆ Remote output data retention (REM signal, Pr.495)**

- When the inverter power is reset (or a power failure occurs) while **Pr.495** = "0 (initial value) or 10", the REM signal setting is cleared. (The ON/OFF state of the signal assigned to each terminal is determined by the settings in **Pr.190 to Pr.196**.) The settings in **Pr.496** and **Pr.497** are reset to "0".
- When **Pr.495** = "1 or 11", the remote output data is stored in EEPROM before the inverter power is turned OFF. This means that the signal output setting after power restoration is the same as that before the power was turned OFF. However, when **Pr.495** = "1", the data during an inverter reset (terminal reset or reset request via communication) is not saved.
- When **Pr.495** = "10 or 11", the remote output data in the signal before the reset is stored even during an inverter reset.

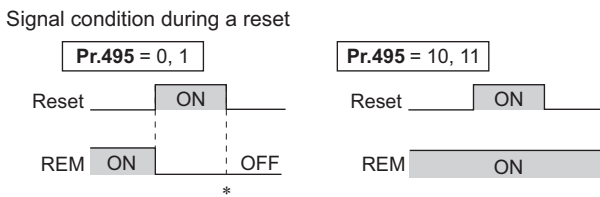
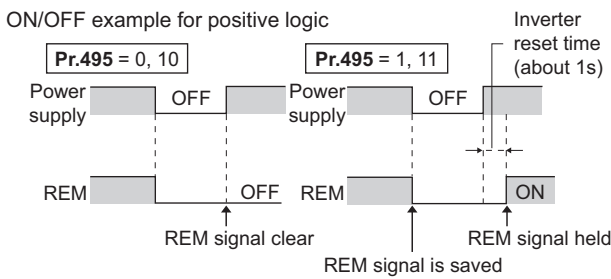

\* When **Pr.495** = "1", the signal condition saved in EEPROM (condition of the last power OFF) is applied.

**NOTE**

- The output terminal to which the REM signal is not assigned by using **Pr.190 to Pr.196** does not turn ON or OFF when "1 or 0" is set in bit corresponding to each of the terminals by using **Pr.496** and **Pr.497**. (ON/OFF command affects only the terminal to which the REM signal is assigned.)
- When **Pr.495** = "1 or 11" (remote output data retained at power OFF), take measures to keep the control circuit power ON, such as connecting terminal R1/L11 with terminal P/+ and connecting terminal S1/L21 with terminal N/-. If the control power is not retained, the output signal after the inverter power turns ON is not guaranteed to work. When the high power factor converter (FR-HC2) or the converter unit (FR-CC2) is connected to the inverter, assign the FR-HC2/FR-CC2 connection, instantaneous power failure detection (X11) signal to an input terminal and input the IPF signal from the FR-HC2/FR-CC2 to the inverter via the terminal to which the X11 signal is assigned.

Parameters referred to

Pr.190 to Pr.196 (Output terminal function selection) [page 473](#)

**5.11.11 Analog remote output function**

An analog value can be output via the analog output terminal on the inverter.

Pr.	Name	Initial value	Setting range	Description
655 M530	Analog remote output selection	0	0	Remote output data is cleared when the inverter power is turned OFF.
			1	Remote output data is retained even after the inverter power is turned OFF.
			10	Remote output data is cleared when the inverter power is turned OFF.
			11	Remote output data is retained even after the inverter power is turned OFF.
656 M531	Analog remote output 1	1000%	800 to 1200%	Value output via the terminal for which "87" is set in the terminal function selection parameter (Pr.54 or Pr.158)
657 M532	Analog remote output 2	1000%	800 to 1200%	Value output via the terminal for which "88" is set in the terminal function selection parameter (Pr.54 or Pr.158)
658 M533	Analog remote output 3	1000%	800 to 1200%	Value output via the terminal for which "89" is set in the terminal function selection parameter (Pr.54 or Pr.158)
659 M534	Analog remote output 4	1000%	800 to 1200%	Value output via the terminal for which "90" is set in the terminal function selection parameter (Pr.54 or Pr.158)

### ◆ Analog remote output (Pr.656 to Pr.659)

- The analog signal of the value set in **Pr.656 to Pr.659 (Analog remote output)** can be output via terminal FM or CA, terminal AM and the analog output terminal on the option FR-A8AY.
- When **Pr.54 FM/CA terminal function selection** = "87, 88, 89, or 90" (Remote output value), the type FM inverter can output a pulse train via terminal FM.
- For FM output (when **Pr.291 Pulse train I/O selection** = "0 (initial value) or 1"):
 
$$\text{Terminal FM output [pulses/s]} = 1440 \text{ [Hz]} \times (\text{Analog remote output value} - 1000)/100$$
 Where the output range is 0 to 2400 pulses/s.
- For high-speed pulse output (when **Pr.291 Pulse train I/O selection** = "10, 11, 20, or 21"):
 
$$\text{Terminal FM output [pulses/s]} = 50\text{k [Hz]} \times (\text{Analog remote output value} - 1000)/100$$
 Where the output range is 0 to 55k pulses/s.

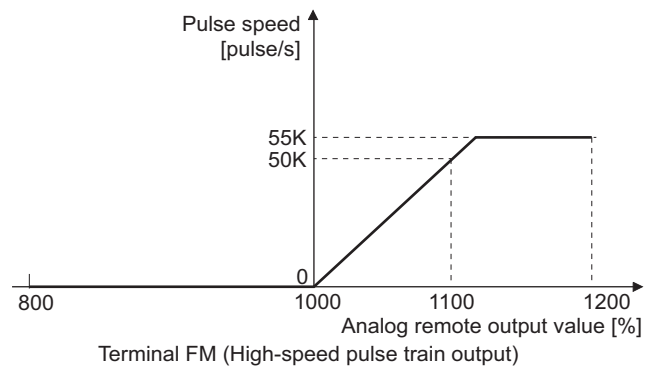
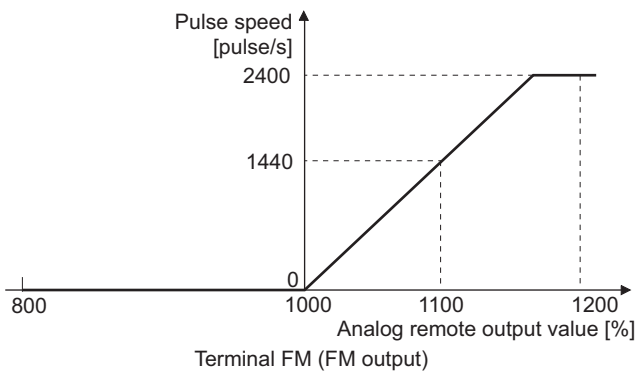

- When **Pr.54 FM/CA terminal function selection** = "87, 88, 89, or 90" (remote output), the type CA inverter can output any analog current via terminal CA.
- Terminal CA output [mA] =  $20 \text{ [mA]} \times (\text{Analog remote output value} - 1000)/100$   
Where the output range is 0 to 20 mA.

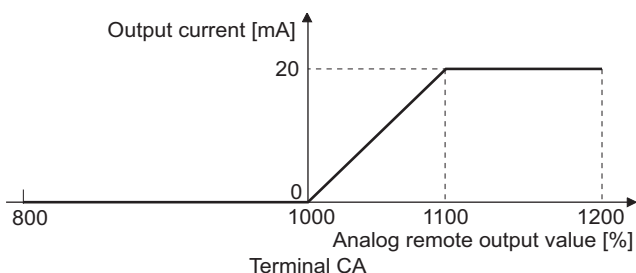



- When **Pr.158 AM terminal function selection** = "87, 88, 89, or 90", an analog voltage can be output via terminal AM.
- Terminal AM output [V] = 10 [V] × (Analog remote output value - 1000)/100

The output range is -10 to +10 V regardless of the **Pr.290 Monitor negative output selection** setting.

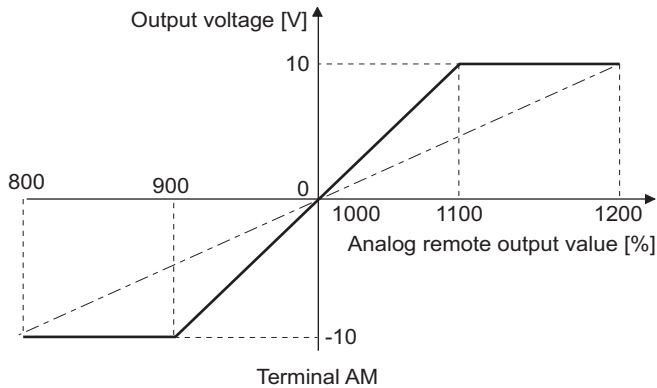

### ◆ Analog remote output data retention (Pr.655)

- When the power supply is reset (including a power failure) while **Pr.655 Analog remote output selection** = "0" (initial value) or 10" and, the remote analog output (**Pr.656 to Pr.659**) returns to its initial value (1000%).
- When **Pr.655** = "1 or 11", the remote output data is stored in EEPROM before the inverter power is turned OFF. This means that the signal output setting after power restoration is the same as that before the power was turned OFF. However, when **Pr.655** = "1", the data during an inverter reset (terminal reset or reset request via communication) is not saved.
- When **Pr.655** = "10 or 11", the remote output data in the signal before the reset is stored even during an inverter reset.
- When the setting in **Pr.655** is changed, the remote analog output (**Pr.656 to Pr.659**) returns to its initial value (1000%).

ON/OFF example for positive logic

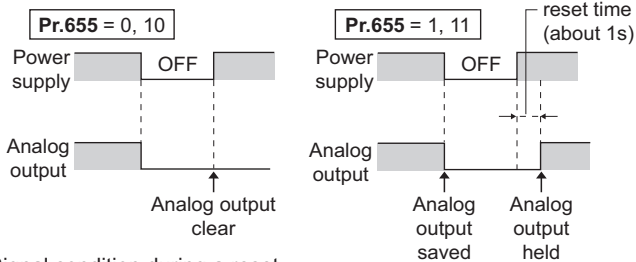

Signal condition during a reset

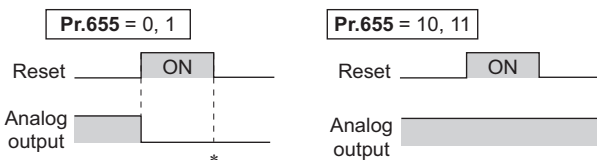

\* When **Pr.655** = "1", the signal condition saved in EEPROM (condition of the last power OFF) is applied.

#### NOTE

- When **Pr.655** = "1 or 11" (remote output data retained at power OFF), take measures to keep the control circuit power ON, such as connecting terminal R1/L11 with terminal P/+ and connecting terminal S1/L21 with terminal N/- (while power is supplied via input terminals R/L1, S/L2 and T/L3). If the control power is not retained, the output signal after the inverter power turns ON is not guaranteed to work. When connecting the high power factor converter FR-HC2, assign the instantaneous power failure detection (X11) signal to an input terminal to input the IPF signal from the FR-HC2 to the terminal for X11 signal.

#### Parameters referred to

- Pr.54 FM/CA terminal function selection [page 457](#)
- Pr.158 AM terminal function selection [page 457](#)
- Pr.290 Monitor negative output selection [page 457](#)
- Pr.291 Pulse train I/O selection [page 457](#)

## 5.11.12 Fault code output selection

When a fault occurs, the corresponding data can be output as a 4-bit digital signal using via an open collector output terminal. The fault code can be read using an input module of programmable controller, etc.

Pr.	Name	Initial value	Setting range	Description
76 M510	Fault code output selection	0	0	Without fault code output
			1	With fault code output
			2	Fault code is output only when a fault occurs

- Fault codes can be output to the output terminals by setting **Pr.76 Fault code output selection** = "1 or 2".
- When the setting is "2", a fault code is only output when a fault occurs. In normal operation the terminal outputs the signal assigned in **Pr.191 to Pr.194 (Output terminal function selection)**.
- The fault codes that can be output are shown in the following table. (0: Output transistor OFF, 1: Output transistor ON)

Operation panel indication (FR-DU08)	Output terminal operation				Fault code
	SU	IPF	OL	FU	
Normal <sup>*1</sup>	0	0	0	0	0
E.OC1	0	0	0	1	1
E.OC2	0	0	1	0	2
E.OC3	0	0	1	1	3
E.OV1 to E.OV3	0	1	0	0	4
E.THM	0	1	0	1	5
E.THT	0	1	1	0	6
E.IPF	0	1	1	1	7
E.UVT	1	0	0	0	8
E.FIN	1	0	0	1	9
E.BE	1	0	1	0	A
E.GF	1	0	1	1	B
E.OHT	1	1	0	0	C
E.OLT	1	1	0	1	D
E.OPT, E.OP1 to E.OP3	1	1	1	0	E
Terminals other than the above	1	1	1	1	F

\*1 When **Pr.76** = "2", the terminal outputs the signal assigned by **Pr.191 to Pr.194**.

#### NOTE

- If an error occurs while **Pr.76** ≠ "0", the output terminals SU, IPF, OL, and FU output the signals in the table above regardless of the settings in **Pr.191 to Pr.194 (Output terminal function selection)**. Take caution when controlling the inverter with the output signals set by **Pr.191 to Pr.194**.

#### Parameters referred to

**Pr.190 to Pr.196 (Output terminal function selection)**  page 473

## 5.11.13 Pulse train output to announce cumulative output energy

Every time when the output energy cumulated from the time at power ON or at an inverter reset or when the setting of **Pr.799 Pulse increment setting for output power** has been changed increments by the set value, the Pulse train output of output power (Y79) signal is output in pulses.

Pr.	Name	Initial value	Setting range	Description
799 M520	Pulse increment setting for output power	1 kWh	0.1 kWh, 1 kWh, 10 kWh, 100 kWh, 1000 kWh	The Pulse train output of output power (Y79) signal is output in pulses every time when the output energy increments by the set amount of energy (kWh).

### ◆ Pulse increment setting for output power (Y79 signal, Pr.799)

- Every time when the output energy cumulated from the time at power ON or at an inverter reset increments by the set value of **Pr.799 Pulse increment setting for output power**, the Pulse train output of output power (Y79) signal is output in pulses.

- The inverter does not stop cumulating (can continue to cumulate) the output energy even if the retry function or the automatic restart after instantaneous power failure function works because the cause of the function activation is a mini power failure which is too short to cause an inverter reset.
- If a power failure occurs, the cumulative value is reset to 0 kWh and restart cumulating.
- To use the Y79 signal, set "79 (positive logic) or 179 (negative logic)" in any of **Pr.190 to Pr.196 (Output terminal function selection)** to assign the function to the output terminal.

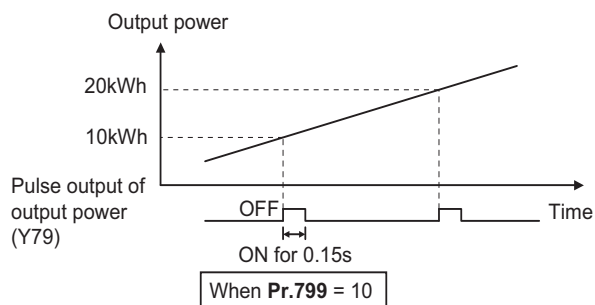

#### NOTE

- Because the accumulated data in the inverter is cleared when control power is lost by power failure or at an inverter reset, the value on the monitor cannot be used to charge electricity bill.
- Changing the terminal assignment using **Pr.190 to Pr.196 (Output terminal function selection)** may affect the other functions. Set parameters after confirming the function of each terminal. (Refer to [page 473](#).)
- Do not assign the signal to terminal ABC1 or terminal ABC2 whose pulse outputs are frequently turned ON/OFF. Otherwise, the life of the relay contact may be shortened.

#### Parameters referred to

Pr.190 to Pr.196 (Output terminal function selection) [page 473](#)

## 5.11.14 Detection of control circuit temperature

The temperature of the control circuit board can be monitored, and a signal can be output according to a predetermined temperature setting.

Pr.	Name	Initial value	Setting range	Description
<b>663</b> M060	<b>Control circuit temperature signal output level</b>	0°C	0 to 100°C	Set the temperature where the Y207 signal turns ON.

### ◆ Control circuit temperature monitoring

- The temperature of the control circuit board can be monitored within the range of 0 to 100°C on the operation panel, or via terminal FM/CA, or terminal AM. Refer to [page 446](#) for information on how to select the monitor item.
- When **Pr.290 Monitor negative output selection** is set to enable display of the negative numbers for monitoring on the operation panel or via terminal AM, the range of monitoring is -20 to 100°C.
- The monitor value is a rough approximation of the change in the surrounding air temperature of the inverter. Use this parameter to grasp the operating environment of the inverter.

### ◆ Control circuit temperature detection (Pr.663, Y207 signal)

- The Y207 signal can be output when the control circuit temperature reaches the **Pr.663** setting or higher.
- To use the Y207 signal, set "207 (positive logic) or 307 (negative logic)" in any of **Pr.190 to Pr.196 (Output terminal function selection)** to assign the function to the output terminal.

#### NOTE

- The Y207 signal is turned OFF when the control circuit temperature becomes 5°C or more lower than the **Pr.663** setting.
- Changing the terminal assignment using **Pr.190 to Pr.196 (Output terminal function selection)** may affect the other functions. Set parameters after confirming the function of each terminal.

#### Parameters referred to

Pr.54 FM/CA terminal function selection [page 457](#)

Pr.158 AM terminal function selection [page 457](#)

Pr.190 to Pr.196 (Output terminal function selection) [page 473](#)

Pr.290 Monitor negative output selection [page 457](#)

## 5.11.15 Encoder pulse dividing output

The encoder pulse signal at the motor end can be divided in division ratio set in the parameter and be output.

Use this parameter to make the response of the machine to be input slower, etc. The FR-A8AL or the FR-A8TP is required to be installed.

Pr.	Name	Initial value	Setting range	Description
<b>413</b> <b>M601</b> <sup>*1</sup>	<b>Encoder pulse division ratio</b>	1	1 to 32767	Set a numerical value by which pulses are divided.
<b>863</b> <b>M600</b> <sup>*2</sup>	<b>Control terminal option-Encoder pulse division ratio</b>			

\*1 This parameter is available when the FR-A8AL (option) is installed.

\*2 This parameter is available when the FR-A8TP (option) is installed.

- Division waveform by division ratio

Both ON-OFF width is division times (50% duty).

- Pulse waveform example at 1000 pulse input when **Pr.413** or **Pr.863** = "2"

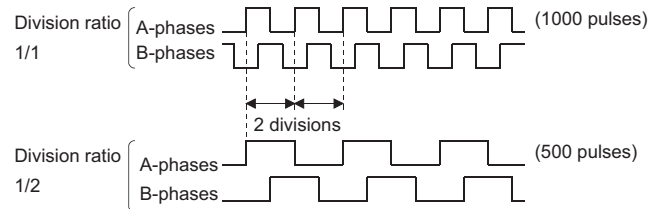

### NOTE

- Control of motor rotation (forward or reverse) by phase difference between A phase and B phase is as follows.  
When A phase is 90° advanced as compared to B phase: Forward rotation  
When A phase is 90° behind as compared to B phase: Reverse rotation

## 5.12 (T) Multi-function input terminal parameters

Purpose	Parameter to set			Refer to page
To inverse the rotation direction with the voltage/current analog input selection (terminals 1, 2, and 4)	Analog input selection	P.T000, P.T001	Pr.73, Pr.267	496
To assign functions to analog input terminals	Terminal 1 and terminal 4 function assignment	P.T010, P.T040	Pr.858, Pr.868	500
To adjust the main speed by the analog auxiliary input	Analog auxiliary input and compensation (addition compensation and override functions)	P.T000, P.T021, P.T041, P.T050, P.T051	Pr.73, Pr.242, Pr.243, Pr.252, Pr.253	501
To eliminate noise on analog inputs	Analog input filter	P.T002 to P.T007	Pr.74, Pr.822, Pr.826, Pr.832, Pr.836, Pr.849	503
To adjust analog input frequency/voltage (current) (calibration)	Frequency setting voltage (current) bias and gain	P.T100 to P.T103, P.T200 to P.T203, P.T400 to P.T403, P.M043	Pr.125, Pr.126, Pr.241, C2 to C7 (Pr.902 to Pr.905), C12 to C15 (Pr.917 to Pr.918)	505
To adjust analog input torque/voltage (current) (calibration)	Torque setting voltage (current) bias and gain	P.T110 to P.T113, P.T410 to P.T413, P.M043	Pr.241, C16 to C19 (Pr.919 to Pr.920), C38 to C41 (Pr.932 to Pr.933)	510
To continue operating at analog current input loss	4 mA input check	P.T052 to P.T054	Pr.573, Pr.777, Pr.778	517
To assign functions to input terminals	Input terminal function selection	P.T700 to P.T711, P.T740	Pr.178 to Pr.189, Pr.699	521
To change the input specification (NO/NC contact) of input signals	Output stop (MRS) signal input selection	P.T720	Pr.17	524
	Inverter run enable (X10) signal input selection	P.T721	Pr.599	727
	Power failure stop external (X48) signal input selection	P.T722	Pr.606	642
To enable the second function only during the constant speed	RT signal function validity condition selection	P.T730	Pr.155	525
To assign start and forward/reverse commands to different signals	Start signal (STF/STR) operation selection	P.G106	Pr.250	722

### 5.12.1 Analog input selection

The functions to switch the analog input terminal specifications, override function, forward/reverse rotation by the input signal polarity are selectable.

Pr.	Name	Initial value	Setting range		Description
73 T000	Analog input selection	1	0 to 5, 10 to 15	Switch 1 - OFF (initial status)	The terminal 2 input specification (0 to 5 V, 0 to 10 V, 0 to 20 mA) and terminal 1 input specification (0 to $\pm 5$ V, 0 to $\pm 10$ V) are selectable. Also the override and reversible operation settings are selectable.
			6 to 7, 16, 17	Switch 1 - ON	
267 T001	Terminal 4 input selection	0	0	Switch 2 - ON (initial status)	Terminal 4 input, 4 to 20 mA
			1	Switch 2 - OFF	Terminal 4 input, 0 to 5 V
			2		Terminal 4 input, 0 to 10 V

## ◆ Analog input specification selection

- For terminals 2 and 4 used for analog input, the voltage input (0 to 5 V, 0 to 10 V) and current input (0 to 20 mA) are selectable. To change the input specification, change the setting of **Pr.73 (Pr.267)** and the voltage/current input selection switch (switch 1 or switch 2).

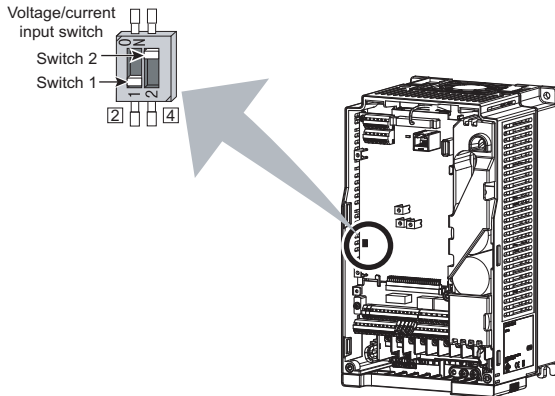

Switch state		Input specification	Input terminal	Rated specification
Switch 1	ON	Current input	Terminal 2	For voltage input, the input resistance is $10\pm 1\text{ k}\Omega$ and the maximum permissible voltage is 20 VDC. For current input, the input resistance is $245\pm 5\ \Omega$ and the maximum permissible current is 30 mA.
	OFF	Voltage input (initial status)		
Switch 2	ON	Current input (initial status)	Terminal 4	
	OFF	Voltage input		

- Change the setting of the voltage/current input selection switch to change the rated specification of terminal 2 or 4.
- Set **Pr.73 (Pr.267)** and the voltage/current input selection switch according to the analog signal input. The incorrect settings shown in the following table cause a failure. The inverter does not operate properly with other incorrect settings.

Setting causing a failure		Operation
Switch setting	Terminal input	
ON (Current input)	Voltage input	Causes an analog signal output circuit failure in an external device (due to increased loads on the signal output circuit of the external device).
OFF (Voltage input)	Current input	Causes an input circuit failure in the inverter (due to an increased output power in the analog signal output circuit of an external device).

### NOTE

- Check the number of the voltage/current input selection switch before setting, because it is different from the switch number indicated on the FR-A700 series inverter.

Set **Pr.73** and the voltage/current input selection switch according to the following table.

Pr.73 setting	Terminal 2 input	Switch 1	Terminal 1 input	Compensation input terminal compensation method	Reversible polarity	
0	0 to 10 V <sup>*1</sup>	OFF	0 to ±10 V	Terminal 1 addition compensation	Not applied (state in which a negative polarity frequency command signal is not accepted)	
1 (initial value)	0 to 5 V <sup>*1</sup>	OFF	0 to ±10 V			
2	0 to 10 V <sup>*1</sup>	OFF	0 to ±5 V			
3	0 to 5 V <sup>*1</sup>	OFF	0 to ±5 V			
4	0 to 10 V	OFF	0 to ±10 V <sup>*1</sup>	Terminal 2 override		
5	0 to 5 V	OFF	0 to ±5 V <sup>*1</sup>			
6	0 to 20 mA <sup>*1</sup>	ON	0 to ±10 V	Terminal 1 addition compensation		Applied
7	0 to 20 mA <sup>*1</sup>	ON	0 to ±5 V			
10	0 to 10 V <sup>*1</sup>	OFF	0 to ±10 V			
11	0 to 5 V <sup>*1</sup>	OFF	0 to ±10 V			
12	0 to 10 V <sup>*1</sup>	OFF	0 to ±5 V			
13	0 to 5 V <sup>*1</sup>	OFF	0 to ±5 V			
14	0 to 10 V	OFF	0 to ±10 V <sup>*1</sup>			
15	0 to 5 V	OFF	0 to ±5 V <sup>*1</sup>	Terminal 2 override		
16	0 to 20 mA <sup>*1</sup>	ON	0 to ±10 V	Terminal 1 addition compensation		
17	0 to 20 mA <sup>*1</sup>	ON	0 to ±5 V			

\*1 The main speed setting is indicated.

- When the Terminal 4 input selection (AU) signal is turned ON, terminal 4 is used to set the main speed. In this case, terminals 1 and 2 are not used to set the main speed.
- Set **Pr.267** and the voltage/current input selection switch according to the following table.

Pr.267 setting	Terminal 4 input	Switch 2
0 (initial value)	4 to 20 mA	ON
1	0 to 5 V	OFF
2	0 to 10 V	OFF

**NOTE**

- To enable terminal 4, turn ON the AU signal.
- Set the parameters and the switch settings so that they agree. Incorrect setting may cause a fault, failure, or malfunction.
- The frequency setting auxiliary input through terminal 1 is added to the main speed setting signal input through terminal 2 or 4.
- When the override setting is selected, terminal 1 or 4 is set to the main speed setting, and terminal 2 is set to the override signal (0 to 5 V or 0 to 10 V, and 50% to 150%). (If the main speed signal is not input through terminal 1 or 4, the compensation by terminal 2 is disabled.)
- Use **Pr.125 (Pr.126) (frequency setting gain)** to change the maximum output frequency at the input of the maximum output frequency command voltage (current). At this time, the command voltage (current) need not be input. Also, the acceleration/deceleration time, which is a slope up/down to the acceleration/deceleration reference frequency, is not affected by the change in **Pr.73** setting.
- When "4" is set in **Pr.858 Terminal 4 function assignment (Pr.868 Terminal 1 function assignment)**, the stall prevention operation level is input through terminal 1 (4). To input frequency through terminal 1 (4), set "0 (initial value)" in **Pr.858 (Pr.868)**.
- Always calibrate the input after changing the voltage/current input signal with **Pr.73 (Pr.267)** and the voltage/current input selection switch.
- When **Pr.561 PTC thermistor protection level** ≠ "9999", terminal 2 is not used for the analog frequency command.

**◆ Running with analog input voltage**

- For the frequency setting signal, input 0 to 5 VDC (or 0 to 10 VDC) between terminals 2 and 5. The 5 V (10 V) input is the maximum output frequency.

- The power supply 5 V (10 V) can be input by either using the internal power supply or preparing an external power supply. The internal power supply is 5 VDC output between terminals 10 and 5, and 10 VDC output between terminals 10E and 5.

Terminal	Inverter internal power source voltage	Frequency setting resolution	Pr.73 (terminal 2 input voltage)
10	5 VDC	0.030/60 Hz	0 to 5 VDC input
10E	10 VDC	0.015/60 Hz	0 to 10 VDC input

- To supply the 10 VDC input to terminal 2, set "0, 2, 4, 10, 12, or 14" in **Pr.73**. (The initial value is 0 to 5 V.)
- Set "1 (0 to 5 VDC)" or "2 (0 to 10 VDC)" in **Pr.267** and turn OFF the voltage/current input selection switch to input voltage through terminal 4. Turning ON the AU signal activates the terminal 4 input.

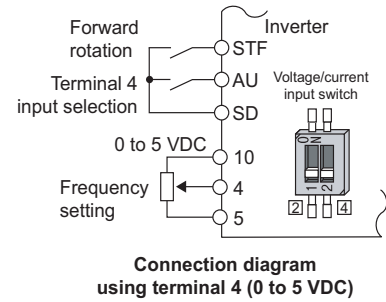
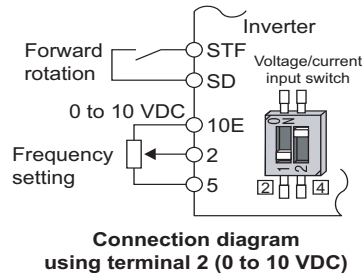
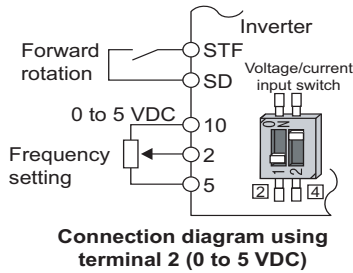

### NOTE

- The wiring length of terminal 10, 2, and 5 should be 30 m at maximum.

## ◆ Running with analog input current

- For constant pressure or temperature control with fans, pumps, or other devices, automatic operation is available by setting the regulator output signal 4 to 20 mADC to between terminals 4 and 5.
- To use terminal 4, the AU signal needs to be turned ON.

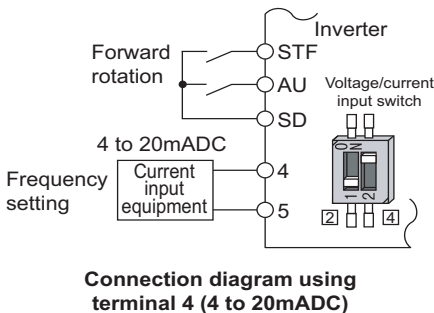

- Set "6, 7, 16, or 17" in **Pr.73** and turn ON the voltage/current input selection switch to input current through terminal 2. In this case, the AU signal does not need to be turned ON.

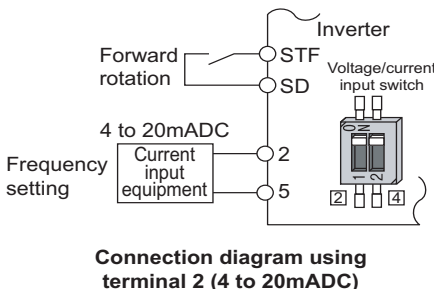

## ◆ Performing forward/reverse rotation with the analog input (polarity reversible operation)

- Setting "10 to 17" in **Pr.73** enables the polarity reversible operation.



- Set a positive or negative input (0 to  $\pm 5$  V or 0 to  $\pm 10$  V) to terminal 1 to allow the operation of forward/reverse rotation according to the polarity of the input value.

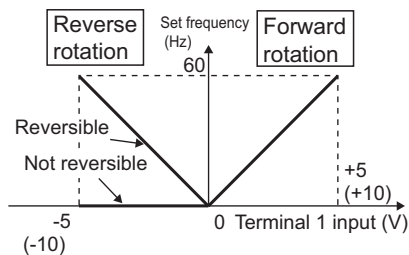

Compensation input characteristics when STF is ON

### Parameters referred to

Pr.22 Stall prevention operation level [page 431](#)

Pr.125 Terminal 2 frequency setting gain frequency, Pr.126 Terminal 4 frequency setting gain frequency [page 505](#)

Pr.252, Pr.253 Override bias/gain [page 501](#)

Pr.561 PTC thermistor protection level [page 415](#)

Pr.858 Terminal 4 function assignment, Pr.868 Terminal 1 function assignment [page 500](#)

## 5.12.2 Analog input terminal (terminal 1, 4) function assignment

The analog input terminal 1 and terminal 4 functions are set and changeable with parameters.

Pr.	Name	Initial value	Setting range	Description
868 T010	Terminal 1 function assignment	0	0 to 6, 9999	Select the terminal 1 function.
858 T040	Terminal 4 function assignment	0	0, 1, 4, 9999	Select the terminal 4 function.

- For terminals 1 and 4 used for analog input, the frequency (speed) command, magnetic flux command, torque command, and other similar commands are usable. The functions available are different depending on the control method and control mode as shown in the following table. (For details on the control methods, refer to [page 221](#).)
- Functions of terminal 1 under different control modes

Pr.868 setting	V/F control, Advanced magnetic flux vector control	Real sensorless vector control, Vector control, PM sensorless vector control		
		Speed control	Torque control	Position control
0 (initial value)	Auxiliary frequency setting	Auxiliary speed setting	Auxiliary speed limit	—
1	—	Magnetic flux command <sup>*1</sup>	Magnetic flux command <sup>*1</sup>	Magnetic flux command <sup>*1</sup>
2	—	Regenerative torque limit (Pr.810 = "1")	—	Regenerative torque limit (Pr.810 = "1")
3	—	—	Torque command (Pr.804 = "0")	—
4	Stall prevention operation level input	Torque limit (Pr.810 = "1")	Torque command (Pr.804 = "0")	Torque limit (Pr.810 = "1")
5	—	—	Forward/reverse rotation speed limit (Pr.807 = "2")	—
6	—	Torque bias input (Pr.840 = "1, 2, or 3")	—	—
9999	—	—	—	—

- Functions of terminal 4 under different control modes

Pr.858 setting	V/F control, Advanced magnetic flux vector control	Real sensorless vector control, Vector control, PM sensorless vector control		
		Speed control	Torque control	Position control
0 (initial value)	Frequency command (AU signal-ON)	Speed command (AU signal-ON)	Speed limit (AU signal-ON)	—
1	—	Magnetic flux command <sup>*1*2</sup>	Magnetic flux command <sup>*1*2</sup>	Magnetic flux command <sup>*1*2</sup>
4	Stall prevention operation level input	Torque limit (Pr.810 = "1") <sup>*3</sup>	—	Torque limit (Pr.810 = "1") <sup>*3</sup>
9999	—	—	—	—

—: No function

- \*1 This function is valid under Vector control.
- \*2 Invalid when **Pr.868** = "1".
- \*3 Invalid when **Pr.868** = "4".

**NOTE**

- When **Pr.868** = "1" (magnetic flux command) or "4" (stall prevention / torque limit), the terminal 4 function is enabled regardless of the ON/OFF state of the AU signal.

«Parameters referred to»

- Advanced magnetic flux vector control [page 228](#)
- Real sensorless vector control [page 221](#)
- Pr.804 Torque command source selection [page 283](#)
- Pr.807 Speed limit selection [page 287](#)
- Pr.810 Torque limit input method selection [page 245](#)
- Pr.840 Torque bias selection [page 265](#)

### 5.12.3 Analog input compensation

The analog input for multi-speed operation or speed setting (main speed) through terminal 2 or 4 can be compensated by adding an input, or terminal 2 can be used for an auxiliary input to compensate the analog input at a fixed ratio using the override function.

Pr.	Name	Initial value	Setting range	Description
73 T000	Analog input selection	1	0 to 3, 6, 7, 10 to 13, 16, 17	Compensation by addition
			4, 5, 14, 15	Compensation using the override function
242 T021	Terminal 1 added compensation amount (terminal 2)	100%	0 to 100%	Set the percentage of addition when terminal 2 is used to set the main speed.
243 T041	Terminal 1 added compensation amount (terminal 4)	75%	0 to 100%	Set the percentage of addition when terminal 4 is used to set the main speed.
252 T050	Override bias	50%	0 to 200%	Set bias compensation for the override function.
253 T051	Override gain	150%	0 to 200%	Set gain compensation for the override function.

#### ◆ Compensation by addition (Pr.242, Pr.243)

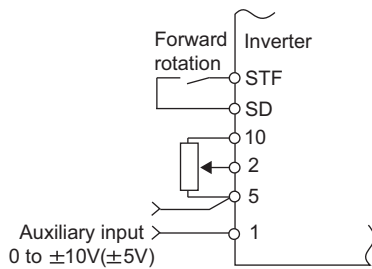

Example of addition compensation connection

- A compensation signal can be added to the main speed setting for such as synchronous or continuous speed control operation.
- Set "0 to 3, 6, 7, 10 to 13, 16, or 17" in **Pr.73** to add the voltage determined by the terminal 1 input when the main speed setting is input through terminal 2.
- When a negative voltage obtained from the addition, it is regarded as 0 and the operation is stopped when **Pr.73** = "0 to 3, 6, or 7", and the operation is reversed (polarity reversible operation) after the STF signal is turned ON when **Pr.73** = "10 to 13, 16, or 17".
- The terminal 1 compensation input can be added to the multi-speed setting or terminal 4 (initial value: 4 to 20 mA).

- The degree of addition to terminal 2 is adjustable with **Pr.242** and the degree of addition to terminal 4 is adjustable with **Pr.243**.

$$\text{Analog command value with use of terminal 2} = \text{terminal 2 input} + \text{terminal 1 input} \times \frac{\text{Pr.242}}{100(\%)}$$

$$\text{Analog command value with use of terminal 4} = \text{terminal 4 input} + \text{terminal 1 input} \times \frac{\text{Pr.243}}{100(\%)}$$

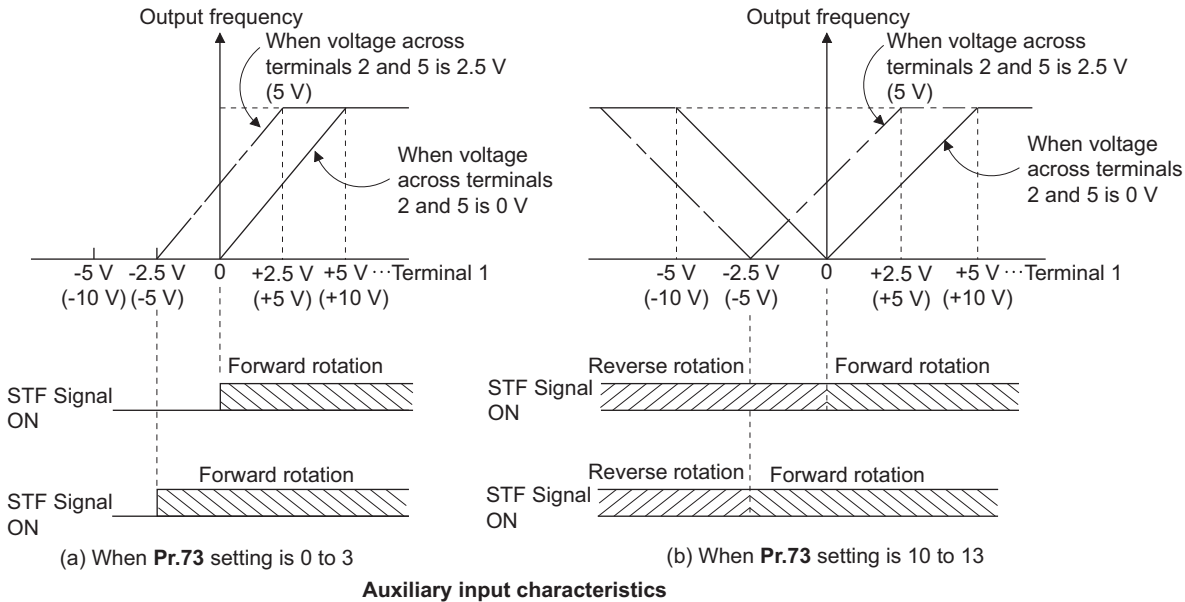

**NOTE**

- After changing the **Pr.73** setting, check the setting of the voltage/current input selection switch. Incorrect setting may cause a fault, failure, or malfunction. (Refer to [page 496](#) for the setting.)

**◆ Override function (Pr.252, Pr.253)**

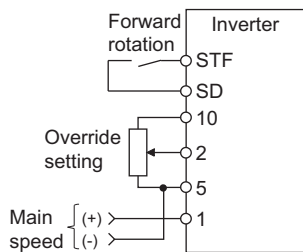

**Connection example for the override function**

- Use the override function to make the main speed changed at a specified rate.
- Set "4, 5, 14, or 15" in **Pr.73** to select the override function.
- When the override function is selected, terminal 1 or 4 is used for the main speed setting, and terminal 2 is used for the override signal. (If the main speed signal is not input through terminal 1 or 4, the compensation by terminal 2 is disabled.)
- Specify the scope of override by using **Pr.252** and **Pr.253**.
- How to calculate the set frequency when the override function is used:  
 Main speed setting frequency (Hz): Terminals 1 or 4 input, multi-speed setting  
 Compensation (%): Terminal 2 input

$$\text{Set frequency (Hz)} = \text{Main speed setting frequency (Hz)} \times \frac{\text{Compensation (\%)}}{100(\%)}$$

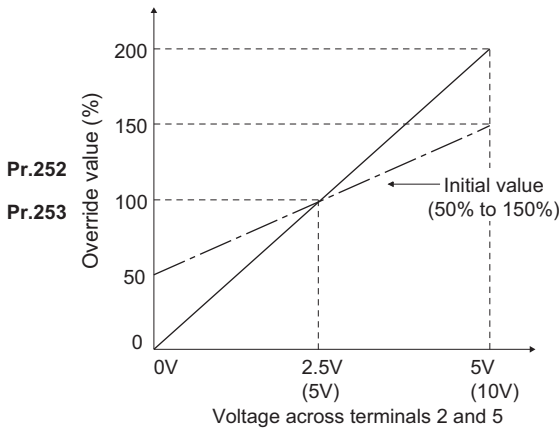

• Example) When **Pr.73** = "5"

By the terminal 1 (main speed) and terminal 2 (auxiliary) input, the setting frequency is set as shown in the figure below.

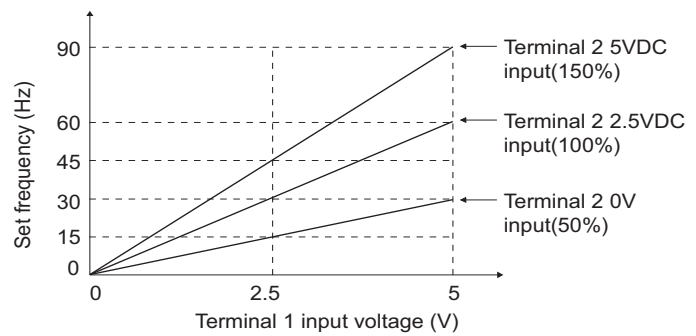

### NOTE

- To use terminal 4, the AU signal needs to be turned ON.
- To make compensation input for multi-speed operation or remote setting, set **Pr.28 Multi-speed input compensation selection** = "1" (with compensation) (initial value "0").
- After changing the **Pr.73** setting, check the setting of the voltage/current input selection switch. Incorrect setting may cause a fault, failure, or malfunction. (Refer to [page 496](#) for the setting.)

### Parameters referred to

**Pr.28 Multi-speed input compensation selection** [page 411](#)

**Pr.73 Analog input selection** [page 496](#)

## 5.12.4 Response level of analog input and noise elimination

The response level and stability of frequency command/torque command using the analog input signal (terminal 1, 2, or 4) can be adjusted.

Pr.	Name	Initial value	Setting range	Description
<b>74</b> <b>T002</b>	<b>Input filter time constant</b>	1	0 to 8	Set the primary delay filter time constant to the analog input command. If the setting is too large, response becomes slow.
<b>822</b> <b>T003</b>	<b>Speed setting filter 1</b>	9999	0 to 5 s 9999	Set the primary delay filter time constant to the external speed command (analog input command). As set in <b>Pr.74</b> .
<b>826</b> <b>T004</b>	<b>Torque setting filter 1</b>	9999	0 to 5 s 9999	Set the primary delay filter time constant to the external torque command (analog input command). As set in <b>Pr.74</b> .
<b>832</b> <b>T005</b>	<b>Speed setting filter 2</b>	9999	0 to 5 s, 9999	Second function of <b>Pr.822</b> (enabled when the RT signal is ON)
<b>836</b> <b>T006</b>	<b>Torque setting filter 2</b>	9999	0 to 5 s, 9999	Second function of <b>Pr.826</b> (enabled when the RT signal is ON)
<b>849</b> <b>T007</b>	<b>Analog input offset adjustment</b>	100%	0 to 200%	Set offset for the analog speed input (terminal 2). The motor is prevented from rotating due to noise in the analog input or other factors when a zero speed command is given.

## ◆ Block diagram

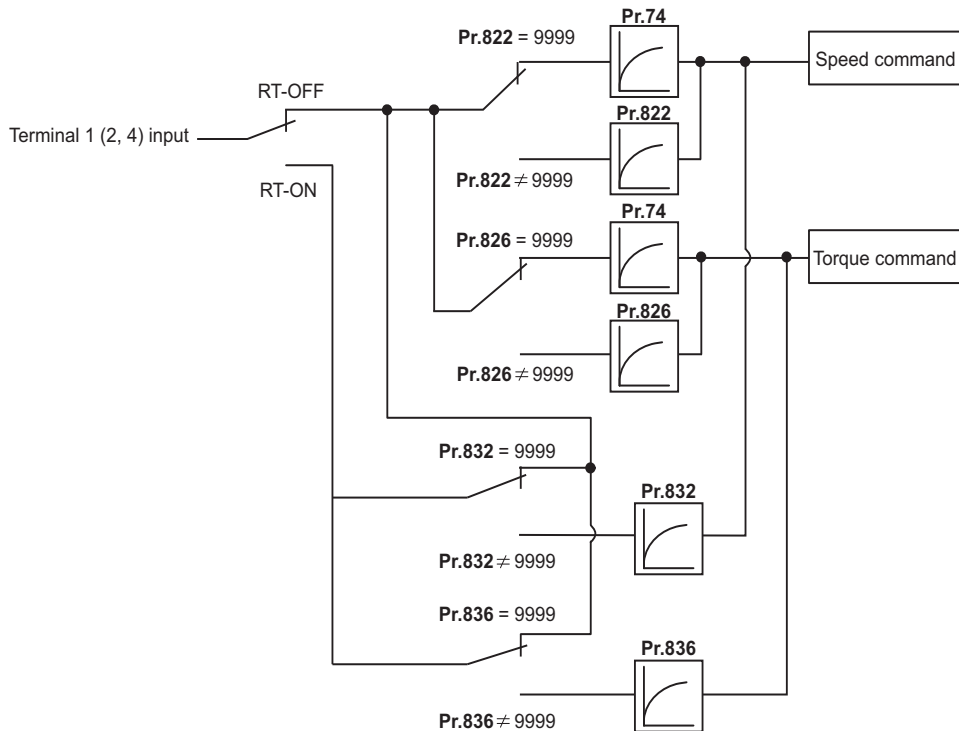

### ◆ Analog input time constant (Pr.74)

- Use this parameter to eliminate noise on the frequency setting circuit.
- Increase the filter time constant if the operation is unstable due to noise or other factors. If the setting is too large, response becomes slow. (The time constant can be between 0 and 8, which are about 2 ms to 1 second.)

### ◆ Analog speed command input time constant (Pr.822, Pr.832)

- Use **Pr.822 Speed setting filter 1** to set the primary delay filter time constant to the external speed command (analog input command). Increase the setting of the time constant to allow delays in follow-up of the speed command or when the analog input voltage is unstable.
- Use **Pr.832 Speed setting filter 2** to change the time constant to use one inverter to switch operation between two or more motors.
- **Pr.832 Speed setting filter 2** is enabled when the RT signal is ON.

### ◆ Analog torque command input time constant (Pr.826, Pr.836)

- Use **Pr.826 Torque setting filter 1** to set the primary delay filter time constant to the external torque command (analog input command). Increase the setting of the time constant to allow delays in follow-up of the torque command or when the analog input voltage is unstable.
- Use **Pr.836 Torque setting filter 2** to change the time constant to use one inverter to switch operation between two or more motors.
- **Pr.836 Torque setting filter 2** is enabled when the RT signal is ON.

### ◆ Analog speed command input offset adjustment (Pr.849)

- Use this parameter to set a range in which the motor is stopped for prevention of incorrect motor operation in a very low speed rotation when the speed command is an analog input.
- The voltage range is offset according to the setting in **Pr.849 Analog input offset adjustment**, assuming that 100% corresponds to zero.

100% < **Pr.849** ..... Positive side

100% > **Pr.849** ..... Negative side

The detailed calculation of the offset voltage is as described below:

$$\text{Offset voltage [V]} = \text{Voltage at the time of 100\% (5 V or 10 V}^{*1}) \times (\text{Pr.849} - 100) / 100$$

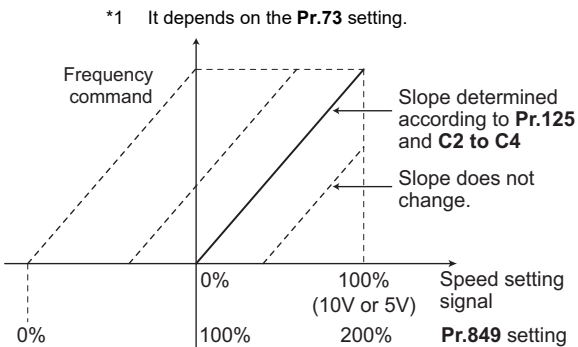

**NOTE**

- The analog input filter is invalid (no filter) during PID control operation.

Parameters referred to

Pr.73 Analog input selection [page 496](#)

Pr.125, C2 to C4 (bias and gain of the terminal 2 frequency setting) [page 505](#)

## 5.12.5 Frequency setting voltage (current) bias and gain

The magnitude (slope) of the output frequency can be set as desired in relation to the frequency setting signal (0 to 5 VDC, 0 to 10 VDC, or 4 to 20 mA). Use **Pr.73 Analog input selection (Pr.267 Terminal 4 input selection)** and the voltage/current input selection switch to switch among input of 0 to 5 VDC, 0 to 10 V, and 4 to 20 mA. (Refer to [page 496](#).)

Pr.	Name	Initial value		Setting range	Description	
		FM	CA			
C2 (902) T200 <sup>*1</sup>	Terminal 2 frequency setting bias frequency	0 Hz		0 to 590 Hz	Set the bias frequency for the terminal 2 input.	
C3 (902) T201 <sup>*1</sup>	Terminal 2 frequency setting bias	0%		0 to 300%	Set the converted % of the bias voltage (current) for the terminal 2 input.	
125 (903) T202 T022 <sup>*1</sup>	Terminal 2 frequency setting gain frequency	60 Hz	50 Hz	0 to 590 Hz	Set the gain (maximum) frequency for the terminal 2 input.	
C4 (903) T203 <sup>*1</sup>	Terminal 2 frequency setting gain	100%		0 to 300%	Set the converted % of the gain voltage (current) for the terminal 2 input.	
C5 (904) T400 <sup>*1</sup>	Terminal 4 frequency setting bias frequency	0 Hz		0 to 590 Hz	Set the bias frequency for the terminal 4 input.	
C6 (904) T401 <sup>*1</sup>	Terminal 4 frequency setting bias	20%		0 to 300%	Set the converted % of the bias current (voltage) for the terminal 4 input.	
126 (905) T402 T042 <sup>*1</sup>	Terminal 4 frequency setting gain frequency	60 Hz	50 Hz	0 to 590 Hz	Set the gain (maximum) frequency for the terminal 4 input.	
C7 (905) T403 <sup>*1</sup>	Terminal 4 frequency setting gain	100%		0 to 300%	Set the converted % of the gain current (voltage) for the terminal 4 input.	
C12 (917) T100 <sup>*1</sup>	Terminal 1 bias frequency (speed)	0 Hz		0 to 590 Hz	Set the bias frequency (speed) for the terminal 1 input. (Speed limit)	
C13 (917) T101 <sup>*1</sup>	Terminal 1 bias (speed)	0%		0 to 300%	Set the converted % of the bias voltage for the terminal 1 input. (Speed limit)	
C14 (918) T102 <sup>*1</sup>	Terminal 1 gain frequency (speed)	60 Hz	50 Hz	0 to 590 Hz	Set the gain (maximum) frequency (speed) for the terminal 1 input. (Speed limit)	
C15 (918) T103 <sup>*1</sup>	Terminal 1 gain (speed)	100%		0 to 300%	Set the converted % of the gain voltage for the terminal 1 input. (Speed limit)	
241 M043	Analog input display unit switchover	0		0 1	% display V/mA display	Select the unit for analog input display.

\*1 The parameter number in parentheses is the one for use with the LCD operation panel and the parameter unit.

## ◆ Relationship between the analog input terminal function and the calibration parameter

- Calibration parameter according to the terminal 1 function

Pr.868 setting	Terminal function	Calibration parameter	
		Bias setting	Gain setting
0 (initial value)	Auxiliary frequency (speed) setting	C2 (Pr.902) Terminal 2 frequency setting bias frequency, C3 (Pr.902) Terminal 2 frequency setting bias, C5 (Pr.904) Terminal 4 frequency setting bias frequency, C6 (Pr.904) Terminal 4 frequency setting bias	Pr.125 Terminal 2 frequency setting gain frequency, C4 (Pr.903) Terminal 2 frequency setting gain, Pr.126 Terminal 4 frequency setting gain frequency, C7 (Pr.905) Terminal 4 frequency setting gain
1	Magnetic flux command	C16 (Pr.919) Terminal 1 bias command (torque/magnetic flux), C17 (Pr.919) Terminal 1 bias (torque/magnetic flux)	C18 (Pr.920) Terminal 1 gain command (torque/magnetic flux), C19 (Pr.920) Terminal 1 gain (torque/magnetic flux)
2	Regenerative driving torque limit	C16 (Pr.919) Terminal 1 bias command (torque/magnetic flux), C17 (Pr.919) Terminal 1 bias (torque/magnetic flux)	C18 (Pr.920) Terminal 1 gain command (torque/magnetic flux), C19 (Pr.920) Terminal 1 gain (torque/magnetic flux)
3	Torque command		
4	Stall prevention operation level <sup>*1</sup> / torque limit / torque command		
5	Forward/reverse rotation speed limit	C12 (Pr.917) Terminal 1 bias frequency (speed), C13 (Pr.917) Terminal 1 bias (speed)	C14 (Pr.918) Terminal 1 gain frequency (speed), C15 (Pr.918) Terminal 1 gain (speed)
6	Torque bias input	C16 (Pr.919) Terminal 1 bias command (torque/magnetic flux), C17 (Pr.919) Terminal 1 bias (torque/magnetic flux)	C18 (Pr.920) Terminal 1 gain command (torque/magnetic flux), C19 (Pr.920) Terminal 1 gain (torque/magnetic flux)
9999	No function	—	—

- Calibration parameter according to the terminal 4 function

Pr.858 setting	Terminal function	Calibration parameter	
		Bias setting	Gain setting
0 (initial value)	Frequency command	C5 (Pr.904) Terminal 4 frequency setting bias frequency, C6 (Pr.904) Terminal 4 frequency setting bias	Pr.126 Terminal 4 frequency setting gain frequency, C7 (Pr.905) Terminal 4 frequency setting gain
1	Magnetic flux command	C38 (Pr.932) Terminal 4 bias command (torque/magnetic flux), C39 (Pr.932) Terminal 4 bias (torque/magnetic flux)	C40 (Pr.933) Terminal 4 gain command (torque/magnetic flux), C41 (Pr.933) Terminal 4 gain (torque/magnetic flux)
4	Stall prevention operation level <sup>*1</sup> / torque limit	C38 (Pr.932) Terminal 4 bias command (torque/magnetic flux), C39 (Pr.932) Terminal 4 bias (torque/magnetic flux)	C40 (Pr.933) Terminal 4 gain command (torque/magnetic flux), C41 (Pr.933) Terminal 4 gain (torque/magnetic flux)
9999	No function	—	—

\*1 Use Pr.148 Stall prevention level at 0 V input or Pr.149 Stall prevention level at 10 V input to adjust bias or gain for setting the stall prevention operation level.

## ◆ Changing the frequency for the maximum analog input (Pr.125, Pr.126)

- Use Pr.125 (Pr.126) to change the frequency setting (gain) for the maximum analog input voltage (current).  
(C2 (Pr.902) to C7 (Pr.905) settings do not need to be changed.)

## ◆ Analog input bias/gain calibration (C2 (Pr.902) to C7 (Pr.905), C12 (Pr.917) to C15 (Pr.918))

- The "bias" and "gain" functions serve to adjust the relationship between a setting input signal and the output frequency. A setting input signal is such as a 0 to 5 VDC, 0 to 10 VDC, or 4 to 20 mADC signal externally input to set the output frequency.
- Set the bias frequency of the terminal 2 input using C2 (Pr.902). (It is initially set to the frequency at 0 V.)
- Use Pr.125 to set the output frequency to the frequency command voltage (current) set by Pr.73 Analog input selection.

- Set the bias frequency of the terminal 1 input using **C12 (Pr.917)**. (It is initially set to the frequency at 0 V.)
- Set the gain frequency of the terminal 1 input using **C14 (Pr.918)**. (It is initially set to the frequency at 10 V.)
- Set the bias frequency of the terminal 4 input using **C5 (Pr.904)**. (It is initially set to the frequency at 4 mA.)
- Use **Pr.126** to set the output frequency to the 20 mA input of the frequency command current (4 to 20 mA).

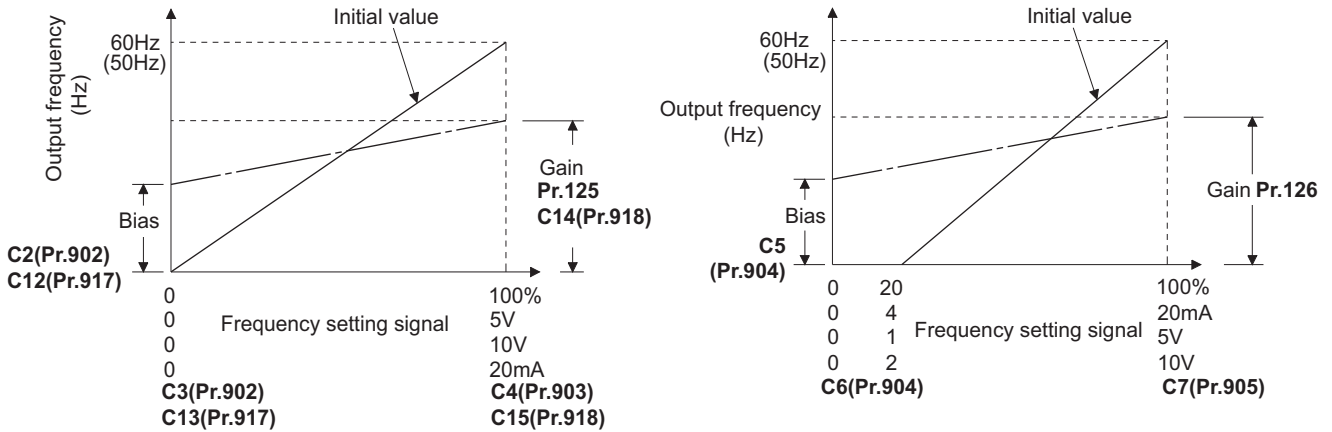

- There are three methods to adjust the bias/gain frequency setting voltage (current).  
Adjustment by applying voltage (current) between terminals 2 and 5 (4 and 5) to set the voltage (current) at the bias/gain frequency. [page 508](#)  
Adjustment by selecting the voltage (current) at the bias/gain frequency without applying voltage (current) between terminals 2 and 5 (4 and 5). [page 508](#)  
Adjustment by changing the frequency without adjusting the voltage (current). [page 510](#)

#### NOTE

- When the slope of the frequency is changed after calibration of terminal 2, the slope of the frequency is also changed for terminal 1.
- When voltage is applied to terminal 1 while calibration of terminal 2 or terminal 4 is in progress, the terminal 1 input value is added to the terminal 2 (4) input value.
- Always calibrate the input after changing the voltage/current input signal with **Pr.73 (Pr.267)** and the voltage/current input selection switch.

### ◆ Display unit changing for analog input (Pr.241)

- The analog input display unit (%V/mA) can be changed for analog input bias/gain calibration.
- Depending on the terminal input specification setting of **Pr.73 (Pr.267)** and the voltage/current input switch, the unit of the displayed value of **C3 (Pr.902)**, **C4 (Pr.903)**, **C6 (Pr.904)** and **C7 (Pr.905)** changes as shown below:

Analog command (via terminal 2 or 4) (depending on the settings of Pr.73 (Pr.267) and the voltage/current input selection switch)	Pr.241 = "0 (initial value)"	Pr.241 = "1"
0 to 5 V input	0 to 100% (0.1%)	0 to 5 V (0.01 V)
0 to 10 V input	0 to 100% (0.1%)	0 to 10 V (0.01 V)
0 to 20 mA input	0 to 100% (0.1%)	0 to 20 mA (0.01 mA)

#### NOTE











- When voltage is applied to terminal 1 while the terminal 1 input specification (0 to ±5 V, 0 to ±10 V) does not agree with the main speed (terminal 2 or terminal 4 input) specification (0 to 5 V, 0 to 10 V, 0 to 20 mA), the analog input is not correctly displayed. (For example, when 0 V is applied to terminal 2 and 10 V is applied to terminal 1 in the initial status, the value is indicated as 5 V (100%))  
Set "0 (initial value)" in **Pr.241** to use the % display.



## ◆ Frequency setting voltage (current) bias/gain adjustment method



### ■ Adjustment by applying voltage (current) between terminals 2 and 5 (4 and 5) to set the voltage (current) at the bias/gain frequency (Example of adjustment at the gain frequency)

#### Operating procedure



1. Turning ON the power of the inverter  
The operation panel is in the monitor mode.
2. Changing the operation mode  
Press  to choose the PU operation mode. The [PU] indicator turns ON.
3. Selecting the parameter setting mode  
Press  to choose the parameter setting mode. (The parameter number read previously appears.)
4. Calibration parameter selection  
Turn  until "┌ . . . " appears. Press  to display "┌ - - - -".
5. Selecting a parameter  
Turn  until "┌ 4┐ (C4 (Pr.903) Terminal 2 frequency setting gain) appears for terminal 2, or "┌ 7┐ (C7 (Pr.905) Terminal 4 frequency setting gain) for terminal 4.
6. Analog voltage (current) display  
Press  to display the analog voltage (current) value (%) currently applied to terminal 2 (4).  
Do not touch  until calibration is completed.
7. Voltage (current) application  
Apply a 5 V (20 mA). (Turn the external potentiometer connected between terminals 2 and 5 (terminals 4 and 5) to a desired position.)
8. Setting completed  
Press  to confirm the selection. The analog voltage (current) % and "┌ 4┐ (┌ 7┐)" are displayed alternately.
  - Turn  to read another parameter.
  - Press  to return to the "┌ - - - -" display.
  - Press  twice to show the next parameter.

### ■ Adjustment by selecting the voltage (current) at the bias/gain frequency without applying voltage (current) between terminals 2 and 5 (4 and 5) (Example of adjustment at the gain frequency)

#### Operating procedure

1. Turning ON the power of the inverter  
The operation panel is in the monitor mode.
2. Changing the operation mode  
Press  to choose the PU operation mode. The [PU] indicator turns ON.
3. Selecting the parameter setting mode  
Press  to choose the parameter setting mode. (The parameter number read previously appears.)

#### 4. Calibration parameter selection

Turn  until "E . . . ." appears. Press  to display "E - - - -".

#### 5. Selecting a parameter

Turn  until "E 4" (**C4 (Pr.903) Terminal 2 frequency setting gain**) appears for terminal 2, or "E 7" (**C7 (Pr.905) Terminal 4 frequency setting gain**) for terminal 4.

#### 6. Analog voltage (current) display

Press  to display the analog voltage (current) value (%) currently applied to terminal 2 (4).



#### 7. Analog voltage (current) adjustment

When  is turned, the gain voltage (current) value (%) currently set to the parameter appears.

Turn  until the desired gain voltage (current) value (%) appears.

#### 8. Setting completed

Press  to confirm the selection. The analog voltage (current) % and "E 4 (E 7)" are displayed alternately.

- Turn  to read another parameter.
- Press  to return to the "E - - - -" display.
- Press  twice to show the next parameter.

#### NOTE

- Press  after step 6 to check the present bias/gain frequency setting. The setting cannot be checked after step 7.

## ■ Adjustment by changing the frequency without adjusting the voltage (current) (Example of changing the gain frequency from 60 Hz to 50 Hz)

### Operating procedure

#### 1. Selecting the parameter

Turn  until "P. 125" (Pr.125) appears for terminal 2, or "P. 126" (Pr.126) for terminal 4.

Press  to read the present set value. (60.00 Hz)

#### 2. Changing the maximum frequency

Turn  to change the set value to "5000". (50.00 Hz)

Press  to confirm the selection. "5000" and "P. 125 (P. 126)" are displayed alternately.

#### 3. Selecting the mode and the monitor item

Press  three times to select the monitor mode, and change the monitor item to the frequency.

#### 4. Start

Turn ON the start switch (STF/STR signal), and turn the frequency setting potentiometer clockwise slowly to full. (Refer to steps 2 and 3 in [page 157](#).)

The motor is operated at 50 Hz.

### NOTE

- If the frequency meter (display meter) connected between terminal FM and SD (CA and 5) does not indicate exactly 60 Hz, set the calibration parameter **C0 FM/CA terminal calibration**. (Refer to [page 463](#).)
- If the voltage (current) values at the gain and bias frequencies are too close to each other, an error "Er 3" may be indicated.
- Changing **C4 (Pr.903)** or **C7 (Pr.905)** (gain adjustment) will not change **Pr.20**.  
Input to terminal 1 (frequency setting auxiliary input) is added to the frequency setting signal.
- For operation outline of the parameter unit (FR-PU07), refer to the Instruction Manual of the FR-PU07.
- To set the value to 120 Hz or higher, the **Pr.18 High speed maximum frequency** needs to be 120 Hz or higher. (Refer to [page 428](#).)
- Use the calibration parameter **C2 (Pr.902)** or **C5 (Pr.904)** to set the bias frequency. (Refer to [page 506](#).)

### CAUTION

- Be cautious when setting any value other than "0" as the bias frequency at 0 V (0 mA). Even if a speed command is not given, simply turning ON the start signal will start the motor at the preset frequency.

#### Parameters referred to

Pr.1 Maximum frequency, Pr.18 High speed maximum frequency [page 428](#)

Pr.20 Acceleration/deceleration reference frequency [page 367](#)

Pr.73 Analog input selection, Pr.267 Terminal 4 input selection [page 496](#)

Pr.79 Operation mode selection [page 389](#)

Pr.858 Terminal 4 function assignment, Pr.868 Terminal 1 function assignment [page 500](#)

## 5.12.6 Torque (magnetic flux) setting voltage (current) bias and gain

The magnitude (slope) of the torque can be set as desired in relation to the torque setting signal (0 to 5 VDC, 0 to 10 VDC, or 4 to 20 mA).

Use **Pr.73 Analog input selection** or **Pr.267 Terminal 4 input selection** to switch among input 0 to 5 VDC, 0 to 10 V, and 4 to 20 mA. (Refer to [page 496](#).)

Pr.	Name	Initial value	Setting range	Description	
<b>C16 (919)</b> <b>T110<sup>*1</sup></b>	<b>Terminal 1 bias command (torque/magnetic flux)</b>	0%	0 to 400%	Set the bias torque (magnetic flux) for the terminal 1 input.	
<b>C17 (919)</b> <b>T111<sup>*1</sup></b>	<b>Terminal 1 bias (torque/magnetic flux)</b>	0%	0 to 300%	Set the converted % of the bias voltage for the terminal 1 input.	
<b>C18 (920)</b> <b>T112<sup>*1</sup></b>	<b>Terminal 1 gain command (torque/magnetic flux)</b>	150%	0 to 400%	Set the gain (maximum) torque (magnetic flux) for the terminal 1 input.	
<b>C19 (920)</b> <b>T113<sup>*1</sup></b>	<b>Terminal 1 gain (torque/magnetic flux)</b>	100%	0 to 300%	Set the converted % of the gain voltage for the terminal 1 input.	
<b>C38 (932)</b> <b>T410<sup>*1</sup></b>	<b>Terminal 4 bias command (torque/magnetic flux)</b>	0%	0 to 400%	Set the bias torque (magnetic flux) for the terminal 4 input.	
<b>C39 (932)</b> <b>T411<sup>*1</sup></b>	<b>Terminal 4 bias (torque/magnetic flux)</b>	20%	0 to 300%	Set the converted % of the bias current (voltage) for the terminal 4 input.	
<b>C40 (933)</b> <b>T412<sup>*1</sup></b>	<b>Terminal 4 gain command (torque/magnetic flux)</b>	150%	0 to 400%	Set the gain (maximum) torque (magnetic flux) for the terminal 4 input.	
<b>C41 (933)</b> <b>T413<sup>*1</sup></b>	<b>Terminal 4 gain (torque/magnetic flux)</b>	100%	0 to 300%	Set the converted % of the gain current (voltage) for the terminal 4 input.	
<b>241</b> <b>M043</b>	<b>Analog input display unit switchover</b>	0	0	% display	Select the unit for analog input display.
			1	V/mA display	

\*1 The parameter number in parentheses is the one for use with the LCD operation panel and the parameter unit.

## ◆ Changing the function of analog input terminal

- In the initial setting, terminal 1 is used for analog input of the auxiliary speed setting (auxiliary speed limit), and terminal 4 is used for the speed command (speed limit). To use the analog input terminal to input the torque command, torque limit, or magnetic flux command, set **Pr.868 Terminal 1 function assignment** or **Pr.858 Terminal 4 function assignment** to change the function. (Refer to [page 500](#).) The magnetic flux command is valid under Vector control only.

## ◆ Relationship between the analog input terminal function and the calibration parameter

- Calibration parameter according to the terminal 1 function

Pr.868 setting	Terminal function	Calibration parameter	
		Bias setting	Gain setting
0 (initial value)	Auxiliary Frequency (speed) setting	C2 (Pr.902) Terminal 2 frequency setting bias frequency, C3 (Pr.902) Terminal 2 frequency setting bias, C5 (Pr.904) Terminal 4 frequency setting bias frequency, C6 (Pr.904) Terminal 4 frequency setting bias	Pr.125 Terminal 2 frequency setting gain frequency, C4 (Pr.903) Terminal 2 frequency setting gain, Pr.126 Terminal 4 frequency setting gain frequency, C7 (Pr.905) Terminal 4 frequency setting gain
1	Magnetic flux command	C16 (Pr.919) Terminal 1 bias command (torque/magnetic flux), C17 (Pr.919) Terminal 1 bias (torque/magnetic flux)	C18 (Pr.920) Terminal 1 gain command (torque/magnetic flux), C19 (Pr.920) Terminal 1 gain (torque/magnetic flux)
2	Regenerative driving torque limit	C16 (Pr.919) Terminal 1 bias command (torque/magnetic flux), C17 (Pr.919) Terminal 1 bias (torque/magnetic flux)	C18 (Pr.920) Terminal 1 gain command (torque/magnetic flux), C19 (Pr.920) Terminal 1 gain (torque/magnetic flux)
3	Torque command		
4	Stall prevention operation level <sup>*1</sup> / torque limit / torque command		
5	Forward/reverse rotation speed limit	C12 (Pr.917) Terminal 1 bias frequency (speed), C13 (Pr.917) Terminal 1 bias (speed)	C14 (Pr.918) Terminal 1 gain frequency (speed), C15 (Pr.918) Terminal 1 gain (speed)
6	Torque bias input	C16 (Pr.919) Terminal 1 bias command (torque/magnetic flux), C17 (Pr.919) Terminal 1 bias (torque/magnetic flux)	C18 (Pr.920) Terminal 1 gain command (torque/magnetic flux), C19 (Pr.920) Terminal 1 gain (torque/magnetic flux)
9999	No function	—	—

\*1 Use Pr.148 Stall prevention level at 0 V input and Pr.149 Stall prevention level at 10 V input to adjust bias and gain for setting the stall prevention operation level.

- Calibration parameter according to the terminal 4 function

Pr.858 setting	Terminal function	Calibration parameter	
		Bias setting	Gain setting
0 (initial value)	Frequency (speed) command / speed limit	C5 (Pr.904) Terminal 4 frequency setting bias frequency, C6 (Pr.904) Terminal 4 frequency setting bias	Pr.126 Terminal 4 frequency setting gain frequency, C7 (Pr.905) Terminal 4 frequency setting gain
1	Magnetic flux command	C38 (Pr.932) Terminal 4 bias command (torque/magnetic flux), C39 (Pr.932) Terminal 4 bias (torque/magnetic flux)	C40 (Pr.933) Terminal 4 gain command (torque/magnetic flux), C41 (Pr.933) Terminal 4 gain (torque/magnetic flux)
4	Stall prevention operation level <sup>*2</sup> / torque limit	C38 (Pr.932) Terminal 4 bias command (torque/magnetic flux), C39 (Pr.932) Terminal 4 bias (torque/magnetic flux)	C40 (Pr.933) Terminal 4 gain command (torque/magnetic flux), C41 (Pr.933) Terminal 4 gain (torque/magnetic flux)
9999	No function	—	—

\*2 Use Pr.148 Stall prevention level at 0 V input and Pr.149 Stall prevention level at 10 V input to adjust bias and gain for setting the stall prevention operation level.

## ◆ Changing the torque for the maximum analog input (C18 (Pr.920), C40 (Pr.933))

- Use C18 (Pr.920) or C40 (Pr.933) to change the torque setting (gain) for the maximum analog input voltage (current).

## ◆ Analog input bias/gain calibration (C16 (Pr.919) to C19 (Pr.920), C38 (Pr.932) to C41 (Pr.933))

- The "bias" and "gain" functions serve to adjust the relationship between a setting input signal and the torque. A setting input signal is such as a 0 to 5 VDC, 0 to 10 VDC, or 4 to 20 mADC signal externally input to set the torque command or the torque limit.
- Set the bias torque of the terminal 1 input using C16 (Pr.919). (The initial value is the torque for 0 V.)

- Use **C18 (Pr.920)** to set the torque to the torque command voltage set by **Pr.73 Analog input selection**. (The initial value is 10 V.)
- Set the bias torque of the terminal 4 input using **C38 (Pr.932)**. (The initial value is the torque for 4 mA.)
- Use **C40 (Pr.933)** to set the torque to the 20 mA input of the torque command current (4 to 20 mA).

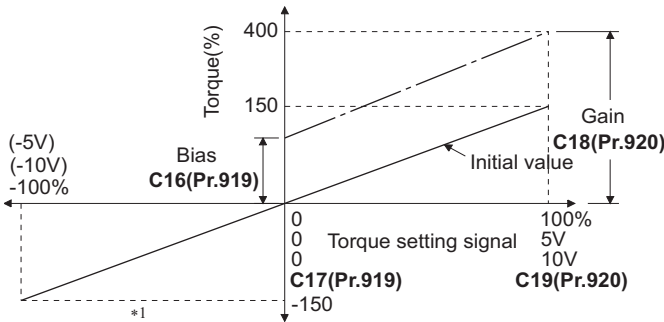

Calibration example of terminal 1

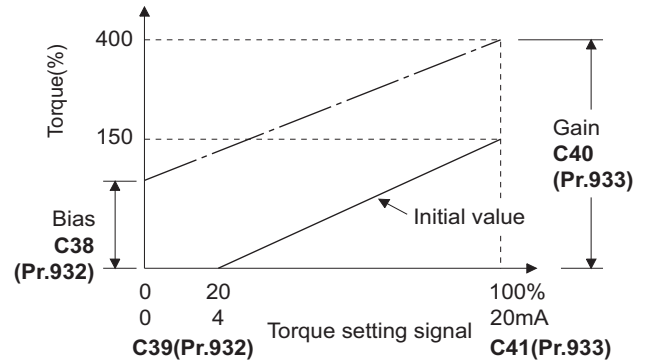

Calibration example of terminal 4

\*1 A negative voltage (0 to -10 V (-5 V)) is valid as a torque command. However, when a negative voltage is input as a torque limit value, the torque limit is regarded as "0".

- There are three methods to adjust the bias/gain torque setting voltage (current).  
Adjustment by applying voltage (current) between terminals 1 and 5 (4 and 5) to set the voltage (current) at the bias/gain level. [page 513](#)  
Adjustment by selecting the voltage (current) at the bias/gain level without applying voltage (current) between terminals 1 and 5 (4 and 5). [page 515](#)  
Adjustment by changing the torque without adjusting the voltage (current). [page 516](#)

### NOTE

- Always calibrate the input after changing the voltage/current input signal with **Pr.73 (Pr.267)** and the voltage/current input selection switch.

## ◆ Display unit changing for analog input (Pr.241)

- The analog input display unit (%/V/mA) can be changed for analog input bias/gain calibration.
- Depending on the terminal input specification setting of **Pr.73 (Pr.267)**, the unit of the displayed value of **C17 (Pr.919)**, **C19 (Pr.920)**, **C39 (Pr.932)**, and **C41 (Pr.933)** changes as shown below:

Analog command (via terminal 1 or 4) (depending on the settings of Pr.73 (Pr.267))	Pr.241 = "0" (initial value)	Pr.241 = "1"
0 to 5 V input	0 to 100% (0.1%)	0 to 5 V (0.01 V)
0 to 10 V input	0 to 100% (0.1%)	0 to 10 V (0.01 V)
0 to 20 mA input	0 to 100% (0.1%)	0 to 20 mA (0.01 mA)



## ◆ Torque setting voltage (current) bias/gain adjustment method

### ■ Adjustment by applying voltage (current) between terminals 1 and 5 (4 and 5) to set the voltage (current) at the bias/gain torque

#### Operating procedure

1. Turning ON the power of the inverter  
The operation panel is in the monitor mode.
2. Changing the operation mode  
Press  to choose the PU operation mode. [PU] indicator turns ON.
3. Selecting the parameter setting mode  
Press  to choose the parameter setting mode. (The parameter number read previously appears)

#### 4. Calibration parameter selection

Turn  until "C. . . ." appears. Press  to display "C - - - -".

#### 5. Selecting a parameter

Turn  until "C 19" (C19 (Pr.920) Terminal 1 gain (torque/magnetic flux)) appears for terminal 1, or "C 4 1" (C41 (Pr.933) Terminal 4 gain (torque/magnetic flux)) for terminal 4.

#### 6. Analog voltage (current) display

Press  to display the analog voltage (current) % currently applied to the terminal 1 (4).



Do not touch  until calibration is completed.

#### 7. Voltage (current) application

Apply a 5 V (20 mA). (Turn the external potentiometer connected between terminals 1 and 5 (terminals 4 and 5) to a desired position.)







#### 8. Setting completed

Press  to confirm the selection. The analog voltage (current) % and "C 19" ("C 4 1") are displayed alternately.

- Turn  to read another parameter.
- Press  to return to the "C - - - -" display.
- Press  twice to show the next parameter.

## ■ Adjustment by selecting the voltage (current) at the bias/gain torque without applying voltage (current) between terminals 1 and 5 (4 and 5)

### Operating procedure

1. Turning ON the power of the inverter  
The operation panel is in the monitor mode.
2. Changing the operation mode  
Press  to choose the PU operation mode. [PU] indicator turns ON.
3. Selecting the parameter setting mode  
Press  to choose the parameter setting mode. (The parameter number read previously appears)
4. Calibration parameter selection  
Turn  until "┌ . . . ." appears. Press  to display "┌ - - - -".
5. Selecting a parameter  
Turn  until "┌ 19" (C19 (Pr.920) Terminal 1 gain (torque/magnetic flux)) appears for terminal 1, or "┌ 41" (C41 (Pr.933) Terminal 4 gain (torque/magnetic flux)) for terminal 4.
6. Analog voltage (current) display  
Press  to display the analog voltage (current) % currently applied to the terminal 1 (4).
7. Analog voltage (current) adjustment  
When  is turned, the gain voltage (current) value (%) currently set to the parameter appears.  
Turn  until the desired gain voltage (current) value (%) appears.
8. Setting completed  
Press  to confirm the selection. The analog voltage (current) % and "┌ 19" ("┌ 41") are displayed alternately.
  - Turn  to read another parameter.
  - Press  to return to the "┌ - - - -" display.
  - Press  twice to show the next parameter.

### NOTE

- Press  after step 6 to check the present bias/gain torque setting. The setting cannot be checked after step 7.



## ■ Adjustment by changing the torque without adjusting the voltage (current) (Example of changing the gain torque from 150% to 130%)

### Operating procedure

#### 1. Selecting the parameter

Turn  until "C 18" (Pr.920) appears for terminal 1, or "C 40" (Pr.933) for terminal 4.

Press  to read the present set value. (150.0%)

#### 2. Torque setting change

Turn  to change the set value to "13000" (130.0%)

Press  to confirm the selection. "13000" and "C 18" ("C 40") are displayed alternately.

#### 3. Selecting the mode and the monitor item

Press  three times to select the monitor mode, and change the monitor item to the frequency.

#### 4. Start

Turn ON the start switch (STF or STR) to apply a voltage across terminals 1 and 5 (4 and 5),  
Operation is performed with 130% torque.

### NOTE

- If the voltage (current) values at the gain and bias torques are too close to each other, an error ("Er 3") may be indicated.
- For operation outline of the parameter unit (FR-PU07), refer to the Instruction Manual of the FR-PU07.
- Use the calibration parameter **C16 (Pr.919)** or **C38 (Pr.932)** to set the bias torque. (Refer to [page 512.](#))

### CAUTION

- Be cautious when setting any value other than "0" as the bias torque at 0 V (0 mA). Even if a torque command is not given, simply turning ON the start signal will supply torque to the motor.

#### Parameters referred to

Pr.20 Acceleration/deceleration reference frequency [page 367](#)

Pr.73 Analog input selection, Pr.267 Terminal 4 input selection [page 496](#)

Pr.79 Operation mode selection [page 389](#)

Pr.858 Terminal 4 function assignment, Pr.868 Terminal 1 function assignment [page 500](#)

## 5.12.7 Checking of current input on analog input terminal

When current is input to the analog input terminal 2 or terminal 4, the input current can be checked and the operation when the input falls below the specified level (the analog current input is lost) can be selected. The operation can be continued even when the analog current input is lost.

Pr.	Name	Initial value	Setting range	Description			
573 T052	4 mA input check selection	9999	1	Operation continues with output frequency before the current input loss.	Check the current input on terminals 2 and 4.		
			2	4 mA input fault (E.LCI) is activated when the current input loss is detected.			
			3	The inverter output decelerates the motor to a stop when the current input loss is detected. After the motor is stopped, 4 mA input fault (E.LCI) is activated.			
			4	Operation continues at the frequency set in <b>Pr.777</b> .			
			11	Operation continues at the output frequency before the current input loss.	Check the current input on terminal 4.		
			12	4 mA input fault (E.LCI) is activated when the current input loss is detected.			
			13	The inverter output decelerates the motor to a stop when the current input loss is detected. After the motor is stopped, 4 mA input fault (E.LCI) is activated.			
			14	Operation continues at the frequency set in <b>Pr.777</b> .			
			21	Operation continues at the output frequency before the current input loss.	Check the current input on terminal 2.		
			22	4 mA input fault (E.LCI) is activated when the current input loss is detected.			
			23	The inverter output decelerates the motor to a stop when the current input loss is detected. After the motor is stopped, 4 mA input fault (E.LCI) is activated.			
			24	Operation continues at the frequency set in <b>Pr.777</b> .			
			9999	No current input check			
			777 T053 A681	4 mA input fault operation frequency	9999	0 to 590 Hz	Set the frequency to continue operation when current input is lost. (Valid when <b>Pr.573</b> = "4")
			9999	No current input check when <b>Pr.573</b> = "4"			
778 T054 A682	4 mA input check filter	0 s	0 to 10 s	Set the current input loss detection time.			

### ◆ Analog current input loss condition (Pr.778)

- When the current input to terminal 4 (terminal 2) continues to be 2 mA or less for the period set in **Pr.778**, it is considered as loss of analog current input and the Alarm (LF) signal is turned ON. The LF signal turns OFF when the current input becomes 3 mA or higher.
- For the LF signal, set "98 (positive logic) or 198 (negative logic)" in any of **Pr.190 to Pr.196 (Output terminal function selection)** to assign the function to the output terminal.

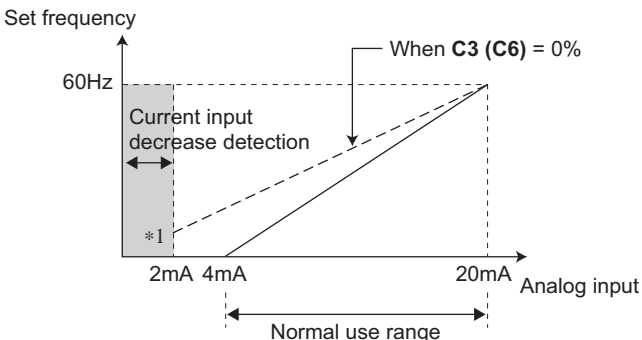

\*1 When Pr.573 ≠ "9999" and the terminal 4 (terminal 2) input is calibrated to 2 mA or less in C2 (Pr.902) (C5 (Pr.904)), the operation set in Pr.573 is applied to the frequency at the input of 2 mA or less.

**NOTE**

- Changing the terminal assignment using Pr.190 to Pr.196 (Output terminal function selection) may affect the other functions. Set parameters after confirming the function of each terminal.

**◆ Continuing operation when the analog current input is lost (Pr.573 = "1, 4, 11, 14, 21, or 24", and Pr.777)**

- When Pr.573 = "1, 11, or 21", operation continues at the output frequency before the current input loss.
- When Pr.573 = "4, 14, or 24" and Pr.777 ≠ "9999", operation continues at the frequency set in Pr.777.
- When the start command is turned OFF during current input loss, the inverter output decelerates the motor to a stop immediately, and the operation is not restarted even if a start command is input again.
- When the current input is restored, the LF signal is turned OFF, and operation is performed according to the current input.
- The following is the operation example during External operation.

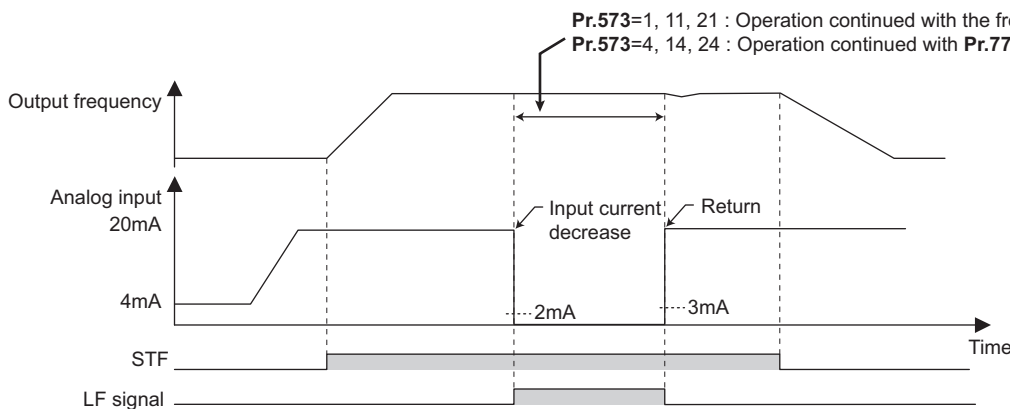

- The following is the operation example during PID control (reverse action) operation.

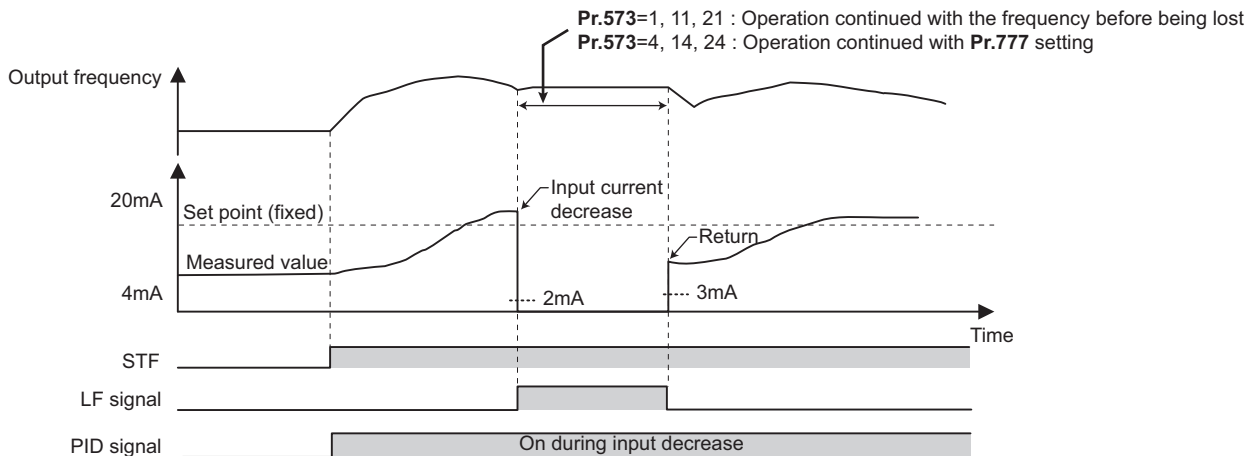

**NOTE**

- When the setting is changed to the continuous operation (Pr.573 = "1, 4, 11, 14, 21, or 24") after the input current loss, the frequency before loss is regarded as 0 Hz.

**◆ Fault output (Pr.573 = "2, 12, or 22")**

- When the analog current input becomes 2 mA or lower, the protective function E.LCI (4 mA input fault) is activated and the output is shut off.

- The following is the operation example during PID control (reverse action) operation.

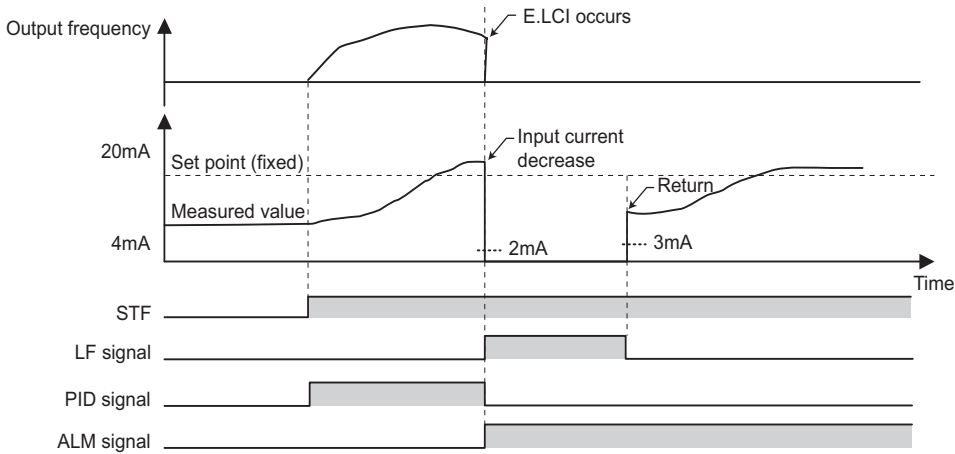

◆ **Fault output after deceleration to stop (Pr.573 = "3, 13, or 23")**

- When the analog current input becomes 2 mA or lower, the inverter output decelerates the motor to a stop, and then the protective function E.LCI (4 mA input fault) is activated and the output is shut off.
- When the analog current input is restored during the deceleration, the motor is accelerated again and operates according to the current input.
- The following is the operation example during PID control (reverse action) operation.

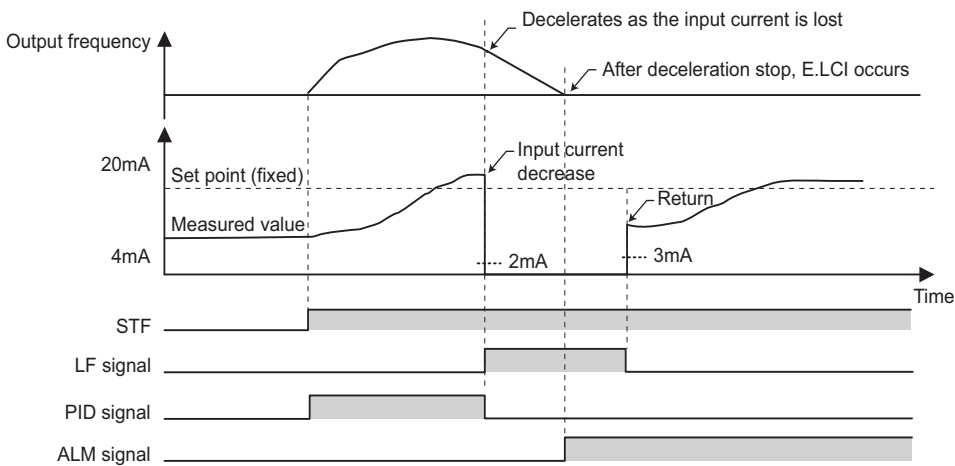

- The following is the operation example when the analog input current is restored during deceleration under PID control (reverse action).

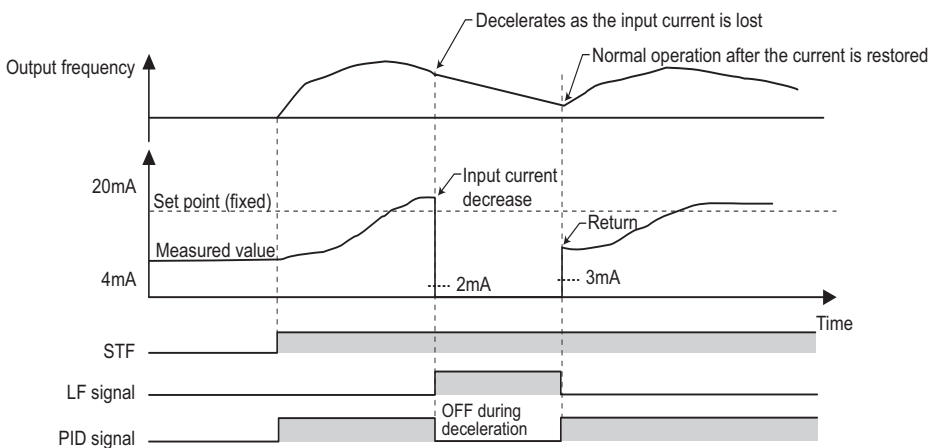

## ◆ Functions related to current input check

Function	Operation	Refer to page
Minimum frequency	When the operation continues, the minimum frequency setting is valid even during current input loss.	428
Multi-speed operation	The multi-speed setting signal is prioritized even during current input loss (the motor operates according to the multi-speed setting even during continuous operation at the predetermined frequency or during deceleration to a stop). When the multi-speed setting signal is turned OFF while the input current is lost during the multi-speed operation, the motor is decelerated to a stop even if the parameter is set to continue operation when the current input is lost.	411
JOG operation	JOG operation is prioritized even during current input loss (the motor operation switches to JOB operation even during continuous operation at the predetermined frequency or during deceleration to a stop). When the JOG signal is turned OFF while the input current is lost during the JOG operation, the motor is decelerated to a stop even if the parameter is set to continue operation when the current input is lost.	410
MRS signal	The MRS signal is enabled even during current input loss (output is shut off by turning ON the MRS signal even during continuous operation at the predetermined frequency or during deceleration to a stop).	524
Remote setting	When the operation using the remote setting function is changed to the continuous operation after the current input is lost, acceleration, deceleration, and clear operations by the remote setting are disabled. The operations are enabled after restoration of current input.	377
Retry function	When the protective function is activated during continuous operation after the current input is lost and the retry function is used successfully, operation continues without clearing the frequency setting.	426
Compensation by addition, override compensation	When the operation using compensation by addition or override compensation is changed to the continuous operation after the current input is lost, compensation by addition or override compensation is disabled. The operations are enabled after restoration of current input.	501
Input filter time constant	The current before the filter time is applied is used for input loss detection. The current after the filter time is applied is used for continuous operation at the output frequency before the input loss.	517
PID control	PID calculation is stopped during current input loss. However, PID control is not disabled (the operation does not return to normal). During the pre-charge, end determination or fault determination by the pre-charge function is not performed when the current input is lost. The sleep function is prioritized even during current input loss. When the clearing condition of the sleep function is met during current input loss, continuous operation at the predetermined frequency is restored.	601
Power failure stop	The power failure stop function is prioritized even if current input loss is detected during power failure. After the power failure stop and re-acceleration, operation continues at the output frequency before the input loss. When the protective function E.LCI is selected when the current input is lost, E.LCI is activated after the power failure stop.	642
Traverse function	Traverse operation is performed based on the frequency even during continuous operation during current input loss.	582

### Parameters referred to

Pr.73 Analog input selection, Pr.267 Terminal 4 input selection  page 496

## 5.12.8 Input terminal function selection

Use the following parameters to select or change the input terminal functions.

Pr.	Name	Initial value	Initial signal	Setting range
178 T700	STF terminal function selection	60	STF (Forward rotation command)	0 to 20, 22 to 28, 32, 37, 42 to 48, 50 to 53, 57 to 60, 62, 64 to 74, 76, 77 to 80, 85, 87 to 89, 92 to 96, 128, 129, 9999
179 T701	STR terminal function selection	61	STR (Reverse rotation command)	0 to 20, 22 to 28, 32, 37, 42 to 48, 50 to 53, 57 to 59, 61, 62, 64 to 74, 76, 77 to 80, 85, 87 to 89, 92 to 96, 128, 129, 9999
180 T702	RL terminal function selection	0	RL (Low-speed operation command)	0 to 20, 22 to 28, 32, 37, 42 to 48, 50 to 53, 57 to 59, 62, 64 to 74, 76, 77 to 80, 85, 87 to 89, 92 to 96, 128, 129, 9999
181 T703	RM terminal function selection	1	RM (Middle-speed operation command)	
182 T704	RH terminal function selection	2	RH (High-speed operation command)	
183 T705	RT terminal function selection	3	RT (Second function selection)	
184 T706	AU terminal function selection	4	AU (Terminal 4 input selection)	
185 T707	JOG terminal function selection	5	JOG (Jog operation selection)	
186 T708	CS terminal function selection	6	CS (Selection of automatic restart after instantaneous power failure / flying start)	
187 T709	MRS terminal function selection	24 <sup>*1</sup> 10 <sup>*2</sup>	MRS (Output stop) X10 (Inverter run enable)	
188 T710	STOP terminal function selection	25	STP (STOP) (Start self-holding selection)	
189 T711	RES terminal function selection	62	RES (Inverter reset)	

Pr.	Name	Initial value	Setting range	Description
699 T740	Input terminal filter	9999	5 to 50 ms 9999	Set the time delay for the input terminal response. No filter for the input terminal

\*1 The initial value is for standard models and IP55 compatible models.

\*2 The initial value is for separated converter types.

### ◆ Input terminal function assignment

- Use **Pr.178 to Pr.189** to set the functions of the input terminals.
- Refer to the following table and set the parameters.

Setting	Signal name	Function	Related parameter	Refer to page	
0	RL	Pr.59 = 0 (initial value)	Low-speed operation command	Pr.4 to Pr.6, Pr.24 to Pr.27, Pr.232 to Pr.239	411
		Pr.59 ≠ 0 <sup>*1</sup>	Remote setting (setting clear)	Pr.59	377
		Pr.270 = "1, 3, 11, 13" <sup>*2</sup>	Stop-on-contact selection 0	Pr.270, Pr.275, Pr.276	577
1	RM	Pr.59 = 0 (initial value)	Middle-speed operation command	Pr.4 to Pr.6, Pr.24 to Pr.27, Pr.232 to Pr.239	411
		Pr.59 ≠ 0 <sup>*1</sup>	Remote setting (deceleration)	Pr.59	377
2	RH	Pr.59 = 0 (initial value)	High-speed operation command	Pr.4 to Pr.6, Pr.24 to Pr.27, Pr.232 to Pr.239	411
		Pr.59 ≠ 0 <sup>*1</sup>	Remote setting (acceleration)	Pr.59	377
3	RT	Second function selection		Pr.44 to Pr.51, Pr.450 to Pr.463, Pr.569, Pr.832, Pr.836, etc.	525
		Pr.270 = "1, 3, 11, 13" <sup>*2</sup>	Stop-on-contact selection 1	Pr.270, Pr.275, Pr.276	577
4	AU	Terminal 4 input selection		Pr.267	496
5	JOG	Jog operation selection		Pr.15, Pr.16	410

Setting	Signal name	Function	Related parameter	Refer to page
6	CS	Selection of automatic restart after instantaneous power failure / flying start	Pr.57, Pr.58, Pr.162 to Pr.165, Pr.299, Pr.611	628, 635
		Electronic bypass function	Pr.57, Pr.58, Pr.135 to Pr.139, Pr.159	563
7	OH	External thermal relay input <sup>*3</sup>	Pr.9	415
8	REX	15-speed selection (Combination with multi-speeds of RL, RM, and RH)	Pr.4 to Pr.6, Pr.24 to Pr.27, Pr.232 to Pr.239	411
9	X9	Third function selection	Pr.110 to Pr.116	525
10	X10	Inverter run enable (FR-HC2/FR-XC/FR-CV/FR-CC2 connection)	Pr.30, Pr.70, Pr.599	724
11	X11	FR-HC2/FR-CC2 connection, instantaneous power failure detection	Pr.30, Pr.70	724
12	X12	PU operation external interlock	Pr.79	389
13	X13	External DC injection brake operation start	Pr.10 to Pr.12	715
14	X14	PID control valid	Pr.127 to Pr.134, Pr.575 to Pr.577	601
15	BRI	Brake opening completion	Pr.278 to Pr.285	572
16	X16	PU/External operation switchover (External operation with X16-ON)	Pr.79, Pr.340	389
17	X17	Load pattern selection forward/reverse rotation boost (For constant-torque with X17-ON)	Pr.14	708
18	X18	V/F switchover (V/F control with X18-ON)	Pr.80, Pr.81, Pr.800	221
19	X19	Load torque high-speed frequency	Pr.270 to Pr.274	580
20	X20	S-pattern acceleration/deceleration C switchover	Pr.380 to Pr.383	372
22	X22	Orientation command (for Vector control compatible options) <sup>*4*6</sup>	Pr.350 to Pr.369	585
23	LX	Pre-excitation/servo ON <sup>*5</sup>	Pr.850	715
24	MRS	Output stop	Pr.17	524
		Electronic bypass function	Pr.57, Pr.58, Pr.135 to Pr.139, Pr.159	563
25	STP (STOP)	Start self-holding selection	Pr.250	722
26	MC	Control mode switchover	Pr.800	221
27	TL	Torque limit selection	Pr.815	245
28	X28	Start-time tuning start external input	Pr.95	558
32	X32	External fault input	—	525
37	X37	Traverse function selection	Pr.592 to Pr.597	582
42	X42	Torque bias selection 1	Pr.840 to Pr.845	265
43	X43	Torque bias selection 2	Pr.840 to Pr.845	265
44	X44	P/PI control switchover (P control with X44-ON)	Pr.820, Pr.821, Pr.830, Pr.831	254
45	BRI2	Second brake sequence open completion	Pr.641 to Pr.648	572
46	TRG	Trace trigger input	Pr.1020 to Pr.1047	649
47	TRC	Trace sampling start/end	Pr.1020 to Pr.1047	649
48	X48	Power failure stop external	Pr.261 to Pr.266, Pr.294, Pr.668	642
50	SQ	Sequence start	Pr.414	646
51	X51	Fault clear	Pr.414	646
52	X52	Cumulative pulse monitor clear (for Vector control compatible plug-in options)	Pr.635	321
53	X53	Cumulative pulse monitor clear (control terminal option) (for FR-A8TP)		
57	JOGF	JOG forward rotation command	Pr.15, Pr.16	410
58	JOGR	JOG reverse rotation command	Pr.15, Pr.16	410
59	CLRN	NET position pulse clear	Pr.291, Pr.419 to Pr.430, Pr.464	320
60	STF	Forward rotation command (assignable to the STF terminal (Pr.178) only)	Pr.250	722
61	STR	Reverse rotation command (assignable to the STR terminal (Pr.179) only)	Pr.250	722
62	RES	Inverter reset	Pr.75	336
64	X64	PID forward/reverse action switchover	Pr.127 to Pr.134	601
65	X65	PU/NET operation switchover (PU operation with X65-ON)	Pr.79, Pr.340	389

Setting	Signal name	Function	Related parameter	Refer to page
66	X66	External/NET operation switchover (NET operation with X66-ON)	Pr.79, Pr.340	389
67	X67	Command source switchover (command by Pr.338 or Pr.339 enabled with X67-ON)	Pr.338, Pr.339	400
68	NP	Simple position pulse train sign	Pr.291, Pr.419 to Pr.430, Pr.464	320
69	CLR	Simple position droop pulse clear	Pr.291, Pr.419 to Pr.430, Pr.464	320
70	X70	DC feeding operation permission <sup>*7</sup>	Pr.30	724
71	X71	DC feeding cancel <sup>*7</sup>	Pr.30	724
72	X72	PID P control switchover	Pr.127 to Pr.134, Pr.575 to Pr.577	601
73	X73	Second PID P control switchover	Pr.127 to Pr.134, Pr.575 to Pr.577	601
74	X74	Magnetic flux decay output shutoff	Pr.850	717
76	X76	Proximity dog	Pr.1282 to Pr.1288	303
77	X77	Pre-charge end command	Pr.760 to Pr.764	618
78	X78	Second pre-charge end command	Pr.765 to Pr.769	618
79	X79	Second PID forward/reverse action switchover	Pr.753 to Pr.758	601
80	X80	Second PID control valid	Pr.753 to Pr.758	601
85	X85	SSCNET III communication disabled (for FR-A8NS) <sup>*6</sup>	Pr.499	—
87	X87	Sudden stop	Pr.464 to Pr.494	303
88	LSP	Forward stroke end	Pr.419	316, 319
89	LSN	Reverse stroke end		
92	X92	Emergency stop	Pr.1103	367
93	X93	Torque control selection	Pr.1113	287
94	X94	Control signal input for main circuit power supply MC	Pr.30, Pr.137, Pr.248, Pr.254	569
95	X95	Converter unit fault input	Pr.57, Pr.58, Pr.135 to Pr.139, Pr.159	563
96	X96	Converter unit fault (E.OHT, E.CPU) input		
128	RLF	Low-speed forward rotation command	Pr.6	411
129	RLR	Low-speed reverse rotation command		
9999	-	No function	—	—

\*1 When **Pr.59 Remote function selection** ≠ "0", functions of the RL, RM, and RH signals are changed as shown in the table.

\*2 When **Pr.270 Stop-on contact/load torque high-speed frequency control selection** = "1, 3, 11, or 13", functions of the RL and RT signals are changed as shown in the table.

\*3 The OH signal is activated when the relay contact is open.

\*4 When a stop position command is input from outside for orientation control, the FR-A8AX (16-bit digital input option) is required.

\*5 Servo ON is enabled in the position control mode.

\*6 Available when the plug-in option is connected. For details, refer to the Instruction Manual of each option.

\*7 The setting is available for the standard structure model and the IP55 compatible model.

## NOTE

- The same function can be assigned to two or more terminals. In this case, the logic of terminal input is OR.
- The priorities of the speed commands are defined as follows: JOG > multi-speed setting (RH, RM, RL, REX) > PID (X14).
- When the Inverter run enable (X10) signal is not assigned, or when the PU operation external interlock (X12) signal is not assigned while **Pr.79 Operation mode selection** = "7", the MRS signal performs the same function.
- The same terminals are used to assign the multi-speed (7-speed) setting and the remote setting. The multi-speed setting and the remote setting cannot be assigned separately.
- When the Load pattern selection forward/reverse rotation boost (X17) signal is not assigned, the RT signal performs the same function.
- When **Pr.419** = "2" (simple pulse train position command), the terminal JOG is used for the simple position pulse train input regardless of the setting in **Pr.291 Pulse train I/O selection**.
- When the terminal assignment is changed using **Pr.178 to Pr.189 (Input terminal function selection)**, wiring may be mistaken due to different terminal name and signal contents, or may affect other functions. Set parameters after confirming the function of each terminal.



## ◆ Adjusting the response of input terminals (Pr.699)

- Response of the input terminals can be delayed in a range between 5 to 50 ms. (The following is the operation example of the STF signal.)

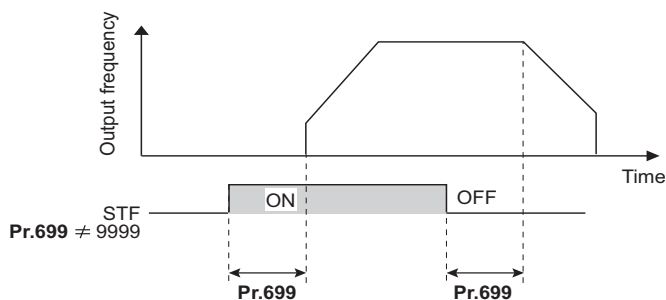

### NOTE

- The **Pr.699** setting is invalid (no filter) for the following signals.
  - Input signals which are already in the ON state when the power is turned ON
  - Input signals used for the PLC function
  - Inverter run enable (X10) signal, Simple position pulse train sign (NP) signal, Simple position drop pulse clear (CLR) signal

## 5.12.9 Inverter output shutoff

The inverter output can be shut off with the MRS signal. The logic of the MRS signal can also be selected.

Pr.	Name	Initial value	Setting range	Description
17 T720	MRS input selection	0	0	Normally open input
			2	Normally closed input (NC contact input specification)
			4	External terminal: Normally closed input (NC contact input specification) Communication: Normally open input

### ◆ Output shutoff signal (MRS signal)

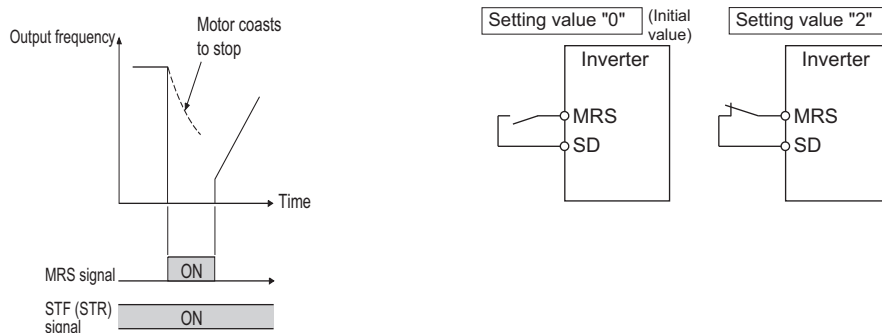

- When the Output stop (MRS) signal is turned ON while operating the inverter, the inverter output is instantaneously shut off.
- The response time of the MRS signal is within 2 ms.
- The MRS signal is used in the following cases.

Application	Description
To stop the motor using a mechanical brake (e.g. electromagnetic brake)	The inverter output is shut off when the mechanical brake operates.
To provide interlock to disable the motor operation by the inverter	With the MRS signal ON, the motor cannot be driven by the inverter even if the start signal is input to the inverter.
To coast the motor to a stop	When the start signal is turned OFF, the inverter decelerates the motor to a stop in the preset deceleration time, but when the MRS signal is turned ON, the motor coasts to a stop.

## ◆ MRS signal logic inversion (Pr.17 = "2")

- When "2" is set in Pr.17, the input specification of the MRS signal is changed to normally closed (NC contact). The inverter will shut off the output when the MRS signal is turned OFF (when the contact is opened).

## ◆ Assigning a different action for each MRS signal input via communication and external terminal (Pr.17 = "4")

- When Pr.17 = "4", the MRS signal input from an external terminal is normally closed (NC contact), and the MRS signal input from communication is normally open (NO contact). This function is useful to perform operation via communication while keeping the ON state of the MRS signal input from the external terminal.

External MRS	Communication MRS	Pr.17 setting		
		0	2	4
OFF	OFF	Operation enabled	Output shutoff	Output shutoff
OFF	ON	Output shutoff	Output shutoff	Output shutoff
ON	OFF	Output shutoff	Output shutoff	Operation enabled
ON	ON	Output shutoff	Operation enabled	Output shutoff

5

### NOTE

- The MRS signal is assigned to terminal MRS in the initial status. By setting "24" in any of Pr.178 to Pr.189 (Input terminal function selection), the MRS signal can be assigned to the other terminal.
- When using an external terminal to input the MRS signal, the MRS signal shuts off the output in any of the operation modes.
- The MRS signal is valid regardless of whether it is input through the external terminal or via network, but when the MRS signal is used as the Inverter run enable (X10) signal, input the signal through the external terminal.
- When the terminal assignment is changed using Pr.178 to Pr.189 (Input terminal function selection), wiring may be mistaken due to different terminal name and signal contents, or may affect other functions. Set parameters after confirming the function of each terminal.

### Parameters referred to

Pr.178 to Pr.189 (Input terminal function selection) [page 521](#)

## 5.12.10 External fault input signal

The inverter output can be shut off by inputting the External fault input (X32) signal when an external fault occurs. To assign the X32 signal, set "32" in any of Pr.178 to Pr.189 (Input terminal function selection).

### ◆ Details of the operation

- When the External fault input (X32) signal turns OFF during operation, the inverter activates the protective function with the indication "E.EF" displayed to shut off the output.
- When the X32 signal turns OFF during a stop, the protective function is not activated ("E.EF" is not displayed).
- When the inverter operation is started with the X32 signal OFF, the inverter activates the protective function immediately to shut off the output.

### NOTE

- When the X32 signal turns OFF during zero speed control or pre-excitation while the start signal is OFF, the inverter output is shut off.
- When the inverter operation is started with the X32 signal OFF, the inverter may output the AC voltage for an extremely brief moment.

## 5.12.11 Selecting the condition to activate the Second function selection (RT) signal or the Third function selection (X9) signal

The second function can be selected using the RT signal, and the third function can be selected using the X9 signal.

The condition to activate the second or third function can be also set.

Pr.	Name	Initial value	Setting range	Description
155 T730	RT signal function validity condition selection	0	0	The second function is immediately enabled when the RT signal is turned ON, and the third function is immediately enabled when the X9 signal is turned ON.
			10	The function cannot be changed to the second or third function during acceleration/deceleration. When the signal is turned ON during acceleration/deceleration, the function is changed after the acceleration/deceleration is finished.

- Turning ON the Second function selection (RT) signal enables the second functions.
- Turning ON the Third function selection (X9) signal enables the third functions. For the X9 signal, set "9" in any of **Pr.178 to 189 (Input terminal function selection)** to assign the function.
- The following are the examples of the applications of the second (third) functions.
  - Switching between regular use and emergency use
  - Switching between heavy load and light load
  - Changing the acceleration/deceleration time by break point acceleration/deceleration
  - Switching characteristics of main motor and sub motor

Connection diagram example for the second function

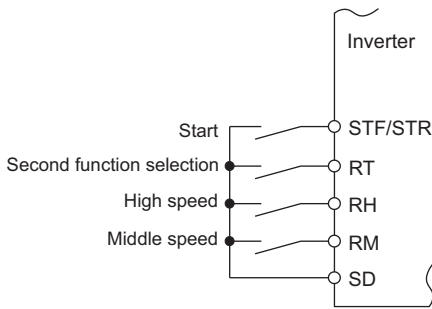

Example of the second acceleration/deceleration time

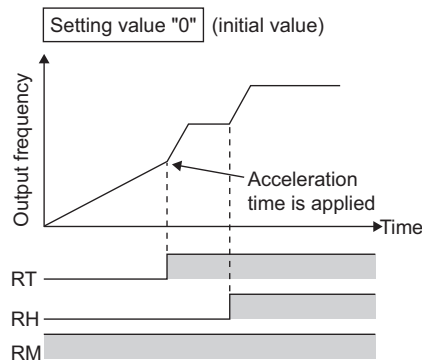

- Turning ON the RT signal enables the second function, and turning ON the X9 signal enables the third function. The following table shows the functions which can be changed to the second or third function.

Function	First function parameter number	Second function parameter number	Third function parameter number	Refer to page
Torque boost	Pr.0	Pr.46	Pr.112	706
Base frequency	Pr.3	Pr.47	Pr.113	707
Acceleration time	Pr.7	Pr.44	Pr.110	367
Deceleration time	Pr.8	Pr.44, Pr.45	Pr.110, Pr.111	367
Electronic thermal O/L relay	Pr.9	Pr.51	*2	415
Free thermal	Pr.600 to Pr.604	Pr.692 to Pr.696	*2	
Motor permissible load level *1	Pr.607	Pr.608	*2	
Stall prevention	Pr.22	Pr.48, Pr.49	Pr.114, Pr.115	431
Applied motor *1	Pr.71	Pr.450	*2	528
Motor constant*1	Pr.80 to Pr.84, Pr.90 to Pr.94, Pr.298, Pr.702, Pr.706, Pr.707, Pr.711, Pr.712, Pr.717, Pr.721, Pr.724, Pr.725, Pr.859	Pr.453 to Pr.457, Pr.560, Pr.458 to Pr.462, Pr.738 to Pr.747, Pr.860	*2	532, 551
Excitation current low-speed scaling factor	Pr.85, Pr.86	Pr.565, Pr.566	*2	711
Speed control gain (Advanced magnetic flux vector)	Pr.89	Pr.569	*2	228
Offline auto tuning*1	Pr.96	Pr.463	*2	532, 551
Online auto tuning *1	Pr.95	Pr.574	*2	558
PID control	Pr.127 to Pr.134	Pr.753 to Pr.758	*2	601
PID pre-charge function	Pr.760 to Pr.764	Pr.765 to Pr.769	*2	618
Brake sequence*1	Pr.278 to Pr.285, Pr.639, Pr.640	Pr.641 to Pr.648, Pr.650 to Pr.651	*2	572
Droop control	Pr.286 to Pr.288, Pr.994 to Pr.995	Pr.679 to Pr.683	*2	738
Low-speed range torque characteristics *1	Pr.788	Pr.747	*2	233
Motor control method *1	Pr.800	Pr.451	*2	221
Speed control gain	Pr.820, Pr.821	Pr.830, Pr.831	*2	254
Analog input filter	Pr.822, Pr.826	Pr.832, Pr.836	*2	503
Speed detection filter	Pr.823	Pr.833	*2	332
Torque control gain	Pr.824, Pr.825	Pr.834, Pr.835	*2	294
Torque detection filter	Pr.827	Pr.837	*2	332

\*1 The function can be changed by switching the RT signal ON/OFF while the inverter is stopped. If a signal is switched during operation, the operation method changes after the inverter stops. (Pr.450 ≠ 9999)

\*2 When the RT signal is OFF, the first function is valid. When it is ON, the second function is valid.

#### NOTE

- The RT signal is assigned to terminal RT in the initial status. By setting "3" in any of **Pr.178 to Pr.189 (Input terminal function selection)**, the RT signal can be assigned to the other terminal.
- When both the RT and X9 signals are ON, the X9 signal (third function) is valid.
- Changing the terminal assignment using **Pr.178 to Pr.189 (Input terminal function selection)** may affect the other functions. Set parameters after confirming the function of each terminal.

#### Parameters referred to

Pr.178 to Pr.189 (Input terminal function selection)  page 521

## 5.13 (C) Motor constant parameters

Purpose	Parameter to set			Refer to page
To select the motor to be used	Applied motor	P.C100, P.C200	Pr.71, Pr.450	528
To maximize the performance of the induction and vector motors	Offline auto tuning	P.C000, P.C100 to P.C105, P.C107, P.C108, P.C110, P.C120 to P.C126, P.C200 to P.C205, P.C207, P.C208, P.C210, P.C220 to P.C226	Pr.9, Pr.51, Pr.71, Pr.80 to Pr.84, Pr.90 to Pr.94, Pr.96, Pr.450, Pr.453 to Pr.463, Pr.684, Pr.707, Pr.724, Pr.744, Pr.745, Pr.859, Pr.860	532
To maximize the performance of the PM motor to perform Vector control operation	PM motor offline auto tuning (under Vector control)	P.C000, P.C100 to P.C108, P.C110, P.C120, P.C122, P.C123, P.C126, P.C130 to P.C133, P.C135, P.C150, P.C200 to P.C208, P.C210, P.C220, P.C222, P.C223, P.C226, P.C230 to P.C233, P.C235	Pr.9, Pr.51, Pr.71, Pr.80, Pr.81, Pr.83, Pr.84, Pr.90, Pr.92, Pr.93, Pr.96, Pr.450, Pr.453, Pr.454, Pr.456 to Pr.458, Pr.460, Pr.461, Pr.463, Pr.684, Pr.702, Pr.706, Pr.707, Pr.711, Pr.712, Pr.724, Pr.725, Pr.738 to Pr.740, Pr.743 to Pr.746, Pr.859, Pr.860, Pr.1002, Pr.1412, Pr.1413	542
To maximize the performance of the PM motor to perform PM sensorless vector control operation	PM motor offline auto tuning	P.C000, P.C100 to P.C108, P.C110, P.C120, P.C122, P.C123, P.C126, P.C130 to P.C133, P.C135, P.C150, P.C182, P.C185, P.C200 to P.C208, P.C210, P.C220, P.C222, P.C223, P.C226, P.C230 to P.C233, P.C235, P.C282, P.C285	Pr.9, Pr.51, Pr.71, Pr.80, Pr.81, Pr.83, Pr.84, Pr.90, Pr.92, Pr.93, Pr.96, Pr.450, Pr.453, Pr.454, Pr.456 to Pr.458, Pr.460, Pr.461, Pr.463, Pr.684, Pr.702, Pr.706, Pr.707, Pr.711, Pr.712, Pr.717, Pr.721, Pr.724, Pr.725, Pr.738 to Pr.747, Pr.788, Pr.859, Pr.860, Pr.1002, Pr.1412, Pr.1413	551
To perform high accuracy operation without being affected by temperature and high-torque/ultra-low speed	Online auto tuning	P.C111, P.C211	Pr.95, Pr.574	558
To use the motor with encoder	Encoder specifications	P.C140, P.C141, P.C240, P.C241	Pr.359, Pr.369, Pr.851, Pr.852	94
To detect loss of encoder signals	Signal loss detection	P.C148, P.C248	Pr.376, Pr.855	561

### 5.13.1 Applied motor

By setting the applied motor type, the thermal characteristic appropriate for the motor can be selected.

When using a constant-torque or PM motor, the electronic thermal O/L relay function is set according to the motor.

When the Advanced magnetic flux vector control, Real sensorless vector control, Vector control, or PM sensorless vector control is selected, the motor constant necessary for control (SF-PR, SF-JR, SF-HR, SF-JRCA, SF-HRCA, SF-V5RU (1500 r/min series), MM-CF, etc.) is also selected at the same time.

Pr.	Name	Initial value	Setting range	Description
<b>71</b> <b>C100</b>	<b>Applied motor</b>	0	0 to 6, 13 to 16, 20, 23, 24, 30, 33, 34, 40, 43, 44, 50, 53, 54, 70, 73, 74, 330, 333, 334, 8090, 8093, 8094, 9090, 9093, 9094	By selecting a motor, the thermal characteristic and motor constant of each motor are set.
<b>450</b> <b>C200</b>	<b>Second applied motor</b>	9999	0, 1, 3 to 6, 13 to 16, 20, 23, 24, 30, 33, 34, 40, 43, 44, 50, 53, 54, 70, 73, 74, 330, 333, 334, 8090, 8093, 8094, 9090, 9093, 9094	Set this parameter when using the second motor (the same specifications as <b>Pr.71</b> ).
			9999	The function is disabled.

## ◆ Setting the applied motor

- Refer to the following list and set the parameters according to the applied motor.

Pr.71	Pr.450	Motor	Motor constant value range when performing offline auto tuning (increment)	Electronic thermal O/L relay function		
				Standard	Constant-torque	PM
0 (Pr.71 initial value)		Standard motor (such as SF-JR)	<b>Pr.82 (Pr.455) and Pr.859 (Pr.860)</b> • 0 to 500 A, 9999 (0.01 A) <sup>*2</sup> • 0 to 3600 A, 9999 (0.1 A) <sup>*3</sup> <b>Pr.90 (Pr.458), Pr.91 (Pr.459)</b> • 0 to 50 Ω, 9999 (0.001 Ω) <sup>*2</sup> • 0 to 400 mΩ, 9999 (0.01 mΩ) <sup>*3</sup> <b>Pr.92 (Pr.460), Pr.93 (Pr.461) (Induction motor)</b> • 0 to 6000 mH, 9999 (0.1 mH) <sup>*2</sup> • 0 to 400 mH, 9999 (0.1 mH) <sup>*3</sup> <b>Pr.92 (Pr.460), Pr.93 (Pr.461) (PM motor)</b> • 0 to 500 mH, 9999 (0.01 mH) <sup>*2</sup> • 0 to 50 mH, 9999 (0.001 mH) <sup>*3</sup> <b>Pr.94 (Pr.462)</b> • 0 to 100%, 9999 (0.1%) <sup>*2</sup> • 0 to 100%, 9999 (0.01%) <sup>*3</sup> <b>Pr.706 (Pr.738)</b> • 0 to 5000 mV (rad/s), 9999 (0.1 mV/(rad/s))	○		
1		Constant-torque motor (SFJRCA, etc.) SF-V5RU (other than the 1500 r/min series)			○	
2	—	Standard motor (such as SF-JR) Adjustable 5 points V/F (refer to page 713)			○	
20		Mitsubishi Electric standard motor (SF-JR 4P 1.5kW or lower)			○	
30		Vector control dedicated motor SF-V5RU (1500 r/min series) SF-THY			○	
40		Mitsubishi Electric high-efficiency motor SF-HR			○	
50		Mitsubishi Electric constant-torque motor SF-HRCA			○	
70		Mitsubishi Electric high-performance energy-saving motor SF-PR			○	
330 <sup>*1</sup>		IPM motor MM-CF				○
8090		IPM motor (other than MM-CF)			○	
9090		SPM motor			○	

Pr.71	Pr.450	Motor	Motor constant value range when performing offline auto tuning (increment)	Electronic thermal O/L relay function		
				Standard	Constant-torque	PM
3 (4) <sup>*4</sup>		Standard motor (such as SF-JR)	<b>Pr.82 (Pr.455), Pr.859 (Pr.860), Pr.90 (Pr.458), Pr.91 (Pr.459), Pr.92 (Pr.460), Pr.93 (Pr.461), Pr.94 (Pr.462), Pr.706 (Pr.738)</b> • Internal data value 0 to 65534, 9999 (1) The display increment can be changed in <b>Pr.684</b> .	○		
13 (14) <sup>*4</sup>		Constant-torque motor (SFJRCA, etc.) SF-V5RU (other than the 1500 r/min series)			○	
23 (24) <sup>*4</sup>		Mitsubishi Electric standard motor (SF-JR 4P 1.5kW or lower)			○	
33 (34) <sup>*4</sup>		Vector control dedicated motor SF-V5RU (1500 r/min series) SF-THY			○	
43 (44) <sup>*4</sup>		Mitsubishi Electric high-efficiency motor SF-HR			○	
53 (54) <sup>*4</sup>		Mitsubishi Electric constant-torque motor SF-HRCA			○	
73 (74) <sup>*4</sup>		Mitsubishi Electric high-performance energy-saving motor SF-PR			○	
333 (334) <sup>*1*4</sup>		IPM motor MM-CF				○
8093 (8094) <sup>*4</sup>		IPM motor (other than MM-CF)			○	
9093 (9094) <sup>*4</sup>		SPM motor			○	
5		Standard motor	<b>Pr.82 (Pr.455) and Pr.859 (Pr.860)</b> • 0 to 500 A, 9999 (0.01 A) <sup>*2</sup> • 0 to 3600 A, 9999 (0.1 A) <sup>*3</sup> <b>Pr.90 (Pr.458), Pr.91 (Pr.459)</b> • 0 to 50 Ω, 9999 (0.001 Ω) <sup>*2</sup> • 0 to 400 mΩ, 9999 (0.01 mΩ) <sup>*3</sup> <b>Pr.92 (Pr.460), Pr.93 (Pr.461)</b> • 0 to 50 Ω, 9999 (0.001 Ω) <sup>*2</sup> • 0 to 3600 mΩ, 9999 (0.1 mΩ) <sup>*3</sup> <b>Pr.94 (Pr.462)</b> • 0 to 500 Ω, 9999 (0.01 Ω) <sup>*2</sup> • 0 to 100 Ω, 9999 (0.01 Ω) <sup>*3</sup>	○		
15		Constant-torque motor		Wye connection		○
6		Standard motor	Delta connection	○		
16		Constant-torque motor				○
—	9999 (initial value)	No second applied motor				

\*1 The setting is available for the FR-A820-00630(11K) or lower.

\*2 For the FR-A820-03160(55K) or lower, and FR-A840-01800(55K) or lower.

\*3 For the FR-A820-03800(75K) or higher, and FR-A840-02160(75K) or higher.

\*4 The same operation is performed for the both settings.

## NOTE

- Regardless of the **Pr.71 (Pr.450)** setting, offline auto tuning can be performed according to **Pr.96 (Pr.463) Auto tuning setting/status**. (Refer to [page 532](#) for offline auto tuning.)

## ◆ Using two types of motors (RT signal, Pr.450)

- When using two types of motors with one inverter, set **Pr.450 Second applied motor**.
- The setting value "9999" (initial value) disables the second motor.
- If **Pr.450** ≠ 9999, the following parameters will be enabled by turning ON the Second function selection (RT) signal.

Function	RT signal ON (second motor)	RT signal OFF (first motor)
Electronic thermal O/L relay	Pr.51	Pr.9
Applied motor	Pr.450	Pr.71
Control method selection	Pr.451	Pr.800
Motor capacity	Pr.453	Pr.80
Number of motor poles	Pr.454	Pr.81
Motor excitation current	Pr.455	Pr.82
Rated motor voltage	Pr.456	Pr.83
Rated motor frequency	Pr.457	Pr.84
Motor constant (R1)	Pr.458	Pr.90
Motor constant (R2)	Pr.459	Pr.91
Motor constant (L1)/d-axis inductance (Ld)	Pr.460	Pr.92
Motor constant (L2)/q-axis inductance (Lq)	Pr.461	Pr.93
Motor constant (X)	Pr.462	Pr.94
Auto tuning setting/status	Pr.463	Pr.96
Frequency search gain	Pr.560	Pr.298
Online auto tuning selection	Pr.574	Pr.95
Induced voltage constant ( $\phi f$ )	Pr.738	Pr.706
Motor Ld decay ratio	Pr.739	Pr.711
Motor Lq decay ratio	Pr.740	Pr.712
Starting resistance tuning compensation	Pr.741	Pr.717
Starting magnetic pole position detection pulse width	Pr.742	Pr.721
Maximum motor frequency	Pr.743	Pr.702
Motor inertia (integer)	Pr.744	Pr.707
Motor inertia (exponent)	Pr.745	Pr.724
Motor protection current level	Pr.746	Pr.725
Torque current/Rated PM motor current	Pr.860	Pr.859

#### NOTE

- The RT signal is the Second function selection signal. The RT signal also enables other second functions. (Refer to [page 525](#).)
- The RT signal is assigned to terminal RT in the initial status. Set "3" in one of **Pr.178 to Pr.189 (Input terminal function selection)** to assign the RT signal to another terminal.
- Changing the terminal assignment using **Pr.178 to Pr.189 (Input terminal function selection)** may affect the other functions. Set parameters after confirming the function of each terminal.

### ◆ Automatic change of torque boost for the SF-PR motor

- When the SF-PR motor is selected (**Pr.71** = "70, 73, or 74"), the **Pr.0 Torque boost** is automatically changed to enable output of the 6 Hz 150% torque under V/F control by setting **Pr.81 Number of motor poles** according to the number of the SF-PR motor poles.

#### NOTE

- When selecting the automatic change of torque boost for the SF-PR motor, set **Pr.14 Load pattern selection** = "0 (initial value)".
- When the **Pr.0** setting is changed from its initial value, the automatic change is not performed.

### ◆ Automatic change of Pr.0 Torque boost and Pr.12 DC injection brake operation voltage

- When initial values are set in **Pr.0** and **Pr.12**, the **Pr.0** and **Pr.12** settings are automatically changed to the values in the following table by changing the **Pr.71** setting.



Inverter		Pr.0 value (%) after automatic change								Pr.12 value (%) after automatic change		
FR-A820-[]	FR-A840-[]	Standard motor <sup>*1</sup>		Constant-torque motor <sup>*2</sup>		SF-PR <sup>*3</sup>				Standard motor <sup>*1</sup>	Constant-torque motor <sup>*2</sup>	SF-PR <sup>*3</sup>
		SLD/LD	ND/HD	SLD/LD	ND/HD	Pr.81 ≠ 2, 4, 6	Pr.81 = 2	Pr.81 = 4	Pr.81 = 6			
00046 (0.4K)	00023 (0.4K)	6		6		4	4	4	4	4	4	4
00077(0.75K)	00038(0.75K)	6		6		4	7.4	6	6.4	4	4	4
00105(1.5K)	00052(1.5K)	4		4		3	5.8	5	3.7	4	4	2.5
00167(2.2K)	00083(2.2K)	4		4		2.5	6	4.5	3.3	4	4	2.5
00250(3.7K)	00126(3.7K)	4		4		2.5	6.4	4.5	4.2	4	4	2.5
00340(5.5K)	00170(5.5K)	3		2		2	4.5	3.7	3.3	4	2	2
00490(7.5K)	00250(7.5K)	3		2		2	4.4	4.5	3.8	4	2	2
00630(11K)	00310(11K)	2		2		1.5	3.5	3.3	3.5	2	2	1.5
00770(15K)	00380(15K)	2		2		1.5	4.5	3	3.5	2	2	1.5
00930(18.5K)	00470(18.5K)	2		2		1.5	4	3.2	3	2	2	1.5
01250(22K)	00620(22K)	2		2		1.5	2.5	3.4	3	2	2	1
01540(30K)	00770(30K)	2		2		1	3	2	2.5	2	2	1
01870(37K)	00930(37K)	2		2		1	2	2.5	2.6	2	2	1
02330(45K)	01160(45K)	1.5	2	1.5	2	1	2	2	2.4	2	2	1
03160(55K)	01800(55K)	1.5	2	1.5	2	0.7	2	2	0.7	2	2	1
03800 (75K) or higher	02160 (75K) or higher	1		1		1	1	1	1	1	1	1

\*1 Pr.71 = "0, 2 to 6, 20, 23, 24, 40, 43, or 44" (standard motor)

\*2 Pr.71 = "1, 13 to 16, 50, 53, or 54" (constant-torque motor)

\*3 Pr.71 = "70, 73, or 74" (SF-PR)

**NOTE**

- When the Pr.0 and Pr.12 settings are changed from their initial values, the automatic change is not performed.
- When the SF-PR motor is selected (Pr.71 = "70, 73, or 74"), the output current may become large due to a small load by setting **Pr.81 Number of motor poles** according to the number of the SF-PR motor poles.
- When the SF-PR motor is used, the output current tends to increase compared with the case where the SF-JR or SF-HR motor is used. Depending on the load conditions, the output current may increase even though the torque boost value has been automatically changed. When the protective function such as the electronic thermal O/L relay (E.THT, E.THM) or stall prevention (OL, E.OLT) is activated, adjust the **Pr.0 Torque boost** according to the load.

**CAUTION**

- Make sure to set this parameter correctly according to the motor used. Incorrect setting may cause the motor and the inverter to overheat and burn.

Parameters referred to

- Pr.0 Torque boost [page 706](#)
- Pr.12 DC injection brake operation voltage [page 715](#)
- Pr.14 Load pattern selection [page 708](#)
- Pr.96 Auto tuning setting/status [page 532](#)
- Pr.100 to Pr.109 (Adjustable 5 points V/F) [page 713](#)
- Pr.178 to Pr.189 (Input terminal function selection) [page 521](#)
- Pr.684 Tuning data unit switchover [page 532](#)
- Pr.800 Control method selection [page 221](#)

## 5.13.2 Offline auto tuning for an induction motor

Magnetic flux | Sensorless | Vector

The offline auto tuning enables the optimal operation of a motor.

- Under Advanced magnetic flux vector control, Real sensorless vector control, or Vector control, automatic measurement of motor constants (offline auto tuning) enables optimal operation of motors even when motor constants vary, when a motor of another company is used, or when the wiring distance is long.

For the offline auto tuning for a PM motor, refer to [page 551](#).

Pr.	Name	Initial value	Setting range	Description
684 C000	Tuning data unit switchover	0	0	Internal data converted value
			1	The value is indicated in A, Ω, mH, or %.
71 C100	Applied motor	0	0 to 6, 13 to 16, 20, 23, 24, 30, 33, 34, 40, 43, 44, 50, 53, 54, 70, 73, 74, 330, 333, 334, 8090, 8093, 8094, 9090, 9093, 9094	By selecting a motor, the thermal characteristic and motor constant of each motor are set.
80 C101	Motor capacity	9999	0.4 to 55 kW <sup>*2</sup>	Set the applied motor capacity.
			0 to 3600 kW <sup>*3</sup>	
			9999	V/F control
81 C102	Number of motor poles	9999	2, 4, 6, 8, 10, 12	Set the number of motor poles.
			9999	V/F control
9 C103	Electronic thermal O/L relay	Inverter rated current <sup>*1</sup>	0 to 500 A <sup>*2</sup>	Set the rated motor current.
			0 to 3600 A <sup>*3</sup>	
83 C104	Rated motor voltage	200/400 V <sup>*4</sup>	0 to 1000 V	Set the rated motor voltage (V).
84 C105	Rated motor frequency	9999	10 to 400 Hz	Set the rated motor frequency (Hz).
			9999	The setting value of <b>Pr.3 Base frequency</b> is used.
707 C107	Motor inertia (integer)	9999	10 to 999, 9999	Set the motor inertia. 9999: The constant value of Mitsubishi Electric motor (SF-PR, SF-JR, SF-HR, SF-JRCA, SF-HRCA, SF-V5RU (1500 r/min series) and so on) is used.
724 C108	Motor inertia (exponent)	9999	0 to 7, 9999	
96 C110	Auto tuning setting/status	0	0	No offline auto tuning
			1	Offline auto tuning is performed without the motor rotating.
			11	Offline auto tuning is performed without rotating the motor (V/F control, IPM motor MM-CF). (Refer to <a href="#">page 638</a> .)
			101	Offline auto tuning is performed with the motor rotating.
90 C120	Motor constant (R1)	9999	0 to 50 Ω, 9999 <sup>*2*5</sup>	Tuning data (The value measured by offline auto tuning is automatically set.) 9999: The constant value of Mitsubishi Electric motor (SF-PR, SF-JR, SF-HR, SF-JRCA, SF-HRCA, SF-V5RU (1500 r/min series) and so on) is used.
			0 to 400 mΩ, 9999 <sup>*3*5</sup>	
91 C121	Motor constant (R2)	9999	0 to 50 Ω, 9999 <sup>*2*5</sup>	
			0 to 400 mΩ, 9999 <sup>*3*5</sup>	
92 C122	Motor constant (L1)/d-axis inductance (Ld)	9999	0 to 6000 mH, 9999 <sup>*2*5</sup>	
			0 to 400 mH, 9999 <sup>*3*5</sup>	
93 C123	Motor constant (L2)/q-axis inductance (Lq)	9999	0 to 6000 mH, 9999 <sup>*2*5</sup>	
			0 to 400 mH, 9999 <sup>*3*5</sup>	
94 C124	Motor constant (X)	9999	0 to 100%, 9999 <sup>*5</sup>	
82 C125	Motor excitation current	9999	0 to 500 A, 9999 <sup>*2*5</sup>	
			0 to 3600 A, 9999 <sup>*3*5</sup>	
859 C126	Torque current/ Rated PM motor current	9999	0 to 500 A, 9999 <sup>*2*5</sup>	
			0 to 3600 A, 9999 <sup>*3*5</sup>	
298 A711	Frequency search gain	9999	0 to 32767	The offline auto tuning automatically sets the gain required for the frequency search.
			9999	The constant value of Mitsubishi Electric motor (SF-PR, SF-JR, SF-HR, SF-JRCA, SF-HRCA and so on) is used.
450 C200	Second applied motor	9999	0, 1, 3 to 6, 13 to 16, 20, 23, 24, 30, 33, 34, 40, 43, 44, 50, 53, 54, 70, 73, 74, 330, 333, 334, 8090, 8093, 8094, 9090, 9093, 9094	Set this parameter when using the second motor (the same specifications as <b>Pr.71</b> ).
			9999	The function is disabled.
453 C201	Second motor capacity	9999	0.4 to 55 kW <sup>*2</sup>	Set the capacity of the second motor.
			0 to 3600 kW <sup>*3</sup>	
			9999	V/F control

Pr.	Name	Initial value	Setting range	Description
454 C202	Number of second motor poles	9999	2, 4, 6, 8, 10, 12	Set the number of poles of the second motor.
			9999	V/F control
51 C203	Second electronic thermal O/L relay	9999	0 to 500 A <sup>*2</sup>	This function is enabled when the RT signal is ON. Set the rated motor current.
			0 to 3600 A <sup>*3</sup>	
			9999	Second electronic thermal O/L relay disabled.
456 C204	Rated second motor voltage	200/400 V <sup>*4</sup>	0 to 1000 V	Set the rated voltage (V) of the second motor.
457 C205	Rated second motor frequency	9999	10 to 400 Hz	Set the rated frequency (Hz) of the second motor.
			9999	The <b>Pr.84 Rated motor frequency</b> setting is used.
744 C207	Second motor inertia (integer)	9999	10 to 999, 9999	Set the inertia of the second motor. 9999: The constant value of Mitsubishi Electric motor (SF-PR, SF-JR, SF-HR, SF-JRCA, SF-HRCA and so on) is used.
745 C208	Second motor inertia (exponent)	9999	0 to 7, 9999	
463 C210	Second motor auto tuning setting/status	0	0	No auto tuning for the second motor.
			1	Offline auto tuning is performed without the second motor rotating.
			11	Offline auto tuning is performed without rotating the motor (V/F control, IPM motor MM-CF). (Refer to <a href="#">page 638</a> .)
			101	Offline auto tuning is performed with the second motor rotating.
458 C220	Second motor constant (R1)	9999	0 to 50 Ω, 9999 <sup>*2*5</sup>	Tuning data of the second motor. (The value measured by offline auto tuning is automatically set.) 9999: The constant value of Mitsubishi Electric motor (SF-PR, SF-JR, SF-HR, SF-JRCA, SF-HRCA and so on) is used.
			0 to 400 mΩ, 9999 <sup>*3*5</sup>	
459 C221	Second motor constant (R2)	9999	0 to 50 Ω, 9999 <sup>*2*5</sup>	
			0 to 400 mΩ, 9999 <sup>*3*5</sup>	
460 C222	Second motor constant (L1) / d-axis inductance (Ld)	9999	0 to 6000 mH, 9999 <sup>*2*5</sup>	
			0 to 400 mH, 9999 <sup>*3*5</sup>	
461 C223	Second motor constant (L2) / q-axis inductance (Lq)	9999	0 to 6000 mH, 9999 <sup>*2*5</sup>	
			0 to 400 mH, 9999 <sup>*3*5</sup>	
462 C224	Second motor constant (X)	9999	0 to 100%, 9999 <sup>*5</sup>	
455 C225	Second motor excitation current	9999	0 to 500 A, 9999 <sup>*2*5</sup>	
			0 to 3600 A, 9999 <sup>*3*5</sup>	
860 C226	Second motor torque current/ Rated PM motor current	9999	0 to 500 A, 9999 <sup>*2*5</sup>	
			0 to 3600 A, 9999 <sup>*3*5</sup>	
560 A712	Second frequency search gain	9999	0 to 32767	The offline auto tuning automatically sets the gain required for the frequency search of the second motor.
			9999	The constant value of Mitsubishi Electric motor (SF-PR, SF-JR, SF-HR, SF-JRCA, SF-HRCA and so on) is used for the second motor.

\*1 For the FR-A820-00077(0.75K) or lower and FR-A840-00038(0.75K) or lower, it is set to 85% of the inverter rated current.

\*2 For the FR-A820-03160(55K) or lower, and FR-A840-01800(55K) or lower.

\*3 For the FR-A820-03800(75K) or higher, and FR-A840-02160(75K) or higher.

\*4 The initial value differs according to the voltage class (200 V / 400 V).

\*5 The setting range and unit change according to the **Pr.71 (Pr.450)** setting.

- The function is enabled under Advanced magnetic flux vector control, Real sensorless vector control, and Vector control.
- By using the offline auto tuning function, the optimum operation characteristics are obtained for a motor other than Mitsubishi Electric standard motors (SF-JR 0.4 kW or higher), high-efficiency motors (SF-HR 0.4 kW or higher), Mitsubishi Electric constant-torque motors (SF-JRCA 4P, SF-HRCA 0.4 kW to 55 kW), Mitsubishi Electric high-performance energy-serving motor (SF-PR), or Vector control dedicated motors (SF-V5RU (1500 r/min series)), such as an induction motor of other manufacturers, SF-JRC, or SF-TH, or with a long wiring length (30 m or longer).
- Tuning is enabled even when a load is connected to the motor.
- During offline auto tuning, the motor rotation can be locked (**Pr.96** = "1") or unlocked (**Pr.96** = "101"). The tuning is more accurate when the motor rotates.
- Reading/writing of the motor constants tuned by offline auto tuning are enabled. The offline auto tuning data (motor constants) can be copied to another inverter using the operation panel.
- The offline auto tuning status can be monitored on the operation panel or the parameter unit.

## ◆ Before performing offline auto tuning

Check the following points before performing offline auto tuning:

- Check that a value other than "9999" is set in **Pr.80** and **Pr.81**, and Advanced magnetic flux vector control, Real sensorless vector control, or Vector control is selected (with Pr.800).
- Check that a motor is connected. (Check that the motor is not rotated by an external force during tuning.)
- Select a motor with the rated current equal to or less than the inverter rated current. (The motor capacity must be 0.4 kW or higher.) If a motor with substantially low rated current compared with the inverter rated current, however, is used, speed and torque accuracies may deteriorate due to torque ripples, etc. Set the rated motor current to about 40% or higher of the inverter rated current.
- Tuning is not available for a high-slip motor, high-speed motor, or special motor.
- The maximum frequency is 400 Hz.
- The motor may rotate slightly even if offline auto tuning is performed without the motor rotating (**Pr.96 Auto tuning setting/status** = "1"). (The slight motor rotation does not affect the tuning performance.)  
Fix the motor securely with a mechanical brake, or before tuning, make sure that it is safe even if the motor rotates. (Caution is required especially in vertical lift applications.)
- Check the following points for the offline auto tuning with motor rotation (**Pr.96 Auto tuning setting/status** = "101").  
The torque is not sufficient during tuning.  
Check that the motor can be rotated up to the speed close to the rated speed.  
Check that the mechanical brake is released.
- Offline auto tuning is not performed correctly when the surge voltage suppression filter (FR-ASF-H/FR-BMF-H) is inserted between the inverter and motor. Be sure to remove it before performing tuning.
- Make sure to connect the encoder to the motor without coaxial misalignment for Vector control. Set the speed ratio to 1:1.

## ◆ Settings

- To perform tuning, set the following parameters about the motor.

First motor Pr.	Second motor Pr.	Name	Initial value	Description
80	453	Motor capacity	9999 (V/F control)	Set the motor capacity (kW).
81	454	Number of motor poles	9999 (V/F control)	Set the number of motor poles (2 to 12).
800	451	Control method selection	20	Set this parameter under Vector control or Real sensorless vector control.
9	51	Electronic thermal O/L relay	Inverter rated current	Set the rated motor current (A).
83	456	Rated motor voltage	200 V / 400 V <sup>*1</sup>	Set the rated motor voltage (V) printed on the motor's rating plate. <sup>*2</sup>
84	457	Rated motor frequency	9999	Set the rated motor frequency (Hz). <sup>*2</sup> When the setting is "9999", the <b>Pr.3 Base frequency</b> setting is used.
71	450	Applied motor	0 (standard motor)	Set this parameter according to the motor. <sup>*3</sup> Three types of motor constant setting ranges, units and tuning data can be stored according to settings.
96	463	Auto tuning setting/status	0	Set "1" or "101". 1: Tuning is performed without the motor rotating. (Excitation noise occurs at this point.) 101: Tuning is performed with the motor rotating. The motor can rotate up to the speed near the rated motor frequency.

\*1 The initial value differs according to the voltage class (200 V / 400 V).

\*2 For the settings for the SF-V5RU, refer to [page 94](#).

\*3 Set **Pr.71 Applied motor** according to the motor to be used and the motor constant setting range. According to the **Pr.71** setting, the range of the motor constant parameter setting values and units can be changed. (For other setting values of **Pr.71**, refer to [page 528](#).)

Motor		Pr.71 setting		
		Motor constant parameter mH, %, and A unit setting	Motor constant parameter internal data setting	Motor constant parameter $\Omega$ , m $\Omega$ , and A unit setting
Mitsubishi Electric standard motor Mitsubishi Electric high-efficiency motor	SF-JR, SF-TH	0 (initial value)	3 (4)	—
	SF-JR 4P 1.5 kW or lower	20	23 (24)	—
	SF-HR	40	43 (44)	—
	Others	0 (initial value)	3 (4)	—
Mitsubishi Electric constant-torque motor	SF-JRCA 4P, SF-TH (constant-torque)	1	13 (14)	—
	SF-HRCA	50	53 (54)	—
	Others (SF-JRC, etc.)	1	13 (14)	—
Mitsubishi Electric high-performance energy-saving motor	SF-PR	70	73 (74)	—
Vector control dedicated motor	SF-V5RU (1500 r/min series) SF-THY	30	33 (34)	—
	SF-V5RU (other than the 1500 r/min series)	1	13 (14)	—
Other manufacturer's standard motor	—	0 (initial value)	3 (4)	5 (wye connection motor) 6 (delta connection motor)
Other manufacturer's constant-torque motor	—	1	13 (14)	15 (wye connection motor) 16 (delta connection motor)

### NOTE

- When the SF-V5RU (other than the 1500 r/min series) is used, be sure to perform auto tuning after setting "1, 13, or 14" in **Pr.71** and setting **Pr.83** and **Pr.84**.
- When **Pr.11 DC injection brake operation time** = "0" or **Pr.12 DC injection brake operation voltage** = "0", offline auto tuning is performed at the initial setting of **Pr.11** or **Pr.12**.
- When position control is selected (**Pr.800** = "3 or 5" (when the MC signal is OFF)), offline auto tuning is not performed.
- If "wye connection" or "delta connection" is incorrectly selected in **Pr.71**, Advanced magnetic flux vector control, Real sensorless vector control, and Vector control are not performed properly.

- For tuning accuracy improvement, set the following parameters when the motor constants are known in advance.

First motor Pr.	Second motor Pr.	Name	Mitsubishi Electric motor (SF-JR, SF-HR, SF-JRCA, SF-HRCA, SF-V5RU)	Other motors
707	744	Motor inertia (integer)	9999 (initial value)	Motor inertia <sup>*4</sup>
724	745	Motor inertia (exponent)		Jm = Pr.707 × 10 <sup>^(-Pr.724)</sup> (kg·m <sup>2</sup> )

\*4 The setting is valid only when a value other than "9999" is set in both Pr.707 (Pr.744) and Pr.724 (Pr.745).

## ◆ Performing tuning

### Point

- Before performing tuning, check the monitor display of the operation panel or parameter unit if the inverter is in the state ready for tuning. The motor starts by turning ON the start command while tuning is unavailable.





- In the PU operation mode, press  /  on the operation panel.

For External operation, turn ON the start command (STF signal or STR signal). Tuning starts.

### NOTE

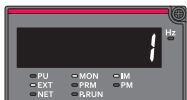
- Satisfy the required inverter start conditions to start offline auto tuning. For example, stop the input of the MRS signal.
- To force tuning to end, use the MRS or RES signal or  on the operation panel.  
(Turning OFF the start signal (STF signal or STR signal) also ends tuning.)
- During offline auto tuning, only the following I/O signals are valid (initial value).  
Input terminals <valid signals>: STP (STOP), OH, MRS, RT, RES, STF, STR, S1, and S2  
Output terminals: RUN, OL, IPF, FM/CA, AM, A1B1C1, and So (SO)
- When the rotation speed and the output frequency are selected for terminals FM/CA and AM, the progress status of offline auto tuning is output in 15 steps from FM/CA and AM.
- Do not perform ON/OFF switching of the Second function selection (RT) signal during offline auto tuning. Auto tuning will not be performed properly.
- Setting offline auto tuning (Pr.96 Auto tuning setting/status = "1 or 101") will make pre-excitation invalid.
- When the offline auto tuning with motor rotation is selected (Pr.96 Auto tuning setting/status = "101"), take caution and ensure safety against the rotation of the motor.
- Since the Inverter running (RUN) signal turns ON when tuning is started, pay close attention especially when a sequence which releases a mechanical brake by the RUN signal has been designed.
- When executing offline auto tuning, input the operation command after switching ON the main circuit power (R/L1, S/L2, T/L3) of the inverter.
- While Pr.79 Operation mode selection = "7", turn ON the PU operation external interlock (X12) signal for tuning in the PU operation mode.

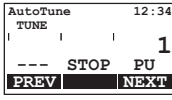
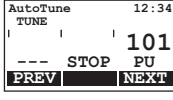
- During tuning, the monitor is displayed on the operation panel as follows.

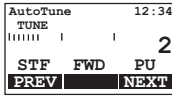
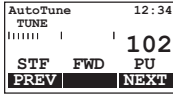
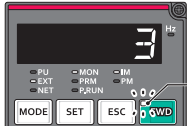
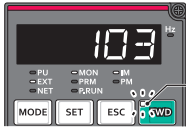
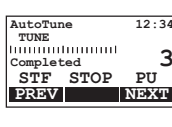
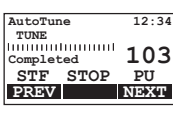
Tuning status	Operation panel (FR-DU08) display		LCD operation panel (FR-LU08) display	
	Pr.96 = "1"	Pr.96 = "101"	Pr.96 = "1"	Pr.96 = "101"
(1) Setting				
(2) During tuning				
(3) Normal completion				

- Note: Offline auto tuning time (with the initial setting)

Offline auto tuning setting	Time
No motor rotation (Pr.96 = "1")	About 25 to 120 s. (The time depends on the inverter capacity and motor type.)
With motor rotation (Pr.96 = "101")	About 40 s. (The following offline auto tuning time is set according to the acceleration/deceleration time setting. Offline auto tuning time = acceleration time + deceleration time + about 30 s)

- When offline auto tuning ends, press  on the operation panel during PU operation. For External operation, turn OFF the start signal (STF signal or STR signal).  
This operation resets the offline auto tuning, and the PU's monitor display returns to the normal indication.  
(Without this operation, next operation cannot be started.)

#### NOTE

- The motor constants measured once during offline auto tuning are stored as parameters and their data are held until offline auto tuning is performed again. However, the tuning data is cleared when performing All parameter clear.
- Changing Pr.71 (Pr.450) after tuning completion will change the motor constant. For example, if "3" is set in Pr.71 after tuning is performed with Pr.71 = "0", the tuning data becomes invalid. To use the tuned data, set "0" again in Pr.71.

- If offline auto tuning has ended in error (see the following table), motor constants are not set. Perform an inverter reset and restart tuning.

Error display	Error cause	Countermeasures
8	Forced end	Set Pr.96 = "1 or 101" and try again.
9	Inverter protective function operation	Make the setting again.
91	The current limit (stall prevention) function is activated.	Set the acceleration/deceleration time longer. Set Pr.156 Voltage reduction selection during stall prevention operation = "1".
92	The converter output voltage fell to 75% of the rated voltage.	Check for the power supply voltage fluctuation. Check the Pr.83 Rated motor voltage setting.
93	Calculation error. The motor is not connected.	Check the Pr.83 and Pr.84 settings. Check the motor wiring and make the setting again.
94	Rotation tuning frequency setting error. (The frequency command for the tuning was given to exceed the maximum frequency setting, or to be in the frequency jump range.)	Check the Pr.1 Maximum frequency and Pr.31 to Pr.36 Frequency jump settings.

- When tuning is ended forcibly by pressing  or turning OFF the start signal (STF or STR) during tuning, offline auto tuning does not end properly. (The motor constants have not been set.)  
Perform an inverter reset and perform tuning again.
- When the rated power supply of the motor is 200/220 V (400/440 V) 60 Hz, set the rated motor current multiplied by 1.1 in Pr.9 Electronic thermal O/L relay after tuning is complete.
- For a motor with a PTC thermistor, thermal protector, or other thermal detector, set "0" (motor overheat protection by inverter invalid) in Pr.9 to protect the motor from overheating.

#### NOTE

- An instantaneous power failure occurring during tuning will result in a tuning error. After power is restored, the inverter starts normal operation. Therefore, when the STF (STR) signal is ON, the motor starts forward (reverse) rotation.
- Any fault occurring during tuning is handled as in the normal operation. However, if the retry function is set, no retry is performed.
- The set frequency monitor displayed during the offline auto tuning is 0 Hz.

#### CAUTION

- Note that the motor may start running suddenly.
- For performing offline auto tuning with the motor rotating in vertical lift applications, etc., caution is required to avoid falling due to insufficient torque.



## ◆ Changing the motor constants

- The motor constants can be set directly when the motor constants are known in advance, or by using the data measured during offline auto tuning.
- According to the **Pr.71 (Pr.450)** setting, the range of the motor constant parameter setting values and units can be changed. The changed settings are stored in the EEPROM as the motor constant parameters.

## ◆ Changing the motor constants (when setting the Pr.92 and Pr.93 motor constants in units of mH)

- Set **Pr.71** as follows.

Motor	Pr.71 setting	
Mitsubishi Electric standard motor	SF-JR	0 (initial value)
	SF-JR 4P 1.5 kW or lower	20
Mitsubishi Electric high-efficiency motor	SF-HR	40
	SF-JRCA 4P	1
Mitsubishi Electric constant-torque motor	SF-HRCA	50
	SF-PR	70
Mitsubishi Electric high-performance energy-saving motor	SF-V5RU (1500 r/min series)	30
	SF-V5RU (other than the 1500 r/min series)	1

- Use the following formula to find the **Pr.94** setting value and set a desired value as the motor constant parameter.

$$\text{The setting value of Pr.94} = \left(1 - \frac{M^2}{L1 \times L2}\right) \times 100(\%)$$

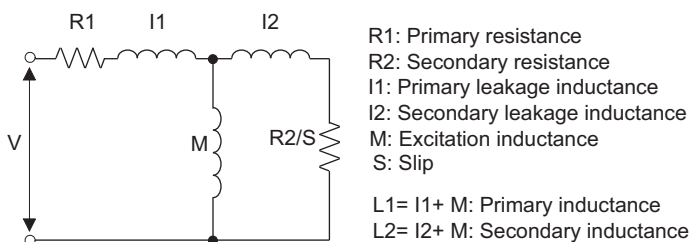

Equivalent circuit diagram of the motor

First motor Pr.	Second motor Pr.	Name	Setting range	Setting increments	Initial value
82	455	Motor excitation current (no load current)	0 to 500 A, 9999 <sup>*1</sup>	0.01 A <sup>*1</sup>	9999
			0 to 3600 A, 9999 <sup>*2</sup>	0.1 A <sup>*2</sup>	
90	458	Motor constant (R1)	0 to 50 Ω, 9999 <sup>*1</sup>	0.001 Ω <sup>*1</sup>	
			0 to 400 mΩ, 9999 <sup>*2</sup>	0.01 mΩ <sup>*2</sup>	
91	459	Motor constant (R2)	0 to 50 Ω, 9999 <sup>*1</sup>	0.001 Ω <sup>*1</sup>	
			0 to 400 mΩ, 9999 <sup>*2</sup>	0.01 mΩ <sup>*2</sup>	
92	460	Motor constant (L1)/d-axis inductance (Ld)	0 to 6000 mH, 9999 <sup>*1</sup>	0.1 mH <sup>*1</sup>	
			0 to 400 mH, 9999 <sup>*2</sup>	0.01 mH <sup>*2</sup>	
93	461	Motor constant (L2)/q-axis inductance (Lq)	0 to 6000 mH, 9999 <sup>*1</sup>	0.1 mH <sup>*1</sup>	
			0 to 400 mH, 9999 <sup>*2</sup>	0.01 mH <sup>*2</sup>	
94	462	Motor constant (X)	0 to 100%, 9999	0.1% <sup>*1</sup>	
				0.01% <sup>*2</sup>	
859	860	Torque current/Rated PM motor current	0 to 500 A, 9999 <sup>*1</sup>	0.01 A <sup>*1</sup>	
			0 to 3600 A, 9999 <sup>*2</sup>	0.1 A <sup>*2</sup>	
298	560	Frequency search gain	0 to 32767, 9999	1	

\*1 For the FR-A820-03160(55K) or lower, and FR-A840-01800(55K) or lower.

\*2 For the FR-A820-03800(75K) or higher, and FR-A840-02160(75K) or higher.



**NOTE**

- If "9999" is set, tuning data will be invalid and the constant values for Mitsubishi Electric motors (SF-PR, SF-JR, SF-HR, SF-JRCA, SF-HRCA and SF-V5RU (1500 r/min series) and so on) are used.

## ◆ Changing the motor constants (when setting motor constants in the internal data of the inverter)

- Set Pr.71 as follows.

Motor		Pr.71 setting
Mitsubishi Electric standard motor Mitsubishi Electric high-efficiency motor	SF-JR, SF-TH	3 (4)
	SF-JR 4P 1.5 kW or lower	23 (24)
	SF-HR	43 (44)
	Others	3 (4)
Mitsubishi Electric constant-torque motor	SF-JRCA 4P, SF-TH (constant-torque)	13 (14)
	SF-HRCA	53 (54)
	Others (SF-JRC, etc.)	13 (14)
Mitsubishi Electric high-performance energy-saving motor	SF-PR	73 (74)
Vector control dedicated motor	SF-V5RU (1500 r/min series), SF-THY	33 (34)
	SF-V5RU (other than the 1500 r/min series)	13 (14)
Other manufacturer's standard motor	—	3 (4)
Other manufacturer's constant-torque motor	—	13 (14)

- Set desired values as the motor constant parameters. The display units of the read motor constants can be changed with **Pr.684 Tuning data unit switchover**. Setting **Pr.684** = "1" disables parameter setting changes.

First motor Pr.	Second motor Pr.	Name	Pr.684 = 0 (initial value)		Pr.684 = 1		Initial value
			Setting range	Setting increments	Range indication	Unit indication	
82	455	Motor excitation current	0 to ***, 9999	1	0 to 500 A, 9999 <sup>*1</sup>	0.01 A <sup>*1</sup>	9999
					0 to 3600 A, 9999 <sup>*2</sup>	0.1 A <sup>*2</sup>	
90	458	Motor constant (R1)			0 to 50 Ω, 9999 <sup>*1</sup>	0.001 Ω <sup>*1</sup>	
					0 to 400 mΩ, 9999 <sup>*2</sup>	0.01 mΩ <sup>*2</sup>	
91	459	Motor constant (R2)			0 to 50 Ω, 9999 <sup>*1</sup>	0.001 Ω <sup>*1</sup>	
					0 to 400 mΩ, 9999 <sup>*2</sup>	0.01 mΩ <sup>*2</sup>	
92	460	Motor constant (L1)/d-axis inductance (Ld)			0 to 6000 mH, 9999 <sup>*1</sup>	0.1 mH <sup>*1</sup>	
					0 to 400 mH, 9999 <sup>*2</sup>	0.01 mH <sup>*2</sup>	
93	461	Motor constant (L2)/q-axis inductance (Lq)			0 to 6000 mH, 9999 <sup>*1</sup>	0.1 mH <sup>*1</sup>	
					0 to 400 mH, 9999 <sup>*2</sup>	0.01 mH <sup>*2</sup>	
94	462	Motor constant (X)	0 to 100%, 9999		0.1% <sup>*1</sup>		
					0.01% <sup>*2</sup>		
859	860	Torque current/Rated PM motor current	0 to 500 A, 9999 <sup>*1</sup>		0.01 A <sup>*1</sup>		
					0 to 3600 A, 9999 <sup>*2</sup>	0.1 A <sup>*2</sup>	
298	560	Frequency search gain	0 to 32767, 9999	1	0 to 32767, 9999	1	

\*1 For the FR-A820-03160(55K) or lower, and FR-A840-01800(55K) or lower.

\*2 For the FR-A820-03800(75K) or higher, and FR-A840-02160(75K) or higher.

**NOTE**

- As the motor constants measured in the offline auto tuning have been converted into internal data (\*\*\*\*), refer to the following setting example when making setting. (The value displayed has been converted into a value for internal use. Therefore, simple addition of a value to the displayed value does not bring the desired effect.)  
Setting example: To slightly increase the **Pr.90** value (5%)  
When "2516" is displayed for **Pr.90**, set 2642 (2516 × 1.05 = 2641.8) in **Pr.90**.
- If "9999" is set, tuning data will be invalid and the constant values for Mitsubishi Electric motors (SF-PR, SF-JR, SF-HR, SF-JRCA, SF-HRCA and SF-V5RU (1500 r/min series) and so on) are used.

## ◆ Changing the motor constants (when setting the Pr.92, Pr.93, and Pr.94 motor constants in units of Ω)

- Set Pr.71 as follows.

Applied motor	Pr.71 setting	
	Wye connection motor	Delta connection motor
Standard motor	5	6
Constant-torque motor	15	16

- Set desired values as the motor constant parameters.

$I_q$  = torque current,  $I_{100}$  = rated current,  $I_0$  = no load current

$$I_q = \sqrt{I_{100}^2 - I_0^2}$$

First motor Pr.	Second motor Pr.	Name	Setting range	Setting increments	Initial value
82	455	Motor excitation current (no load current)	0 to 500 A, 9999 <sup>*1</sup>	0.01 A <sup>*1</sup>	9999
			0 to 3600 A, 9999 <sup>*2</sup>	0.1 A <sup>*2</sup>	
90	458	Motor constant (r1)	0 to 50 Ω, 9999 <sup>*1</sup>	0.001 Ω <sup>*1</sup>	
			0 to 400 mΩ, 9999 <sup>*2</sup>	0.01 mΩ <sup>*2</sup>	
91	459	Motor constant (r2)	0 to 50 Ω, 9999 <sup>*1</sup>	0.001 Ω <sup>*1</sup>	
			0 to 400 mΩ, 9999 <sup>*2</sup>	0.01 mΩ <sup>*2</sup>	
92	460	Motor constant (x1)	0 to 50 Ω, 9999 <sup>*1</sup>	0.001 Ω <sup>*1</sup>	
			0 to 3600 mΩ, 9999 <sup>*2</sup>	0.1 mΩ <sup>*2</sup>	
93	461	Motor constant (x2)	0 to 50 Ω, 9999 <sup>*1</sup>	0.001 Ω <sup>*1</sup>	
			0 to 3600 mΩ, 9999 <sup>*2</sup>	0.1 mΩ <sup>*2</sup>	
94	462	Motor constant (xm)	0 to 500 Ω, 9999 <sup>*1</sup>	0.01 Ω	
			0 to 100 Ω, 9999 <sup>*2</sup>		
859	860	Torque current/Rated PM motor current	0 to 500 A, 9999 <sup>*1</sup>	0.01 A <sup>*1</sup>	
			0 to 3600 A, 9999 <sup>*2</sup>	0.1 A <sup>*2</sup>	
298	560	Frequency search gain	0 to 32767, 9999	1	

\*1 For the FR-A820-03160(55K) or lower, and FR-A840-01800(55K) or lower.

\*2 For the FR-A820-03800(75K) or higher, and FR-A840-02160(75K) or higher.

### NOTE

- If "wye connection" or "delta connection" is incorrectly selected in Pr.71, Advanced magnetic flux vector control, Real sensorless vector control, and Vector control are not performed properly.
- If "9999" is set, tuning data will be invalid and the constant values for Mitsubishi Electric motors (SF-PR, SF-JR, SF-HR, SF-JRCA, SF-HRCA and SF-V5RU (1500 r/min series) and so on) are used.

## ◆ Tuning the second motor

- When one inverter switches the operation between two different motors, set the second motor in Pr.450 Second applied motor. (Refer to page 528.) In the initial setting, no second motor is applied.
- Turning ON the RT signal enables the parameter settings for the second motor as follows.

Function	RT signal ON (second motor)	RT signal OFF (first motor)
Motor capacity	Pr.453	Pr.80
Number of motor poles	Pr.454	Pr.81
Motor excitation current	Pr.455	Pr.82
Rated motor voltage	Pr.456	Pr.83
Rated motor frequency	Pr.457	Pr.84
Motor constant (R1)	Pr.458	Pr.90
Motor constant (R2)	Pr.459	Pr.91
Motor constant (L1)/d-axis inductance (Ld)	Pr.460	Pr.92
Motor constant (L2)/q-axis inductance (Lq)	Pr.461	Pr.93
Motor constant (X)	Pr.462	Pr.94
Auto tuning setting/status	Pr.463	Pr.96
Frequency search gain	Pr.560	Pr.298

**NOTE**

- The RT signal is assigned to terminal RT in the initial status. Set "3" in one of **Pr.178 to Pr.189 (Input terminal function selection)** to assign the RT signal to another terminal.
- Changing the terminal assignment using **Pr.178 to Pr.189 (Input terminal function selection)** may affect the other functions. Set parameters after confirming the function of each terminal.

«Parameters referred to»

- Pr.1 Maximum frequency [page 428](#)
- Pr.9 Electronic thermal O/L relay [page 415](#)
- Pr.31 to Pr.36 Frequency jump [page 429](#)
- Pr.71 Applied motor [page 528](#)
- Pr.156 Stall prevention operation selection [page 431](#)
- Pr.178 to Pr.189 (Input terminal function selection) [page 521](#)
- Pr.190 to Pr.196 (Output terminal function selection) [page 473](#)
- Pr.800 Control method selection [page 221](#)

### 5.13.3 Offline auto tuning for a PM motor (under Vector control)

**Vector**

The offline auto tuning enables the optimal operation of a PM motor (under Vector control).

- Automatic measurement of motor constants (offline auto tuning) enables optimal operation of motors for Vector control even when motor constants vary or when the wiring distance is long.

For the offline auto tuning under Vector control (for induction motor), refer to [page 532](#).

Pr.	Name	Initial value	Setting range	Description
684 C000	Tuning data unit switchover	0	0	Internal data converted value
			1	The value is indicated in A, Ω, mH, or mV.
71 C100	Applied motor	0	0 to 6, 13 to 16, 20, 23, 24, 30, 33, 34, 40, 43, 44, 50, 53, 54, 70, 73, 74, 330, 333, 334, 8090, 8093, 8094, 9090, 9093, 9094	By selecting a motor, the thermal characteristic and motor constant of each motor are set.
80 C101	Motor capacity	9999	0.4 to 55 kW <sup>*2</sup>	Set the applied motor capacity.
			0 to 3600 kW <sup>*3</sup>	
			9999	V/F control
81 C102	Number of motor poles	9999	2, 4, 6, 8, 10, 12	Set the number of motor poles.
			9999	V/F control
9 C103	Electronic thermal O/L relay	Inverter rated current <sup>*1</sup>	0 to 500 A <sup>*2</sup>	Set the rated motor current.
			0 to 3600 A <sup>*3</sup>	
83 C104	Rated motor voltage	200/400 V <sup>*4</sup>	0 to 1000 V	Set the rated motor voltage (V).
84 C105	Rated motor frequency	9999	10 to 400 Hz	Set the rated motor frequency (Hz).
			9999	As the internal data of the inverter is used, set it correctly according to the motor specifications.
702 C106	Maximum motor frequency	9999	0 to 400 Hz	Set the permissible speed (frequency) of the motor.
			9999	The <b>Pr.84</b> setting is used.
707 C107	Motor inertia (integer)	9999	10 to 999, 9999	Set the motor inertia.
724 C108	Motor inertia (exponent)	9999	0 to 7, 9999	9999: Inverter internal data
96 C110	Auto tuning setting/status	0	0	No offline auto tuning
			1	Offline auto tuning is performed without the motor rotating.
			11	Offline auto tuning is performed only for motor constant R1 (without motor rotation).
			101	Encoder position tuning and offline auto tuning are performed (with the motor rotating slightly).

Pr.	Name	Initial value	Setting range	Description	
90 C120	Motor constant (R1)	9999	0 to 50 Ω, 9999 <sup>*2*5</sup>	Tuning data (The value measured by offline auto tuning is automatically set.) 9999: Inverter internal data is used.	
			0 to 400 mΩ, 9999 <sup>*3*5</sup>		
92 C122	Motor constant (L1)/d-axis inductance (Ld)	9999	0 to 500 mH, 9999 <sup>*2*5</sup>		
			0 to 50 mH, 9999 <sup>*3*5</sup>		
93 C123	Motor constant (L2)/q-axis inductance (Lq)	9999	0 to 500 mH, 9999 <sup>*2*5</sup>		
			0 to 50 mH, 9999 <sup>*3*5</sup>		
859 C126	Torque current/Rated PM motor current	9999	0 to 500 A, 9999 <sup>*2*5</sup>		
			0 to 3600 A, 9999 <sup>*3*5</sup>		
706 C130	Induced voltage constant (phi f)	9999	0 to 5000 mV (rad/s) <sup>*5</sup>		Set this parameter according to the PM motor specifications.
			9999		The value calculated from the parameter setting for motor constant is used.
1412 C135	Motor induced voltage constant (phi f) exponent	9999	0 to 2	Set the exponent n when the induced voltage constant phi f (Pr.706) is multiplied by 10 <sup>n</sup> .	
			9999	No exponent setting	
711 C131	Motor Ld decay ratio	9999	0 to 100%, 9999	Tuning data (The value measured by offline auto tuning is automatically set.) 9999: Inverter internal data is used.	
712 C132	Motor Lq decay ratio	9999	0 to 100%, 9999		
725 C133	Motor protection current level	9999	100 to 500%	Set the maximum current (OCT) level of the motor.	
			9999	200%	
1002 C150	Lq tuning target current adjustment coefficient	9999	50 to 150%	Adjust the target current during tuning.	
			9999	100%	
450 C200	Second applied motor	9999	0, 1, 3 to 6, 13 to 16, 20, 23, 24, 30, 33, 34, 40, 43, 44, 50, 53, 54, 70, 73, 74, 330, 333, 334, 8090, 8093, 8094, 9090, 9093, 9094	Set this parameter when using the second motor (the same specifications as Pr.71).	
			9999	The function is disabled.	
453 C201	Second motor capacity	9999	0.4 to 55 kW <sup>*2</sup>	Set the capacity of the second motor.	
			0 to 3600 kW <sup>*3</sup>		
			9999	V/F control	
454 C202	Number of second motor poles	9999	2, 4, 6, 8, 10, 12	Set the number of poles of the second motor.	
			9999	V/F control	
51 C203	Second electronic thermal O/L relay	9999	0 to 500 A <sup>*2</sup>	Set the rated current of the second motor.	
			0 to 3600 A <sup>*3</sup>		
			9999	The second electronic thermal O/L relay is disabled.	
456 C204	Rated second motor voltage	200 V/ 400 V <sup>*4</sup>	0 to 1000 V	Set the rated voltage (V) of the second motor.	
457 C205	Rated second motor frequency	9999	10 to 400 Hz	Set the rated frequency (Hz) of the second motor.	
			9999	As the inverter internal data is used for the second motor, set it correctly according to the motor specifications.	
743 C206	Second motor maximum frequency	9999	0 to 400 Hz	Set the permissible speed (frequency) of the second motor.	
			9999	The Pr.457 setting is used.	
744 C207	Second motor inertia (integer)	9999	10 to 999, 9999	Set the motor inertia of the second motor.	
745 C208	Second motor inertia (exponent)	9999	0 to 7, 9999	9999: Inverter internal data	
463 C210	Second motor auto tuning setting/status	0	0	No auto tuning for the second motor.	
			1	Offline auto tuning is performed without the motor rotating.	
			11	Offline auto tuning is performed only for motor constant R1 (without motor rotation)	
			101	Encoder position tuning and offline auto tuning are performed (with the motor rotating slightly).	

Pr.	Name	Initial value	Setting range	Description	
458 C220	Second motor constant (R1)	9999	0 to 50 Ω, 9999 <sup>*2*5</sup>	Tuning data of the second motor. (The value measured by offline auto tuning is automatically set.) 9999: Inverter internal data is used.	
			0 to 400 mΩ, 9999 <sup>*3*5</sup>		
460 C222	Second motor constant (L1) / d-axis inductance (Ld)	9999	0 to 500 mH, 9999 <sup>*2*5</sup>		
			0 to 50 mH, 9999 <sup>*3*5</sup>		
461 C223	Second motor constant (L2) / q-axis inductance (Lq)	9999	0 to 500 mH, 9999 <sup>*2*5</sup>		
			0 to 50 mH, 9999 <sup>*3*5</sup>		
860 C226	Second motor torque current/Rated PM motor current	9999	0 to 500 A, 9999 <sup>*2*5</sup>		
			0 to 3600 A, 9999 <sup>*3*5</sup>		
738 C230	Second motor induced voltage constant (phi f)	9999	0 to 5000 mV (rad/s) <sup>*5</sup>		Set this parameter according to the PM motor specifications.
			9999		The value calculated from the parameter setting for motor constant is used.
1413 C235	Second motor induced voltage constant (phi f) exponent	9999	0 to 2	Set the exponent n when the induced voltage constant phi f (Pr.738) is multiplied by 10 <sup>n</sup> .	
			9999	No exponent setting	
739 C231	Second motor Ld decay ratio	9999	0 to 100%, 9999	Tuning data of the second motor. (The value measured by offline auto tuning is automatically set.) 9999: Inverter internal data is used.	
740 C232	Second motor Lq decay ratio	9999	0 to 100%, 9999		
746 C233	Second motor protection current level	9999	100 to 500%	Set the maximum current (OCT) level of the second motor.	
			9999	200%	
373 C142 <sup>*6</sup>	Encoder position tuning setting/status	0	0	Encoder position tuning disabled.	
			1	Encoder position tuning enabled.	
871 C243 <sup>*7</sup>	Control terminal option—Encoder position tuning setting/status	0	0	Encoder position tuning disabled.	
			1	Encoder position tuning enabled.	
1105 C143 <sup>*6</sup>	Encoder magnetic pole position offset	65535	0 to 16383	Encoder position tuning data set.	
			65535	Encoder position tuning not performed.	
887 C143 <sup>*7</sup>	Control terminal option—Encoder magnetic pole position offset	65535	0 to 16383	Encoder position tuning data set.	
			65535	Encoder position tuning not performed.	

\*1 For the FR-A820-00077(0.75K) or lower and FR-A840-00038(0.75K) or lower, it is set to 85% of the inverter rated current.

\*2 For the FR-A820-03160(55K) or lower, and FR-A840-01800(55K) or lower.

\*3 For the FR-A820-03800(75K) or higher, and FR-A840-02160(75K) or higher.

\*4 The initial value differs according to the voltage class (200 V / 400 V).

\*5 The setting range and unit change according to the Pr.71 (Pr.450) setting.

\*6 The setting is available when the FR-A8AL/FR-A8APR/FR-A8APS/FR-A8APA is installed.

\*7 The setting is available when the FR-A8TP is installed.

### Point

- Tuning is enabled even when a load is connected to the motor.
- Reading/writing of the motor constants tuned by offline auto tuning are enabled. The offline auto tuning data (motor constants) can be copied to another inverter using the operation panel.
- The offline auto tuning status can be monitored on the operation panel or the parameter unit.

## ◆ Before performing offline auto tuning

Check the following points before performing offline auto tuning:

- The Vector control is selected.
- Check that a motor is connected. (Check that the motor is not rotated by an external force during tuning.)
- The rated motor current should be equal to or less than the inverter rated current. (The motor capacity must be 0.4 kW or higher.)

If a motor with substantially low rated current compared with the inverter rated current, however, is used, speed and torque accuracies may deteriorate due to torque ripples, etc. Set the rated motor current to about 40% or higher of the inverter rated current.

- The maximum frequency is 400 Hz.

- The motor may rotate slightly even if the offline auto tuning without motor rotation (**Pr.96 Auto tuning setting/status = "1"**) is selected. (It does not affect the tuning performance.)  
Fix the motor securely with a mechanical brake, or before tuning, make sure that it is safe even if the motor rotates. (Caution is required especially in vertical lift applications.)
- Tuning is not available during position control.
- Tuning may be disabled depending on the motor characteristics.

## ◆ Settings

- To perform tuning, set the following parameters about the motor.

First motor Pr.	Second motor Pr.	Name	Setting value
80	453	Motor capacity	Motor capacity (kW)
81	454	Number of motor poles	Number of motor poles (2 to 12)
9	51	Electronic thermal O/L relay	Rated motor current (A)
84	457	Rated motor frequency	Rated motor frequency (Hz)
83	456	Rated motor voltage	Rated motor voltage (V)
71	450	Applied motor	8090, 8093 (IPM motor), 9090, 9093 (SPM motor) <sup>*1</sup>
96	463	Auto tuning setting/status	1, 101

\*1 Set **Pr.71 Applied motor** according to the motor to be used. According to the **Pr.71** setting, the range of the motor constant parameter setting values and units can be changed. (For other setting values of **Pr.71**, refer to [page 528](#).)

Motor	Pr.71 setting	
	Motor constant parameter $\Omega$ , mH, and A unit setting	Motor constant parameter internal data setting
IPM motor	8090	8093 (8094)
SPM motor	9090	9093 (9094)

- For tuning accuracy improvement, set the following parameters when the motor constants are known in advance.

First motor Pr.	Second motor Pr.	Name	Setting value
702	743	Maximum motor frequency	Maximum motor frequency (Hz)
707	744	Motor inertia (integer)	Motor inertia <sup>*1</sup>
724	745	Motor inertia (exponent)	$J_m = \text{Pr.707} \times 10^{(-\text{Pr.724})} \text{ (kg} \cdot \text{m}^2)$
725	746	Motor protection current level	Maximum current level of the motor (%)

\*1 The setting is valid only when a value other than "9999" is set in both **Pr.707 (Pr.744)** and **Pr.724 (Pr.745)**.

## ◆ Performing tuning

### Point

- Before performing tuning, check the monitor display of the operation panel or parameter unit if the inverter is in the state ready for tuning. The motor starts by turning ON the start command while tuning is unavailable.





- In the PU operation mode, press  /  on the operation panel.

For External operation, turn ON the start command (STF signal or STR signal). Tuning starts.

**NOTE**

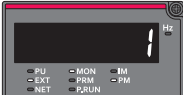
- Satisfy the required inverter start conditions to start offline auto tuning. For example, stop the input of the MRS signal.
- To force tuning to end, use the MRS or RES signal or  on the operation panel. (Turning OFF the start signal (STF signal or STR signal) also ends tuning.)
- During offline auto tuning, only the following I/O signals are valid (initial value).  
Input terminals <valid signals>: STP (STOP), OH, MRS, RT, RES, STF, STR, S1, and S2  
Output terminals: RUN, OL, IPF, FM/CA, AM, A1B1C1, and So (SO)
- When the rotation speed and the output frequency are selected for terminals FM/CA and AM, the progress status of offline auto tuning is output in 15 steps from FM/CA and AM.
- Do not perform ON/OFF switching of the Second function selection (RT) signal during offline auto tuning. Auto tuning will not be performed properly.
- A motor with 14 or more poles cannot be tuned.
- Since the Inverter running (RUN) signal turns ON when tuning is started, pay close attention especially when a sequence which releases a mechanical brake by the RUN signal has been designed.
- When executing offline auto tuning, input the operation command after switching ON the main circuit power (R/L1, S/L2, T/L3) of the inverter.
- While **Pr.79 Operation mode selection** = "7", turn ON the PU operation external interlock (X12) signal for tuning in the PU operation mode.
- Setting offline auto tuning (**Pr.96** = "1") will make pre-excitation invalid.

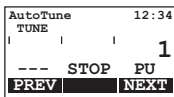
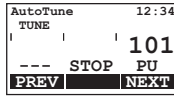
• During tuning, the monitor is displayed on the operation panel as follows.

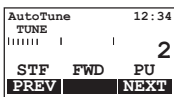
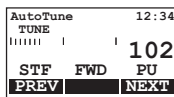
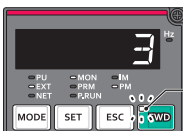
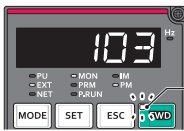
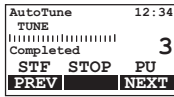
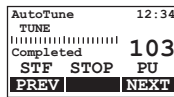
Pr.96 (Pr.463) setting	1		101	
	Operation panel (FR-DU08) display		LCD operation panel (FR-LU08) display	
(1) Setting				
(2) During tuning				
(3) Normal completion				

- When offline auto tuning ends, press  on the operation panel during PU operation. For External operation, turn OFF the start signal (STF signal or STR signal). This operation resets the offline auto tuning, and the PU's monitor display returns to the normal indication. (Without this operation, next operation cannot be started.)

**NOTE**

- The motor constants measured once during offline auto tuning are stored as parameters and their data are held until offline auto tuning is performed again. However, the tuning data is cleared when performing All parameter clear.
- Changing **Pr.71** after tuning completion will change the motor constant. For example, if the **Pr.71** setting is changed to "8093" after tuned with **Pr.71** = "8090", the tuning data become invalid. To use the tuned data, set "8090" again in **Pr.71**.



- If offline auto tuning has ended in error (see the following table), motor constants are not set. Perform an inverter reset and restart tuning.

Error display	Error cause	Countermeasures
8	Forced end	Set <b>Pr.96 (Pr.463)</b> ="1 or 101" and try again.
9	Inverter protective function operation	Make the setting again.
92	The converter output voltage fell to 75% of the rated voltage.	Check for the power supply voltage fluctuation. Check the <b>Pr.83 Rated motor voltage</b> setting.
93	Calculation error. The motor is not connected.	Check the motor wiring and make the setting again.
94	Rotation tuning frequency setting error. (The frequency command for the tuning was given to exceed the maximum frequency setting, or to be in the frequency jump range.)	Check the <b>Pr.1 Maximum frequency</b> and <b>Pr.31 to Pr.36 Frequency jump</b> settings.

- When tuning is ended forcibly by pressing  or turning OFF the start signal (STF or STR) during tuning, offline auto tuning does not end properly. (The motor constants have not been set.) Perform an inverter reset and perform tuning again.

#### NOTE

- An instantaneous power failure occurring during tuning will result in a tuning error. After power is restored, the inverter starts normal operation. Therefore, when the STF (STR) signal is ON, the motor starts forward (reverse) rotation.
- Any fault occurring during tuning is handled as in the normal operation. However, if the retry function is set, no retry is performed even when a protective function that performs a retry is activated.
- The set frequency monitor displayed during the offline auto tuning is 0 Hz.

#### CAUTION

- Note that the motor may start running suddenly.

### ◆ Parameters updated by tuning results after tuning

Pr.	Name	Tuning according to Pr.96 (Pr.463) setting			Description
		101	1	11	
90 (458)	Motor constant (R1)	○	○	○	Resistance per phase
92 (460)	Motor constant (L1)/d-axis inductance (Ld)	○	○	—	d-axis inductance
93 (461)	Motor constant (L2)/q-axis inductance (Lq)	○	○	—	q-axis inductance
711 (739)	Motor Ld decay ratio	○	○	—	d-axis inductance decay ratio
712 (740)	Motor Lq decay ratio	○	○	—	q-axis inductance decay ratio
859 (860)	Torque current/Rated PM motor current	○	○	—	
96 (463)	Auto tuning setting/status	○	○	○	
373 <sup>*1</sup>	871 <sup>*2</sup>	Encoder position tuning setting/status	○	—	Encoder position tuning status
1105 <sup>*1</sup>	887 <sup>*2</sup>	Encoder magnetic pole position offset	○	—	Turning data of encoder position tuning

○: Tuned, —: Not tuned

\*1 The setting is available when the FR-A8AL/FR-A8APR/FR-A8APS/FR-A8APA is installed.

\*2 The setting is available when the FR-A8TP is installed.

#### NOTE

- If the offline auto tuning is started before the encoder position tuning is finished (**Pr.1105 (Pr.887)** = "65535") for a PM motor, the protective function (E.MP) is activated.

### ◆ Tuning adjustment (Pr.1002)

- The overcurrent protective function may be activated during Lq tuning for an easily magnetically saturated motor (motor with a large Lq decay ratio). In such case, adjust the target flowing current used for tuning with **Pr.1002 Lq tuning target current adjustment coefficient**.



## ◆ Changing the motor constants

- The motor constants can be set directly when the motor constants are known in advance, or by using the data measured during offline auto tuning.
- According to the **Pr.71 (Pr.450)** setting, the range of the motor constant parameter setting values and units can be changed. The changed settings are stored in the EEPROM as the motor constant parameters.

## ◆ Changing the motor constants (when setting motor constants in units of Ω, mH, or A)

- Set **Pr.71** as follows.

Motor	Pr.71 setting
IPM motor	8090
SPM motor	9090

- Set desired values as the motor constant parameters.

First motor Pr.	Second motor Pr.	Name	Setting range	Setting increments	Initial value
90	458	Motor constant (R1)	0 to 50 Ω, 9999 <sup>*1</sup>	0.001 Ω <sup>*1</sup>	9999
			0 to 400 mΩ, 9999 <sup>*2</sup>	0.01 mΩ <sup>*2</sup>	
92	460	Motor constant (L1)/d-axis inductance (Ld)	0 to 500 mH, 9999 <sup>*1</sup>	0.01 mH <sup>*1</sup>	
			0 to 50 mH, 9999 <sup>*2</sup>	0.001 mH <sup>*2</sup>	
93	461	Motor constant (L2)/q-axis inductance (Lq)	0 to 500 mH, 9999 <sup>*1</sup>	0.01 mH <sup>*1</sup>	
			0 to 50 mH, 9999 <sup>*2</sup>	0.001 mH <sup>*2</sup>	
706	738	Induced voltage constant (phi f)	0 to 5000 mV (rad/s), 9999	0.1 mV (rad/s)	
859	860	Torque current/Rated PM motor current	0 to 500 A, 9999 <sup>*1</sup>	0.01 A <sup>*1</sup>	
			0 to 3600 A, 9999 <sup>*2</sup>	0.1 A <sup>*2</sup>	
1412	1413	Motor induced voltage constant (phi f) exponent	0 to 2, 9999	1	

\*1 For the FR-A820-03160(55K) or lower, and FR-A840-01800(55K) or lower.

\*2 For the FR-A820-03800(75K) or higher, and FR-A840-02160(75K) or higher.

### NOTE

- If "9999" is set, tuning data will be invalid and the inverter internal constant is used.
- To change a motor induced voltage constant of PM motors, the setting in **Pr.706 Induced voltage constant (phi f)** or **Pr.738 Second motor induced voltage constant (phi f)** must be changed. If the constant after the change exceeds the setting range of **Pr.706** or **Pr.738** (0 to 5000 mV (rad/s)), set **Pr.1412 Motor induced voltage constant (phi f) exponent** or **Pr.1413 Second motor induced voltage constant (phi f) exponent**. Set a value in the exponent n in the formula, **Pr.706 (Pr.738) × 10<sup>n</sup>** [mV (rad/s)], to set the induced voltage constant (phi f).
- When **Pr.71 (Pr.450)** = "8093, 8094, 9093, or 9094", or **Pr.1412 (Pr.1413)** = "9999", the motor induced voltage constant is as set in **Pr.706 (Pr.738)**. (No exponent setting)

## ◆ Changing the motor constants (when setting a motor constants in the internal data of the inverter)

- Set **Pr.71** as follows.

Motor	Pr.71 setting
IPM motor	8093 (8094)
SPM motor	9093 (9094)

- Set desired values as the motor constant parameters. The displayed increments of the read motor constants can be changed with **Pr.684 Tuning data unit switchover**. Setting **Pr.684** = "1" disables parameter setting changes.

First motor Pr.	Second motor Pr.	Name	Pr.684 = 0 (initial value)		Pr.684 = 1		Initial value
			Setting range	Setting increments	Setting range	Setting increments	
90	458	Motor constant (R1)	0 to ***, 9999	1	0 to 50 Ω, 9999 <sup>*1</sup>	0.001 Ω <sup>*1</sup>	9999
					0 to 400 mΩ, 9999 <sup>*2</sup>	0.01 mΩ <sup>*2</sup>	
92	460	Motor constant (L1)/d-axis inductance (Ld)			0 to 500 mH, 9999 <sup>*1</sup>	0.01 mH <sup>*1</sup>	
					0 to 50 mH, 9999 <sup>*2</sup>	0.001 mH <sup>*2</sup>	
93	461	Motor constant (L2)/q-axis inductance (Lq)			0 to 500 mH, 9999 <sup>*1</sup>	0.01 mH <sup>*1</sup>	
					0 to 50 mH, 9999 <sup>*2</sup>	0.001 mH <sup>*2</sup>	
706	738	Induced voltage constant (phi f)			0 to 5000 mV (rad/s), 9999	0.1 mV (rad/s)	
859	860	Torque current/Rated PM motor current			0 to 500 A, 9999 <sup>*1</sup>	0.01 A <sup>*1</sup>	
			0 to 3600 A, 9999 <sup>*2</sup>	0.1 A <sup>*2</sup>			
1412	1413	Motor induced voltage constant (phi f) exponent	0 to 2, 9999	1			

\*1 For the FR-A820-03160(55K) or lower, and FR-A840-01800(55K) or lower.

\*2 For the FR-A820-03800(75K) or higher, and FR-A840-02160(75K) or higher.

### NOTE

- As the motor constants measured in the offline auto tuning have been converted into internal data (\*\*\*\*), refer to the following setting example when making setting. (The value displayed has been converted into a value for internal use. Therefore, simple addition of a value to the displayed value does not bring the desired effect.)  
Setting example: to slightly increase the **Pr.90** value (5%)  
When "2516" is displayed for **Pr.90**, set 2642 (2516 × 1.05 = 2641.8) in **Pr.90**.
- If "9999" is set, tuning data will be invalid. The MM-CF constant is used for the IPM motor MM-CF, and the inverter internal constant is used for a PM motor other than MM-CF.
- To change a motor induced voltage constant of PM motors, the setting in **Pr.706 Induced voltage constant (phi f)** or **Pr.738 Second motor induced voltage constant (phi f)** must be changed. If the constant after the change exceeds the setting range of Pr.706 or Pr.738 (0 to 5000 mV (rad/s)), set **Pr.1412 Motor induced voltage constant (phi f) exponent** or **Pr.1413 Second motor induced voltage constant (phi f) exponent**. Set a value in the exponent n in the formula, **Pr.706 (Pr.738) × 10<sup>n</sup>** [mV (rad/s)], to set the induced voltage constant (phi f).
- When **Pr.71 (Pr.450)** = "8093, 8094, 9093, or 9094", or **Pr.1412 (Pr.1413)** = "9999", the motor induced voltage constant is as set in **Pr.706 (Pr.738)**. (No exponent setting)

## ◆ Encoder position tuning

Encoder position tuning is required when a PM motor with an encoder is driven. The measured offset value between the motor home magnetic pole position and the encoder home position is stored. Only encoder position tuning can be performed when offline auto tuning is not required, such as when the parameters for motor constant are set manually, or when offline auto tuning is already performed.

### ■ Before performing encoder position tuning

- Check that an option for vector control for PM motor, a motor, and an encoder are properly connected.
- Check that a motor (single, stop status) is connected. (Check that the motor is not rotated by an external force during tuning.)
- The mechanical brake is released.
- Check that the vector control (speed control) for the PM motor with an encoder is selected. (Refer to [page 221](#).)

### NOTE

- Encoder position tuning is required when a PM motor is used. (It is disabled when an induction motor is used.)
- When auto tuning is performed while **Pr.96** = "101", offline auto tuning and encoder position tuning can be performed at the same time.

## ■ Setting

- To perform tuning, set **Pr.373 (Pr.871)** = "1".

## ■ Performing tuning

### Point

- Before performing tuning, check the monitor display of the operation panel or parameter unit if the inverter is in the state ready for tuning. The motor starts by turning ON the start command while tuning is unavailable.

- In the PU operation mode, press  /  on the operation panel.

In the external operation mode, turn ON the start command (STF signal or STR signal). Tuning starts.

### NOTE

- The motor shaft rotates up to 2 times during tuning.

- During tuning, the monitor is displayed on the operation panel as follows.

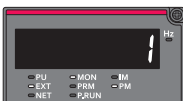
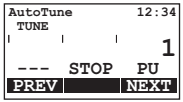
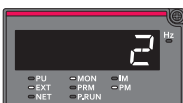
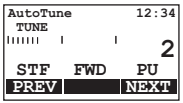
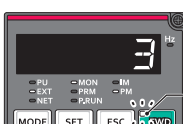
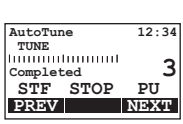
Status	Operation panel (FR-DU08) display	LCD operation panel (FR-LU08) display
(1) Setting		
(2) During tuning		
(3) Normal completion		

- When encoder position tuning ends, press  on the PU in the PU operation mode. For External operation, turn OFF the start signal (STF signal or STR signal). This operation resets encoder position tuning, and the PU's monitor display returns to the normal indication. (Without this operation, next operation cannot be started.)

### NOTE

- The encoder position tuning data is stored in **Pr.1105 (Pr.887)** until encoder position tuning is performed again. However, performing All parameter clear resets the tuning data.

- If encoder position tuning has ended in error (see the following table), motor constants are not set. Perform an inverter reset and perform tuning again.

Pr.373 (Pr.871) setting	Error cause	Countermeasures
8	Forced end	Set "1" in <b>Pr.373 (Pr.871)</b> and retry.
9	Inverter protective function operation	Identify and remove the cause of the protective function activation, and make the setting again.
93	The motor or the encoder is not connected.	Check the wiring of the motor and the encoder, the brake opening, and make the setting again.

- When tuning is ended forcibly by pressing  or turning OFF the start signal (STF or STR) during tuning, the tuning does not end properly. (The tuning data have not been set.) Perform an inverter reset and perform tuning again.

- When the protective function (E.EP) is activated during tuning, check the wiring of the motor and the encoder, **Pr.359 (Pr.852)** setting, and then perform tuning again.
- When tuning ends properly, the counter value of the offset between the motor home magnetic pole position and the encoder home position is written in **Pr.1105 (Pr.887)**.

#### Parameters referred to

Pr.9 Electronic thermal O/L relay [page 415](#)

Pr.71 Applied motor [page 528](#)

Pr.178 to Pr.189 (Input terminal function selection) [page 521](#)

Pr.800 Control method selection [page 221](#)

## 5.13.4 Offline auto tuning for a PM motor (motor constant tuning)

### PM

The offline auto tuning enables the optimal operation of a PM motor.

- Automatic measurement of motor constants (offline auto tuning) enables optimal operation of motors for PM sensorless vector control even when motor constants vary or when the wiring distance is long. IPM and SPM motors other than the MM-CF IPM motor can also be used.

For the offline auto tuning under Advanced magnetic flux vector control, Real sensorless vector control, and Vector control, refer to [page 532](#).

Pr.	Name	Initial value	Setting range	Description
684 C000	Tuning data unit switchover	0	0	Internal data converted value
			1	The value is indicated in A, Ω, mH, or mV.
71 C100	Applied motor	0	0 to 6, 13 to 16, 20, 23, 24, 30, 33, 34, 40, 43, 44, 50, 53, 54, 70, 73, 74, 330, 333, 334, 8090, 8093, 8094, 9090, 9093, 9094	By selecting a motor, the thermal characteristic and motor constant of each motor are set.
80 C101	Motor capacity	9999	0.4 to 55 kW <sup>*2</sup>	Set the applied motor capacity.
			0 to 3600 kW <sup>*3</sup>	
			9999	V/F control
81 C102	Number of motor poles	9999	2, 4, 6, 8, 10, 12	Set the number of motor poles.
			9999	V/F control
9 C103	Electronic thermal O/L relay	Inverter rated current <sup>*1</sup>	0 to 500 A <sup>*2</sup>	Set the rated motor current.
			0 to 3600 A <sup>*3</sup>	
83 C104	Rated motor voltage	200/400 V <sup>*4</sup>	0 to 1000 V	Set the rated motor voltage (V).
84 C105	Rated motor frequency	9999	10 to 400 Hz	Set the rated motor frequency (Hz).
			9999	The MM-CF constant is used when the IPM motor MM-CF is selected, and the inverter internal data is used when a PM motor other than MM-CF is selected. Use the correct setting according to the motor specification.
702 C106	Maximum motor frequency	9999	0 to 400 Hz	Set the permissible speed (frequency) of the motor.
			9999	The MM-CF motor maximum frequency is used when the IPM motor MM-CF is selected, and <b>Pr.84</b> setting is used when a PM motor other than MM-CF is selected.
707 C107	Motor inertia (integer)	9999	10 to 999, 9999	Set the motor inertia.
724 C108	Motor inertia (exponent)	9999	0 to 7, 9999	9999: The MM-CF inertia is used for the IPM motor MM-CF.
96 C110	Auto tuning setting/status	0	0, 101	No offline auto tuning
			1	Offline auto tuning is performed without rotating the motor (motor other than IPM motor MM-CF).
			11	Offline auto tuning is performed without rotating the motor (for IPM motor MM-CF).

Pr.	Name	Initial value	Setting range	Description	
90 C120	Motor constant (R1)	9999	0 to 50 Ω, 9999 <sup>*2*5</sup>	Tuning data (The value measured by offline auto tuning is automatically set.) 9999: The MM-CF constant is used when the IPM motor MM-CF is selected, and the inverter internal data is used when a PM motor other than MM-CF is selected.	
			0 to 400 mΩ, 9999 <sup>*3*5</sup>		
92 C122	Motor constant (L1)/d-axis inductance (Ld)	9999	0 to 500 mH, 9999 <sup>*2*5</sup>		
			0 to 50 mH, 9999 <sup>*3*5</sup>		
93 C123	Motor constant (L2)/q-axis inductance (Lq)	9999	0 to 500 mH, 9999 <sup>*2*5</sup>		
			0 to 50 mH, 9999 <sup>*3*5</sup>		
859 C126	Torque current/Rated PM motor current	9999	0 to 500 A, 9999 <sup>*2*5</sup>		
			0 to 3600 A, 9999 <sup>*3*5</sup>		
706 C130	Induced voltage constant (phi f)	9999	0 to 5000 mV (rad/s) <sup>*5</sup>		Set this parameter according to the PM motor specifications.
			9999		The value calculated from the parameter setting for motor constant is used.
1412 C135	Motor induced voltage constant (phi f) exponent	9999	0 to 2	Set the exponent n when the induced voltage constant phi f ( <b>Pr.706</b> ) is multiplied by 10 <sup>n</sup> .	
			9999	No exponent setting	
711 C131	Motor Ld decay ratio	9999	0 to 100%, 9999	Tuning data (The value measured by offline auto tuning is automatically set.) 9999: The MM-CF constant is used when the IPM motor MM-CF is selected, and the inverter internal data is used when a PM motor other than MM-CF is selected.	
712 C132	Motor Lq decay ratio	9999	0 to 100%, 9999		
717 C182	Starting resistance tuning compensation	9999	0 to 200%, 9999		
721 C185	Starting magnetic pole position detection pulse width	9999	0 to 6000 μs, 10000 to 16000 μs, 9999		
725 C133	Motor protection current level	9999	100 to 500%		Set the maximum current (OCT) level of the motor.
			9999	The MM-CF constant is used when the IPM motor MM-CF is selected, and 200% when a PM motor other than MM-CF is selected.	
1002 C150	Lq tuning target current adjustment coefficient	9999	50 to 150%	Adjust the target current during tuning.	
			9999	100%	
450 C200	Second applied motor	9999	0, 1, 3 to 6, 13 to 16, 20, 23, 24, 30, 33, 34, 40, 43, 44, 50, 53, 54, 70, 73, 74, 330, 333, 334, 8090, 8093, 8094, 9090, 9093, 9094	Set this parameter when using the second motor (the same specifications as <b>Pr.71</b> ).	
			9999	The function is disabled.	
453 C201	Second motor capacity	9999	0.4 to 55 kW <sup>*2</sup>	Set the capacity of the second motor.	
			0 to 3600 kW <sup>*3</sup>	V/F control	
454 C202	Number of second motor poles	9999	2, 4, 6, 8, 10, 12	Set the number of poles of the second motor.	
			9999	V/F control	
51 C203	Second electronic thermal O/L relay	9999	0 to 500 A <sup>*2</sup>	Set the rated current of the second motor.	
			0 to 3600 A <sup>*3</sup>	The second electronic thermal O/L relay is disabled.	
456 C204	Rated second motor voltage	200 V/ 400 V <sup>*4</sup>	0 to 1000 V	Set the rated voltage (V) of the second motor.	
457 C205	Rated second motor frequency	9999	10 to 400 Hz	Set the rated frequency (Hz) of the second motor.	
			9999	The MM-CF constant is used when the IPM motor MM-CF is selected for the second motor, and the inverter internal data is used when a PM motor other than MM-CF is selected. Use the correct setting according to the motor specification.	
743 C206	Second motor maximum frequency	9999	0 to 400 Hz	Set the permissible speed (frequency) of the second motor.	
			9999	The MM-CF motor maximum frequency is used when the MM-CF is selected, and <b>Pr.457</b> setting is used when a motor other than MM-CF is selected.	
744 C207	Second motor inertia (integer)	9999	10 to 999, 9999	Set the inertia of the second motor.	
745 C208	Second motor inertia (exponent)	9999	0 to 7, 9999	9999: The MM-CF inertia is used for the IPM motor MM-CF.	

Pr.	Name	Initial value	Setting range	Description	
463 C210	Second motor auto tuning setting/status	0	0, 101	No auto tuning for the second motor.	
			1	Offline auto tuning is performed without rotating the motor (motor other than IPM motor MM-CF).	
			11	Offline auto tuning is performed without rotating the motor (for IPM motor MM-CF).	
458 C220	Second motor constant (R1)	9999	0 to 50 Ω, 9999 <sup>*2*5</sup>	Tuning data of the second motor. (The value measured by offline auto tuning is automatically set.) 9999: The MM-CF constant is used when the IPM motor MM-CF is selected, and the inverter internal data is used when a PM motor other than MM-CF is selected.	
			0 to 400 mΩ, 9999 <sup>*3*5</sup>		
460 C222	Second motor constant (L1) / d-axis inductance (Ld)	9999	0 to 500 mH, 9999 <sup>*2*5</sup>		
			0 to 50 mH, 9999 <sup>*3*5</sup>		
461 C223	Second motor constant (L2) / q-axis inductance (Lq)	9999	0 to 500 mH, 9999 <sup>*2*5</sup>		
			0 to 50 mH, 9999 <sup>*3*5</sup>		
860 C226	Second motor torque current/Rated PM motor current	9999	0 to 500 A, 9999 <sup>*2*5</sup>		
			0 to 3600 A, 9999 <sup>*3*5</sup>		
738 C230	Second motor induced voltage constant (phi f)	9999	0 to 5000 mV (rad/s) <sup>*5</sup>		Set this parameter according to the PM motor specifications.
			9999		The value calculated from the parameter setting for motor constant is used.
1413 C235	Second motor induced voltage constant (phi f) exponent	9999	0 to 2	Set the exponent n when the induced voltage constant phi f (Pr.738) is multiplied by 10 <sup>n</sup> .	
			9999	No exponent setting	
739 C231	Second motor Ld decay ratio	9999	0 to 100%, 9999	Tuning data of the second motor. (The value measured by offline auto tuning is automatically set.) 9999: The MM-CF constant is used when the IPM motor MM-CF is selected, and the inverter internal data is used when a PM motor other than MM-CF is selected.	
740 C232	Second motor Lq decay ratio	9999	0 to 100%, 9999		
741 C282	Second starting resistance tuning compensation	9999	0 to 200%, 9999		
742 C285	Second motor magnetic pole detection pulse width	9999	0 to 6000 μs, 10000 to 16000 μs, 9999		
			100 to 500%		Set the maximum current (OCT) level of the second motor.
746 C233	Second motor protection current level	9999	9999	The MM-CF constant is used when the IPM motor MM-CF is selected, and 200% when a PM motor other than MM-CF is selected.	

\*1 For the FR-A820-00077(0.75K) or lower and FR-A840-00038(0.75K) or lower, it is set to 85% of the inverter rated current.

\*2 For the FR-A820-03160(55K) or lower, and FR-A840-01800(55K) or lower.

\*3 For the FR-A820-03800(75K) or higher, and FR-A840-02160(75K) or higher.

\*4 The initial value differs according to the voltage class (200 V / 400 V).

\*5 The setting range and unit change according to the Pr.71 (Pr.450) setting.

### Point

- The settings are valid under PM sensorless vector control.
- The offline auto tuning enables the operation with SPM motors and IPM motors other than MM-CF. (When a PM motor other than the IPM motor MM-CF is used, always perform offline auto tuning.)
- Tuning is enabled even when a load is connected to the motor.
- Reading/writing of the motor constants tuned by offline auto tuning are enabled. The offline auto tuning data (motor constants) can be copied to another inverter using the operation panel.
- The offline auto tuning status can be monitored on the operation panel or the parameter unit.

## ◆ Before performing offline auto tuning

Check the following points before performing offline auto tuning:

- Check that PM sensorless vector control is selected.
- Check that a motor is connected. (Check that the motor is not rotated by an external force during tuning.)

- The rated motor current should be equal to or less than the inverter rated current. (The motor capacity must be 0.4 kW or higher.)

If a motor with substantially low rated current compared with the inverter rated current, however, is used, speed and torque accuracies may deteriorate due to torque ripples, etc. Set the rated motor current to about 40% or higher of the inverter rated current.

- The maximum frequency under PM sensorless vector control is 400 Hz.
- The motor may rotate slightly even if offline auto tuning is performed without the motor rotating (**Pr.96 Auto tuning setting/status** = "1 or 11"). (It does not affect the tuning performance.)

Fix the motor securely with a mechanical brake, or before tuning, make sure that it is safe even if the motor rotates. (Caution is required especially in vertical lift applications.)

- Tuning is not available during position control under PM sensorless vector control.
- Tuning may be disabled depending on the motor characteristics.

## ◆ Settings

- To perform tuning, set the following parameters about the motor.

First motor Pr.	Second motor Pr.	Name	Setting for a PM motor other than MM-CF	Setting for MM-CF
80	453	Motor capacity	Motor capacity (kW)	Set by the IPM parameter initialization. (Refer to <a href="#">page 231</a> .)
81	454	Number of motor poles	Number of motor poles (2 to 12)	
9	51	Electronic thermal O/L relay	Rated motor current (A)	
84	457	Rated motor frequency	Rated motor frequency (Hz)	
83	456	Rated motor voltage	Rated motor voltage (V)	Initial value (200 V or 400 V)
71	450	Applied motor	8090, 8093 (IPM motor), 9090, 9093 (SPM motor) <sup>*1</sup>	330, 333 <sup>*1</sup>
96	463	Auto tuning setting/status	1	11

<sup>\*1</sup> Set **Pr.71 Applied motor** according to the motor to be used. According to the **Pr.71** setting, the range of the motor constant parameter setting values and units can be changed. (For other setting values of **Pr.71**, refer to [page 528](#).)

Motor		Pr.71 setting	
		Motor constant parameter $\Omega$ , mH, and A unit setting	Motor constant parameter internal data setting
IPM motor	MM-CF	330	333 (334)
	Other than MM-CF	8090	8093 (8094)
SPM motor		9090	9093 (9094)

### NOTE

- Under PM sensorless vector control, tuning cannot be performed even when **Pr.96** = "101". When the MM-CF is set to the applied motor, tuning cannot be performed even when **Pr.96** = "1 or 101".

- For tuning accuracy improvement, set the following parameters when the motor constants are known in advance.

First motor Pr.	Second motor Pr.	Name	Setting for a PM motor other than MM-CF	Setting for MM-CF
702	743	Maximum motor frequency	Maximum motor frequency (Hz)	9999 (initial value)
707	744	Motor inertia (integer)	Motor inertia <sup>*1</sup>	9999 (initial value)
724	745	Motor inertia (exponent)	$J_m = \text{Pr.707} \times 10^{(-\text{Pr.724})}$ (kg·m <sup>2</sup> )	
725	746	Motor protection current level	Maximum current level of the motor (%)	9999 (initial value)

<sup>\*1</sup> The setting is valid only when a value other than "9999" is set in both **Pr.707 (Pr.744)** and **Pr.724 (Pr.745)**.

## ◆ Performing tuning

### Point

- Before performing tuning, check the monitor display of the operation panel or parameter unit if the inverter is in the state ready for tuning. The motor starts by turning ON the start command while tuning is unavailable.





- In the PU operation mode, press  /  on the operation panel.

For External operation, turn ON the start command (STF signal or STR signal). Tuning starts.

**NOTE**

- Satisfy the required inverter start conditions to start offline auto tuning. For example, stop the input of the MRS signal.
- To force tuning to end, use the MRS or RES signal or  on the operation panel. (Turning OFF the start signal (STF signal or STR signal) also ends tuning.)
- During offline auto tuning, only the following I/O signals are valid (initial value).  
Input terminals <valid signals>: STP (STOP), OH, MRS, RT, RES, STF, STR, S1, and S2  
Output terminals: RUN, OL, IPF, FM/CA, AM, A1B1C1, and So (SO)
- When the rotation speed and the output frequency are selected for terminals FM/CA and AM, the progress status of offline auto tuning is output in 15 steps from FM/CA and AM.
- Do not perform ON/OFF switching of the Second function selection (RT) signal during offline auto tuning. Auto tuning will not be performed properly.
- A motor with 14 or more poles cannot be tuned.
- Since the Inverter running (RUN) signal turns ON when tuning is started, pay close attention especially when a sequence which releases a mechanical brake by the RUN signal has been designed.
- When executing offline auto tuning, input the operation command after switching ON the main circuit power (R/L1, S/L2, T/L3) of the inverter.
- While **Pr.79 Operation mode selection** = "7", turn ON the PU operation external interlock (X12) signal for tuning in the PU operation mode.
- Setting offline auto tuning (**Pr.96** = "1 or 11") will make pre-excitation invalid.

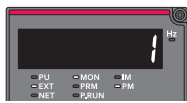
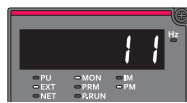
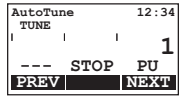
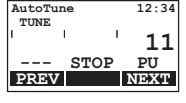
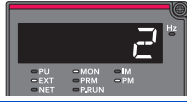
- During tuning, the monitor is displayed on the operation panel as follows.

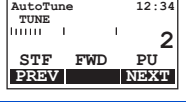
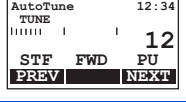
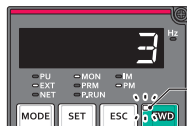
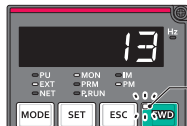
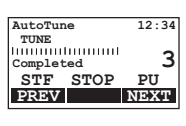
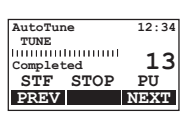
Pr.96 (Pr.463) setting	1		11	
	Operation panel (FR-DU08) display		LCD operation panel (FR-LU08) display	
(1) Setting				
(2) During tuning				
(3) Normal completion				

- When offline auto tuning ends, press  on the operation panel during PU operation. For External operation, turn OFF the start signal (STF signal or STR signal). This operation resets the offline auto tuning, and the PU's monitor display returns to the normal indication. (Without this operation, next operation cannot be started.)

**NOTE**

- The motor constants measured once during offline auto tuning are stored as parameters and their data are held until offline auto tuning is performed again. However, the tuning data is cleared when performing All parameter clear.
- Changing **Pr.71** after tuning completion will change the motor constant. For example, if the **Pr.71** setting is changed to "8093" after tuned with **Pr.71** = "8090", the tuning data become invalid. To use the tuned data, set "8090" again in **Pr.71**.



- If offline auto tuning has ended in error (see the following table), motor constants are not set.  
Perform an inverter reset and perform tuning again.

Error display	Error cause	Countermeasures
8	Forced end	Set <b>Pr.96 (Pr.463)</b> ="1 or 11" and try again.
9	Inverter protective function operation	Make the setting again.
92	The converter output voltage fell to 75% of the rated voltage.	Check for the power supply voltage fluctuation. Check the <b>Pr.83 Rated motor voltage</b> setting.
93	Calculation error. The motor is not connected.	Check the motor wiring and make the setting again.
94	Rotation tuning frequency setting error. (The frequency command for the tuning was given to exceed the maximum frequency setting, or to be in the frequency jump range.)	Check the <b>Pr.1 Maximum frequency</b> and <b>Pr.31 to Pr.36 Frequency jump</b> settings.

- When tuning is ended forcibly by pressing  or turning OFF the start signal (STF or STR) during tuning, offline auto tuning does not end properly. (The motor constants have not been set.)  
Perform an inverter reset and perform tuning again.

#### NOTE

- An instantaneous power failure occurring during tuning will result in a tuning error.  
After power is restored, the inverter starts normal operation. Therefore, when the STF (STR) signal is ON, the motor starts forward (reverse) rotation.
- Any fault occurring during tuning is handled as in the normal operation. However, if the retry function is set, no retry is performed even when a protective function that performs a retry is activated.
- The set frequency monitor displayed during the offline auto tuning is 0 Hz.

#### CAUTION

- Note that the motor may start running suddenly.

### ◆ Parameters updated by tuning results after tuning

First motor Pr.	Second motor Pr.	Name	Other than MM-CF Pr.96 (Pr.463) = 1	V/F control, MM-CF Pr.96 (Pr.463) = 11	Description
90	458	Motor constant (R1)	○	○	Resistance per phase
92	460	Motor constant (L1)/d-axis inductance (Ld)	○	—	d-axis inductance
93	461	Motor constant (L2)/q-axis inductance (Lq)	○	—	q-axis inductance
711	739	Motor Ld decay ratio	○	—	d-axis inductance decay ratio
712	740	Motor Lq decay ratio	○	—	q-axis inductance decay ratio
717	741	Starting resistance tuning compensation	○	○	
721	742	Starting magnetic pole position detection pulse width	○	—	When the setting value is 10000 or more: With polarity inversion for compensation, voltage pulse (Pr. setting minus 10000) μs
859	860	Torque current/Rated PM motor current	○	—	
96	463	Auto tuning setting/status	○	○	

### ◆ Tuning adjustment (Pr.1002)

- The overcurrent protective function may be activated during Lq tuning for an easily magnetically saturated motor (motor with a large Lq decay ratio). In such case, adjust the target flowing current used for tuning with **Pr.1002 Lq tuning target current adjustment coefficient**.

### ◆ Changing the motor constants

- The motor constants can be set directly when the motor constants are known in advance, or by using the data measured during offline auto tuning.

- According to the **Pr.71 (Pr.450)** setting, the range of the motor constant parameter setting values and units can be changed. The changed settings are stored in the EEPROM as the motor constant parameters.

## ◆ Changing the motor constants (when setting motor constants in units of Ω, mH, or A)

- Set **Pr.71** as follows.

Motor		Pr.71 setting
IPM motor	MM-CF	330
	Other than MM-CF	8090
SPM motor		9090

- Set desired values as the motor constant parameters.

First motor Pr.	Second motor Pr.	Name	Setting range	Setting increments	Initial value
90	458	Motor constant (R1)	0 to 50 Ω, 9999 <sup>*1</sup>	0.001 Ω <sup>*1</sup>	9999
			0 to 400 mΩ, 9999 <sup>*2</sup>	0.01 mΩ <sup>*2</sup>	
92	460	Motor constant (L1)/d-axis inductance (Ld)	0 to 500 mH, 9999 <sup>*1</sup>	0.01 mH <sup>*1</sup>	
			0 to 50 mH, 9999 <sup>*2</sup>	0.001 mH <sup>*2</sup>	
93	461	Motor constant (L2)/q-axis inductance (Lq)	0 to 500 mH, 9999 <sup>*1</sup>	0.01 mH <sup>*1</sup>	
			0 to 50 mH, 9999 <sup>*2</sup>	0.001 mH <sup>*2</sup>	
706	738	Induced voltage constant (phi f)	0 to 5000 mV (rad/s), 9999	0.1 mV (rad/s)	
859	860	Torque current/Rated PM motor current	0 to 500 A, 9999 <sup>*1</sup>	0.01 A <sup>*1</sup>	
			0 to 3600 A, 9999 <sup>*2</sup>	0.1 A <sup>*2</sup>	
1412	1413	Motor induced voltage constant (phi f) exponent	0 to 2, 9999	1	

\*1 For the FR-A820-03160(55K) or lower, and FR-A840-01800(55K) or lower.

\*2 For the FR-A820-03800(75K) or higher, and FR-A840-02160(75K) or higher.

### NOTE

- If "9999" is set, tuning data will be invalid. The MM-CF constant is used for the IPM motor MM-CF, and the inverter internal constant is used for a PM motor other than MM-CF.
- To change a motor induced voltage constant of PM motors, the setting in **Pr.706 Induced voltage constant (phi f)** or **Pr.738 Second motor induced voltage constant (phi f)** must be changed. If the constant after the change exceeds the setting range of **Pr.706** or **Pr.738** (0 to 5000 mV (rad/s)), set **Pr.1412 Motor induced voltage constant (phi f) exponent** or **Pr.1413 Second motor induced voltage constant (phi f) exponent**. Set a value in the exponent n in the formula, **Pr.706 (Pr.738) × 10<sup>n</sup> [mV (rad/s)]**, to set the induced voltage constant (phi f).
- When **Pr.71 (Pr.450)** = "8093, 8094, 9093, or 9094", or **Pr.1412 (Pr.1413)** = "9999", the motor induced voltage constant is as set in **Pr.706 (Pr.738)**. (No exponent setting)

## ◆ Changing the motor constants (when setting a motor constants in the internal data of the inverter)

- Set **Pr.71** as follows.

Motor		Pr.71 setting
IPM motor	MM-CF	333 (334)
	Other than MM-CF	8093 (8094)
SPM motor		9093 (9094)

- Set desired values as the motor constant parameters. The displayed increments of the read motor constants can be changed with **Pr.684 Tuning data unit switchover**. Setting **Pr.684 = "1"** disables parameter setting changes.

First motor Pr.	Second motor Pr.	Name	Pr.684 = 0 (initial value)		Pr.684 = 1		Initial value
			Setting range	Setting increments	Setting range	Setting increments	
90	458	Motor constant (R1)	0 to ***, 9999	1	0 to 50 Ω, 9999 <sup>*1</sup>	0.001 Ω <sup>*1</sup>	9999
					0 to 400 mΩ, 9999 <sup>*2</sup>	0.01 mΩ <sup>*2</sup>	
92	460	Motor constant (L1)/d-axis inductance (Ld)			0 to 500 mH, 9999 <sup>*1</sup>	0.01 mH <sup>*1</sup>	
					0 to 50 mH, 9999 <sup>*2</sup>	0.001 mH <sup>*2</sup>	
93	461	Motor constant (L2)/q-axis inductance (Lq)			0 to 500 mH, 9999 <sup>*1</sup>	0.01 mH <sup>*1</sup>	
					0 to 50 mH, 9999 <sup>*2</sup>	0.001 mH <sup>*2</sup>	
706	738	Induced voltage constant (phi f)			0 to 5000 mV (rad/s), 9999	0.1 mV (rad/s)	
859	860	Torque current/Rated PM motor current			0 to 500 A, 9999 <sup>*1</sup>	0.01 A <sup>*1</sup>	
			0 to 3600 A, 9999 <sup>*2</sup>	0.1 A <sup>*2</sup>			
1412	1413	Motor induced voltage constant (phi f) exponent	0 to 2, 9999	1			

\*1 For the FR-A820-03160(55K) or lower, and FR-A840-01800(55K) or lower.

\*2 For the FR-A820-03800(75K) or higher, and FR-A840-02160(75K) or higher.

## NOTE

- As the motor constants measured in the offline auto tuning have been converted into internal data (\*\*\*\*), refer to the following setting example when making setting. (The value displayed has been converted into a value for internal use. Therefore, simple addition of a value to the displayed value does not bring the desired effect.)  
Setting example: to slightly increase the **Pr.90** value (5%)  
When "2516" is displayed for **Pr.90**, set 2642 ( $2516 \times 1.05 = 2641.8$ ) in **Pr.90**.
- If "9999" is set, tuning data will be invalid. The MM-CF constant is used for the IPM motor MM-CF, and the inverter internal constant is used for a PM motor other than MM-CF.
- To change a motor induced voltage constant of PM motors, the setting in **Pr.706 Induced voltage constant (phi f)** or **Pr.738 Second motor induced voltage constant (phi f)** must be changed. If the constant after the change exceeds the setting range of Pr.706 or Pr.738 (0 to 5000 mV (rad/s)), set **Pr.1412 Motor induced voltage constant (phi f) exponent** or **Pr.1413 Second motor induced voltage constant (phi f) exponent**. Set a value in the exponent n in the formula, **Pr.706 (Pr.738) × 10<sup>n</sup>** [mV (rad/s)], to set the induced voltage constant (phi f).
- When **Pr.71 (Pr.450) = "8093, 8094, 9093, or 9094"**, or **Pr.1412 (Pr.1413) = "9999"**, the motor induced voltage constant is as set in **Pr.706 (Pr.738)**. (No exponent setting)

## Parameters referred to

**Pr.9 Electronic thermal O/L relay** [page 415](#)

**Pr.71 Applied motor** [page 528](#)

**Pr.178 to Pr.189 (Input terminal function selection)** [page 521](#)

**Pr.800 Control method selection** [page 221](#)

## 5.13.5 Online auto tuning

Magnetic flux Sensorless Vector

If online auto tuning is selected under Advanced magnetic flux vector control, Real sensorless vector control, or Vector control, favorable torque accuracy is retained by adjusting temperature even when the resistance value varies due to increase in the motor temperature.

Pr.	Name	Initial value	Setting range	Description
<b>95</b> <b>C111</b>	<b>Online auto tuning selection</b>	0	0	No online auto tuning
			1	Online auto tuning is performed at startup.
			2	Magnetic flux observer (continuous tuning)
<b>574</b> <b>C211</b>	<b>Second motor online auto tuning</b>	0	0 to 2	Select online auto tuning for the second motor. (The settings are the same as those in <b>Pr.95</b> .)

### ◆ Online auto tuning at startup (Pr.95/Pr.574 = "1")

- By promptly tuning the motor status at startup, accurate operation without being affected by motor temperature is achieved. Also high torque can be provided at very low speed and stable operation is possible.

- Under Advanced magnetic flux vector control (**Pr.80 Motor capacity, Pr.81 Number of motor poles**) or Real sensorless vector control (**Pr.80, Pr.81, Pr.800 Control method selection**), select the online auto tuning at start.
- Make sure to perform offline auto tuning before performing online auto tuning.

## Operating procedure

1. Perform offline auto tuning. (Refer to [page 532](#).)
2. Check that **Pr.96 Auto tuning setting/status** = "3 or 103" (offline auto tuning completion).
3. Set **Pr.95 Online auto tuning selection** = "1" (online auto tuning at start).  
Online auto tuning is enabled at the next start.
4. Check that the following parameters are set before starting operation.

Pr.	Description
9	Rated motor current or electronic thermal O/L relay
71	Applied motor
80	Motor capacity (with the rated motor current equal to or less than the inverter rated current) <sup>*1</sup>
81	Number of motor poles

<sup>\*1</sup> If a motor with substantially low rated current compared with the inverter rated current is used, speed and torque accuracies may deteriorate due to torque ripples, etc. Set the rated motor current to about 40% or higher of the inverter rated current.

5. In the PU operation mode, press  /  on the operation panel.  
For External operation, turn ON the start command (STF signal or STR signal).

### NOTE

- When performing the online auto tuning at start for a lift, consider using a brake sequence function for the brake opening timing at a start, or tuning using the external terminal. The tuning takes about 500 ms at the most after starting. However, during this time, it is possible that not enough torque is provided and caution is required to prevent the object from dropping. Use of the Start-time tuning start external input (X28) signal is recommended to perform tuning. (Refer to [page 559](#).)
- Perform online auto tuning at startup when the motor is stopped.
- The online auto tuning is disabled when the MRS signal is being input, the setting speed is **Pr.13 Starting frequency** or lower (V/F control, Advanced magnetic flux vector control), an inverter fault is occurring, or the inverter's startup condition is not satisfied.
- Online auto tuning does not operate during deceleration and restart from DC injection brake operation.
- It is disabled during JOG operation.
- If automatic restart after instantaneous power failure is selected, automatic restart is prioritized. (Online auto tuning at startup is not performed during frequency search.)  
If automatic restart after instantaneous power failure is used together, perform online auto tuning while stopping operation with the X28 signal. (Refer to [page 559](#).)
- Zero current detection and output current detection are enabled during online auto tuning.
- The RUN signal is not output during online auto tuning. The RUN signal is turned ON at operation startup.
- If the time between the inverter stop and restart is within 4 seconds, tuning is performed at startup but its result will not be applied.

## ◆ Online auto tuning at startup using the external terminal (Pr.95/Pr.574 = "1", X28 signal, Y39 signal)

- Before turning ON the start signal (STF or STR), online auto tuning can be performed by turning ON the Start-time tuning start external input (X28) signal in a stopped status in order to minimize the startup delay by tuning at start.
- Perform offline auto tuning and set "1" (tuning at start) in **Pr.95**.
- When the Start time tuning completion (Y39) signal is OFF, tuning at start can be performed with the X28 signal.
- The tuning takes about 500 ms at the most.
- To use the X28 signal, set "28" in any of **Pr.178 to Pr.189 (Input terminal function selection)** to assign the function to an input terminal.

- To use the Y39 signal, set "39 (positive logic) or 139 (negative logic)" in any of **Pr.190 to Pr.196 (Output terminal function selection)** to assign the function to an output terminal.

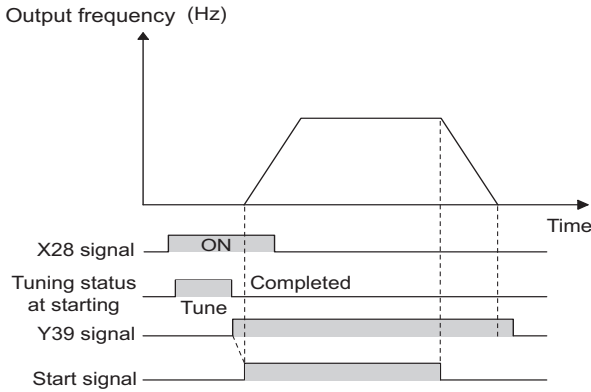

While the motor is stopped

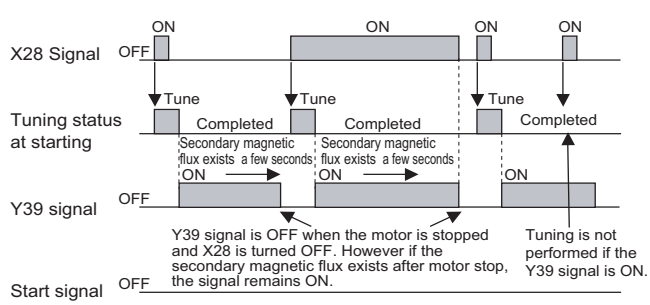

While the X28 signal is OFF

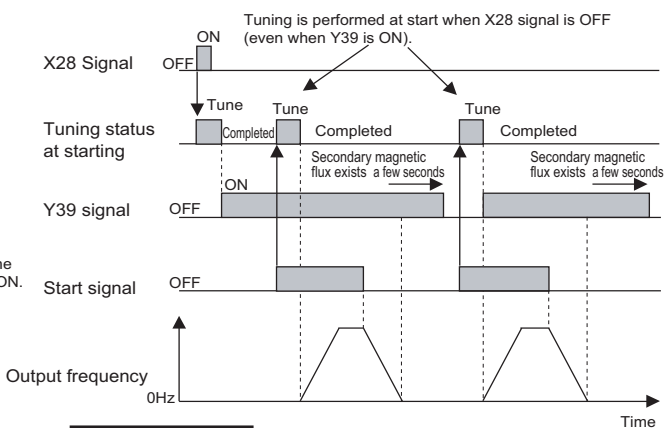

While the X28 signal is ON

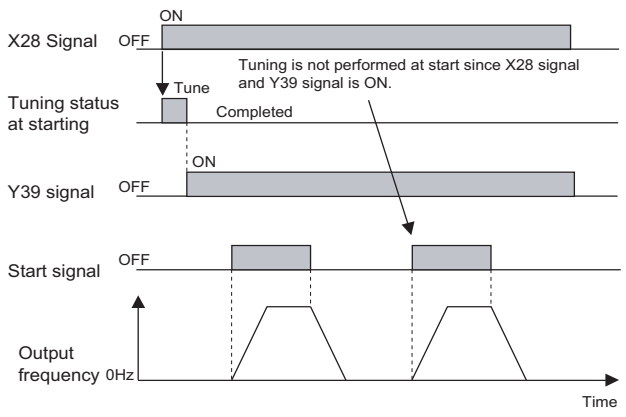

Switching motor

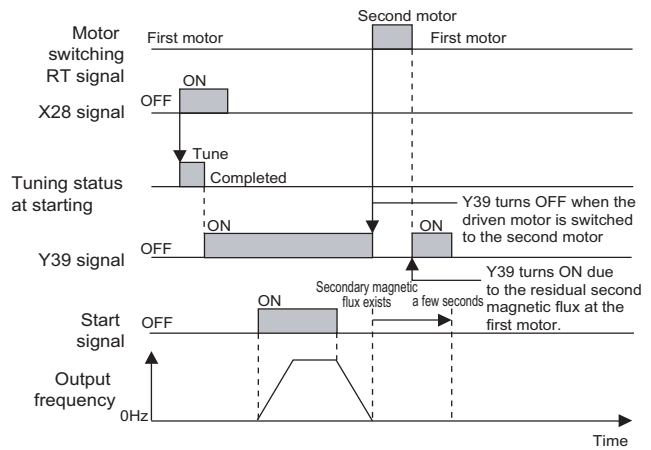

**NOTE**

- Even if the start signal is turned ON during zero speed control or servo lock, tuning is performed at startup.
- The Y39 signal remains ON after the motor is stopped as long as the second flux remains.
- The X28 signal is disabled while the Y39 signal is ON.
- The STF and STR signals are enabled after completing tuning at start.
- The Inverter running (RUN) signal is not turned ON during online auto tuning. The RUN signal is turned ON after starting up.
- This function is disabled under V/F control or PM sensorless vector control.
- Changing the terminal assignment using **Pr.178 to Pr.189 (Input terminal function selection)** or **Pr.190 to Pr.196 (Output terminal function selection)** may affect the other functions. Set parameters after confirming the function of each terminal.

## ◆ Magnetic flux observer (continuous tuning) (Pr.95/Pr.574 = "2")

- Performing Vector control with a motor with encoder improves the torque accuracy. Estimate or measure the flux within the motor using the current running through the motor and the inverter output voltage. Since the flux of a motor can be accurately estimated continuously (even during operation), optimum characteristics can be obtained without being affected by temperature change in the second resistor.
- Under Vector control (**Pr.80, Pr.81, Pr.800**), select the magnetic flux observer.

### NOTE

- Offline auto tuning is not necessary when magnetic flux observer is selected for SF-V5RU, SF-JR (with encoder), SF-HR (with encoder), SF-JRCA (with encoder) or SF-HRCA (with encoder). (However, when the wiring length is long (30 m or longer as a reference), perform offline auto tuning so that the resistance arises in the long wiring can be reflected to the operation.)

## ◆ Tuning the second motor (Pr.574)

- When one inverter switches the operation between two different motors, set the second motor in **Pr.450 Second applied motor**. (In the initial setting, no second motor is applied. (Refer to [page 528](#).)
- Perform tuning using **Pr.574 Second motor online auto tuning**.
- Pr.574** is enabled when the Second function selection (RT) signal is turned ON.

Pr.	Description
450	Applied motor
453	Motor capacity (with the rated motor current equal to or less than the inverter rated current) <sup>*1</sup>
454	Number of motor poles

\*1 If a motor with substantially low rated current compared with the inverter rated current is used, speed and torque accuracies may deteriorate due to torque ripples, etc. Set the rated motor current to about 40% or higher of the inverter rated current.

### NOTE

- The RT signal is the Second function selection signal. The RT signal also enables other second functions. (Refer to [page 521](#).) The RT signal is assigned to terminal RT in the initial status. Set "3" in one of **Pr.178 to Pr.189 (Input terminal function selection)** to assign the RT signal to another terminal.
- Changing the terminal assignment using **Pr.178 to Pr.189 (Input terminal function selection)** may affect the other functions. Set parameters after confirming the function of each terminal.

### Parameters referred to

Pr.9 Electronic thermal O/L relay [page 415](#)  
 Pr.71 Applied motor [page 528](#)  
 Pr.80 Motor capacity [page 221](#), [page 532](#), [page 551](#)  
 Pr.81 Number of motor poles [page 221](#), [page 532](#), [page 551](#)  
 Pr.96 Auto tuning setting/status [page 532](#), [page 551](#)  
 Pr.178 to Pr.189 (Input terminal function selection) [page 521](#)  
 Pr.190 to Pr.196 (Output terminal function selection) [page 473](#)  
 Pr.800 Control method selection [page 221](#)

## 5.13.6 Signal loss detection of encoder signals



Signal loss detection (E.ECT) is turned ON to shut off the inverter output when the encoder signal is lost during encoder feedback control or orientation control operation or under Vector control.

Signal loss detection (E.ECA) is activated to shut off the inverter output when the machine end encoder signal is lost during machine end orientation control.

Pr.	Name	Initial value	Setting range	Description
376 C148 <sup>*1</sup>	855 C248 <sup>*2</sup> Encoder signal loss detection enable/disable selection	0	0	Signal loss detection disabled
			1	Signal loss detection enabled

\*1 The setting is available when a Vector control compatible plug-in option is installed.

\*2 These parameters are available when the control terminal option (FR-A8TP) is installed.

## 5.14 (A) Application parameters

Purpose	Parameter to set			Refer to page
To operate by switching between the inverter and the commercial power supply operation	Electronic bypass function	P.A000 to P.A005	Pr.135 to Pr.139, Pr.159	563
To reduce the standby power	Self power management	P.A002, P.A006, P.A007, P.E300	Pr.30, Pr.137, Pr.248, Pr.254	569
To stop the motor with a mechanical brake (operation timing of mechanical brake)	Brake sequence function	P.A100 to P.A106, P.F500, P.A108, P.A109, P.A120 to P.A130	Pr.278 to Pr.285, Pr.292, Pr.639 to Pr.651	572
To count the number of inverter starting times	Start count monitor	P.A170, P.A171	Pr.1410, Pr.1411	576
To stop the motor with a mechanical brake (vibration control at stop-on-contact)	Stop-on-contact control	P.A200, P.A205, P.A206	Pr.270, Pr.275, Pr.276	577
To increase the speed at light load	Load torque high-speed frequency control	P.D301, P.D302, P.A200 to P.A204	Pr.4, Pr.5, Pr.270 to Pr.274	580
To strengthen or weaken the frequency at a constant cycle	Traverse operation	P.A300 to P.A305	Pr.592 to Pr.597	582
To suppress the swinging of an object moved by crane control	Anti-sway control	P.A310 to P.A317	Pr.1072 to Pr.1079	584
To adjust the stop position (orientation control) of the rotating shaft	Orientation control	P.A510 to P.A512, P.A520, P.A524, P.A525, P.A526 to P.A533, P.A540 to P.A545, P.C140, P.C141	Pr.350 to Pr.366, Pr.369, Pr.393 to Pr.399	585
To perform process control, such as for the pump flow volume and air volume	PID control	P.A601 to P.A607, P.A610 to P.A615, P.A621 to P.A625, P.A640 to P.A644, P.A650 to P.A655, P.A661 to P.A665	Pr.127 to Pr.134, Pr.553, Pr.554, Pr.575 to Pr.577, Pr.609, Pr.610, Pr.753 to Pr.758, Pr.1015, Pr.1134, Pr.1135, Pr.1140, Pr.1141, Pr.1143 to Pr.1149	601
	PID Pre-charge function	P.A616 to P.A620, P.A656 to P.A660	Pr.760 to Pr.769	618
	PID display adjustment	P.A600, P.A630 to P.A633, P.A670 to P.A673	Pr.759, C42 to C45 (Pr.934, Pr.935), Pr.1136 to Pr.1139	615
To control the dance roll for winding/unwinding	Dancer control	P.A601, P.A602, P.A605, P.A606, P.A610, P.A611, P.A613 to P.A615, P.A624, P.A625, P.F020, P.F021	Pr.44, Pr.45, Pr.128 to Pr.134, Pr.609, Pr.610, Pr.1134, Pr.1135	622
To continue operating at analog current input loss	4 mA input check	P.A680 to P.A682	Pr.573, Pr.777, Pr.778	517
To restart without stopping the motor at instantaneous power failure	Automatic restart after instantaneous power failure / flying start function for induction motors	P.A700 to P.A705, P.A710 to P.F003	Pr.57, Pr.58, Pr.162 to Pr.165, Pr.299, Pr.611	628
	Frequency search accuracy improvement (V/F control, offline auto tuning)	P.A700, P.A711, P.A712, P.C110, P.C210	Pr.96, Pr.162, Pr.298, Pr.463, Pr.560	638
	Automatic restart after instantaneous power failure / flying start function for IPM motors	P.A700, P.A702, P.F003	Pr.57, Pr.162, Pr.611	635
To decelerate the motor to a stop at power failure	Power failure time deceleration-to-stop function	P.A730 to P.A735, P.A785	Pr.261 to Pr.266, Pr.294	642



Purpose	Parameter to set			Refer to page
To operate with sequence program	PLC function	P.A800 to P.A805, P.A811 to P.A859	Pr.414 to Pr.417, Pr.498, Pr.675, Pr.1150 to Pr.1199	646
To store the inverter running status to a USB memory device	Trace function	P.A900 to P.A906, P.A910 to P.A920, P.A930 to P.A939	Pr.1020 to Pr.1047	649

## 5.14.1 Electronic bypass function



The inverter contains complicated sequence circuits for switching between the commercial power supply operation and inverter operation. Therefore, interlock operation of the magnetic contactor for switching can be easily performed by simply inputting start, stop, and automatic switching selection signals.

Pr.	Name	Initial value	Setting range	Description
57 A702	Restart coasting time	9999	0	Coasting time differs according to the inverter capacity.*1
			0.1 to 30 s	Set the delay time for the inverter to perform a restart after restoring power due to an instantaneous power failure.
			9999	No restart
58 A703	Restart cushion time	1 s	0 to 60 s	Set the voltage cushion time for restart.
135 A000	Electronic bypass sequence selection	0	0	Electronic bypass sequence function disabled.
			1	Electronic bypass sequence function enabled.
136 A001	MC switchover interlock time	1 s	0 to 100 s	Set the operation interlock time for MC2 and MC3.
137 A002	Start waiting time	0.5 s	0 to 100 s	Set a time period that is a little longer than the time period from the ON signal input to the actual pick-up operation of MC3 (0.3 to 0.5 s).
138 A003	Bypass selection at a fault	0	0	Inverter output stop (motor coasting) at inverter failure
			1	Automatic switchover to commercial power supply operation at inverter failure. (Switchover is not possible when an external thermal relay (E.OHT) or CPU fault (E.CPU) is occurring.)
139 A004	Automatic switchover frequency from inverter to bypass operation	9999	0 to 60 Hz	Set the frequency where the inverter operation is switched to commercial power supply operation. The inverter operation is performed from a start to <b>Pr.139</b> setting, then it switches automatically to the commercial power supply operation when the output frequency is equal to or above <b>Pr.139</b> .
			8888	When the FR-A8AVP is installed, the phase-synchronized bypass switching function is enabled. (For details, refer to the FR-A8AVP Instruction Manual.) When the FR-A8AVP is not installed, the operation is the same as the one when the setting is "9999".
			9999	Automatic bypass switching disabled
159 A005	Automatic switchover frequency range from bypass to inverter operation	9999	0 to 10 Hz	Set the frequency where the commercial power supply operation, which has been switched from the inverter operation with <b>Pr.139</b> , switches back to inverter operation. When the frequency command becomes less than ( <b>Pr.139</b> - <b>Pr.159</b> ), the motor switches automatically to inverter operation and operates at the frequency of the frequency command. Turning OFF a inverter start command (STF/STR) also switches the operation to the inverter operation.
			9999	To switch the commercial power supply operation, which has been switched from the inverter operation with <b>Pr.139</b> , to the inverter operation again, the inverter start command (STF/STR) is turned OFF. The operation switches to the inverter operation, and the motor decelerates to a stop.

\*1 The coasting time when **Pr.57** = "0" is as shown below. (When **Pr.162 Automatic restart after instantaneous power failure selection** is set to the initial value.)

FR-A820-00105(1.5K) or lower and FR-A840-00052(1.5K) or lower: 0.5 s

FR-A820-00167(2.2K) to FR-A820-00490(7.5K), FR-A840-00083(2.2K) to FR-A840-00250(7.5K): 1 s

FR-A820-00630(11K) to FR-A820-03160(55K), FR-A840-00310(11K) to FR-A840-01800(55K): 3.0 s

FR-A820-03800(75K) or higher, FR-A840-02160(75K) or higher: 5.0 s



## ◆ Electronic bypass sequence function

- When operating the motor at 60 Hz (or 50 Hz), the motor can be more efficiently operated with a commercial power supply. In addition, if the motor cannot be stopped for a long period of time even for an inverter maintenance and inspection, it is recommended that a commercial power supply circuit be installed.
- When switching between inverter operation and commercial power supply operation, commercial power supply may be accidentally applied to the output side of the inverter. To avoid such situation, provide an interlock where the magnetic contactor at the commercial power supply side turns ON at turn OFF of the magnetic contactor at the inverter output side. The inverter's electronic bypass sequence that outputs timing signals for the magnetic contactors can act as a complicated interlock between the commercial power supply operation and the inverter operation.

### NOTE

- The commercial power supply operation is not available with Mitsubishi Electric Vector control dedicated motors (SF-V5RU).

## ◆ Connection diagram

- A typical connection diagram of the electronic bypass sequence is shown below.

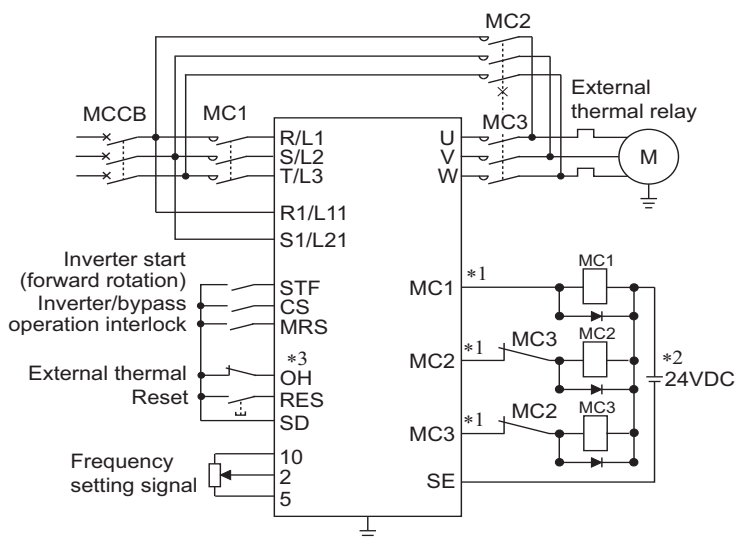

Standard models and IP55 compatible models

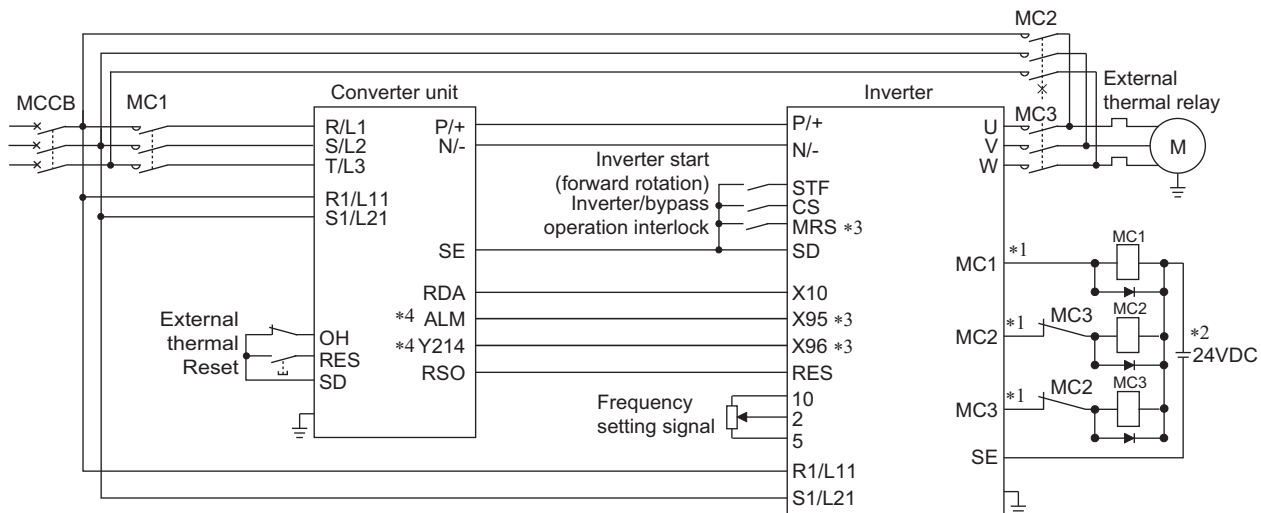

Separated converter type

- \*1 Be careful of the capacity of the sequence output terminals.  
The applied terminals differ by the settings of **Pr.190 to Pr.196 (Output terminal function selection)**.

Output terminal capacity	Output terminal permissible load
Open collector output of inverter (RUN, SU, IPF, OL, FU)	24 VDC 0.1 A
Inverter relay output (A1-C1, B1-C1, A2-B2, B2-C2)	230 VAC 0.3 A
Relay output option (FR-A8AR)	30 VDC 0.3 A

- \*2 When connecting a DC power supply, insert a protective diode.  
When connecting an AC power supply, use the relay output option (FR-A8AR), and use contact outputs.
- \*3 The applied terminals differ by the settings of **Pr.180 to Pr.189 (Input terminal function selection)**
- \*4 To use the signal, assign the function to the output terminal **Pr.190 to Pr.195 (Output terminal function selection)** of the converter unit. Always set the negative logic for the ALM signal.

## NOTE

- To use the electronic bypass function, the wiring terminals R1/L11 and S1/L21 must be connected to a separate power source that does not go through MC1. Be sure to connect using a separate power supply.
- Be sure to provide a mechanical interlock for MC2 and MC3.

- Operation of magnetic contactor (MC1, MC2, MC3)

Magnetic contactor	Installation location	Operation status		
		During commercial power supply operation	During inverter operation	During inverter fault
MC1	Between power supply and inverter input side	Shorted	Shorted	Open (shorted after the reset)
MC2	Between power supply and motor	Shorted	Open	Open (Selected by <b>Pr.138</b> . Always open when the external thermal relay is operating.)
MC3	Between inverter output side and motor	Open	Shorted	Open

- The input signals are as shown below.

Signal	Terminal	Function	Operation status	MC operation <sup>*8</sup>		
				MC1 <sup>*6</sup>	MC2	MC3
MRS	MRS <sup>*1</sup>	Electronic bypass switching function (enable/disable) <sup>*2</sup>	ON: Electronic bypass switching function enabled.	○	—	—
			OFF: Electronic bypass switching function disabled.	○	×	Unchanged
CS	CS	Inverter/commercial power supply operation switchover <sup>*3</sup>	ON Inverter operation	○	×	○
			OFF Commercial power supply operation	○	○	×
STF (STR)	STF (STR)	Inverter operation command (disabled during commercial power supply operation) <sup>*4</sup>	ON Forward rotation (reverse rotation)	○	×	○
			OFF Stop	○	×	○
OH	Selected from <b>Pr.180 to Pr.189</b> to set "7".	External thermal relay input	ON Motor normal	○	—	—
			OFF Motor fault	×	×	×
RES	RES	Operation status reset <sup>*5</sup>	ON Reset	Unchanged	×	Unchanged
			OFF Normal operation	○	—	—
X95/X96	Selected from <b>Pr.180 to Pr.189</b> to set "95/96".	Converter unit fault / Converter unit fault (E.OHT, E.CPU)	X95 signal OFF, X96 signal OFF. Converter fault (E.OHT, E.CPU).	×	×	×
			X95 signal ON, X96 signal ON. Converter normal.	○	—	—
			X95 signal OFF, X96 signal ON. Converter fault (other than E.OHT or E.CPU).	×	— <sup>*7</sup>	×

- \*1 For separated converter types, the X10 signal is assigned to the terminal MRS in the initial setting. For the MRS signal, set "24" to any of **Pr.180 to Pr.189 (Input terminal function selection)** to assign the function to another terminal.
- \*2 When the MRS signal is OFF, neither the commercial power supply operation nor the inverter operation can be performed.
- \*3 The CS signal operates only when the MRS signal is ON.
- \*4 STF (STR) operates only when the MRS and CS signals are both ON.
- \*5 Whether or not to enable reset input using the RES signal depends on the setting of **Pr.75 Reset selection/disconnected PU detection/PU stop selection**. When the RES signal and another input signal are simultaneously input, the MC operation by the RES signal has a higher priority.
- \*6 MC1 opens at an inverter fault.

- \*7 MC2 opens when Pr.138 (Automatic bypass switching after inverter fault) = "0" (disabled), and MC2 closes when Pr.138 = "1" (enabled).
- \*8 MC operation is as shown below.

Notation	MC operation
○	ON
×	OFF
—	MC2-OFF, MC3-ON during inverter operation, MC2-ON, MC3-OFF during commercial power supply operation
Unchanged	The status of the MC remains the same after turning ON or OFF of the signal.

- Output signal list

Signal	Terminal (Pr.190 to Pr.196 setting)	Description
MC1	17	Output signal to control MC1 installed on the inverter input side.
MC2	18	Output signal to control MC2 installed for commercial power supply operation.
MC3	19	Output signal to control MC3 installed on the inverter output side.

## ◆ Electronic bypass operation sequence

- Example of operation sequence without automatic bypass sequence (Pr.139 = "9999")

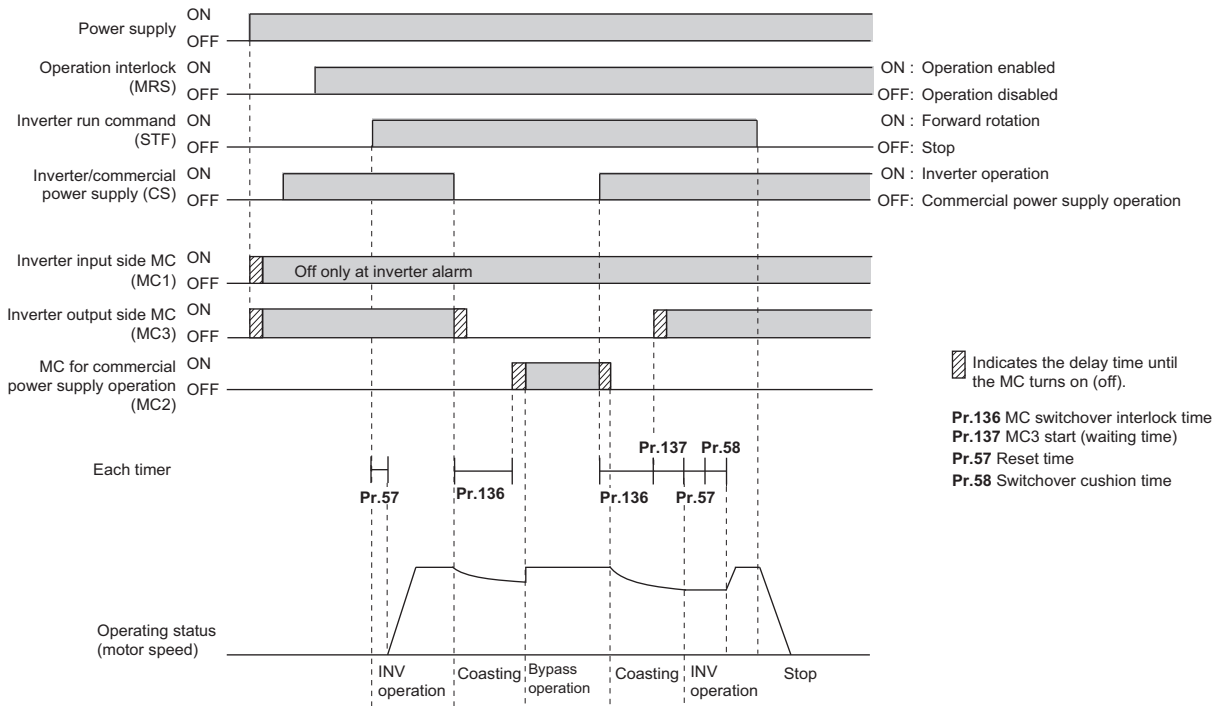

- Example of operation sequence with automatic bypass sequence (Pr.139 ≠ "9999", Pr.159 = "9999")

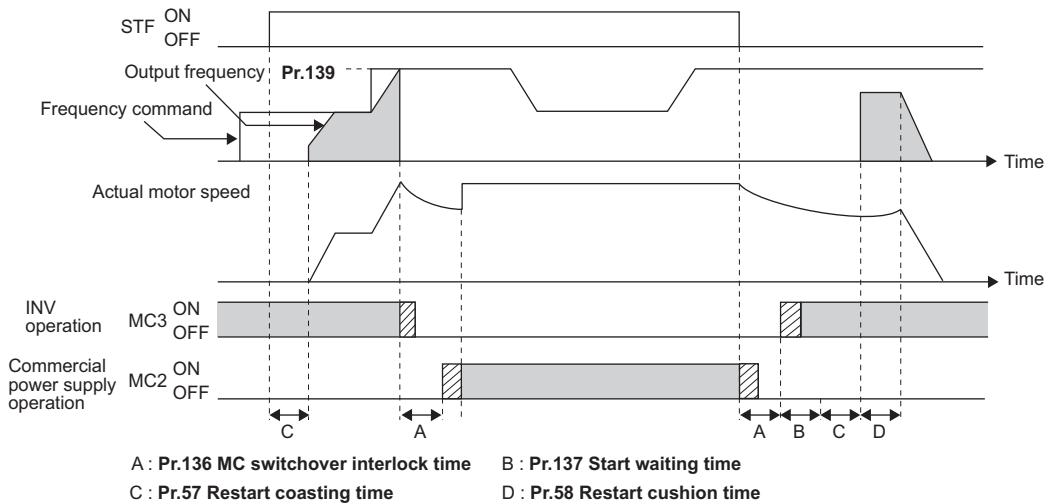

- Example of operation sequence with automatic bypass sequence (**Pr.139** ≠ "9999", **Pr.159** ≠ "9999")

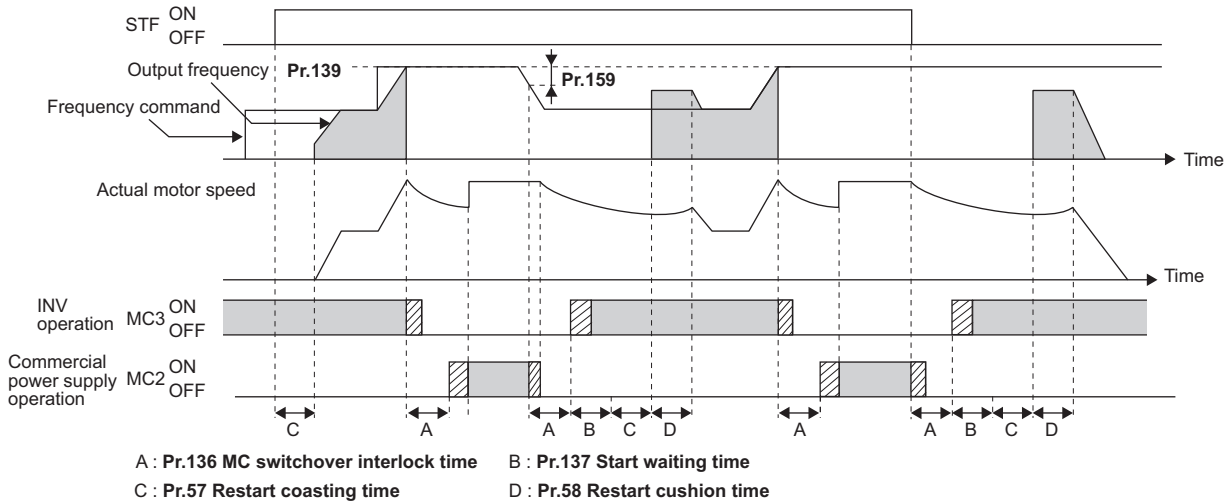

## Operating procedure

- Operation flowchart

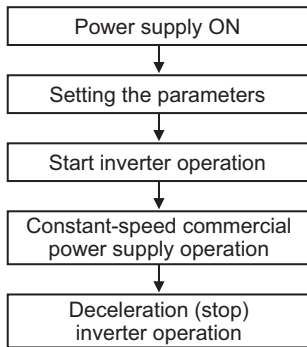

- **Pr.135** = "1"
- **Pr.136** = 2.0 s
- **Pr.137** = 1.0 s (Set the time until MC3 is actually turned ON and the inverter and motor are electrically connected. If the time is short, the restart may not function properly.)
- **Pr.57** = 0.5 s
- **Pr.58** = 0.5 s (Always set this to switchover from the commercial power supply operation to the inverter operation.)

- Signal operation after setting parameters

Status	MRS	CS	STF	MC1	MC2	MC3	Remarks
Power ON	OFF (OFF)	OFF (OFF)	OFF (OFF)	OFF→ON (OFF→ON)	OFF (OFF)	OFF → ON (OFF → ON)	External operation mode (PU operation mode)
At start (inverter)	OFF→ON	OFF→ON	OFF→ON	ON	OFF	ON	
During constant-speed operation (commercial power supply)	ON	ON→OFF	ON	ON	OFF→ON	ON→OFF	MC2 turns ON after MC3 turns OFF. The delay time is 2 s (while coasting).
Switching to inverter operation due to deceleration (inverter)	ON	OFF→ON	ON	ON	ON→OFF	OFF→ON	MC3 turns ON after MC2 turns OFF. The delay time is 4 s (while coasting).
Stop	ON	ON	ON→OFF	ON	OFF	ON	

**NOTE**

- Take power from any point between the power supply and MC1 to the terminals for control circuit power input (R1/L11 and S1/L21). If power is taken from any point between MC1 and the inverter, the electronic bypass sequence function does not work.
- The electronic bypass sequence function is enabled only when **Pr.135** = "1" and the inverter is in the External operation mode or the PU/External combined operation mode 1 (**Pr.79** = "3" (frequency command using the PU and start command using the external signals)). When **Pr.135** = "1" but the inverter is in the operation mode other than mentioned above, the MC1 and MC3 signals are ON.
- MC3 turns ON when the MRS and CS signals are ON and the STF (STR) signal is OFF. If the motor coasted to a stop from commercial power supply operation at the previous stop, the motor starts running after the time set in **Pr.137**.
- Inverter operation is only available when the MRS, STF (STR), and CS signals are ON. In all other cases (when the MRS signal is ON), commercial power supply operation is available.
- When the CS signal is OFF, the motor switches to the commercial power supply operation. However, when the STF (STR) signal is OFF, the motor decelerates to a stop during inverter operation.
- From the point where MC2 and MC3 are both turned OFF, there is a delay time set with **Pr.136**, till MC2 or MC3 is turned ON.
- Even when the electronic bypass sequence is enabled (**Pr.135** = "1"), the **Pr.136** and **Pr.137** settings are disabled in PU operation mode.  
In addition, the input terminals (STF, CS, MRS, OH) return to perform their normal functions.
- When both the electronic bypass sequence function and the PU operation interlock function are enabled at the same time (**Pr.135** = "1" and **Pr.79** = "7") and the PU operation external interlock (X12) signal is not assigned to any input terminal, the MRS signal will have another function as the X12 signal. (In this case, the inverter operation is enabled when both the MRS signal and the CS signal are ON.)
- Set the acceleration time to the level that does not activate the stall prevention operation.
- If switching to the commercial power supply operation while a failure such as an output short circuit has occurred between the magnetic contactor MC3 and the motor, the damage may further spread. If a failure has occurred between the MC3 and the motor, a protection circuit such as using the OH signal input must be provided.
- Changing the terminal functions with **Pr.178 to Pr.189** and **Pr.190 to Pr.196** may affect other functions. Set parameters after confirming the function of each terminal.
- Switching with the electronic bypass sequence is not available during retry. Switching occurs after the retry. When the electronic bypass is valid at a fault (**Pr.138** = "1"), switching occurs also during retry.
- When the electronic bypass sequence function and the retry function of the converter unit are used at the same time for the separated converter type, set 101 or more in the number of retries at fault occurrence (**Pr.67**) on the converter unit side. When a value less than 100 is set, the ALM signal does not turn ON until the retry count is exceeded. In this case, the electronic bypass at a fault is not performed until the retry count is exceeded.
- To use X95 and X96 signals for the separated converter type, use a converter unit manufactured in August 2014 or later.

**◆ Precautions for electronic bypass sequence function**

- The response time of the inverter to the signals depends on the command source, NET or External.

After the communication with the inverter is established, the motor operation is performed according to the command via NET. The commercial power supply operation with the motor is performed when the MRS signal turns ON before the communication is established. It is recommended to turn the MRS signal ON after the communication is established.

Example: the response time of the inverter to the signals in the Network operation mode (power-ON). The command source is External for the MRS signal and NET for the STF (STR) and CS signals.

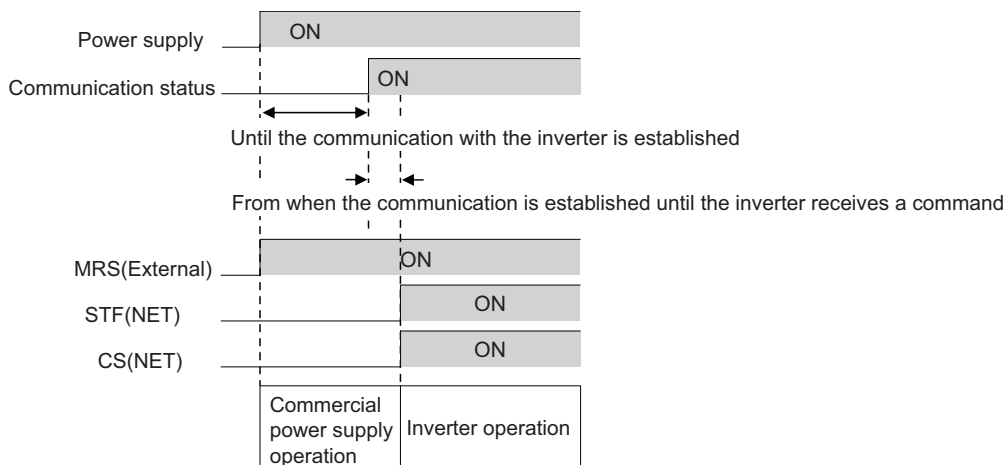

## ◆ Operation in combination with the self power management function for the separated converter type

- When the self power management function is used with the separated converter type, the input signal operations are as follows.

X95 (Converter unit fault)	X96 (Converter unit fault (E.OHT, E.CPU))	X94 (Control signal for main circuit power supply MC)	MC operation <sup>*3</sup>			Converter status
			MC1	MC2	MC3	
OFF	OFF	ON	○ <sup>*2</sup>	×	×	Converter fault (E.OHT (Pr.248 = "2"))
		OFF	×	×	×	Converter fault (E.OHT (Pr.248 = "1"), E.CPU)
ON	ON	ON	○ <sup>*2</sup>	—	—	Converter normal
OFF	ON	ON	○ <sup>*2</sup>	— <sup>*1</sup>	×	Converter fault (other than the circuit failure fault or E.OHT) (Pr.248 = "2")
		OFF	×	— <sup>*1</sup>	×	Converter fault (other than E.OHT or E.CPU)

\*1 When Pr.138 = "0 (electronic bypass invalid at a fault)", MC2 is OFF. When Pr.138 = "1 (electronic bypass valid at a fault)", MC2 is ON.

\*2 The self power management operation is followed.

\*3 MC operation is as shown below.

Notation	MC operation
○	ON
×	OFF
—	MC2-OFF, MC3-ON during inverter operation, MC2-ON, MC3-OFF during commercial power supply operation

### Parameters referred to

Pr.11 DC injection brake operation time [page 715](#)

Pr.57 Restart coasting time [page 628](#), [page 635](#)

Pr.58 Restart cushion time [page 628](#)

Pr.79 Operation mode selection [page 389](#)

Pr.178 to Pr.189 (Input terminal function selection) [page 521](#)

Pr.190 to Pr.196 (Output terminal function selection) [page 473](#)

## 5.14.2 Self power management



By turning ON the magnetic contactor (MC) on the input side before the motor is started and turning OFF the MC after the motor is stopped, power is not supplied to the main circuit, reducing the standby power.

Pr.	Name	Initial value	Setting range	Description
248 A006	Self power management selection	0	0	Self power management function disabled
			1	Self power management function enabled (main circuit OFF at protective function activation)
			2	Self power management function enabled (main circuit OFF at protective function activation due to a circuit failure)
137 A002	Start waiting time	0.5 s	0 to 100 s	Set a time period that is a little longer than the time period from the ON signal input to the actual pick-up operation of MC1 (0.3 to 0.5 s).
254 A007	Main circuit power OFF waiting time	600 s	1 to 3600 s	Set the delay time until the main circuit power supply is turned OFF after the motor is stopped.
			9999	The main circuit power supply is turned OFF only when the protective function selected by Pr.248 is activated.
30 E300	Regenerative function selection	0	100, 101	Power supply to the inverter: AC (terminals R, S, and T). When power is supplied only to the control circuit, and then switched to be supplied to both the control and main circuits, inverter reset is not performed.
			0 to 2, 10, 11, 20, 21, 102, 110, 111, 120, 121	For other settings, refer to <a href="#">page 724</a> .

## ◆ Connection diagram

- Terminal R1, S1 inputs

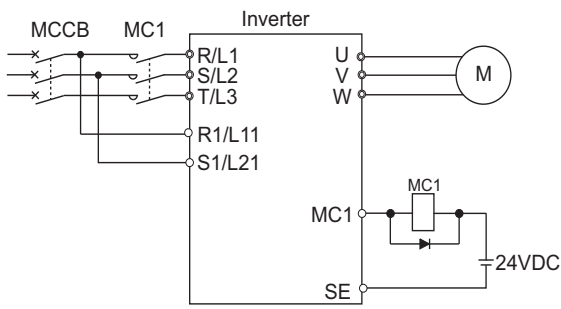

Standard models

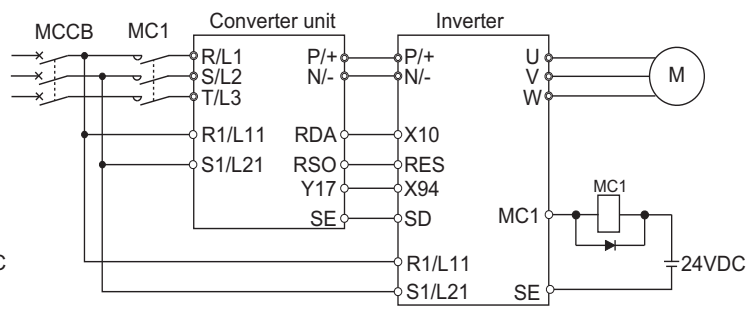

Separated converter type

- 24 V external power supply input

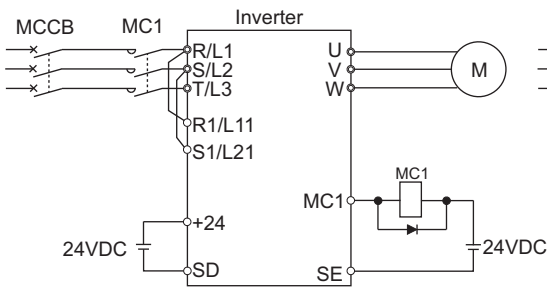

Standard models and IP55 compatible models

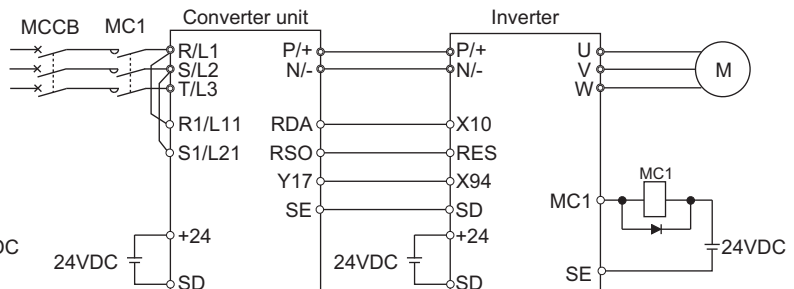

Separated converter type

## ◆ Operation of the self power management function

- This function controls the magnetic contactor (MC) on the input side using the output relay to reduce the standby power during inverter stop. With the terminals R1/L11 and S1/L21 (refer to [page 77](#)) and 24 V external power supply input (refer to [page 80](#)), the main circuit power supply and control circuit power supply are separated, and the MC for main circuit power supply is controlled by the electronic bypass MC1 signal.
- Set **Pr.248 Self power management selection** = "1 or 2", **Pr.30 Regenerative function selection** ≠ "20, 21, 120, or 121" (other than DC feeding mode 2), and **Pr.190 to Pr.196 (Output terminal function selection)** = "17 (positive logic)" to assign the Electronic bypass MC1 (MC1) signal to an output terminal.
- After the inverter is stopped and the time set in **Pr.11 DC injection brake operation time** and **Pr.254 Main circuit power OFF waiting time** have passed, turning OFF the MC1 signal releases the MC on the input side (main circuit power supply OFF). Set **Pr.254** to prevent frequent MC operation.
- Turning ON the start signal turns ON the MC1 signal and closes the MC on the input side (main circuit power supply ON). After the time set in **Pr.137 Start waiting time** has passed, the inverter starts. Set time slightly longer (about 0.3 to 0.5 s) than the time period from the MC1-ON to the actual pick-up operation of the MC is turned ON in **Pr.137**.

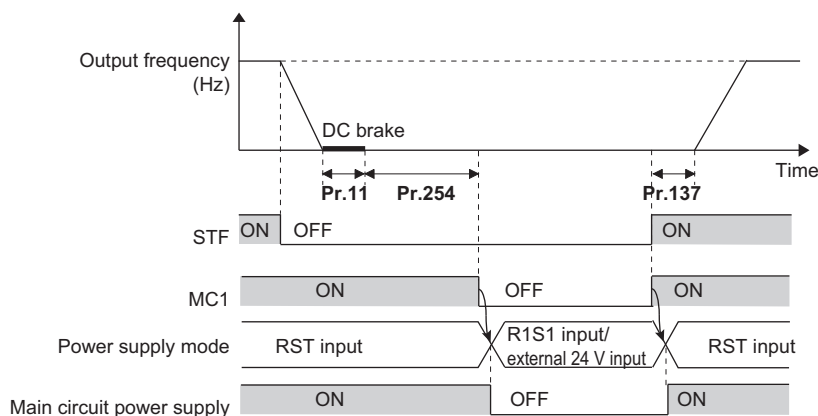

- When the protective function of the inverter is activated, the MC1 signal is immediately turned OFF according to the **Pr.248** setting. (The MC1 signal is turned OFF before the time set in **Pr.254** has passed.)

When **Pr.248** ="1", the MC1 signal is turned OFF when the protective function is activated due to any cause.

When **Pr.248** ="2", the MC1 signal is turned OFF only when the protective function is activated due to an error resulted from a failure in the inverter circuit or a wiring error (refer to the following table). (For the fault details, refer to [page 779](#).)

Fault type
Inrush current limit circuit fault (E.IOH)
CPU fault (E.CPU)
CPU fault (E.6)
CPU fault (E.7)
Parameter storage device fault (control circuit board) (E.PE)
Parameter storage device fault (main circuit board) (E.PE2)
24 VDC power fault (E.P24)
Operation panel power supply short circuit/RS-485 terminals power supply short circuit (E.CTE)
Output side earth (ground) fault overcurrent (E.GF)
Output phase loss (E.LF)
Brake transistor alarm detection (E.BE)
Internal circuit fault (E.13/E.PBT)

- To enable the self power management function for the separated converter type, enable the self power management function also on the converter unit side. To activate the self power management function when a converter unit fault occurs, connect the terminal to which the Y17 signal of the converter unit is assigned and the terminal to which X94 signal of the inverter is assigned.

Y17 output signal (converter unit)	MC1 output signal (inverter)	MC1 output signal actual operation	Main circuit power supply
OFF	OFF	OFF	Stop
OFF	ON	OFF	Stop
ON	OFF	OFF	Stop
ON	ON	ON	Supplied

- To use the X94 signal, set "94" in any of **Pr.178 to Pr.189 (Input terminal function selection)** to assign the function to an input terminal.



## NOTE

- When the start signal is turned OFF before the time set in **Pr.137** has passed after the start signal is turned ON, the inverter does not start and the MC1 signal is turned OFF after the time set in **Pr.254** has passed. If the start signal is turned ON again before the time set in **Pr.254** has passed, the inverter immediately starts outputting.

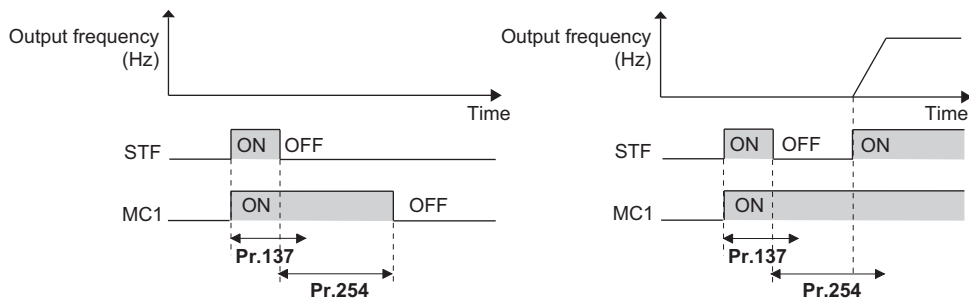

- At inverter reset, the status of the MC1 signal is held and operation of the magnetic contactor is not performed.
- When the inverter stops the output due to, for example, the Output stop (MRS) signal, the MC1 signal is turned OFF after the time set in **Pr.254** has passed.
- During the stop, turning ON the External DC injection brake operation start signal (X13) and Pre-excitation/servo ON signal (LX) turns ON the MC1 signal.
- To avoid inverter reset when supplying power to the main circuit is started when power is supplied only to the control circuit, set 100 or more in **Pr.30**. (For the separated converter type, setting **Pr.30** of the converter unit is also required.)
- When supplying power to the main circuit is started when power is supplied only to the control circuit, there is a slight delay before starting.
- Repeated operation of the magnetic contactor due to frequent start and stop or activation of the protective function may shorten the inverter life.
- Changing the terminal assignment using **Pr.178 to Pr.189 (Input terminal function selection)** and **Pr.190 to Pr.196 (Output terminal function selection)** may affect the other functions. Set parameters after confirming the function of each terminal.
- To use X94 signal for the separated converter type, use a converter unit manufactured in August 2014 or later.

### Parameters referred to

Pr.11 DC injection brake operation time [page 715](#)

Pr.30 Regenerative function selection [page 724](#)

Pr.190 to Pr.196 (Output terminal function selection) [page 473](#)

## 5.14.3 Brake sequence function

This function outputs operation timing signals of the mechanical brake from the inverter, such as for lift applications.

This function is useful in preventing load slippage at a start due to poor mechanical brake timing and overcurrent alarm in stop status and enable secure operation.

Pr.	Name	Initial value	Setting range	Description
278 A100	Brake opening frequency	3 Hz	0 to 30 Hz	Set the rated slip frequency of the motor + approx. 1.0 Hz. This can be set only when <b>Pr.278</b> ≤ <b>Pr.282</b> .
279 A101	Brake opening current	130%	0 to 400%	Set between 50 and 90% because load slippage is more likely to occur when a start setting is too low. The inverter rated current is regarded as 100%, or the rated motor torque is regarded as 100%. (According to <b>Pr.639</b> setting)
280 A102	Brake opening current detection time	0.3 s	0 to 2 s	Generally set between 0.1 and 0.3 s.
281 A103	Brake operation time at start	0.3 s	0 to 5 s	Set the mechanical delay time until braking eases. When <b>Pr.292</b> = "8", set the mechanical delay time until braking eases + approx. 0.1 to 0.2 s.
282 A104	Brake operation frequency	6 Hz	0 to 30 Hz	Turn OFF the Brake opening request (BOF) signal and set the frequency for operating the electromagnetic brake. Generally, set the setting value of <b>Pr.278</b> + 3 to 4 Hz. This can be set only when <b>Pr.282</b> ≥ <b>Pr.278</b> .
283 A105	Brake operation time at stop	0.3 s	0 to 5 s	When <b>Pr.292</b> = "7", set the mechanical delay time until the brake closes + 0.1 s. When <b>Pr.292</b> = "8", set the mechanical delay time until the brake closes + approx. 0.2 to 0.3 s.

Pr.	Name	Initial value	Setting range	Description
284 A106	Deceleration detection function selection	0	0	The deceleration detection function disabled.
			1	The protective function is activated when the deceleration speed of the deceleration operation is not normal.
285 A107	Overspeed detection frequency <sup>*1</sup>	9999	0 to 30 Hz	The Brake sequence fault (E.MB1) is activated when the difference between the detection frequency and output frequency is equal to or greater than the setting value under encoder feedback control.
			9999	Overspeed detection disabled.
292 A110 F500	Automatic acceleration/ deceleration	0	0	Normal operation
			1, 11	Operation with the shortest acceleration/deceleration time. (Refer to page 384.)
			3	Operation with the optimum acceleration/deceleration time. (Refer to page 384.)
			5, 6	Lift operation 1, 2. (Refer to page 387.)
			7	Brake sequence mode 1
			8	Brake sequence mode 2
			639 A108	Brake opening current selection
		1	1	Brake opening by motor torque
640 A109	Brake operation frequency selection	0	0	Brake closing operation by frequency command
			1	Brake closing operation by the actual motor rotation speed (estimated value)
641 A130	Second brake sequence operation selection	0	0	Normal operation when the RT signal is ON
			7	Second brake sequence 1 when the RT signal is ON
			8	Second brake sequence 2 when the RT signal is ON
			9999	First brake sequence is valid when the RT signal is ON
642 A120	Second brake opening frequency	3 Hz	0 to 30 Hz	Refer to Pr.278.
643 A121	Second brake opening current	130%	0 to 400%	Refer to Pr.279.
644 A122	Second brake opening current detection time	0.3 s	0 to 2 s	Refer to Pr.280.
645 A123	Second brake operation time at start	0.3 s	0 to 5 s	Refer to Pr.281.
646 A124	Second brake operation frequency	6 Hz	0 to 30 Hz	Refer to Pr.282.
647 A125	Second brake operation time at stop	0.3 s	0 to 5 s	Refer to Pr.283.
648 A126	Second deceleration speed detection selection	0	0, 1	Refer to Pr.284.
650 A128	Second brake opening current selection	0	0, 1	Refer to Pr.639.
651 A129	Second brake operation frequency selection	0	0, 1	Refer to Pr.640.

Set the second brake sequence function. The second brake sequence function is enabled when the RT signal is ON.

\*1 The speed deviation excess detection frequency is used when Vector control compatible option is mounted during Vector control. (Refer to page 269 for details.)

## ◆ Connection diagram

- Sink logic
- Pr.184 = 15
- Pr.190 = 20

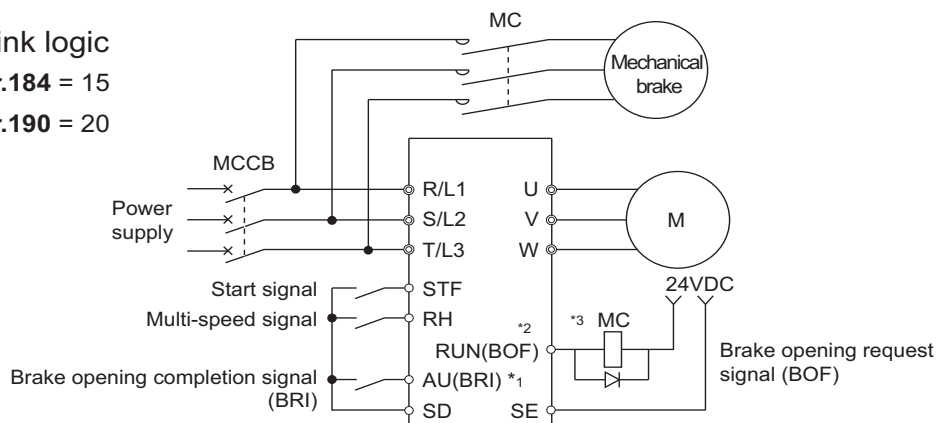

\*1 The input signal terminals differ by the settings of Pr.178 to Pr.189.

\*2 The output signal terminals differ by the settings of Pr.190 to Pr.196.

## NOTE

- The automatic restart after instantaneous power failure function and orientation function do not operate when brake sequence is selected.
- To use this function, set the acceleration/deceleration time to 1 s or higher.
- Changing the terminal assignment using **Pr.178 to Pr.189 (Input terminal function selection)** and **Pr.190 to Pr.196 (Output terminal function selection)** may affect the other functions. Set parameters after confirming the function of each terminal.

## ◆ Setting the brake sequence operation

- Set **Pr.292 Automatic acceleration/deceleration** = "7 or 8 (braking sequence operation)".  
To ensure sequence operation, it is recommended to use with **Pr.292** = "7" (with brake opening completion signal input).
- Set "15" in any of **Pr.178 to Pr.189 (Input terminal function selection)**, and assign the Brake opening completion (BRI) signal to the input terminal.
- Set "20" (positive logic) or "120" (negative logic) in any of **Pr.190 to Pr.196 (Output terminal function selection)**, and assign the brake opening request signal (BOF) to the output terminal.
- Use **Pr.639 Brake opening current selection** to select whether the output current or the motor torque is used as a reference for the brake opening operation. (Under V/F control, this operation is activated regardless of the **Pr.639** setting.)
- Under Real sensorless vector control, Vector control, or PM sensorless vector control, use **Pr.640 Brake operation frequency selection** to select whether the frequency command or the actual motor speed (estimated value) is used as a reference for brake closing operation. If the brake operation timing is different from the motor speed because of the load, set **Pr.640** = "1 (brake operation with the actual motor speed (estimated value))".
- Under V/F control or Advanced magnetic flux vector control, the frequency command is used as a reference for brake operation regardless of the **Pr.640** setting.

## NOTE

- Under torque control, position control, or PM sensorless vector control (with the low-speed range high torque characteristic disabled), the brake sequence function is disabled.

## ◆ Operation with brake opening completion signal input (Pr.292 = "7")

- When the start signal is input to the inverter, the inverter starts running, and when the output frequency reaches the frequency set in **Pr.278 Brake opening frequency** and the output current or the motor torque is equal to or greater than the **Pr.279 Brake opening current** setting, the brake opening request signal (BOF) is output after the time set in **Pr.280 Brake opening current detection time**. The Brake opening completion (BRI) signal is input, and the output frequency is increased to the set speed after the set time in **Pr.281 Brake operation time at start**.

- When the inverter decelerates to the frequency set to **Pr.282 Brake operation frequency** during deceleration, the inverter turns OFF the brake opening request signal (BOF) and decelerates further to the frequency set in **Pr.278**. After electromagnetic brake operation completes and the inverter recognizes the turn OFF of the BRI signal, the inverter holds the frequency set in Pr.278 for the time set in **Pr.283 Brake operation time at stop**. And after the time set in Pr.283 passes, the inverter decelerates again. The inverter outputs is shut off when the frequency reaches **Pr.13 Starting frequency** setting or 0.5 Hz, whichever is lower.

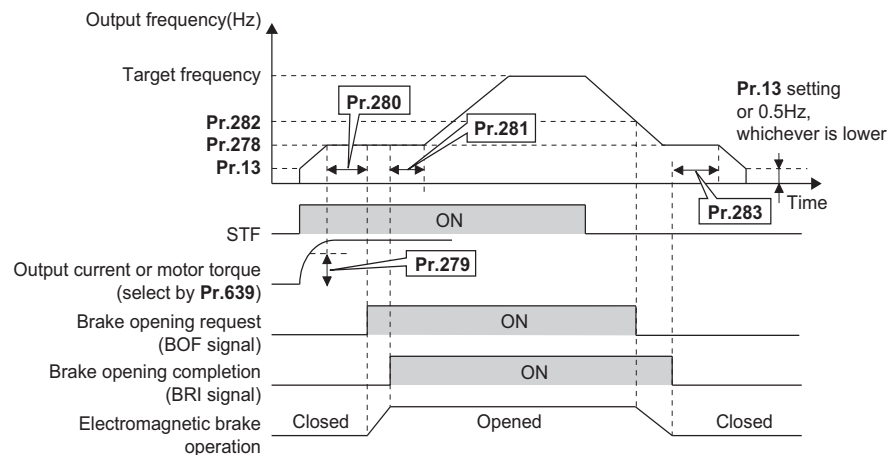

### ◆ Operation without Brake opening completion (Pr.292 = "8") signal input

- When the start signal is input to the inverter, the inverter starts running, and when the output frequency reaches the frequency set in **Pr.278 Brake opening frequency** and the output current or the motor torque is equal to or greater than the **Pr.279 Brake opening current** setting, the brake opening request signal (BOF) is output after the time set in **Pr.280 Brake opening current detection time**. After the BOF signal is output, the output frequency is increased to the set speed after the set time in **Pr.281 Brake operation time at start**.
- When the inverter decelerates to the frequency set to **Pr.282 Brake operation frequency** during deceleration, the inverter turns OFF the brake opening request signal (BOF) and decelerates further to the frequency set in **Pr.278**. And after the time set in **Brake operation time at stop** passes, the inverter decelerates again. **Pr.13 Starting frequency** setting or 0.5 Hz, whichever is lower

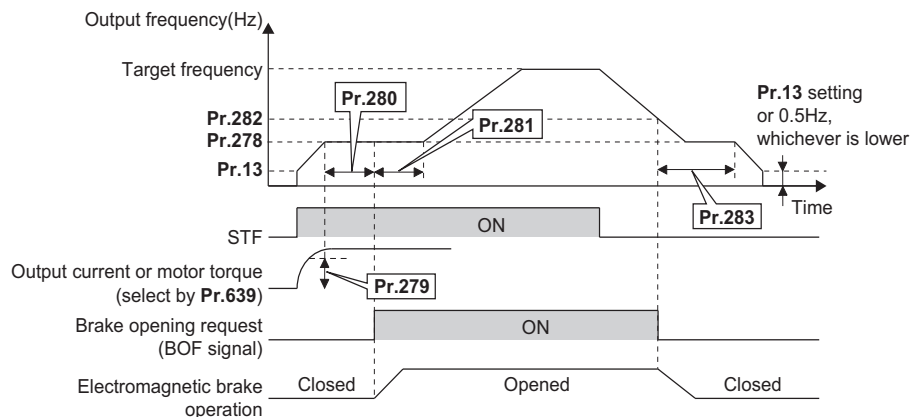

#### NOTE

- Even if the brake sequence operation has been selected, inputting the JOG signal (JOG operation) changes the operation method to normal operation and give a priority to the JOG operation. Note that the JOG signal input by the brake sequence function is invalid during operation.

### ◆ Set multiple brake sequence functions (Pr.641)

- When the second brake sequence function is set, it is possible to switch between and use two types of brake sequence functions. Turning ON the Second function selection (RT) signal enables the Second brake sequence function.

- Select the operation of the Second brake sequence function with **Pr.641 Second brake sequence operation selection**.

Pr.641 setting	Brake sequence function when the RT signal is ON
0 (initial value)	Normal operation (The first and second brake sequence functions invalid)
7	Second brake sequence mode 1
8	Second brake sequence mode 2
9999	First brake sequence mode is valid

- Set "45" in any of **Pr.178 to Pr.189 (Input terminal function selection)** to assign the Second brake sequence open completion signal (BRI2) to the input terminal.
- To use the Second brake opening request signal (BOF2), set "22 (positive logic)" or "122 (negative logic)" in any of **Pr.190 to Pr.196 (Output terminal function selection)** to assign the function to the output terminal.
- The method of setting the second brake sequence parameters is the same as that for the corresponding first brake sequence function parameters.
- Switchover of the brake sequence function by RT signal is valid when the inverter is stopped.

## ◆ Protective function

- If one of the following faults occur while the brake sequence function is enabled, the inverter enters an fault status, shuts off output, and turns OFF the brake opening request signal (BOF).

Fault indication	Description
E.MB1	When (detection frequency) - (output frequency) $\geq$ <b>Pr.285</b> during encoder feedback control. When <b>Pr.285</b> (Overspeed detection function) = 9999, overspeed is not detected.
E.MB2	When deceleration is not normal during deceleration operation from the set frequency to the frequency set in <b>Pr.282</b> . (when <b>Pr.284</b> = 1) (except stall prevention operation)
E.MB3	When the BOF signal turned ON while the motor is at a stop. (load slippage prevention function)
E.MB4	When more than 2 s have elapsed after the start command (forward or reverse rotation) is input, but the BOF signal does not turn ON.
E.MB5	When more than 2 s have elapsed after the BOF signal turned ON, but the BRI signal does not turn ON.
E.MB6	When the inverter had turned ON the brake opening request signal (BOF), but the BRI signal turned OFF.
E.MB7	When more than 2 s have elapsed after the BOF signal turned OFF at a stop, but the BRI signal does not turn OFF.

### NOTE

- During PM sensorless vector control, the brake sequence function is available with the IPM motor MM-CF only.
- During deceleration, inverter output is shut OFF when the frequency reaches **Pr.13 Starting frequency** or 0.5 Hz, whichever is lower. For **Pr.278 Brake opening frequency**, set a frequency equal to or higher than the **Pr.13** setting or 0.5 Hz.
- **Pr.285 Overspeed detection frequency** is valid under encoder feedback control (used with the FR-A8AP (option)) even if a value other than "7 or 8" is set in **Pr.292 Automatic acceleration/deceleration**.
- Setting **Pr.278** too high activates the stall prevention and may cause E.MB4.
- E.MB4 occurs when the acceleration time from **Pr.13** to **Pr.278 + Pr.280** reaches or exceeds 2 s.

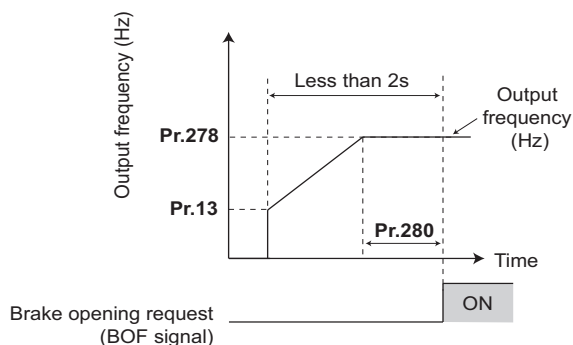

### Parameters referred to

Pr.3 Base frequency [page 707](#)

Pr.178 to Pr.189 (Input terminal function selection) [page 521](#)

Pr.190 to Pr.196 (Output terminal function selection) [page 473](#)

## 5.14.4 Start count monitor

The inverter starting times can be counted.

Confirming the starting times can be used to determine the timing of the maintenance, or can be used as a reference for system inspection or parts replacement.

Pr.	Name	Initial value	Setting range	Description
1410 A170	Starting times lower 4 digits	0	0 to 9999	Displays the lower four digits of the number of the inverter starting times.
1411 A171	Starting times upper 4 digits	0	0 to 9999	Displays the upper four digits of the number of the inverter starting times.

- Every start signal input (the RUN signal ON) while the inverter output is stopped is counted as the inverter starting time. (Starting during pre-excitation is also counted.)

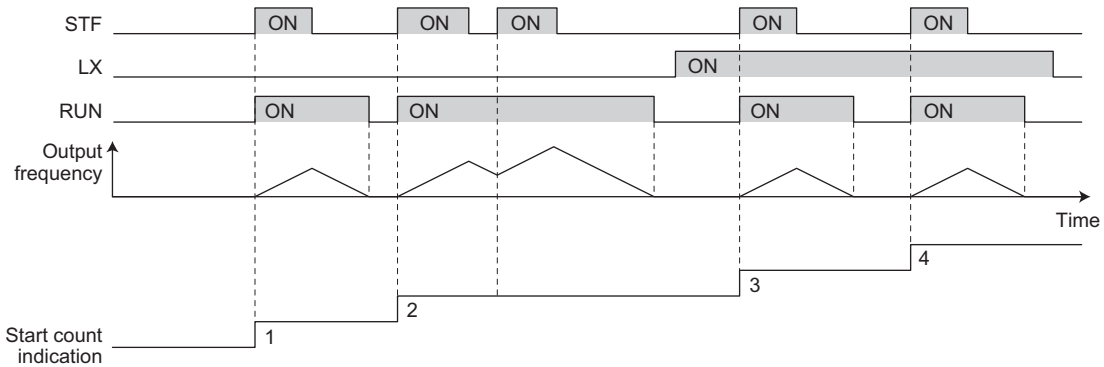

- The lower four digits of the number of starting times is displayed in **Pr.1410 Starting times lower 4 digits**, and the upper four digits of the number of starting times is displayed in **Pr.1411 Starting times upper 4 digits**.
- The maximum count is "99999999". When "99999999" is exceeded on the monitor, the monitor value is reset to 0.

	Display data	Monitor display
10000	Pr.1410 (Lower digits monitor)	0
	Pr.1411 (Upper digits monitor)	1
100	Pr.1410 (Lower digits monitor)	100
	Pr.1411 (Upper digits monitor)	0

### NOTE

- Any value can be set in **Pr.1410** or **Pr.1411**. Set "0" to clear the number on the monitor.
- Starting during offline auto tuning is not counted.
- Under position control, the count increases when the LX signal turns ON.
- The counting is enabled even if the RUN signal is not assigned to an output terminal.
- For the RUN signal, refer to [page 473](#).
- Starting during the test operation (**Pr.800** = "9") is not counted.

## 5.14.5 Stop-on-contact control

**Magnetic flux** **Sensorless**

To ensure accurate positioning at the upper limit, etc. of a lift, stop-on-contact control causes the mechanical brake to close while the motor creates a holding torque to keep the load in contact with a mechanical stopper, etc.

This function suppresses vibration that is likely to occur when the load is stopped upon contact in lift applications, thereby ensuring reliable and highly accurate positioning stop.

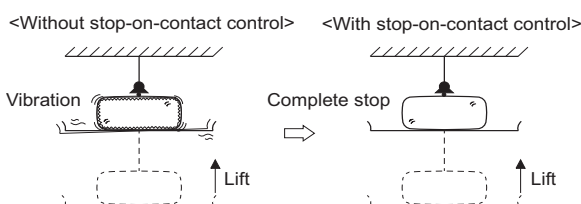

Pr.	Name	Initial value	Setting range	Description	
6 D303	Multi-speed setting (low speed)	10 Hz	0 to 590 Hz	Set the output frequency for stop-on-contact control.	
22 H500	Stall prevention operation level	150%	0 to 400%	Set the stall prevention operation level for stop-on-contact control. The smaller value set in either Pr.22 or Pr.48 has priority.	
48 H600	Second stall prevention operation level	150%	0 to 400%		
270 A200	Stop-on contact/load torque high-speed frequency control selection	0	0	Normal operation	
			1	Stop-on-contact control	
			2	Load torque high-speed frequency control (Refer to page 580.)	
			3	Stop-on contact + load torque high speed frequency control (Refer to page 580.)	
			11	Stop-on-contact control	
			13	Stop-on contact + load torque high speed frequency control (Refer to page 580.)	E.OLT is invalid under stop-on-contact control
275 A205	Stop-on contact excitation current low-speed scaling factor	9999	0 to 300%	Set the force (holding torque) for stop-on-contact control. Normally, set the scaling factor between 130 to 180%.	
			9999	Not compensated.	
276 A206	PWM carrier frequency at stop-on contact	9999	0 to 9 <sup>*1</sup>	Set a PWM carrier frequency for stop-on-contact control. For Real sensorless vector control, the carrier frequency is always 2 kHz when the setting value is 0 to 5 and always 6 kHz when the setting value is 6 to 9. (Valid at the output frequency of 3 Hz or less.)	
			0 to 4 <sup>*2</sup>		
			9999	As set in Pr.72 PWM frequency selection.	

\*1 The setting range of the FR-A820-03160(55K) or lower and the FR-A840-01800(55K) or lower

\*2 The setting range of the FR-A820-03800(75K) or higher and the FR-A840-02160(75K) or higher

## ◆ Connection and operation example

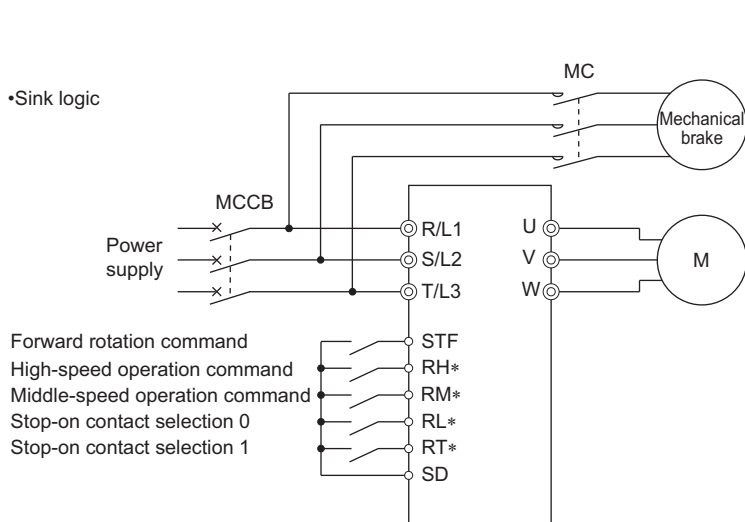

\* The input terminal used differs according to the Pr.180 to Pr.189 settings.

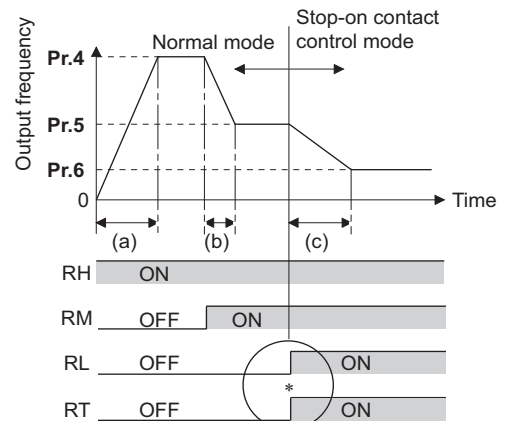

\* Goes into stop-on-contact control mode when both RL and RT switch on. RL and RT may be switched on in any order with any time difference

(a): Acceleration time(Pr.7)

(b): Deceleration time(Pr.8)

(c): Second deceleration time(Pr.44/Pr.45)

## ◆ Setting the stop-on-contact control

- Make sure that the inverter is in External or Network operation mode. (Refer to page 389.)
- Select either Real sensorless vector control (speed control) or Advanced magnetic flux vector control.
- Set "1, 3, 11 or 13" in Pr.270 Stop-on contact/load torque high-speed frequency control selection.
- Set the output frequency for stop-on-contact control in Pr.6 Multi-speed setting (low speed).  
Set the frequency as low as possible (about 2 Hz). If a frequency higher than 30 Hz is set, it operates with 30 Hz.
- When both the RT and RL signals are switched ON, the inverter enters the stop-on-contact control, and operation is performed at the frequency set in Pr.6 independently of the preceding speed.



- Setting **Pr.270** = "11 or 13" disables stall prevention stop (E.OLT) during stop-on-contact control (with both RL and RT signals ON).

**NOTE**

- By increasing the **Pr.275** setting, the low-speed (stop-on-contact) torque increases, but overcurrent fault (E.OC[]) may occur or the machine may oscillate in stop-on-contact status.
- The stop-on-contact function is different from the servo-lock function, and if used to stop or hold a load for an extended period, this function can cause the motor to overheat. After a stop, immediately switch to a mechanical brake to hold the load.
- Under the following operating conditions, the stop-on-contact function is invalid:  
 PU operation (**Pr.79**), JOG operation (JOG signal), PU + External operation (**Pr.79**), PID control function operation (**Pr.128**), Remote setting function operation (**Pr.59**), Automatic acceleration/deceleration operation (**Pr.292**), Start time tuning, Orientation control function operation
- When performing stop-on-contact control during encoder feedback control, encoder feedback control is invalid due to a transition to the stop-on-contact control mode.

**◆ Function switching of stop-on-contact control selection**

Main functions	Normal operation (Either RL or RT is OFF or both are OFF.)		Stop-on-contact control (Both RL and RT are ON.)	
	Real sensorless vector control	Advanced magnetic flux vector control	Real sensorless vector control	Advanced magnetic flux vector control
Output frequency	Multi-speed, 0 to 5 V, 0 to 10 V, 4 to 20 mA, etc.		<b>Pr.6</b> setting	
Stall prevention operation level	—	<b>Pr.22</b> setting	—	The smaller value set in either <b>Pr.22</b> or <b>Pr.48</b> <sup>*1</sup>
Torque limit level	<b>Pr.22</b> setting	—	<b>Pr.22</b> setting	—
Excitation current low-speed scaling factor	—		The current is compensated by <b>Pr.275</b> (0 to 300%) setting from normal operation.	
Carrier frequency	<b>Pr.72</b> setting		When output frequency is 3 Hz or lower, <b>Pr.276</b> setting ( <b>Pr.72</b> when <b>Pr.276</b> = "9999")	
Fast-response current limit	—	Enabled	—	Disabled

\*1 When RL and RT are ON, **Pr.49** Second stall prevention operation frequency is invalid.

**◆ Set frequency and validity of the stop-on-contact control (Pr.270 = "1, 3, 11, 13")**

- The following table lists the frequencies set when the input terminals (RH, RM, RL, RT, JOG) are selected together.
- Stop-on-contact control is disabled when remote setting function is selected (**Pr.59** = 1 to 3).

Input signal					Set frequency	Stop-on-contact control
RH	RM	RL	RT	JOG		
ON					<b>Pr.4</b>	
	ON				<b>Pr.5</b>	
		ON			<b>Pr.6</b>	
			ON		<sup>*1</sup>	
				ON	<b>Pr.15</b>	
ON	ON				<b>Pr.26</b>	
ON		ON			<b>Pr.25</b>	
ON			ON		<b>Pr.4</b>	
ON				ON	<b>Pr.15</b>	
	ON	ON			<b>Pr.24</b>	
	ON		ON		<b>Pr.5</b>	
	ON			ON	<b>Pr.15</b>	
		ON	ON		<b>Pr.6</b>	Enabled
		ON		ON	<b>Pr.15</b>	
			ON	ON	<b>Pr.15</b>	
		ON	ON	ON	<b>Pr.15</b>	

Input signal					Set frequency	Stop-on-contact control
RH	RM	RL	RT	JOG		
	ON		ON	ON	<b>Pr.15</b>	
	ON	ON		ON	<b>Pr.15</b>	
	ON	ON	ON		<b>Pr.6</b>	Enabled
ON			ON	ON	<b>Pr.15</b>	
ON		ON		ON	<b>Pr.15</b>	
ON		ON	ON		<b>Pr.6</b>	Enabled
ON	ON			ON	<b>Pr.15</b>	
ON	ON		ON		<b>Pr.26</b>	
ON	ON	ON			<b>Pr.27</b>	
	ON	ON	ON	ON	<b>Pr.15</b>	
ON		ON	ON	ON	<b>Pr.15</b>	
ON	ON		ON	ON	<b>Pr.15</b>	
ON	ON	ON		ON	<b>Pr.15</b>	
ON	ON	ON	ON		<b>Pr.6</b>	Enabled
ON	ON	ON	ON	ON	<b>Pr.15</b>	
					<sup>*1</sup>	

\*1 By 0 to 5 V (0 to 10 V), 4 to 20 mA input



## NOTE

- Changing the terminal assignment using **Pr.178 to Pr.189 (Input terminal function selection)** may affect the other functions. Set parameters after confirming the function of each terminal.

### Parameters referred to

- Pr.4 to Pr.6, Pr.24 to Pr.27 (multi-speed setting) [page 411](#)
- Pr.15 Jog frequency [page 410](#)
- Pr.22 Stall prevention operation level, Pr.48 Second stall prevention operation level level [page 431](#)
- Pr.22 Torque limit level [page 245](#)
- Pr.59 Remote function selection [page 377](#)
- Pr.72 PWM frequency selection [page 356](#)
- Pr.79 Operation mode selection [page 389](#)
- Pr.95 Online auto tuning selection [page 558](#)
- Pr.128 PID action selection [page 601](#)
- Pr.178 to Pr.189 (Input terminal function selection) [page 521](#)
- Pr.270 Stop-on contact/load torque high-speed frequency control selection [page 580](#)
- Pr.292 Automatic acceleration/deceleration [page 384](#), [page 387](#)

## 5.14.6 Load torque high-speed frequency control

Load torque high-speed frequency control is a function that automatically sets the maximum operable frequency according to the load.

The load size during power driving is estimated by detecting average currents at set timings after a start. When the load is light, the frequency is increased from the originally-set frequency. (In regenerative driving, the frequency is not increased.)

This function is designed to increase speed automatically under light load, for example to minimize the incoming/outgoing time in a multi-story parking lot.

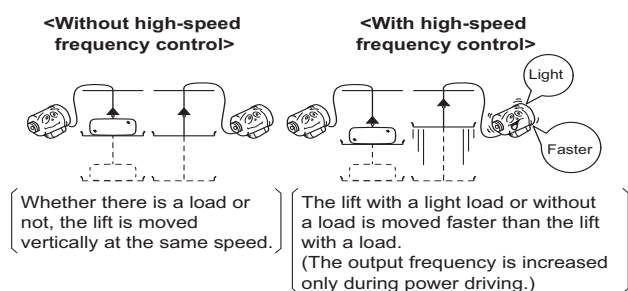

Pr.	Name	Initial value		Setting range	Description	
		FM	CA			
4 D301	Multi-speed setting (high speed)	60 Hz	50 Hz	0 to 590 Hz	Set the higher-speed frequency.	
5 D302	Multi-speed setting (middle speed)	30 Hz		0 to 590 Hz	Set the lower-speed frequency.	
270 A200	Stop-on contact/load torque high-speed frequency control selection	0	0	0	Normal	
			1	0	Stop-on-contact control (Refer to <a href="#">page 577.</a> )	
			2	0	Load torque high-speed frequency control	
			3	0	Stop-on contact + load torque high speed frequency control (Refer to <a href="#">page 577.</a> )	
			11	0	Stop-on-contact control	
			13	0	Stop-on contact + load torque high speed frequency control (Refer to <a href="#">page 577.</a> )	E.OLT is invalid under stop-on-contact control.
271 A201	High-speed setting maximum current	50%		0 to 400%	Set the upper and lower limits of the current at high and middle speeds.	
272 A202	Middle-speed setting minimum current	100%		0 to 400%		
273 A203	Current averaging range	9999	0 to 590 Hz	0 to 590 Hz	Set the average current during acceleration from ( <b>Pr.273</b> × 1/2) Hz to ( <b>Pr.273</b> ) Hz.	
			9999	0 to 590 Hz	Set the average current during acceleration from ( <b>Pr.5</b> × 1/2) Hz to ( <b>Pr.5</b> ) Hz.	
274 A204	Current averaging filter time constant	16		1 to 4000	Set the time constant of the primary delay filter relative to the output current. (The time constant [ms] is 0.5 × <b>Pr.274</b> , and the initial value is 8 ms.) A larger setting results in a stable operation with poorer response.	

## ◆ Connection diagram

- Sink logic
- Pr.186 = 19

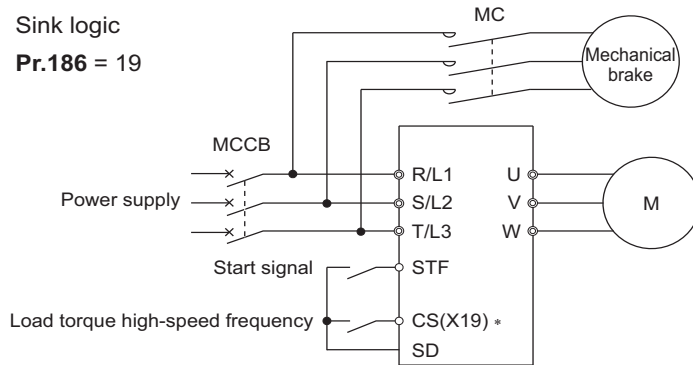

\*1 The applied terminals differ by the settings of Pr.180 to Pr.189 (Input terminal function selection)

## ◆ Load torque high speed frequency control setting

- Set "2, 3 or 13" in Pr.270 Stop-on contact/load torque high-speed frequency control selection.
- When the Load torque high-speed frequency (X19) signal ON, the inverter automatically adjusts the maximum frequency in the range between the Pr.4 Multi-speed setting (high speed) and Pr.5 in accordance with the average current in the current averaging range. The current averaging range is from the 1/2 the Pr.5 Multi-speed setting (middle speed) to the full Pr.5 setting (in the current averaging range).
- To use the X19 signal, set "19" in any of Pr.178 to Pr.189 (Input terminal function selection) to assign the function to an input terminal.
- This is valid in External operation mode and Network operation mode.
- The control can be activated at every start.

## ◆ Operation of load torque high speed frequency control

- When the average current of the current averaging range (chart A below) during operation with the X19 signal ON is the "inverter rated current × Pr.271 setting (%)" or less, the maximum frequency automatically becomes the Pr.4 Multi-speed setting (high speed) setting value.
- When the average current of the current averaging range (chart B below) during operation with the X19 signal ON is greater than the "inverter rated current × Pr.272 setting (%)", the maximum frequency automatically becomes the Pr.5 Multi-speed setting (middle speed) setting value.
- During regeneration load operation, the Pr.5 setting is the maximum frequency regardless of the average current.
- When Pr.273 is used, the current averaging range can be set between one half of the frequency of the Pr.273 setting value and the Pr.273 set frequency. (However, the setting value must be smaller than Pr.5 setting.)

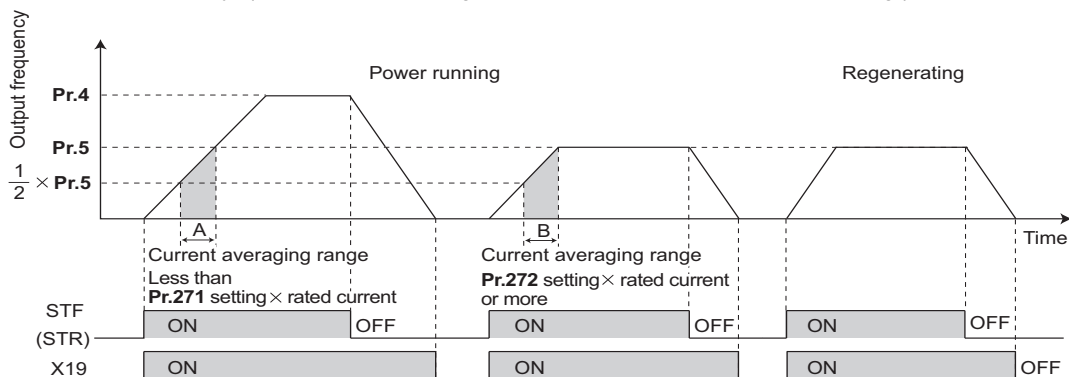

- When the average current is larger than "inverter rated current × Pr.271 setting (%)" and smaller than "inverter rated current × Pr.272 setting (%)", linear compensation is performed as shown below.

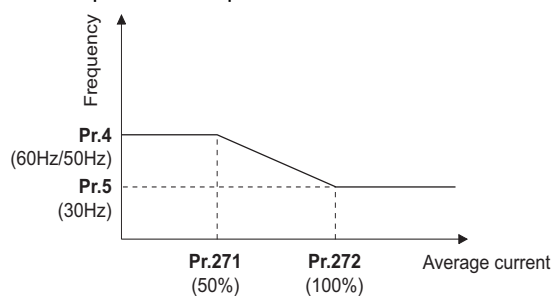

Value in parenthesis is initial value.

## NOTE

- When the current averaging range includes the constant-output range, the output current may become large in the constant-output range.
- When the average current value in the current averaging range is small, deceleration time becomes longer as the output frequency increases.
- The automatic restart after instantaneous power failure function, fast-response current limit operation, fast-response current limit operation, shortest acceleration/deceleration, and optimum acceleration/deceleration are invalid.
- Changing the terminal assignment with **Pr.178 to Pr.189 (Input terminal function selection)** may affect other functions. Set parameters after confirming the function of each terminal.
- Under the following operating conditions, the load torque high-speed frequency function is invalid:  
PU operation (**Pr.79**), PU + External operation (**Pr.79**), JOG operation, PID control function operation (**Pr.128**), remote setting function operation (**Pr.59**), orientation control function operation, multi-speed setting (RH, RM, and RL signals), torque control, position control.
- When the average current during acceleration is too small, it may be judged as regeneration, and the maximum frequency may become the setting of **Pr.5**.
- The output frequency may change due to the load, so do not get unnecessarily close to the motor or machine.

## Parameters referred to

Pr.4 to Pr.6, Pr.24 to Pr.27 (multi-speed setting) [page 411](#)  
 Pr.57 Restart coasting time [page 628](#), [page 635](#)  
 Pr.59 Remote function selection [page 377](#)  
 Pr.79 Operation mode selection [page 389](#)  
 Pr.128 PID action selection [page 601](#)  
 Pr.178 to Pr.189 (Input terminal function selection) [page 521](#)

## 5.14.7 Traverse function

The traverse operation, which oscillates the frequency at a constant cycle, is available.

Pr.	Name	Initial value	Setting range	Description
592 A300	Traverse function selection	0	0	Traverse function invalid
			1	Traverse function valid only in External operation mode
			2	Traverse function valid regardless of the operation mode
593 A301	Maximum amplitude amount	10%	0 to 25%	Level of amplitude during traverse operation
594 A302	Amplitude compensation amount during deceleration	10%	0 to 50%	Compensation amount during amplitude inversion (from acceleration to deceleration)
595 A303	Amplitude compensation amount during acceleration	10%	0 to 50%	Compensation amount during amplitude inversion (from deceleration to acceleration)
596 A304	Amplitude acceleration time	5 s	0.1 to 3600 s	Time period of acceleration during traverse operation
597 A305	Amplitude deceleration time	5 s	0.1 to 3600 s	Time period of deceleration during traverse operation

- Setting Pr.592 Traverse function selection = "1 or 2" enables the traverse function.

- Assigning the Traverse function selection (X37) signal to the input terminal enables the traverse function only when the X37 signal is ON. (When the X37 signal is not assigned, the traverse function is always available.) To input the X37 signal, set "37" in any of **Pr.178 to Pr.189 (Input terminal function selection)** to assign the function to a terminal.

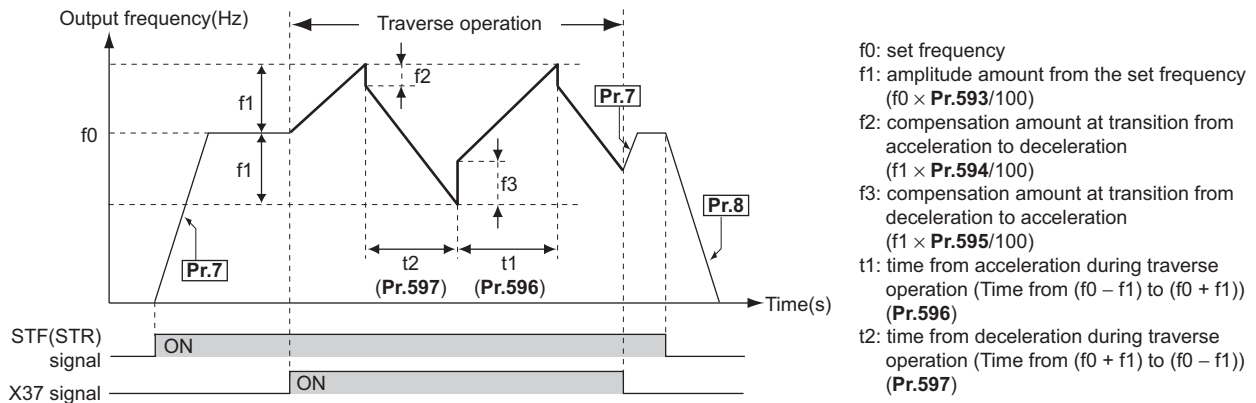

- The motor accelerates to the set frequency  $f_0$  according to the normal **Pr.7 Acceleration time** at turn ON of the start command (STF or STR).
- When the output frequency reaches  $f_0$  and the X37 signal turns ON, the inverter begins traverse operation and accelerates to  $f_0 + f_1$ . The acceleration time at this time is according to the **Pr.596** setting. (If the X37 signal turns ON before the output frequency reaches  $f_0$ , traverse operation begins after the output frequency reaches  $f_0$ .)
- After the inverter accelerates the motor to  $f_0 + f_1$ , this is compensated with  $f_2$  ( $f_1 \times \text{Pr.594}$ ), and the motor decelerates to  $f_0 - f_1$ . The deceleration time at this time is according to the **Pr.597** setting.
- After the inverter decelerates the motor to  $f_0 - f_1$ , this is compensated with  $f_3$  ( $f_1 \times \text{Pr.595}$ ), and the motor accelerates again to  $f_0 + f_1$ .
- When the X37 signal turns OFF during traverse operation, the inverter accelerates/decelerates the motor to  $f_0$  according to the normal acceleration/deceleration time (**Pr.7, Pr.8**). If the start command (STF or STR) is turned OFF during traverse operation, the inverter decelerates the motor to a stop according to the normal deceleration time (**Pr.8**).

#### NOTE

- If the set frequency ( $f_0$ ) and traverse operation parameters (**Pr.593 to Pr.597**) are changed during traverse operation, this is applied in operations after the output frequency reaches  $f_0$  before the change was made.
- If the output frequency exceeds **Pr.1 Maximum frequency** or **Pr.2 Minimum frequency** during traverse operation, the output frequency is clamped at the maximum/minimum frequency when the set pattern exceeds the maximum/minimum frequency.
- When the traverse function and S-pattern acceleration/deceleration (**Pr.29**  $\neq$  "0") are selected, S-pattern acceleration/deceleration occurs only in the range operated at the normal acceleration/deceleration time (**Pr.7, Pr.8**). Acceleration/deceleration during traverse operation is performed linearly.
- If stall prevention activates during traverse operation, traverse operation stops and normal operation begins. When stall prevention operation is completed, the inverter accelerates/decelerates to  $f_0$  at the normal acceleration/deceleration time (**Pr.7, Pr.8**). After the output frequency reaches  $f_0$ , the traverse operation begins again.
- If the value of the amplitude inversion compensation amount (**Pr.594, Pr.595**) is too large, an overvoltage trip or stall prevention occurs, and pattern operation cannot be performed as set.
- Changing the terminal assignment using **Pr.178 to Pr.189 (Input terminal function selection)** may affect the other functions. Set parameters after confirming the function of each terminal.

#### Parameters referred to

Pr.3 Base frequency [page 707](#)

Pr.178 to Pr.189 (Input terminal function selection) [page 521](#)

Pr.190 to Pr.196 (Output terminal function selection) [page 473](#)

## 5.14.8 Anti-sway control

When an object is moved by a gantry crane, swinging is suppressed on the crane's traveling axis.

Pr.	Name	Initial value	Setting range	Description
1072 A310	DC brake judgment time for anti-sway control operation	3 s	0 to 10 s	Set the time from when the output frequency becomes the <b>Pr.10 DC injection brake operation frequency</b> or less to when the DC injection brake (zero speed control or the servo lock) operation starts.
1073 A311	Anti-sway control operation selection	0	0 1	Anti-sway control disabled Anti-sway control enabled
1074 A312	Anti-sway control frequency	1 Hz	0.05 to 3 Hz 9999	Set a swinging frequency of the object. Anti-sway control is performed using a swinging frequency estimated by the inverter according to the settings of <b>Pr.1077 to Pr.1079</b> .
1075 A313	Anti-sway control depth	0	0 to 3	0 (Deep) → 3 (Shallow)
1076 A314	Anti-sway control width	0	0 to 3	0 (Narrow) → 3 (Wide)
1077 A315	Rope length	1 m	0.1 to 50 m	Set the rope length of the crane.
1078 A316	Trolley weight	1 kg	1 to 50000 kg	Set the weight of the trolley.
1079 A317	Load weight	1 kg	1 to 50000 kg	Set the weight of the object.

### ◆ Anti-sway control operation (Pr.1073)

- Setting **Pr.1073 Anti-sway control operation selection** = "1" enables anti-sway control. (Anti-sway control is not available under zero speed or servo lock control.)
- During operation under anti-sway control, the travel distance becomes longer. Input a stop command earlier to avoid a collision with an obstacle.
- A deceleration to stop without anti-sway control is applied for stopping as a result of PU stop, an emergency stop command input from a communication option, **Pr.875 Fault definition**, or an emergency stop input (X92 signal).

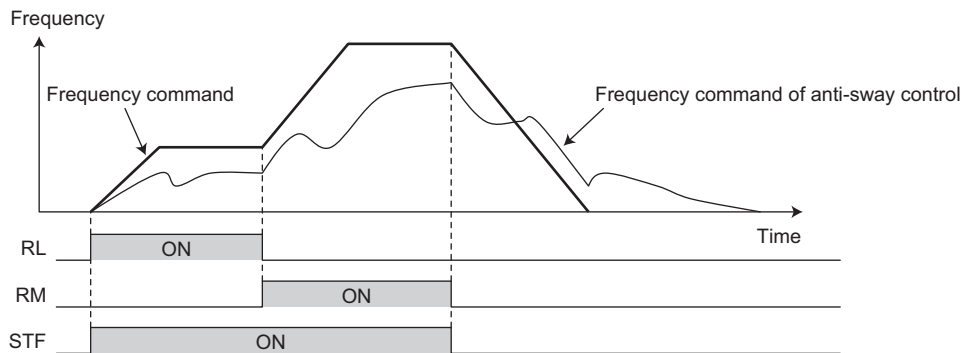

#### NOTE

- Under torque control or position control, the anti-sway control is disabled.
- During operation of the power failure time deceleration-to-stop function, or when the automatic restart after instantaneous power failure is enabled (**Pr.57** ≠ "9999"), the anti-sway control is disabled.

### ◆ Swinging frequency setting (Pr.1074 to Pr.1079)

- Set a swinging frequency in **Pr.1074 Anti-sway control frequency**. The swinging frequency is used as a notch filter frequency. Lower the response level of speed control in the frequency band with the width set in the **Pr.1076 Anti-sway control width** by the gain set in the **Pr.1075 Anti-sway control depth**.
- A deeper notch depth has a greater effect in reducing mechanical resonance, but because the phase delay is larger, swinging may increase. Adjust by starting from the shallowest value.

Setting	3	2	1	0
Gain (depth)	-4 dB (shallow)	-8 dB	-14 dB	-∞ (deep)

- If the **Pr.1076** setting is too large (the width is too wide), the response level of speed control drops, and the system may become unstable.
- After setting **Pr.1074** = "9999", set the crane rope length in the **Pr.1077 Rope length**, the trolley weight in the **Pr.1078 Trolley weight**, and the weight of an object in the **Pr.1079 Load weight**. Then, anti-sway control is performed using a swinging frequency estimated by the inverter.

### ◆ Delay time for brake operation of anti-sway control (Pr.1072)

- Set the time from when the output frequency becomes the **Pr.10 DC injection brake operation frequency** or less to when the zero speed control or the servo lock operation starts in the **Pr.1072 DC brake judgment time for anti-sway control operation**.

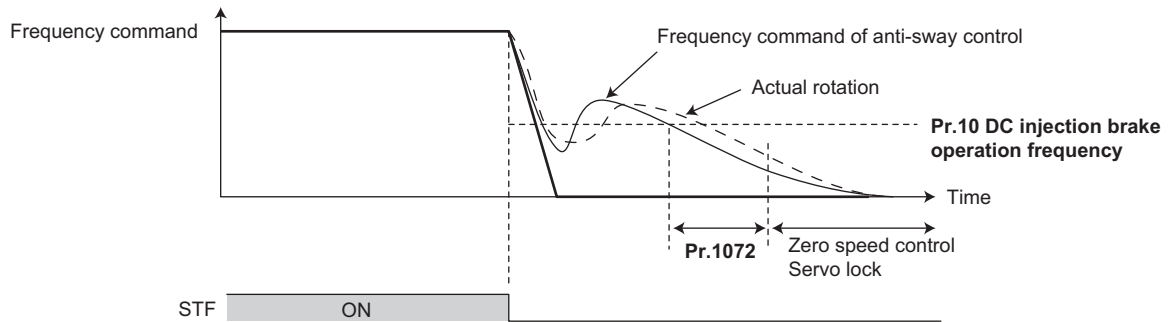

#### NOTE

- During anti-sway control operation, even if the motor rotation is restricted to one direction in the **Pr.78 Reverse rotation prevention selection**, the motor may rotate in a direction opposite to the setting.
- A protective function (E.OSD) may be activated during vibration control. When using anti-sway control, set **Pr.690 Deceleration check time** = "9999 (initial value)" to disable the deceleration check function.
- When anti-sway control is enabled, regeneration avoidance, shortest acceleration/deceleration, and the traverse function are disabled.
- Do not set anti-sway control and droop control together.

#### Parameters referred to

- Pr.10 DC injection brake operation frequency [page 715](#)
- Pr.78 Reverse rotation prevention selection [page 406](#)
- Pr.286 Droop gain [page 738](#)
- Pr.292 Automatic acceleration/deceleration [page 384](#)
- Pr.592 Traverse function selection [page 582](#)
- Pr.690 Deceleration check time [page 269](#)
- Pr.875 Fault definition [page 422](#)
- Pr.882 Regeneration avoidance operation selection [page 732](#)

## 5.14.9 Orientation control





The inverter can adjust the stop position (Orientation control) using a position detector (encoder) attached to a place such as the main shaft of the machine.

A Vector control compatible option is required.

Because **Pr.350 Stop position command selection** is initially set to "9999", the orientation control function is invalid.

Pr.	Name	Initial value	Setting range	Description
350 A510 <sup>*1</sup>	Stop position command selection	9999	0	Internal stop position command ( <b>Pr.356</b> )
			1	External stop position command (FR-A8AX 16-bit data)
			9999	Orientation control disabled
351 A526 <sup>*1</sup>	Orientation speed	2 Hz	0 to 30 Hz	Turning ON the X22 signal decelerates the motor speed to the set value.
352 A527 <sup>*1</sup>	Creep speed	0.5 Hz	0 to 10 Hz	After the speed reaches the orientation speed, the speed decreases to the creep speed set in <b>Pr.352</b> as soon as the current position pulse reaches the creep switchover position set in <b>Pr.353</b> .
353 A528 <sup>*1</sup>	Creep switchover position	511	0 to 16383	

Pr.	Name	Initial value	Setting range	Description		
354 A529 <sup>*1</sup>	Position loop switchover position	96	0 to 8191	As soon as the current position pulses reach the set position loop switchover position, control is changed to the position loop.		
355 A530 <sup>*1</sup>	DC injection brake start position	5	0 to 255	After the motor moves into the position loop, the motor stops by the DC injection brake when the current position pulses reach the specified start position of the DC injection brake.		
356 A531 <sup>*1</sup>	Internal stop position command	0	0 to 16383	When "0" is set in <b>Pr.350</b> , the internal position command is activated and the setting value of <b>Pr.356</b> becomes the stop position.		
357 A532 <sup>*1</sup>	Orientation in-position zone	5	0 to 255	Set the in-position width at a stop of the orientation.		
358 A533 <sup>*1</sup>	Servo torque selection	1	0 to 13	Operation at orientation completion can be selected.		
359 C141 <sup>*2</sup>	852 C241 <sup>*3</sup>	Encoder rotation direction	1	0	Set when using a motor for which forward rotation (encoder) is clockwise (CW) viewed from the shaft	Set for the operation at 120 Hz or less.
				100		Set for the operation at a frequency higher than 120 Hz.
				1	Set when using a motor for which forward rotation (encoder) is counterclockwise (CCW) viewed from the shaft.	Set for the operation at 120 Hz or less.
				101		Set for the operation at a frequency higher than 120 Hz.
360 A511 <sup>*1</sup>	16-bit data selection	0	0	Speed command	When <b>Pr.350</b> = "1" is set and the FR-A8AX is installed together, set the stop position using 16-bit data. The stop position command is input as binary regardless of the <b>Pr.304</b> setting.	
			1	16-bit data is used as the external position command as is.		
			2 to 127	Set the stop position by dividing up to 128 stop positions.		
361 A512 <sup>*1</sup>	Position shift	0	0 to 16383	Shift the home position using a compensation value without changing the home position of the encoder. The stop position is a position obtained by adding the setting of <b>Pr.361</b> to the position command.		
362 A520 <sup>*1</sup>	Orientation position loop gain	1	0.1 to 100	When the servo torque function is selected using <b>Pr.358</b> , the output frequency for generating servo torque gradually increases to the <b>Pr.352</b> according to the slope set in <b>Pr.362</b> . Although the operation becomes faster when the value is increased, hunting may occur in the machine.		
363 A521 <sup>*1</sup>	Completion signal output delay time	0.5 s	0 to 5 s	The Orientation complete (ORA) signal turns ON after going into the in-position width and waiting for the set time. Also, the signal turns OFF after going out of the in-position width and waiting for the set time.		
364 A522 <sup>*1</sup>	Encoder stop check time	0.5 s	0 to 5 s	If the Orientation complete (ORA) signal has never been output and the encoder stays stopped for the set time without completing orientation, the Orientation fault (ORM) signal is output. If the ORA signal has been output before but the orientation cannot be completed within the set time, the ORM signal is also output.		
365 A523 <sup>*1</sup>	Orientation limit	9999	0 to 60 s	The time elapses after passing the creep switchover position is measured. If orientation cannot be completed within the set time, the Orientation fault (ORM) signal is output.		
			9999	Set to 120 s.		
366 A524 <sup>*1</sup>	Recheck time	9999	0 to 5 s	When the start signal is turned OFF with the Orientation command (X22) ON after stopping the motor by orientation control, the present position is checked again after the set time elapses, and the Orientation complete (ORA) signal or Orientation fault (ORM) signal is output.		
			9999	Not checked.		
369 C140 <sup>*4</sup>	851 C240 <sup>*3</sup>	Number of encoder pulses	1024	0 to 4096	Set the number of encoder pulses. Set the number of pulses before it is multiplied by 4.	



Pr.	Name	Initial value	Setting range	Description
393 A525 <sup>*1</sup>	Orientation selection	0	0	Orientation is executed from the current rotation direction.
			1	Orientation from the forward rotation direction
			2	Orientation from the reverse rotation direction
			10	Orientation from the current rotation direction
			11	Orientation from the forward rotation direction
			12	Orientation from the reverse rotation direction
394 A540 <sup>*5</sup>	Number of machine side gear teeth	1	0 to 32767	Set the encoder orientation gear ratio.
395 A841 <sup>*5</sup>	Number of motor side gear teeth			
396 A542 <sup>*1</sup>	Orientation speed gain (P term)	60	0 to 1000	Response level during position control loop (servo rigidity) can be adjusted at orientation stop.
397 A543 <sup>*1</sup>	Orientation speed integral time	0.333	0 to 20 s	
398 A544 <sup>*1</sup>	Orientation speed gain (D term)	1	0 to 100	Lag/advance compensation gain can be adjusted.
399 A545 <sup>*1</sup>	Orientation deceleration ratio	20	0 to 1000	Make adjustment when the motor runs back at orientation stop or the orientation time is long.
829 A546 <sup>*7</sup>	Number of machine end encoder pulses	9999	0 to 4096	Set the number of pulses output from the encoder connected to the end of the machine. Set the number of pulses before it is multiplied by 4.
			9999	Machine end orientation invalid.
862 C242 <sup>*1</sup>	Encoder option selection	0	0	First motor: plug-in option that supports the Vector control Second motor: control terminal option that supports the Vector control <sup>*8</sup>
			1	First motor: control terminal option that supports the Vector control Second motor: plug-in option that supports the Vector control <sup>*8</sup>
				Motor end: control terminal option that supports the Vector control Machine end: plug-in option that supports the Vector control
				Machine end orientation invalid (when Pr.393 = "0, 1, or 2")
				Machine end orientation valid (when Pr.393 = "10, 11, or 12")

\*1 The setting is available when a Vector control compatible option is installed.

\*2 These parameters are available when a plug-in option (FR-A8AP/FR-A8AL/FR-A8APR/FR-A8APS) is installed.

\*3 These parameters are available when the option (FR-A8TP) is installed.

\*4 The setting is available when the FR-A8AP/FR-A8AL is installed.

\*5 The setting is available when the FR-A8AP/FR-A8AL/FR-A8APR/FR-A8TP is installed.

\*6 To perform machine end orientation, the plug-in option (FR-A8AP/FR-A8AL/FR-A8APR/FR-A8APS) and control terminal option (FR-A8TP) are required.

\*7 The setting is available when the FR-A8AL is installed.

\*8 When the second motor is selected, the orientation control is disabled.



## ◆ Motor end orientation connection example

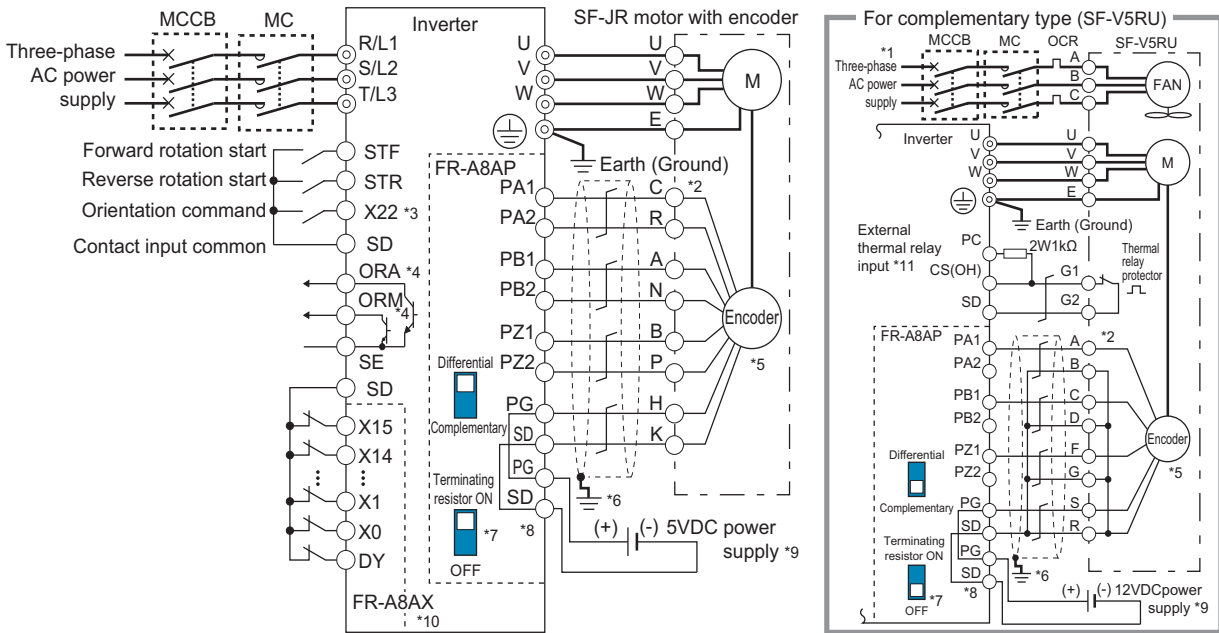

- \*1 Single-phase power supply (200 V/50 Hz, 200 to 230 V/60 Hz) is used for the fan for a 7.5 kW or lower dedicated motor.
- \*2 The pin number differs according to the used.
- \*3 Use **Pr.178 to Pr.189 (Input terminal function selection)** to assign the function to a terminal. (Refer to [page 521.](#))
- \*4 Use **Pr.190 to Pr.196 (Output terminal function selection)** to assign the function to a terminal. (Refer to [page 473.](#))
- \*5 Connect the encoder so that there is no looseness between the motor and motor shaft. Speed ratio must be 1:1.
- \*6 Connect the shield of the encoder cable to the enclosure using a tool such as a P-clip. (Refer to [page 93.](#))
- \*7 For the differential line driver, set the terminating resistor selection switch to the ON position (initial status) to use. (Refer to [page 88.](#))  
Note that the terminating resistor switch should be set to the OFF position when sharing the same encoder with another unit (NC, etc.) or when the terminating resistor is connected to another unit. For the complementary, set the switch to the OFF position.
- \*8 For terminal compatibility of the FR-JCBL, the FR-V5CBL, and the FR-A8AP, refer to [page 88.](#)
- \*9 A separate external power supply is necessary according to the encoder power specification. Make the voltage of the external power supply the same as the encoder output voltage, and connect the external power supply between terminals PG and SD. When performing encoder feedback control and Vector control together, an encoder and power supply can be shared.
- \*10 When a stop position command is input from outside, a plug-in option FR-A8AX is required. Refer to [page 589](#) for the external stop position command.
- \*11 Connect the recommended 2W1kΩ resistor between terminals PC and OH. (Recommended product: MOS2C102J 2W1kΩ by KOA Corporation) Insert the input line and the resistor to a 2-wire blade terminal, and connect the blade terminal to terminal OH. (For the recommended 2-wire blade terminals, refer to [page 74.](#))  
Insulate the lead wire of the resistor, for example by applying a contraction tube, and shape the wires so that the resistor and its lead wire do not touch other cables. Caulk the lead wire securely together with the thermal protector input line using a 2-wire blade terminal. (Do not subject the lead wire's bottom area to an excessive pressure.)  
To use a terminal as terminal OH, assign the External thermal relay input (OH) signal to an input terminal. (Set "7" in any of **Pr.178 to Pr.189.**)

When OH signal is assigned to terminal RH (**Pr.182 = "7"**)

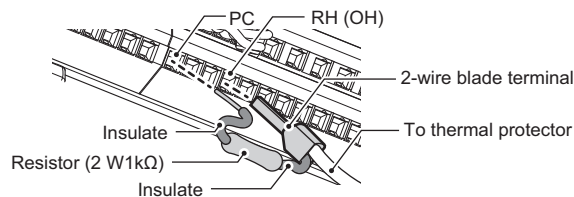

## ◆ Setting

- When the Orientation command (X22) signal is turned ON during operation after the parameters are set, the motor is decelerated to the orientation switchover speed. Then, the inverter calculates the orientation stop distance, further decelerates the motor and the motor enters the orientation state (servo lock). The Orientation complete (ORA) signal is output when the motor is within the orientation complete width.

## ◆ Setting I/O signals

Signal	Signal name	Description
X22	Orientation command	Turn ON the X22 signal to start the orientation operation. For the X22 signal input, set "22" in any of <b>Pr.178 to Pr.189</b> to assign the function.
ORA	Orientation complete	The output is in LOW state when the orientation stop can be made within the orientation complete width while the start signal and X22 signal are input (ON). For the ORA signal output, set "27 (positive logic)" or "127 (negative logic)" in <b>Pr.190 to Pr.196</b> .
ORM	Orientation fault	The output is in LOW state when the orientation stop cannot be made within the orientation complete width while the start signal and X22 signal are input (ON). For the ORM signal output, set "28 (positive logic)" or "128 (negative logic)" in <b>Pr.190 to Pr.196</b> .

## ◆ Selecting stop position command (Pr.350 Stop position command selection)

- Select either to use the internal stop position command (**Pr.356 Internal stop position command**) or the external stop position command (16-bit data using the FR-A8AX).

Pr.350 setting	Stop position command source
0	Internal stop position command ( <b>Pr.356: 0 to 16383</b> )
1	External stop position command (FR-A8AX) 16-bit data
9999 (initial value)	Orientation control disabled

- When the internal stop position command (**Pr.350 = "0"**) is selected, the **Pr.356** setting is used as the stop position.
- When the number of encoder pulses is 1024 pulses/r, one revolution (360°) of the encoder is divided by 4096 pulses (quadruplicated) so that the degree per pulse can be calculated as  
 $360^\circ / 4096 \text{ pulses} = 0.0879^\circ/\text{pulse}$ .

Refer to the following figure. Stop position (address) is shown within parentheses.

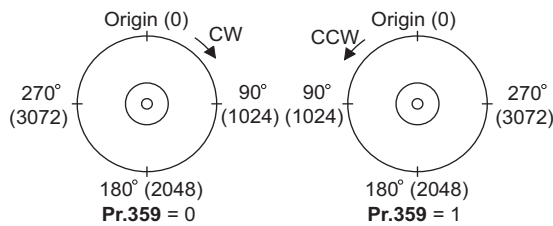

- When the external stop position command (**Pr.350 = "1"**) is selected while the FR-A8AX option is installed, 16-bit data (binary input) is used to give the stop position.
- The value set in **Pr.360 16-bit data selection** should be the divided value minus 1.

Pr.360 setting	Description
0	External position command is invalid (speed command or torque command via the FR-A8AX)
1	Position command direct input. The 16-bit digital signal via the FR-A8AX is the direct stop position command. <Example> When the <b>Pr.369 Number of encoder pulses</b> setting is "1024", the stop position command "0 to 4095" can be input using the FR-A8AX, and the digital signal of "2048 (H800)" is input to stop the motor at a 180° position. A command greater than 4096 is considered as 4095.
2 to 127	Set the stop position command by dividing up to 128 stop positions. If the external stop command input is greater than the setting, the stop positions are the same as those in the maximum external stop command value. <Example> When the number of stop positions is 90 (divided at intervals of 4°), $90 - 1 = 89$ . Hence, set "89".

[Example 1] When <b>Pr.369</b> = "1024"	[Example 2] With 8 stop positions	[Example 3] With 120 stop positions
<b>Pr.360 = "1"</b> 	<b>Pr.360 = "7"</b> 	<b>Pr.360 = "119"</b> 

**NOTE**

- Values in parentheses indicate binary data input from the terminals. Even if the position pulse monitor (**Pr.52 Operation panel main monitor selection = "19"**) is selected, the data monitored is not the number of stop positions. It is the number of pulses from 0 to 65535.
- FR-A8AX parameters (**Pr.300 to Pr.305**) are invalid. (Valid when **Pr.360 = "0"**)
- Terminal DY (data read timing input signal) becomes invalid during Vector control. (The position data is downloaded at the start of orientation.)
- Internal stop position command is given when no option is installed or **Pr.360 = "0"** even if "1" (external stop position command) is set in **Pr.350**.

- Relationship between stop position command and 16-bit data

Pr.350 Stop position command selection	Pr.360 16-bit data selection	Operation		
		Stop position command	16-bit data (FR-A8AX)	Speed command
0: internal	0: speed command	Internal ( <b>Pr.356</b> )	Speed command	16-bit data
	1, 2 to 127: position command	Internal ( <b>Pr.356</b> )	Disabled	External command (or PU)
1: EXT	0: speed command	Internal ( <b>Pr.356</b> )	Speed command	16-bit data
	1, 2 to 127: position command	External (Internal when the FR-A8AX is not installed ( <b>Pr.356</b> ))	Position command	External command (or PU)

**◆ Pr.361 Position shift (initial value "0")**

- The stop position is a position obtained by adding the setting of **Pr.361** to the position command.
- Position shift function

Shift the home position using a compensation value without changing the home position of the position detector (encoder).

**NOTE**

- When orientation control is valid using **Pr.350 Stop position command selection** with the Vector control compatible option installed, the rotation direction of the encoder is displayed on the rotation direction display of the PU (operation panel/parameter unit).  
Make settings so that "FWD" is displayed at turn ON of the STF signal and "REV" is displayed at turn ON of the STR signal.

**◆ Monitor display change**

Monitor	Remarks
Position pulse monitor	When "19" is set in <b>Pr.52 Operation panel main monitor selection</b> , the position pulse monitor is displayed instead of the output voltage monitor of the PU. (Displayed only when the Vector control compatible option is mounted.)
Orientation status <sup>*1</sup>	When "22" is set in <b>Pr.52</b> , the orientation status is displayed instead of the output voltage monitor of the PU. (Displayed only when the Vector control compatible option is mounted.) 0: Other than orientation operation or orientation speed is not reached 1: Orientation speed is reached 2: Creep speed is reached 3: Position loop is reached 4: Orientation complete 5: Orientation fault (pulse stop) 6: Orientation fault (orientation limit) 7: Orientation fault (recheck) 8: Continuous multi-point orientation

\*1 Invalid during Vector control. ("0" is always displayed.)

**◆ Pr.357 Orientation in-position zone (initial value "5")**

- The in-position width for orientation stop can be set.

The initial value of **Pr.357** is "5". To change the  $\Delta\theta$  value, make fine adjustments by changing in increments of  $\pm 10$ .

- If the position detection value from the encoder enters  $\pm\Delta\theta$  during orientation stop, the Orientation complete (ORA) signal is output.

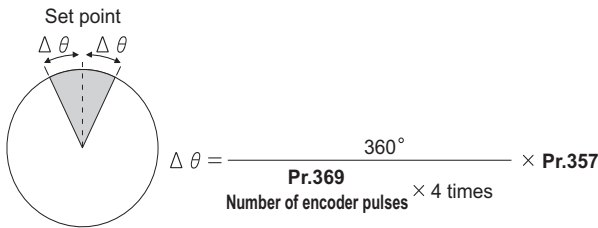

## ◆ Orientation at the running status (under V/F control, Advanced magnetic flux vector control)

1. When the orientation command (X22) turns on, the motor speed decreases to the **Pr.351 Orientation speed**. (Pr.351 is initially set to: 2 Hz)
2. After the speed reaches the orientation speed, the speed further decreases to the **Pr.352 Creep speed** as soon as the current position pulse reaches the **Pr.353 Creep switchover position**. (Pr.352 is initially set to 0.5 Hz, Pr.353 is initially set to "511".)
3. Moreover, as soon as the current position pulse reaches the **Pr.354 Position loop switchover position**, control is changed to the position loop. (Pr.354 is initially set to "96".)
4. After the motor moves into the position loop, the motor decelerates and stops by the DC injection brake as soon as the current position pulse reaches the **Pr.355 DC injection brake start position**. (Pr.355 is initially set to "5".)
5. When the motor stops in **Pr.357 Orientation in-position zone**, the orientation complete (ORA) signal is output after **Pr.363 Completion signal output delay time**. If the motor does not stop within the in-position width because of external force, etc., the ORA signal turns OFF after the time set in **Pr.363**. (Pr.357 is initially set to "5", Pr.363 is initially set to 0.5 s.)
6. If the orientation is not completed continuously in **Pr.365 Orientation limit** after passing the creep switchover position, the orientation fault signal (ORM) is output.
7. After the orientation starts, if the motor is stopped by external force, etc. before reaching the in-position width and the ORA signal is not output, the ORM signal is output after the **Pr.364 Encoder stop check time**. If the motor is moved out of the in-position width by external force, etc. after the ORA signal has been output once, the ORA signal turns OFF after the set time in **Pr.363**. If the orientation is not completed within the time set in **Pr.364**, the ORM signal is output.
8. If the ORA and ORM signals have been output once, but the start signal (STF or STR) is turned OFF while the X22 signal is ON, the ORA or ORM signal is output again after **Pr.366 Recheck time**.
9. The ORA and ORM signals cannot be output while the X22 signal is OFF.

**NOTE**

- When the orientation command turns OFF while the start signal is ON, the speed accelerates to the command speed.

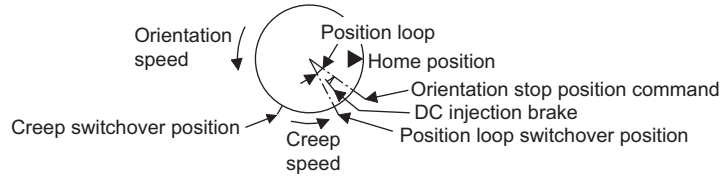

- If hunting of the motor shaft occurs during orientation stop, set a larger value in **Pr.354** or a smaller value in **Pr.352** to prevent it.

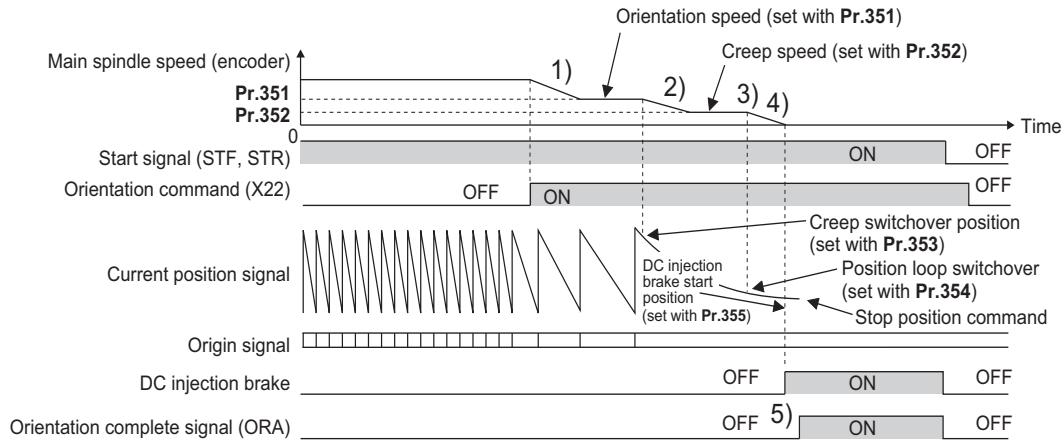

**◆ Orientation from the stop status (under V/F control, Advanced magnetic flux vector control)**

- Turning ON the start signal after turning ON the Orientation command (X22) signal increases the motor speed to the **Pr.351 Orientation speed**, and then the same orientation operation is performed as the operation shown in "Orientation at the running status".
- Note that the DC injection brake operates without increasing to the orientation speed if the position signal is within the DC injection brake start position.

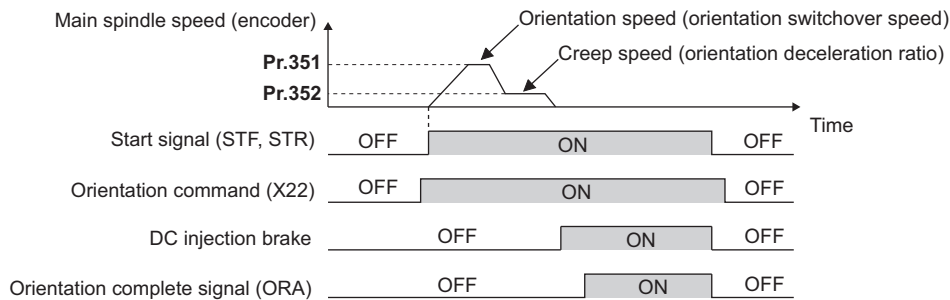

## ◆ Continuous multi-point orientation (V/F control, Advanced magnetic flux vector control)

- Orientation during orientation operation or start signal is ON

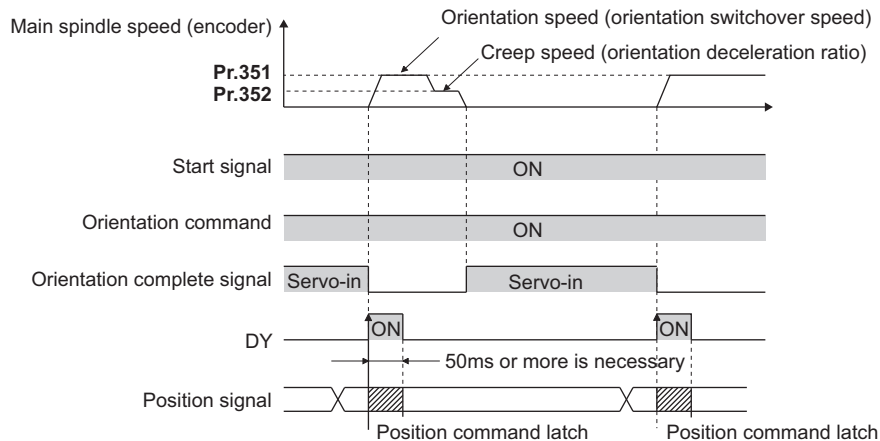

- The position data is read at the rising edge of DY. (For the details, refer to the Instruction Manual of FR-A8AX).
- When the position signal is within the creep switchover position, the speed starts up to the creep speed not to the orientation speed.
- When the position signal is outside the creep switchover position, the speed starts up to the orientation speed.
- The DC injection brake operates if the position signal is within the DC injection brake start position.
- 16-bit data with the FR-A8AX is valid only when the DY signal is ON.

### NOTE

- Couple the encoder with the motor shaft or with the shaft that stops the main shaft at the specified position. Couple it with the speed ratio of 1:1 and without any mechanical looseness.
- The DC injection brake operates at orientation stop. Release the DC injection brake as soon as possible (within several seconds), as continuous operation of the DC injection brake will cause the motor to overheat, leading to burnout.
- Because the servo lock function is not available after orientation stop, provide a holding mechanism, such as a mechanical brake or knock pin, when secure holding of the main shaft is required.
- To ensure correct positioning, the encoder must be set in the proper rotation direction, and the A and B phases must be connected correctly.
- If the pulse signal from the encoder stops due to encoder signal loss, etc. during orientation, the Orientation fault (ORM) signal may be output.
- When performing orientation control, enable the DC injection brake (refer to [page 715](#)). When the DC injection brake is disabled, orientation operation cannot be completed.
- When orientation control is performed, the DC injection brake operates regardless of the External DC injection brake operation start (X13) signal even when **Pr.11 DC injection brake operation time** = "8888" (DC injection brake external selection).
- To terminate orientation, the start signal (STF or STR) must be first switched OFF, and then the Orientation command (X22) signal must be switched OFF. As soon as this X22 signal is switched OFF, orientation control ends. (Depending on the **Pr.358 Servo torque selection** setting, the orientation status continues if the X22 signal remains ON even if the DC injection brake is released by turning OFF the start signal. Because of this, the orientation status on the monitor does not show "0".)
- When the retry function of **Pr.358 Servo torque selection** is selected, the retry operation is performed three times including the first orientation.
- When performing orientation control, properly set **Pr.350 Stop position command selection** and **Pr.360 16-bit data selection (external position command selection)**. If the values set are incorrect, proper orientation control will not be performed.
- When orientation control is performed, PID control is disabled.

## ◆ Servo torque selection (Pr.358) (V/F control, Advanced magnetic flux vector control)

Function and description	Operation for each Pr.358 setting													Remarks	
	0	1	2	3	4	5	6	7	8	9	10	11	12		13
a. Servo torque function until output of the Orientation complete (ORA) signal	x	o	o	o	o	x	o	x	o	x	o	x	x	o	o: With servo torque function. x: Without servo torque function.
b. Retry function	x	x	x	x	x	x	x	o	x	x	x	o	x	x	o: With retry function. x: Without retry function.
c. Output frequency compensation when the motor stops outside the in-position zone	x	x	o	o	x	o	o	x	x	x	x	x	o	o	o: With frequency compensation. x: Without frequency compensation.
d. DC injection brake and servo torque when the motor exits the in-position zone after output of the Orientation complete (ORA) signal	o	x	x	x	x	o	o	o	o	o	o	o	o	o	o: DC injection brake enabled. x: Servo torque enabled.
e. Turning OFF the Orientation complete (ORA) signal when the orientation operation is ended.	o	o	o	x	x	o	o	o	o	x	x	x	x	x	o: When the start signal (STF, STR) or orientation command is turned OFF. x: When the orientation command is turned OFF.
f. Complete signal when the motor exits the in-position zone after output of the Orientation complete (ORA) signal	o	o	o	o	o	x	x	x	x	x	x	x	x	x	o: Turns OFF the complete signal when the motor exits the in-position zone. x: Complete signal remains ON even if the motor exits the in-position zone (the Orientation fault (ORM) signal is not output).

**NOTE**

- When the orientation command turns OFF while the start signal is ON, the motor accelerates to the command speed.
- When the motor shaft stops outside of the set setting range of the stop position, the motor shaft is returned to the stop position by the servo torque function (if enough torque is generated).

- Servo torque function until output of the Orientation complete signal**  
Select whether or not servo torque is available using **Pr.358 Servo torque selection**. Servo torque is not generated if the current position pulse is in between the orientation stop position and DC injection brake start position. The shaft is fixed using the DC injection brake, and when the motor exits the width by external force, etc., the servo torque is generated to move the motor back within the width. Once the Orientation complete (ORA) signal is output, the operation is performed as described in d.
- Retry function**  
Select retry function using **Pr.358**. Note that the retry function cannot be used together with the servo torque function. If the motor shaft does not stop within the in-position zone when the motor stop is checked, orientation operation is performed again by the retry function. This retry function is performed three times including the first orientation. The maximum retry number is three. (The Orientation fault (ORM) signal is not output during retry operation.)
- Frequency compensation when the motor stops outside the orientation complete width**  
When the motor stops before entering the in-position width due to external force, etc., the output frequency is increased to move the shaft to the orientation stop position. The output frequency is gradually increased to the **Pr.352 Creep speed**. This function cannot be used with the retry function.
- DC injection brake and servo torque selection when the position pulse exits the in-position zone after output of the ORA signal**  
If the motor exits the in-position width, select the setting either to fix the shaft with the DC injection brake or by returning the motor to the orientation stop position with the servo torque.
- Turning OFF the Orientation complete (ORA) signal when the orientation operation is ended.**  
When ending the orientation operation, first turn OFF the start (STF or STR) signal, and then turn OFF the Orientation command X22 signal. At this time, select when to turn OFF the ORA signal from either the time the start signal is turned OFF or the time the orientation command signal is turned OFF.
- Complete signal when the motor exits the in-position zone after output of the Orientation complete (ORA) signal**  
Select to turn OFF the ORA signal or to keep the ORA signal ON (the ORM signal is not output) when the motor exits the in-position width.

### ◆ Position loop gain (Pr.362) (V/F control, Advanced magnetic flux vector control)

- When the servo torque function is selected using **Pr.358 Servo torque selection**, the output frequency for generating servo torque gradually increases to the **Pr.352 Creep speed** according to the slope set in **Pr.362 Orientation position loop gain**.
- Although the operation becomes faster when the value is increased, hunting may occur in the machine.



## ◆ Description of orientation operation (Vector control)

- Setting the rotation direction (**Pr.393 Orientation selection**)

Pr.393 setting	Rotation direction	Remarks
0 (initial value)	Pre-orientation	Orientation is executed to the current rotation direction.
1	Forward rotation orientation	Orientation is executed to the forward rotation direction. (If the motor is running in reverse, orientation is executed to the forward rotation direction after deceleration.)
2	Reverse rotation orientation	Orientation is executed to the reverse rotation direction. (If the motor is running forward, orientation is executed to the reverse rotation direction after deceleration.)
10	Pre-orientation	Orientation is executed to the current rotation direction.
11	Forward rotation orientation	Orientation is executed to the forward rotation direction. (If the motor is running in reverse, orientation is executed to the forward rotation direction after deceleration.)
12	Reverse rotation orientation	Orientation is executed to the reverse rotation direction. (If the motor is running forward, orientation is executed to the reverse rotation direction after deceleration.)

## ◆ Orientation to the current rotation direction (Pr.393 = "0 (initial value), 10") (Vector control)

- When the Orientation command (X22) signal is input, the motor speed decelerates from the running speed to **Pr.351 Orientation speed**. At the same time, the orientation stop position command is read in. (The stop position command is determined by the setting of **Pr.350 Stop position command selection, Pr.360 16-bit data selection**.)



- When the orientation switchover speed is reached, the encoder Z phase pulse is confirmed, and the control changes from speed control to position control (**Pr.362 Orientation position loop gain**).
- The distance to the orientation stop position is calculated at switching of the control, and the motor decelerates to a stop with a set deceleration pattern (**Pr.399 Orientation deceleration ratio**) and enters the orientation (servo lock) state.
- Once in the **Pr.357 Orientation in-position zone**, the Orientation complete (ORA) signal is output.
- The home position can be moved using **Pr.361 Position shift**.

### CAUTION

- If the X22 is turned OFF while the start signal is input, the motor accelerates toward the speed of the current speed command. Therefore, to stop, turn the Forward rotation (Reverse rotation) signal OFF.

## ◆ Orientation to the forward rotation direction (Pr.393 = "1, 11") (Vector control)

- This method is used to improve the stopping precision and maintain the mechanical precision when the backlash is large.
- If the motor is running in the forward rotation direction, it makes an orientation stop with the same method as "orientation to the current rotation direction".

- If the motor is running in reverse, it decelerates, change to the forward rotation direction, and then orientation stop is executed.

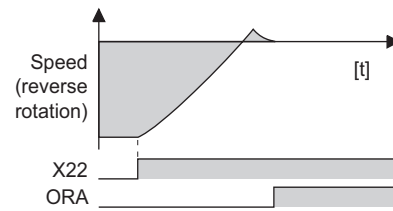
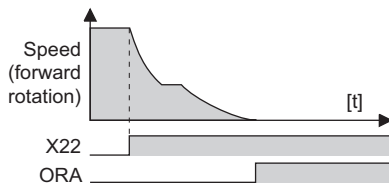

## ◆ Orientation to the reverse rotation direction (Pr.393 = "2, 12") (Vector control)

- If the motor is running in the reverse rotation direction, it executes an orientation stop with the same method as "orientation to the current rotation direction".
- If the motor is running in forward, it decelerates, change to the reverse rotation direction, and then orientation stop is executed.

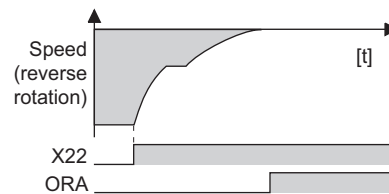
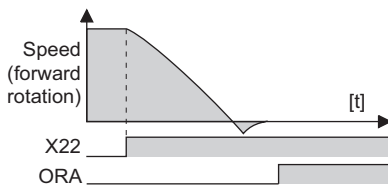

### NOTE

- Couple the encoder with the motor shaft that stops the shaft at the specified position. Couple it with the speed ratio of 1:1 and without any mechanical looseness.
- To ensure correct positioning, the encoder must be set in the proper rotation direction, and the A and B phases must be connected correctly.
- If the pulse signal from the encoder stops due to encoder signal loss, etc. during orientation, orientation may not be completed.
- To terminate orientation, the start (STF or STR) signal must be first switched OFF, and then the Orientation (X22) signal must be switched OFF. As soon as this X22 signal is switched OFF, orientation control ends.
- When performing orientation control, properly set **Pr.350 Stop position command selection** and **Pr.360 16-bit data selection**.  
If the values set are incorrect, proper orientation control will not be performed.
- When orientation control is performed, PID control is disabled.
- If Signal loss detection (E.ECT) is displayed when the X22 signal is ON, causing the inverter to trip, check for a break in the cable of the Z phase of the encoder.

## ◆ Servo rigidity adjustment (Pr.362, Pr.396 to Pr.398) (Vector control)

- To increase the servo rigidity<sup>\*1</sup> during orientation stop using **Pr.396 Orientation speed gain (P term)** or **Pr.397 Orientation speed integral time**, make adjustments with the following procedures.

**1.** Increase the **Pr.362 Orientation position loop gain** value to the extent that rocking<sup>\*2</sup> does not occur during orientation stop.

**2.** Increase **Pr.396** and **Pr.397** at the same rate.

Normally, adjust **Pr.396** in the range from 10 to 100, and **Pr.397** from 0.1 to 1.0 s.

(Note that these do not need to be set to the same rate.)

<Example>

When the **Pr.396** value is multiplied by 1.2, divide the **Pr.397** value by 1.2.

If vibration occurs during orientation stop, the scale cannot be raised any higher.

### 3. Pr.398 Orientation speed gain (D term) is the lag/advance compensation gain.

The limit cycle<sup>\*3</sup> can be prevented by increasing the value, and operation can be stopped stably. However, the torque decreases in relation to the position deviation, and the motor stops with deviation.

- \*1 Servo rigidity: The response when a position control loop is configured.  
When the servo rigidity is raised, the holding force increases and operation becomes stabilized, but vibration occurs more easily.  
When the servo rigidity is lowered, the holding force decreases, and the settling time increases.
- \*2 Rocking: Movement in which return occurs when the stopping position is exceeded.
- \*3 Limit cycle: This is a phenomenon that generates  $\pm$  continuous vibration centering on the target position.

#### Point

- Application of lag/advance control and PI control  
PI control can be applied by setting **Pr.398** to 0. Normally, use the lag/advance control. PI control should be used when using a machine with a high spindle static friction torque and requires a stop position accuracy.

### ◆ Pr.399 Orientation deceleration ratio (initial value: 20) (Vector control)

- Make adjustments, as shown below, according to the orientation status. (Make adjustments in the order of a, b, and c.)  
Normally, adjust **Pr.362 Orientation position loop gain** in the range from 5 to 20, and **Pr.399 Orientation deceleration ratio** from 5 to 50.

Condition	Adjustment procedure
Rocking occurs during stopping	a. Decrease the <b>Pr.399</b> setting. b. Decrease the <b>Pr.362</b> setting. c. Increase the <b>Pr.396</b> and <b>Pr.397</b> settings.
The orientation time is long.	a. Increase the <b>Pr.399</b> setting. b. Increase the <b>Pr.362</b> setting.
Hunting occurs during stopping	a. Decrease the <b>Pr.362</b> setting. b. Decrease the <b>Pr.396</b> setting and increase the <b>Pr.397</b> setting.
Low servo rigidity during stopping	a. Increase the <b>Pr.396</b> setting and decrease the <b>Pr.397</b> setting. b. Increase the <b>Pr.362</b> setting.

#### NOTE

- Orientation stop operation fails, causing an excessive position error, or if the motor performs forward/reverse reciprocation operation, review the settings of **Pr.393 Orientation selection** (on page 587) and **Pr.359 Encoder rotation direction** (on page 586).

### ◆ Pr.351 Orientation speed (initial value: 2 Hz) (Vector control)

- Set the speed when switching between the speed control mode and the position control mode is performed under orientation operation.

Decreasing the set speed enables stable orientation stop. Note that the orientation time increases.

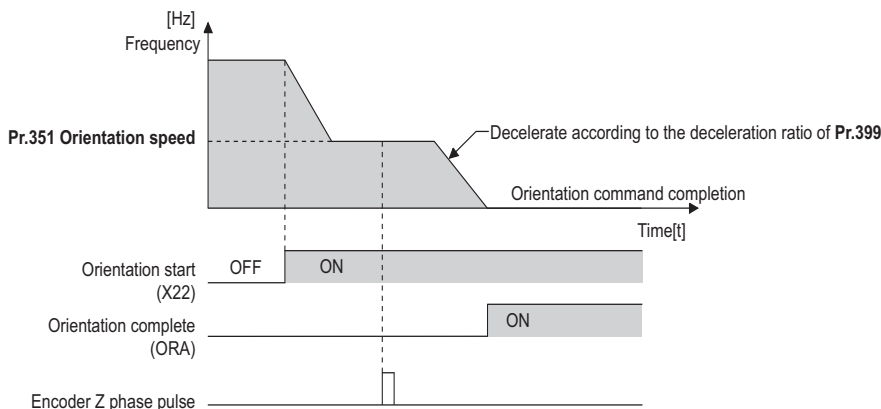

#### NOTE

- When "19" is set in **Pr.52 Operation panel main monitor selection**, the position pulse monitor is displayed instead of the output voltage monitor on the PU.

## ◆ Machine end orientation connection diagram (Vector control)

- To perform machine end orientation control, the following settings are required.
  - Install a plug-in option (FR-A8AP/FR-A8AL or FR-A8APR) and a control terminal option (FR-A8TP) to the inverter, a motor end encoder to the control terminal option, and a machine end encoder to the plug-in option.
  - Set "1" in **Pr.862 Encoder option selection**.
  - Set **Pr.393 Orientation selection** = "10 to 12". (Refer to [page 596](#).)
  - Set the gear ratio by setting **Pr.394 Number of machine side gear teeth** and **Pr.395 Number of motor side gear teeth**. (Refer to [page 599](#).)

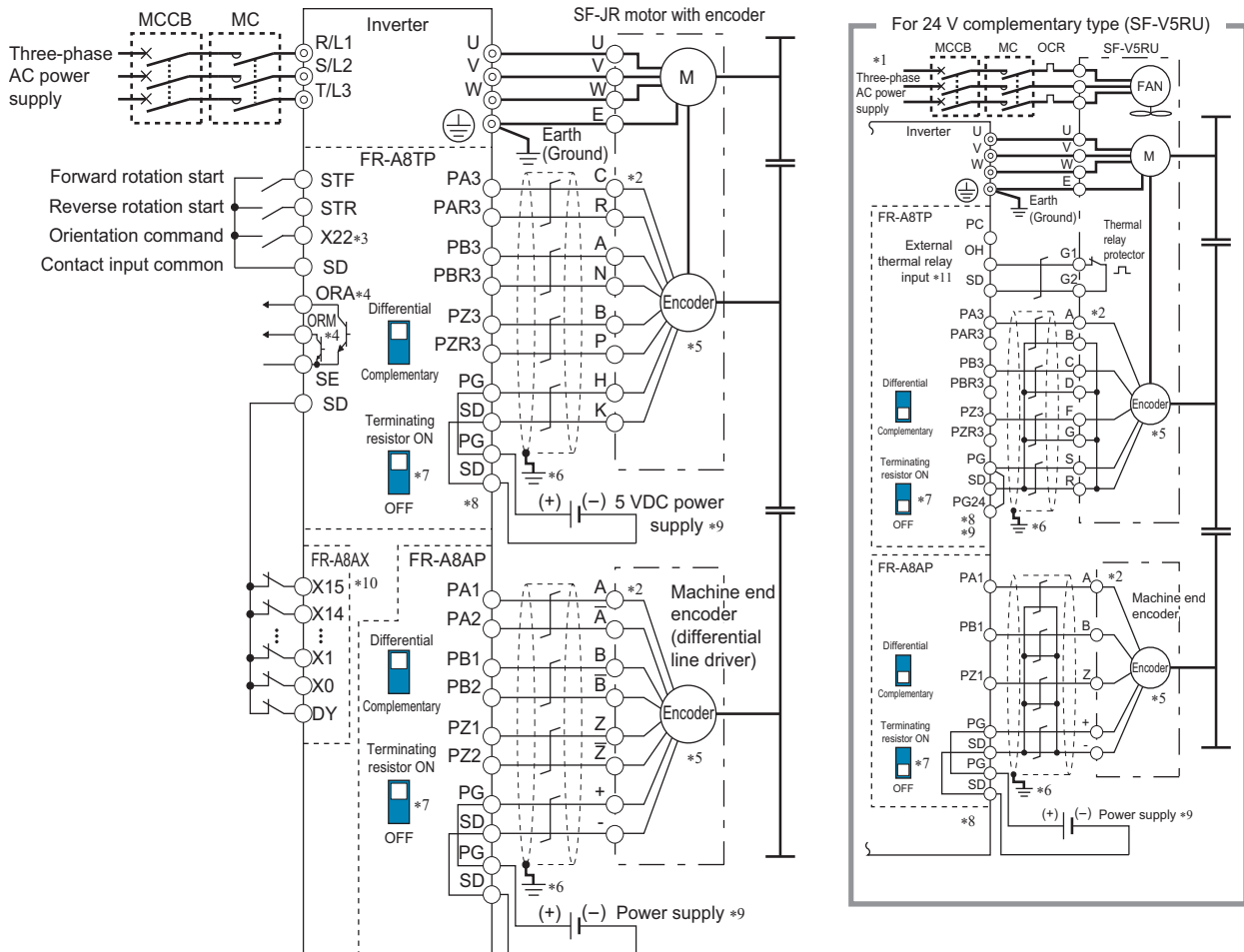

- \*1 Single-phase power supply (200 V/50 Hz, 200 to 230 V/60 Hz) is used for the fan for a 7.5 kW or lower dedicated motor.
- \*2 The pin number differs according to the encoder used.
- \*3 Use **Pr.178 to Pr.182, Pr.185, or Pr.189 (Input terminal function selection)** to assign the function to a terminal. (Refer to [page 521](#).)
- \*4 Use **Pr.190 to Pr.192, or Pr.195 (Output terminal function selection)** to assign the function to a terminal. (Refer to [page 473](#).)
- \*5 Connect the encoder so that there is no looseness between the motor and motor shaft. Speed ratio must be 1:1.
- \*6 Earth (ground) the shield of the encoder cable to the enclosure using a tool such as a P-clip. (Refer to [page 88](#).)
- \*7 For the differential line driver, set the terminating resistor selection switch to the ON position. (Refer to [page 93](#).)  
Note that the terminating resistor switch should be set to the OFF position (initial status) when sharing the same encoder with another unit (NC, etc.) having a terminating resistor under the differential line driver setting.  
For the complementary, set the switch to the OFF position.
- \*8 For terminal compatibility between the FR-A8TP and the FR-JCBL/FR-V7CBL, refer to the Instruction Manual of the FR-A8TP.
- \*9 A separate external power supply is necessary according to the encoder power specification. When the encoder output is the differential line driver type, only 5 V can be input. Make the voltage of the external power supply the same as the encoder output voltage, and connect the external power supply between terminals PG and SD. If using the 24V power supply of the FR-A8TP, 24V power can be supplied from terminal PG24. When performing encoder feedback control and Vector control together, an encoder and power supply can be shared.
- \*10 When a stop position command is input from outside, a plug-in option FR-A8AX is required. Refer to [page 589](#) for the external stop position command.
- \*11 To enable terminal OH, set Pr.876 Thermal protector input = "1 (initial value)". (Refer to [page 420](#).)

## ◆ Encoder orientation gear ratio setting (Pr.394, Pr.395) (Vector control)

- Set the encoder orientation gear ratio for machine end orientation control.

- Set the encoder orientation gear ratio in **Pr.394 Number of machine side gear teeth**, **Pr.395 Number of motor side gear teeth**. An accurate gear ratio (or pulley ratio) from the motor shaft to the spindle is necessary.

Set the correct numbers of gear teeth in **Pr.394** and **Pr.395**.

$$\text{Pr.394} = A \times C \times E$$

$$\text{Pr.395} = B \times D \times F$$

Exercise care so that the  $A \times C \times E$  and  $B \times D \times F$  settings do not exceed 32767. If either or both of them exceed that value, make approximations.

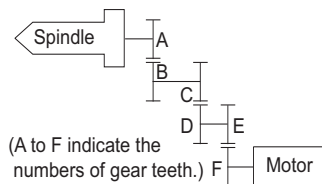

### NOTE

- Pulley ratio: Ratio of vector-driven motor side pulley diameter to spindle side pulley diameter

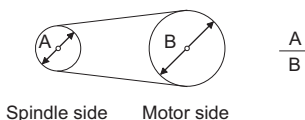

- Setting example (When the numbers of gear teeth are as follows)

A: 15, C: 43, E: 60, B: 10, D: 28, F: 55

$$\text{Pr.394} = 15 \times 43 \times 60 = 38700$$

$$\text{Pr.395} = 10 \times 28 \times 55 = 15400$$

Since **Pr.394** setting exceeds 32767 at this time, make approximations as follows.

$$\text{Pr.394/Pr.395} = 38700/15400 = 3870/1540$$

## ◆ Machine end simple orientation control

- Machine end simple orientation control is available when the FR-A8AL option is installed on the inverter and connected to a machine end encoder. Both machine end orientation control and encoder feedback control/ Vector control is also enabled at the same time.
- Set the orientation speed at the motor end encoder in **Pr.351 Orientation speed**.
- Set the rotation direction of the encoder in **Pr.359 Encoder rotation direction**. If the rotation directions of the motor end encoder and the machine end encoder differ, set the rotation direction of the motor end encoder.
- To perform encoder feedback control or Vector control using the machine end encoder, set **Pr.369 Number of encoder pulses** with the number of motor end encoder pulses converted from the number of machine end encoder pulses.
- To enable encoder feedback control or Vector control and machine end orientation control at the same time using the machine end encoder, set the number of machine end encoder pulses in **Pr.829 Number of machine end encoder pulses** and "0" in **Pr.862 Encoder option selection**.

Pr.829 setting	Pr.862 setting	Description
9999	—	Machine end simple orientation control invalid
Other than 9999 (The number of machine end encoder pulses (before multiplied by four) is set.)	0	Encoder feedback control / Vector control and machine end orientation control at the same time using the machine end encoder is enabled.
	1	Machine end simple orientation control invalid

- When the number of machine end encoder pulses is 4000 and the gear ratio between motor end and machine end is 4:1 (4 rotations of motor equals one rotation of machine), set the value as **Pr.369** = "1000", **Pr.829** = "4000" (the number of machine end encoder pulses) according to the following formula,  
The equivalent of number of motor end encoder pulses =  $4000 \times 1/4 = 1000$

### NOTE

- For other settings, refer to descriptions of motor end orientation control in this manual.

## 5.14.10 PID control

Process control such as flow rate, air volume or pressure are possible on the inverter.

A feedback system can be configured and PID control can be performed using the terminal 2 input signal or parameter setting value as the set point and the terminal 4 input signal as the feedback value.

Pr.	Name	Initial value	Setting range	Description
127 A612	PID control automatic switchover frequency	9999	0 to 590 Hz	Set the value at which control is automatically switched to PID control.
			9999	No PID control automatic switchover function
128 A610	PID action selection	0	0, 10, 11, 20, 21, 50, 51, 60, 61, 70, 71, 80, 81, 90, 91, 100, 101, 1000, 1001, 1010, 1011, 2000, 2001, 2010, 2011	Select how to input the deviation value, measured value and set point, and forward and reverse action.
			40 to 43	Refer to <a href="#">page 622</a> .
129 A613	PID proportional band	100%	0.1 to 1000%	If a narrow proportional band is set (small parameter setting value), the manipulated amount changes considerably by slight changes in the measured value. As a result, response improves as the proportional band becomes narrower, though stability worsens as shown by the occurrence of hunting. Gain $K_p=1/\text{proportional band}$
			9999	No proportional control
130 A614	PID integral time	1 s	0.1 to 3600 s	With deviation step input, this is the time (Ti) used for obtaining the same manipulated amount as proportional band (P) by only integral (I) action. Arrival to the set point becomes quicker the shorter an integral time is set, though hunting is more likely to occur.
			9999	No integral control
131 A601	PID upper limit	9999	0 to 100%	Set the upper limit. The FUP signal is output when the feedback value exceeds this setting. The maximum input (20 mA/5 V/10 V) of the measured value is equivalent to 100%.
			9999	No function
132 A602	PID lower limit	9999	0 to 100%	Set the lower limit. The FDN signal is output when the measured value falls below the setting range. The maximum input (20 mA/5 V/10 V) of the measured value is equivalent to 100%.
			9999	No function
133 A611	PID action set point	9999	0 to 100%	Set the set point during PID control.
			9999	Set point set by <b>Pr.128</b> .
134 A615	PID differential time	9999	0.01 to 10 s	With deviation ramp input, this is the time (Td) used for obtaining the manipulated amount only by proportional action (P). Response to changes in deviation increase greatly as the differential time increases.
			9999	No differential control
553 A603	PID deviation limit	9999	0 to 100%	The Y48 signal is output when the absolute value of the deviation exceeds the deviation limit value.
			9999	No function
554 A604	PID signal operation selection	0	0 to 3, 10 to 13	The action when the upper or lower limit for a measured value input is detected or when a limit for the deviation is detected can be selected. The operation for PID output suspension function can be selected.
575 A621	Output interruption detection time	1 s	0 to 3600 s	When the output frequency after PID calculation stays less than the <b>Pr.576</b> setting for the time set in <b>Pr.575</b> or more, the inverter operation is suspended.
			9999	No output interruption function
576 A622	Output interruption detection level	0 Hz	0 to 590 Hz	Set the frequency at which output interruption is performed.
577 A623	Output interruption cancel level	1000%	900 to 1100%	Level at which the PID output suspension function is released. Set " <b>Pr.577</b> - 1000%".
609 A624	PID set point/deviation input selection	2	1	The set point or deviation value is input through terminal 1.
			2	The set point or deviation value is input through terminal 2.
			3	The set point or deviation value is input through terminal 4.
			4	The set point or deviation value is input via communication.
			5	The set point or deviation value is input by the PLC function.

Pr.	Name	Initial value	Setting range	Description
610 A625	PID measured value input selection	3	1	The measured value is input through terminal 1.
			2	The measured value is input through terminal 2.
			3	The measured value is input through terminal 4.
			4	The measured value is input via communication.
			5	The measured value is input by the PLC function.
1015 A607	Integral stop selection at limited frequency	0	0	Integral stopped at the limit, manipulation range of $\pm 100\%$ , integral cleared during output interruption
			1	Integral continued at the limit, manipulation range of $\pm 100\%$ , integral cleared during output interruption
			2	Integral stopped at the limit, manipulation range of 0 to 100%, integral cleared during output interruption
			10	Integral stopped at the limit, manipulation range of $\pm 100\%$ , integral stopped during output interruption
			11	Integral continued at the limit, manipulation range of $\pm 100\%$ , integral stopped during output interruption
			12	Integral stopped at the limit, manipulation range of 0 to 100%, integral stopped during output interruption
753 A650	Second PID action selection	0	0, 10, 11, 20, 21, 50, 51, 60, 61, 70, 71, 80, 81, 90, 91, 100, 101, 1000, 1001, 1010, 1011, 2000, 2001, 2010, 2011	Refer to <b>Pr.128</b> .
754 A652	Second PID control automatic switchover frequency	9999	0 to 590 Hz, 9999	Refer to <b>Pr.127</b> .
755 A651	Second PID action set point	9999	0 to 100%, 9999	Refer to <b>Pr.133</b> .
756 A653	Second PID proportional band	100	0.1 to 1000%, 9999	Refer to <b>Pr.129</b> .
757 A654	Second PID integral time	1 s	0.1 to 3600 s, 9999	Refer to <b>Pr.130</b> .
758 A655	Second PID differential time	9999	0.01 to 10 s, 9999	Refer to <b>Pr.134</b> .
1140 A664	Second PID set point/ deviation input selection	2	1 to 5	Refer to <b>Pr.609</b> .
1141 A665	Second PID measured value input selection	3	1 to 5	Refer to <b>Pr.610</b> .
1143 A641	Second PID upper limit	9999	0 to 100%, 9999	Refer to <b>Pr.131</b> .
1144 A642	Second PID lower limit	9999	0 to 100%, 9999	Refer to <b>Pr.132</b> .
1145 A643	Second PID deviation limit	9999	0 to 100%, 9999	Refer to <b>Pr.553</b> . (The Y205 signal is output.)
1146 A644	Second PID signal operation selection	0	0 to 3, 10 to 13	Refer to <b>Pr.554</b> .
1147 A661	Second output interruption detection time	1 s	0 to 3600 s, 9999	Refer to <b>Pr.575</b> .
1148 A662	Second output interruption detection level	0 Hz	0 to 590 Hz	Refer to <b>Pr.576</b> .
1149 A663	Second output interruption cancel level	1000%	900 to 1100%	Refer to <b>Pr.577</b> .

Set the second PID control.  
For how to enable the second PID control, refer to [page 613](#).

## ◆ Basic configuration of PID control

### ■ Pr.128 = "10, 11" (deviation value signal input)

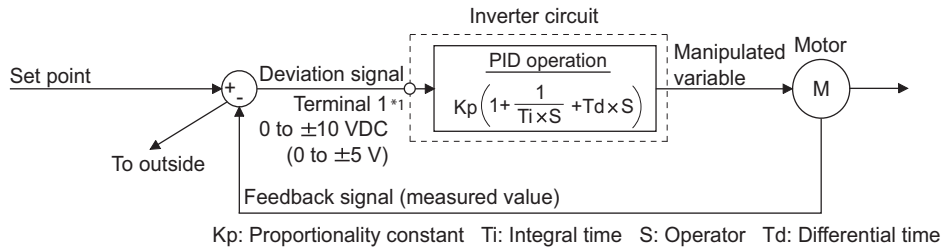

\*1 Set "0" to Pr.868 Terminal 1 function assignment. When Pr.868 ≠ "0", PID control is invalid.

### ■ Pr.128 = "20, 21" (measured value input)

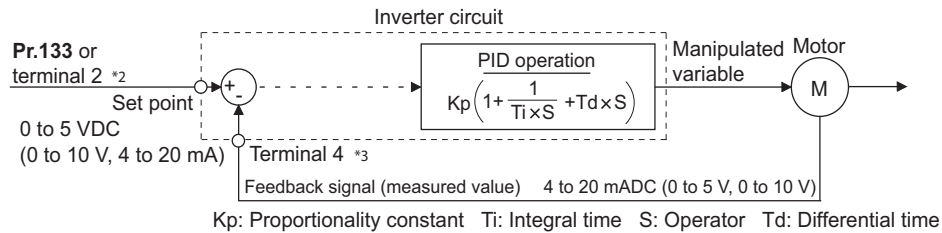

\*2 Note that the input of terminal 1 is added to the set point of terminal 2 as a set point.

\*3 Set "0" to Pr.858 Terminal 4 function assignment. When Pr.858 ≠ "0", PID control is invalid.

## ◆ PID action outline

### ■ PI action

PI action is a combination of proportional action (P) and integral action (I), and applies a manipulated amount according to the size of the deviation and transition or changes over time.

[Example of action when the measured value changes in a stepped manner]

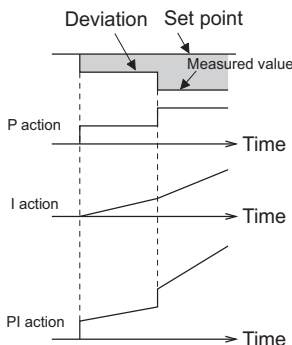

(Note) PI action is the result of P and I actions being added together.

### ■ PD action

PD action is a combination of proportional action (P) and differential action (D), and applies a manipulated amount according to the speed of the deviation to improve excessive characteristics.

[Example of action when the measured value changes proportionately]

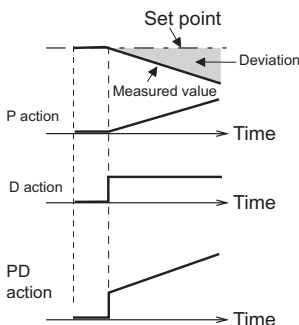

(Note) PD action is the result of P and D actions being added together.



**■ PID action**

PID action is a combination of PI and PD action, which enables control that incorporates the respective strengths of these actions.

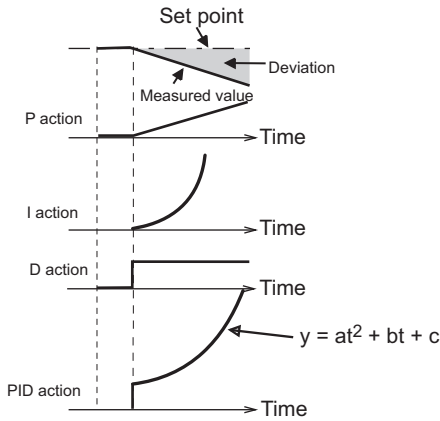

(Note) PID action is the result of all P, I and D actions being added together.

**■ Reverse action**

When deviation  $X = (\text{set point} - \text{measured value})$  is a plus value, the manipulated amount (output frequency) is increased, and when the deviation is a minus value, the manipulated amount is decreased.

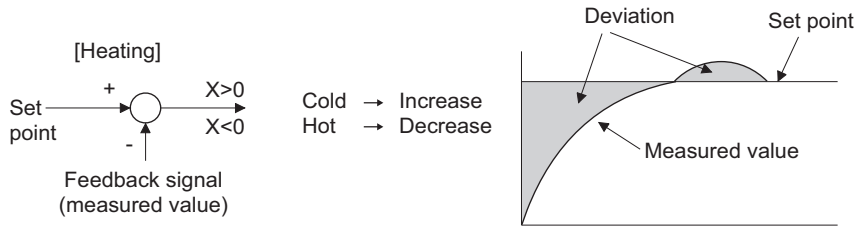

**■ Forward action**

When deviation  $X = (\text{set point} - \text{measured value})$  is a minus value, the manipulated amount (output frequency) is increased, and when the deviation is a plus value, the manipulated amount is decreased.

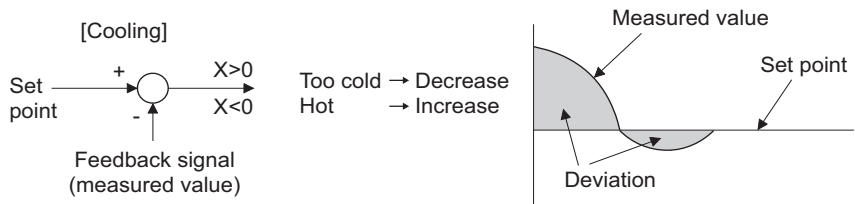

Relationship between deviation and manipulated amount (output frequency)

PID action setting	Deviation	
	Plus	Minus
Reverse action	↗	↘
Forward action	↘	↗



- Switch the power voltage/current specifications of terminals 2 and 4 by **Pr.73 Analog input selection** or **Pr.267 Terminal 4 input selection** to match the specification of the input device. After changing the **Pr.73** or **Pr.267** settings, check the voltage/current input selection switch. Incorrect setting may cause a fault, failure, or malfunction. (Refer to [page 496](#) for the setting.)

Pr.128 setting	Pr.609 Pr.610	PID action	Set point input	Measured value input	Deviation input
0	Invalid	PID invalid	—	—	—
10		Reverse action	—	—	Terminal 1
11		Forward action	—	—	
20		Reverse action	Terminal 2 or <b>Pr.133</b> <sup>*1</sup>	Terminal 4	—
21		Forward action			
40 to 43	Enabled	Dancer control	For details on dancer control, refer to <a href="#">page 622</a> .		
50	Invalid	Reverse action	—	—	Communication <sup>*2</sup>
51		Forward action	—	—	
60		Reverse action	Communication <sup>*2</sup>	Communication <sup>*2</sup>	—
61		Forward action			
70		Reverse action	—	—	PLC function (applied to the frequency) <sup>*3</sup>
71		Forward action	—	—	
80		Reverse action	PLC function (applied to the frequency) <sup>*3</sup>	PLC function (applied to the frequency) <sup>*3</sup>	—
81		Forward action			
90		Reverse action	—	—	PLC function (not applied to the frequency) <sup>*3</sup>
91		Forward action	—	—	
100	Reverse action	PLC function (not applied to the frequency) <sup>*3</sup>	PLC function (not applied to the frequency) <sup>*3</sup>	—	
101	Forward action				
1000	Enabled	Reverse action	According to <b>Pr.609</b> <sup>*1</sup>	According to <b>Pr.610</b>	—
1001		Forward action			
1010		Reverse action	—	—	According to <b>Pr.609</b>
1011		Forward action			
2000		Reverse action (without frequency reflected)	According to <b>Pr.609</b> <sup>*1</sup>	According to <b>Pr.610</b>	—
2001		Forward action (without frequency reflected)			
2010		Reverse action (without frequency reflected)	—	—	According to <b>Pr.609</b>
2011		Forward action (without frequency reflected)			

\*1 When **Pr.133** ≠ "9999", the **Pr.133** setting is valid.

\*2 CC-Link, CC-Link IE Field Network, or LONWORKS communication is available. For details on communication, refer to the Instruction Manual of each option.

\*3 For details on the PLC function, refer to the PLC Function Programming Manual.

- The set point/deviation input method can also be flexibly selected by **Pr.609 PID set point/deviation input selection** and the measured value input method can be selected by **Pr.610 PID measured value input selection**. Selection by **Pr.609** and **Pr.610** is valid when **Pr.128** = "1000 to 2011".

Pr.609 to Pr.610 settings	Input method
1	Terminal 1 <sup>*4</sup>
2	Terminal 2 <sup>*4</sup>
3	Terminal 4 <sup>*4</sup>
4	Communication <sup>*5</sup>
5	PLC function

\*4 When the same input method has been selected for the set point and measured value at **Pr.609** and **Pr.610**, set point input is invalid. (Inverter runs at set point 0%)

\*5 CC-Link, CC-Link IE Field Network, or LONWORKS communication is available. For details on communication, refer to the Instruction Manual of each option.

**NOTE**

- When terminals 2 and 4 are selected for deviation input, perform bias calibration using **C3** and **C6** to prevent a minus voltage from being entered as the deviation input signal. Input of a minus voltage might damage devices and the inverter.

- The following shows the relationship between the input values of the analog input terminals and set point, measured value and deviation. (Calibration parameter initial values)

Input terminal	Input specification*6	Relationship with analog input			Calibration parameter
		Set point	Result	Deviation	
Terminal 2	0 to 5 V	0 V = 0% 5 V = 100%	0 V = 0% 5 V = 100%	0 V = 0% 5 V = 100%	Pr.125, C2 to C4
	0 to 10 V	0 V = 0% 10 V = 100%	0 V = 0% 10 V = 100%	0 V = 0% 10 V = 100%	
	0 to 20 mA	0 mA = 0% 20 mA = 100%	0 mA = 0% 20 mA = 100%	0 mA = 0% 20 mA = 100%	
Terminal 1	0 to ±5 V	-5 to 0 V = 0% +5 V = +100%	-5 to 0 V = 0% +5 V = +100%	-5 V = -100% 0 V = 0% +5 V = +100%	When Pr.128 = "10", Pr.125 setting, C2 to C4. When Pr.128 ≥ "1000": C12 to C15.
	0 to ±10 V	-10 to 0 V = 0% +10 V = +100%	-10 to 0 V = 0% +10 V = +100%	-10 V = -100% 0 V = 0% +10 V = +100%	
Terminal 4	0 to 5 V	0 to 1 V = 0% 5 V = 100%	0 to 1 V = 0% 5 V = 100%	0 V = -20% 1 V = 0% 5 V = 100%	Pr.126, C5 to C7
	0 to 10 V	0 to 2 V = 0% 10 V = 100%	0 to 2 V = 0% 10 V = 100%	0 V = -20% 2 V = 0% 10 V = 100%	
	0 to 20 mA	0 to 4 mA = 0% 20 mA = 100%	0 to 4 mA = 0% 20 mA = 100%	0 mA = -20% 4 mA = 0% 20 mA = 100%	

\*6 Can be changed by Pr.73 Analog input selection, Pr.267 Terminal 4 input selection and the voltage/current input switch. (Refer to page 496.)

**NOTE**

- Always calibrate the input after changing the voltage/current input specification with **Pr.73** and **Pr.267**, and the voltage/current input selection switch.

## ◆ Input/output signals

- Assigning the PID control valid signal (X14) to the input terminal by **Pr.178 to Pr.189 (Input terminal function selection)** enables PID control to be performed only when the X14 signal is turned ON. When the X14 signal is OFF, regular inverter running is performed without PID action. (When the X14 signal is not assigned, PID control is enabled only by setting **Pr.128** ≠ "0".)
- Input signal

Signal	Function	Pr.178 to Pr.189 setting	Description
X14	PID control valid	14	When this signal is assigned to the input terminal, PID control is enabled when this signal is ON.
X80	Second PID control valid	80	
X64	PID forward/reverse action switchover	64	PID control is switched between forward and reverse action without changing parameters by turning ON this signal.
X79	Second PID forward/reverse action switchover	79	
X72	PID P control switchover	72	Integral and differential values can be reset by turning ON this signal.
X73	Second PID P control switchover	73	

- Output signal

Signal	Function	Pr.190 to Pr.196 setting		Description
		Positive logic	Negative logic	
FUP	PID upper limit	15	115	Output when the measured value signal exceeds <b>Pr.131 PID upper limit (Pr.1143 Second PID upper limit)</b> .
FUP2	Second PID upper limit	201	301	
FDN	PID lower limit	14	114	Output when the measured value signal falls below <b>Pr.132 PID lower limit (Pr.1144 Second PID lower limit)</b> .
FDN2	Second PID lower limit	200	300	
RL	PID forward/reverse rotation output	16	116	"Hi" is output when the output display of the parameter unit is forward rotation (FWD) and "Low" is output when the display is reverse rotation (REV) and stop (STOP).
RL2	Second PID forward/reverse rotation output	202	302	
PID	During PID control activated	47	147	Turns ON during PID control. When the PID calculation result is reflected to the output frequency ( <b>Pr.128 &lt; "2000"</b> ), the PID signal turns OFF at turn OFF of the start signal. When the PID calculation result is not reflected to the output frequency ( <b>Pr.128 ≥ "2000"</b> ), the PID signal turns ON during PID calculation regardless of the start signal status.
PID2	During second PID control activated	203	303	
Y48	PID deviation limit	48	148	Output when the absolute deviation value exceeds the limit value set in <b>Pr.553 PID deviation limit (Pr.1145 Second PID deviation limit)</b> .
Y205	Second PID deviation limit	205	305	
SLEEP	PID output interruption	70	170	Set <b>Pr.575 Output interruption detection time (Pr.1147 Second output interruption detection time) ≠ "9999"</b> . This signal turns ON when the PID output suspension function is activated.
SLEEP2	During second PID output shutoff	204	304	

#### NOTE

- Changing the terminal functions with **Pr.178 to Pr.189** and **Pr.190 to Pr.196** may affect other functions. Set parameters after confirming the function of each terminal.

### ◆ PID automatic switchover control (Pr.127)

- The system can be started up more quickly by starting up without PID control activated.
- When **Pr.127 PID control automatic switchover frequency** is set, the startup is made without PID control until the output frequency reaches the **Pr.127** setting. Once the PID control starts, the PID control is continued even if the output frequency drops to **Pr.127** setting or lower.

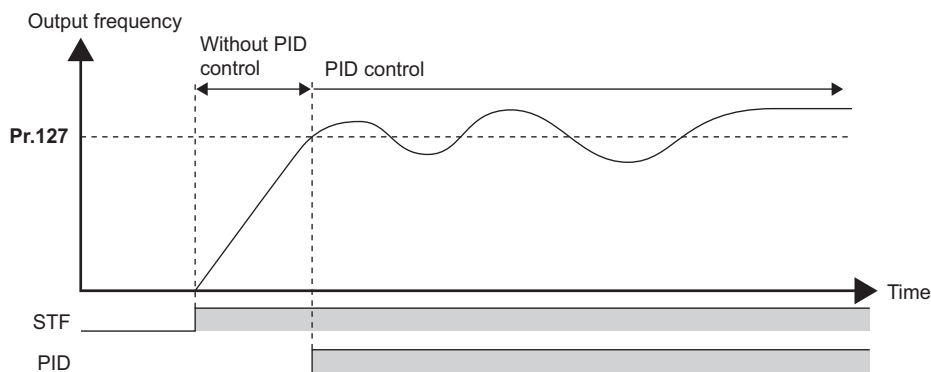

### ◆ Operation selection and sleep function stop selection when a value error is detected (FUP signal, FDN signal, Y48 signal, Pr.554)

- Using **Pr.554 PID signal operation selection**, set the action when the measured value input exceeds the upper limit (**Pr.131 PID upper limit**) or lower limit (**Pr.132 PID lower limit**), or when the deviation input exceeds the permissible value (**Pr.553 PID deviation limit**).
- Choose whether to output the signals (FUP, FDN, Y48) only or to activate the protective function to output the inverter shutoff.

- The stop action when the inverter output is shut off by the sleep function can be selected.

Pr.554 setting	Inverter operation		
	At FUP/FDN signal output <sup>*1</sup>	At Y48 signal output <sup>*1</sup>	At sleep operation start
0 (initial value)	Signal output only	Signal output only	Coasts to stop
1	Signal output + output shutoff (E.PID)		
2	Signal output only		
3	Signal output + output shutoff (E.PID)	Signal output + output shutoff (E.PID)	Deceleration stop
10	Signal output only	Signal output only	
11	Signal output + output shutoff (E.PID)		
12	Signal output only	Signal output + output shutoff (E.PID)	
13	Signal output + output shutoff (E.PID)		

\*1 When each of Pr.131, Pr.132 and Pr.553 settings corresponding to each of the FUP, FDN and Y48 signals is "9999" (no function), signal output and protective function are not available.

## ◆ PID output suspension function (sleep function) (SLEEP signal, Pr.575 to Pr.577)

5

- When a status where the output frequency after PID calculation is less than **Pr.576 Output interruption detection level** has continued for the time set in **Pr.575 Output interruption detection time** or longer, inverter running is suspended. This allows the amount of energy consumed in the inefficient low-speed range to be reduced.
- When the deviation (set point - measured value) reaches the PID output shutoff release level (**Pr.577** setting value -1000%) while the PID output suspension function is activated, the PID output suspension function is released, and PID control operation is automatically restarted.
- Whether to allow motor to coast to a stop or perform a deceleration stop when sleep operation is started can be selected using **Pr.554**.
- While the PID output suspension function is activated, the PID output interruption (SLEEP) signal is output. During this time, the Inverter running (RUN) signal turns OFF and the During PID control activated (PID) signal turns ON.
- For the terminal used for the SLEEP signal, set "70 (positive logic)" or "170 (negative logic)" in any of **Pr.190 to Pr.196 (Output terminal function selection)**.

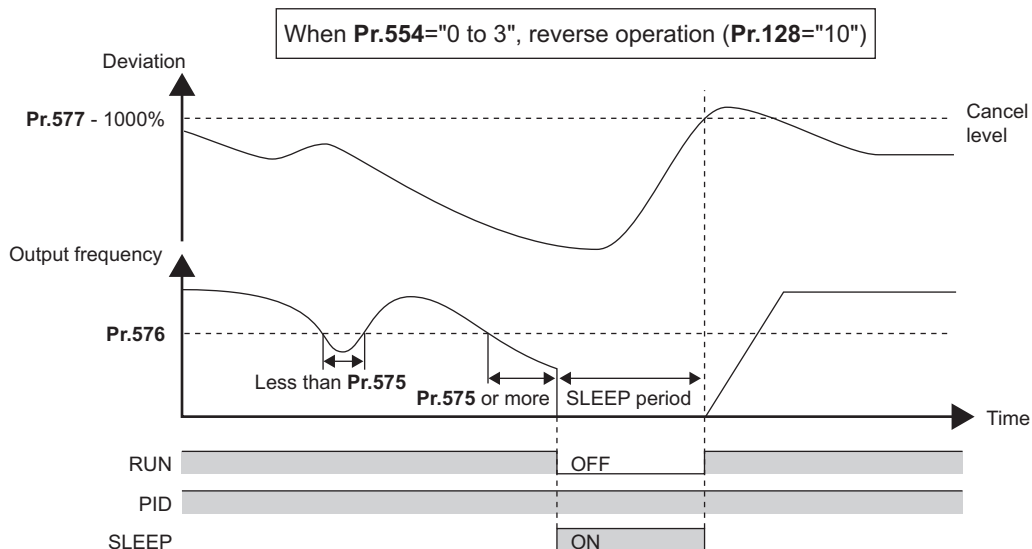

When Pr.554="10 to 13", reverse operation (Pr.128="10")

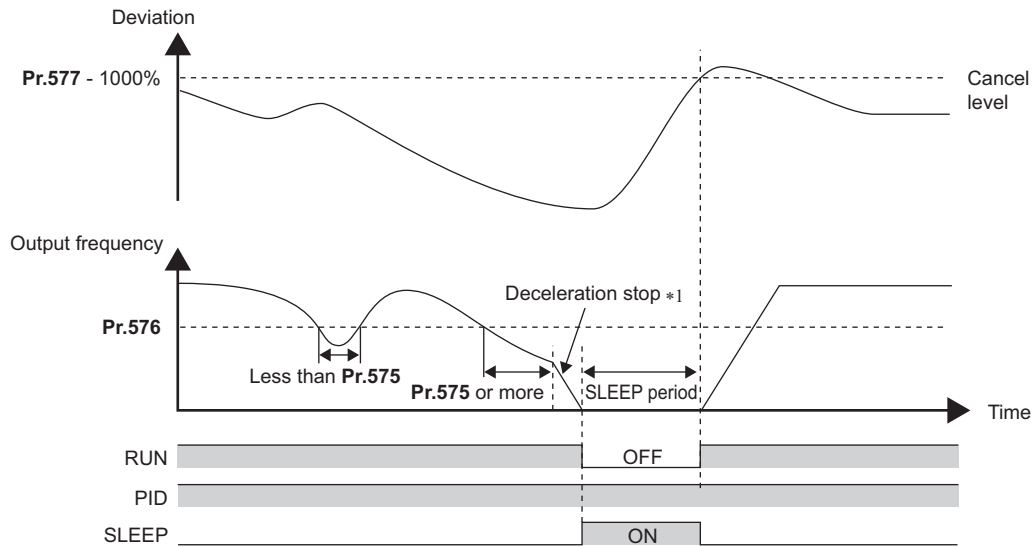

\*1 When the PID output shutoff release level is reached during a deceleration stop, output shutoff is released, operation is re-accelerated and PID control is continued. During deceleration, Pr.576 Output interruption detection level is invalid.

### ◆ Integral stop selection when the frequency is limited (Pr.1015)

- The operation for the integral term can be selected when the frequency or the manipulated amount is limited during PID control. The operation during output suspension can be selected for the integral term using the PID output suspension (sleep) function.
- The manipulation range can be selected.

Pr.1015 setting	Operation at limited frequency	Range of manipulation	Operation during output interruption
0 (initial value)	Integral stop	-100% to +100%	Integral clear
1	Integral continuation		
2	Integral stop	0 to 100%	Integral stop
10	Integral stop	-100% to +100%	
11	Integral continuation		
12	Integral stop	0 to 100%	

#### NOTE

- While the integral stop is selected, the integral stop is enabled when any of the following conditions is met.

Integral stop conditions
<ul style="list-style-type: none"> <li>• The frequency reaches the upper or lower limit.</li> <li>• The manipulated amount reaches plus or minus 100% (Pr.1015 = "0 or 10").</li> <li>• The manipulated amount reaches 0% or 100% (Pr.1015 = "2 or 12").</li> </ul>

### ◆ PID monitor function

- This function displays the PID control set point, measured value and deviation on the operation panel, and can output these from the terminals FM/CA and AM.
- An integral value indicating a negative % can be displayed on the deviation monitor. 0% is displayed as 1000. (These values cannot be output on the deviation monitor from terminals FM and CA.)

- Set the following values to **Pr.52 Operation panel main monitor selection, Pr.774 to Pr.776 (Operation panel monitor selection), Pr.992 Operation panel setting dial push monitor selection, Pr.54 FM/CA terminal function selection and Pr.158 AM terminal function selection** for each monitor.

Parameter Setting	Monitor description	Minimum increment	Monitor range			Remarks
			Terminal FM/CA	Terminal AM	Operation panel	
52	PID set point	0.1%	0 to 100% <sup>*1</sup>			"0" is displayed at all times when PID control is based in deviation input.
92	Second PID set point/deviation input selection					
53	PID measured value	0.1%	0 to 100% <sup>*1</sup>			
93	Second PID measured value					
67	PID measured value 2	0.1%	0 to 100% <sup>*1</sup>			Displays PID measured value even if the PID control operating conditions are not satisfied while the PID control is enabled. "0" is displayed at all times when PID control is based in deviation input.
95	Second PID measured value 2					
54	PID deviation	0.1%	Setting not available	-100% to 100% <sup>*1*2</sup>	900% to 1100% or -100% to 100% <sup>*1</sup>	Using <b>Pr.290 Monitor negative output selection</b> , negative values can be output to the terminal AM and displayed with a minus sign on the operation panel (FR-DU08). When signed indication is invalid, the indicated values are from "900%" to "1100%" on the operation panel. (0% is offset and displayed as "1000%.")
94	Second PID deviation					
91	PID manipulated amount	0.1%	Setting not available	-100% to 100% <sup>*2</sup>	900% to 1100% or -100% to 100%	
96	Second PID manipulated amount					

\*1 When **C42 (Pr.934)** and **C44 (Pr.935)** are set, the minimum increment changes from unit % to no unit, and the monitor range can be changed. (Refer to [page 615](#).)

\*2 When the minus value display is set disabled using **Pr.290**, the terminal AM output becomes "0".

## ◆ Adjustment procedure

1. Enable PID control  
When **Pr.128** ≠ "0", PID control is enabled.  
Set the set point, measured value and deviation input methods at **Pr.128, Pr.609 and Pr.610**.
2. Setting the parameter  
Adjust the PID control parameters of **Pr.127, Pr.129 to Pr.134, Pr.553, Pr.554, Pr.575 to Pr.577**.
3. Terminal setting  
Set the I/O terminals for PID control. (**Pr.178 to Pr.189 (Input terminal function selection), Pr.190 to Pr.196 (Output terminal function selection)**)
4. Turn the X14 signal ON  
When the X14 signal is assigned to the input terminal, PID control is enabled by the X14 signal turning ON.
5. Operation



## ◆ Calibration example

(Adjust room temperature to 25°C by PID control using a detector that outputs 4 mA at 0°C and 20 mA at 50°C.)

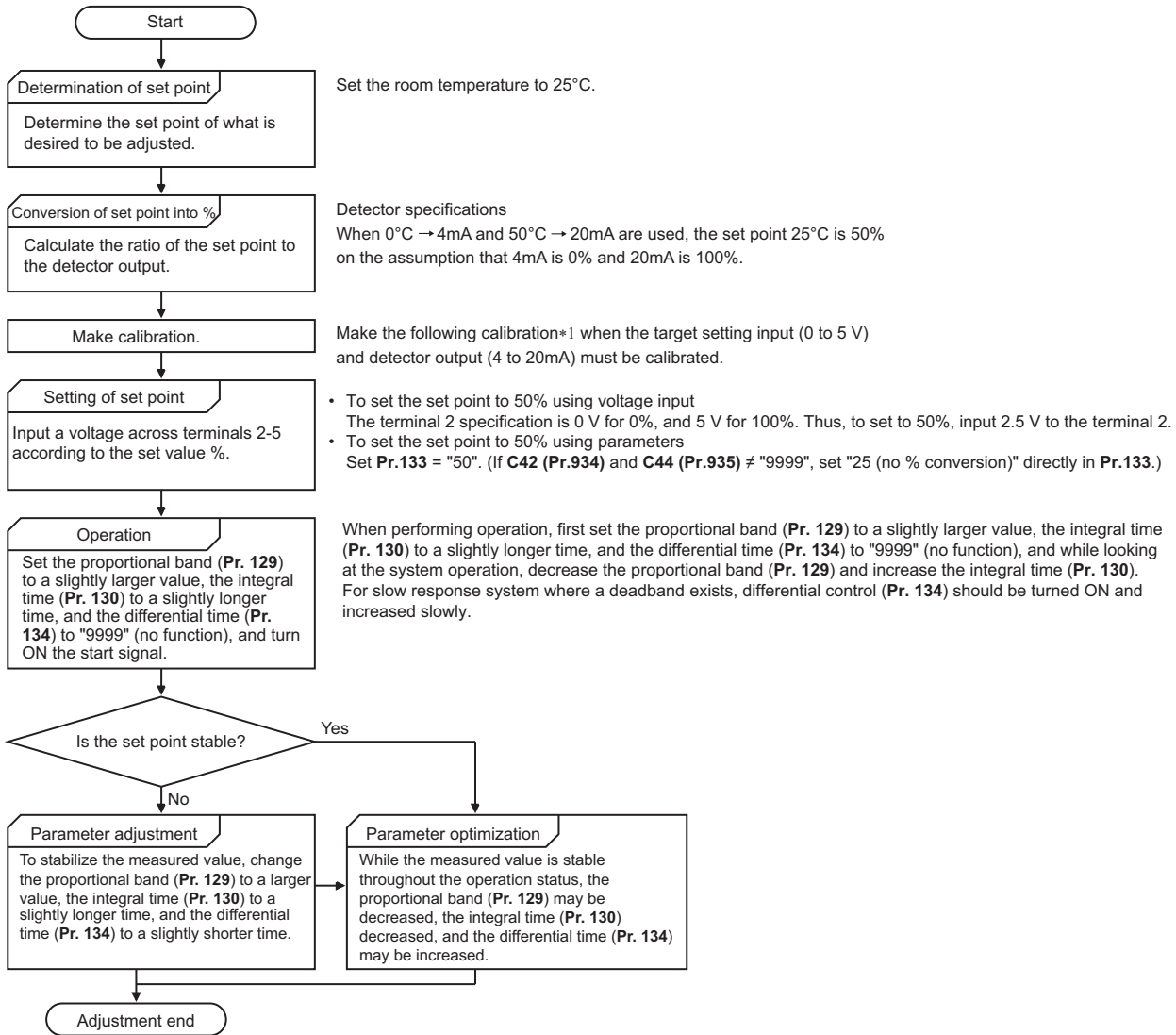

\*1 When calibration is required

Calibrate detector output and set point input by Pr.125, C2 (Pr.902) to C4 (Pr.903) (terminal 2) or Pr.126, C5 (Pr.904) to C7 (Pr.905) (terminal 4). (Refer to page 505.)

When both C42 (Pr.934) and C44 (Pr.935) are other than "9999", calibrate the detector output and set point input by Pr.934 and Pr.935 (terminal 4). (Refer to page 615.)

Make calibration in the PU operation mode during an inverter stop.

### • Calibrating set point input

(Example: To enter the set point on terminal 2)

1. 1. Apply the input (for example, 0 V) of set point setting 0% across terminals 2 and 5.
2. Using C2 (Pr.902), enter the frequency (for example, 0 Hz) to be output by the inverter when the deviation is 0%.
3. Using C3 (Pr.902), set the voltage value at 0%.
4. Apply the input (for example, 5 V) of set point setting 100% across terminals 2 and 5.
5. Using Pr.125, enter the frequency (for example, 60 Hz) to be output by the inverter when the deviation is 100%.
6. Using C4 (Pr.903), set the voltage value at 100%.

**NOTE**

- When the set point is set at **Pr.133**, the setting frequency of **C2 (Pr.902)** is equivalent to 0% and the setting frequency of **Pr.125 (Pr.903)** is equivalent to 100%.

Measured value input calibration

- Apply the input (for example, 4 mA) of measured value 0% across terminals 4 and 5.
- Perform calibration by **C6 (Pr.904)**.
- Apply the input (for example, 20 mA) of measured value 100% across terminals 4 and 5.
- Perform calibration by **C7 (Pr.905)**.

**NOTE**

- Set the frequencies set at **C5 (Pr.904)** and **Pr.126** to each of the same values set at **C2 (Pr.902)** and **Pr.125**.
- The display unit for analog input can be changed from "%" to "V" or "mA". (Refer to [page 507](#).)

- The following figure shows the results of having performed the calibration above.

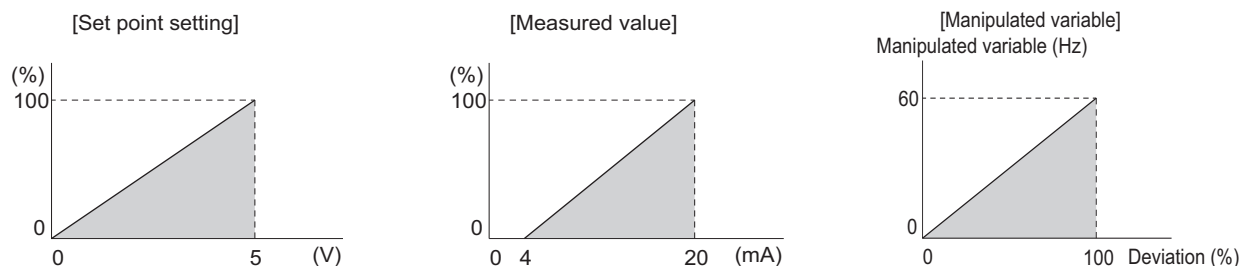

### ◆ Setting multiple PID functions

- When the second PID function is set, two sets of PID functions can be switched for use. The PID setting is selected as shown in the following table.

Pr.128 setting (first PID setting)	Pr.753 setting (second PID setting)	Pr.155 setting *1	RT signal	PID setting applied to the output frequency
"0" or not applied to the frequency	"0" or not applied to the frequency	—	—	Control other than PID control
"0" or not applied to the frequency	Applied to the frequency	—	—	Second PID setting
Applied to the frequency	"0" or not applied to the frequency	—	—	First PID setting
Applied to the frequency	Applied to the frequency	0	OFF	First PID setting
			ON	Second PID setting
		10	—	First PID setting
Dancer control	Not applied to the frequency *2	—	—	Dancer control

\*1 While **Pr.155** = "0", the second function is enabled immediately after the RT signal turns ON. While **Pr.155** = "10", the second function is enabled only during constant speed operation when the RT signal turns ON. (For the details, refer to [page 525](#).)

\*2 When dancer control is selected, the setting is not applied to the frequency.

- The parameters and signals for the second PID function are in the same way as the following parameters and signals of the first PID function. Refer to the first PID function when setting the second PID functions.

Classification	First PID function parameters		Second PID function parameters	
	Pr.	Name	Pr.	Name
Parameter	127	PID control automatic switchover frequency	754	Second PID control automatic switchover frequency
	128	PID action selection	753	Second PID action selection
	129	PID proportional band	756	Second PID proportional band
	130	PID integral time	757	Second PID integral time
	131	PID upper limit	1143	Second PID upper limit
	132	PID lower limit	1144	Second PID lower limit
	133	PID action set point	755	Second PID action set point
	134	PID differential time	758	Second PID differential time
	553	PID deviation limit	1145	Second PID deviation limit
	554	PID signal operation selection	1146	Second PID signal operation selection
	575	Output interruption detection time	1147	Second output interruption detection time
	576	Output interruption detection level	1148	Second output interruption detection level
	577	Output interruption cancel level	1149	Second output interruption cancel level
	609	PID set point/deviation input selection	1140	Second PID set point/deviation input selection
610	PID measured value input selection	1141	Second PID measured value input selection	

Classification	First PID function parameters		Second PID function parameters	
	Signal	Name	Signal	Name
Input signal	X14	PID control valid	X80	Second PID control valid
	X64	PID forward/reverse action switchover	X79	Second PID forward/reverse action switchover
	X72	PID P control switchover	X73	Second PID P control switchover
Output signal	FUP	PID upper limit	FUP2	Second PID upper limit
	FDN	PID lower limit	FDN2	Second PID lower limit
	RL	PID forward/reverse rotation output	RL2	Second PID forward/reverse rotation output
	PID	During PID control activated	PID2	During second PID control activated
	SLEEP	PID output interruption	SLEEP2	During second PID output shutoff
	Y48	PID deviation limit	Y205	Second PID deviation limit

- Even if the X14 signal is ON, PID control is stopped and multi-speed or JOG operation is performed when the multi-speed operation (RH, RM, RL, or REX) signal or JOG signal (JOG operation) is input.
- PID control is invalid under the following settings.
  - Pr.79 Operation mode selection = "6"** (Switchover mode)
- Note that input to the terminal 1 is added to the terminals 2 and 4 inputs. For example when **Pr.128 = "20 or 21"**, the terminal 1 input is considered as a set point and added to the set point of the terminal 2.
- To use terminal 4 and 1 inputs in PID control, set "0" (initial value) to **Pr.858 Terminal 4 function assignment** and **Pr.868 Terminal 1 function assignment**. When a value other than "0", PID control is invalid.
- Changing the terminal functions with **Pr.178 to Pr.189** and **Pr.190 to Pr.196** may affect other functions. Set parameters after confirming the function of each terminal.
- When PID control is selected, the minimum frequency becomes the frequency of **Pr.902** and the maximum frequency becomes the frequency of **Pr.903**.  
(The **Pr.1 Maximum frequency** and **Pr.2 Minimum frequency** settings also are valid.)
- During PID operation, the remote operation function is invalid.
- When control is switched to PID control during normal operation, the frequency during that operation is not carried over, and the value resulting from PID calculation referenced to 0 Hz becomes the command frequency.

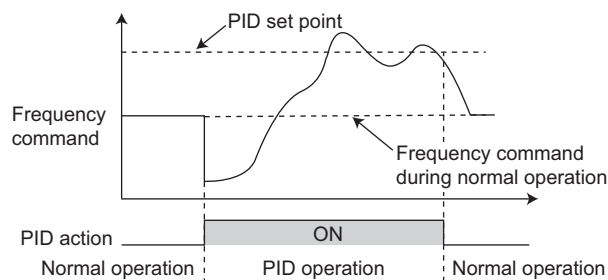

Operation when control is switched to PID control during normal operation

#### Parameters referred to

- Pr.59 Remote function selection** [page 377](#)
- Pr.73 Analog input selection** [page 496](#)
- Pr.79 Operation mode selection** [page 389](#)
- Pr.178 to Pr.189 (Input terminal function selection)** [page 521](#)
- Pr.190 to Pr.196 (Output terminal function selection)** [page 473](#)
- Pr.290 Monitor negative output selection** [page 457](#)
- C2 (Pr.902) to C7 (Pr.905) Frequency setting voltage (current) bias/gain** [page 505](#)

## 5.14.11 Changing the display increment of numerical values used in PID control

When the LCD operation panel (FR-LU08) or the parameter unit (FR-PU07) is used, the display unit of parameters and monitor items related to PID control can be changed to various units.

Pr.	Name	Initial value	Setting range	Description
759 A600	PID unit selection	0	0 to 43	Change the unit of the PID control-related values that is displayed on the LCD operation panel (FR-LU08) or the parameter unit (FR-PU07).
			9999	Without display unit switching
C42 (934) A630 <sup>*1</sup>	PID display bias coefficient	9999	0 to 500	Set the coefficient of the bias side (minimum) of measured value input.
			9999	Displayed in %.
C43 (934) A631 <sup>*1</sup>	PID display bias analog value	20%	0 to 300%	Set the converted % of the bias side (minimum) current/voltage of measured value input.
C44 (935) A632 <sup>*1</sup>	PID display gain coefficient	9999	0 to 500	Set the coefficient of the gain side (maximum) of measured value input.
			9999	Displayed in %.
C45 (935) A633 <sup>*1</sup>	PID display gain analog value	100%	0 to 300%	Set the converted % of the gain side (maximum) current/voltage of measured value input.
1136 A670	Second PID display bias coefficient	9999	0 to 500 9999	Second PID control
1137 A671	Second PID display bias analog value	20%	0 to 300%	
1138 A672	Second PID display gain coefficient	9999	0 to 500 9999	
1139 A673	Second PID display gain analog value	100%	0 to 300%	
1142 A640	Second PID unit selection	9999	0 to 43, 9999	

\*1 The parameter number in parentheses is the one for use with the LCD operation panel and the parameter unit.

## ◆ Calibration of PID display bias and gain (C42 (Pr.934) to C45 (Pr.935))

- When both **C42 (Pr.934)** and **C44 (Pr.935)** ≠ "9999", the bias and gain values for the set point, measured value and deviation in PID control can be calibrated.
- "Bias"/"gain" function can adjust the relation between PID displayed coefficient and measured value input signal that is externally input. Examples of these measured value input signals are 0 to 5 VDC, 0 to 10 VDC, or 4 to 20 mA DC. (The terminals used for measured value input can be selected at **Pr.128**, **Pr.609**, **Pr.610**.)
- Set the value that is displayed when the PID measured value (control amount) is 0% to **C42 (Pr.934)** and the value that is displayed when the PID measured value (control amount) is 100% to **C44 (Pr.935)**.
- When both of **C42 (Pr.934)** and **C44 (Pr.935)** ≠ "9999" and **Pr.133** is set as the set point, the setting of **C42 (Pr.934)** is treated as 0%, and **C44 (Pr.935)** as 100%.

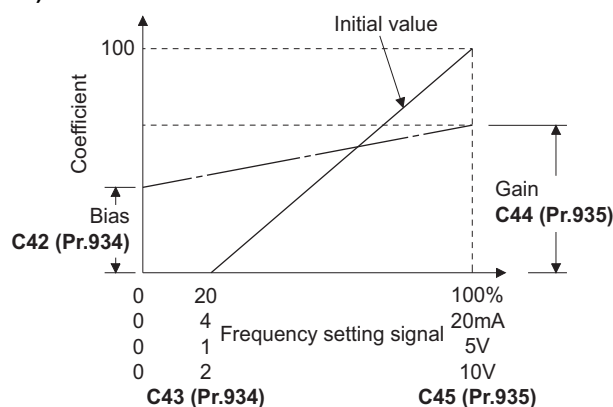

- There are three methods to adjust the PID display bias/gain.
  - Method to adjust any point by application of a current (voltage) to the measured value input terminal
  - Method to adjust any point without application of a current (voltage) to the measured value input terminal
  - Method to adjust only the display coefficient without adjustment of current (voltage)

(Refer to [page 505](#) for details, and make the necessary adjustments by considering **C7 (Pr.905)** as **C45 (Pr.935)** and **Pr.126** as **C44 (Pr.935)**.)

**NOTE**

- Always calibrate the input after changing the voltage/current input specification with **Pr.73 and Pr.267**, and the voltage/current input selection switch.

- Take caution when the following condition is satisfied because the inverter recognizes the deviation value as a negative (positive) value even though a positive (negative) deviation is given: **Pr.934** (PID bias coefficient) > **Pr.935** (PID gain coefficient).

To perform a reverse action, set **Pr.128 PID action selection** to forward action. Alternatively, to perform a forward action, set **Pr.128** to reverse action. In this case, the PID output shutoff release level is (1000 - **Pr.577**).

Pr.934 < Pr.935 (normal setting)		Pr.934 ≥ Pr.935	
Reverse action	Reverse action setting to <b>Pr.128</b>	Reverse action	Forward action setting to <b>Pr.128</b>
Forward action	Forward action setting to <b>Pr.128</b>	Forward action	Reverse action setting to <b>Pr.128</b>
PID output shutoff release level	<b>Pr.577</b> - 1000	PID output shutoff release level	1000 - <b>Pr.577</b>

(Example) Set the following: **Pr.934** = "500" or 20% (4 mA is applied), **Pr.935** = "100" or 100% (20 mA is applied).

When the set point = 400 and the measured value = 360, the deviation is +40 (>0), but the inverter recognizes the deviation as -10% (<0). Because of this, operation amount does not increase in the reverse operation setting.

The operation amount increases when the forward operation is set.

To perform PID output shutoff release at deviation of +40 or higher, set **Pr.577** = "960".

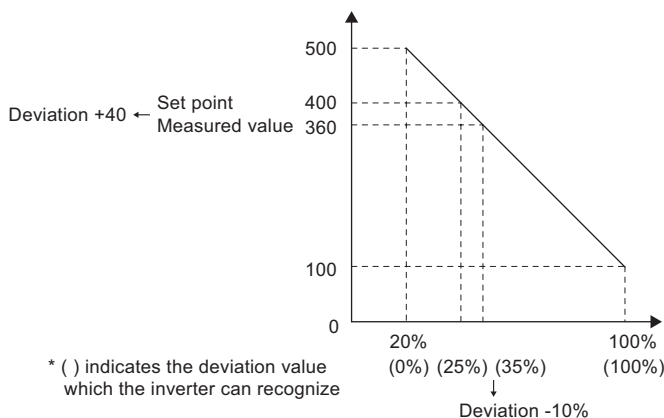

- The display of the following parameters is changed according to the **C42 (Pr.934)**, **C44 (Pr.935)**, **Pr.1136**, and **Pr.1138** settings.

Pr.	Name
131	PID upper limit
132	PID lower limit
133	PID action set point
553	PID deviation limit
577	Output interruption cancel level
761	Pre-charge ending level
763	Pre-charge upper detection level

Pr.	Name
1143	Second PID upper limit
1144	Second PID lower limit
755	Second PID action set point
1145	Second PID deviation limit
1149	Second output interruption cancel level
766	Second pre-charge ending level
768	Second pre-charge upper detection level

**◆ Changing the PID display coefficient of the LCD operation panel (FR-LU08) or the parameter unit (FR-PU07) (Pr.759)**

- Use **Pr.759 PID unit selection** to change the unit of the displayed value on the FR-LU08 or the FR-PU07. For the coefficient set in **C42 (Pr.934)** to **C44 (Pr.935)**, the units can be changed as follows.

Pr.759 setting	Unit indication	Unit name
9999	%	%
0	—	(No indication)
1	K	Kelvin
2	C	Degree Celsius
3	F	Degree Fahrenheit
4	PSI	Pound-force per Square Inch
5	MPa	Mega Pascal
6	kPa	Kilo Pascal
7	Pa	Pascal
8	bar	Bar
9	mbr	Millibar
10	GPH	Gallon per Hour
11	GPM	Gallon per Minute
12	GPS	Gallon per Second
13	L/H	Liter per Hour
14	L/M	Liter per Minute
15	L/S	Liter per Second
16	CFH	Cubic Feet per Hour
17	CFM	Cubic Feet per Minute
18	CFS	Cubic Feet per Second
19	CMH	Cubic Meter per Hour
20	CMM	Cubic Meter per Minute

Pr.759 setting	Unit indication	Unit name
21	CMS	Cubic Meter per Second
22	ftM	Feet per Minute
23	ftS	Feet per Second
24	m/M	Meter per Minute
25	m/S	Meter per Second
26	lbH	Pound per Hour
27	lbM	Pound per Minute
28	lbS	Pound per Second
29	iWC	Inch Water Column
30	iWG	Inch Water Gauge
31	fWG	Feet of Water Gauge
32	mWG	Meter of Water Gauge
33	iHg	Inches of Mercury
34	mHg	Millimeters of Mercury
35	kgH	Kilogram per Hour
36	kgM	Kilogram per Minute
37	kgS	Kilogram per Second
38	ppm	Pulse per Minute
39	pps	Pulse per Second
40	kW	Kilowatt
41	hp	Horse Power
42	Hz	Hertz
43	rpm	Revolution per Minute

## 5.14.12 PID Pre-charge function

This function drives the motor at a certain speed before starting PID control. This function is useful for a pump with a long hose, since PID control would start before the pump is filled with water, and proper control would not be performed without this function,

Pr.	Name	Initial value	Setting range	Description
<b>760</b> <b>A616</b>	<b>Pre-charge fault selection</b>	0	0	Fault indication with output shutoff immediately after pre-charge fault occurs.
			1	Fault indication with deceleration stop after pre-charge fault occurs.
<b>761</b> <b>A617</b>	<b>Pre-charge ending level</b>	9999	0 to 100%	Set the measured amount to end the pre-charge operation.
			9999	Without pre-charge ending level
<b>762</b> <b>A618</b>	<b>Pre-charge ending time</b>	9999	0 to 3600 s	Set the time to end the pre-charge operation.
			9999	Without pre-charge ending time
<b>763</b> <b>A619</b>	<b>Pre-charge upper detection level</b>	9999	0 to 100%	Set the upper limit for the pre-charged amount. A pre-charge fault occurs when the measured value exceeds the setting during pre-charging.
			9999	Without Pre-charge upper detection level
<b>764</b> <b>A620</b>	<b>Pre-charge time limit</b>	9999	0 to 3600 s	Set the time limit for the pre-charged amount. A pre-charge fault occurs when the pre-charge time exceeds the setting.
			9999	Without Pre-charge time limit
<b>765</b> <b>A656</b>	<b>Second pre-charge fault selection</b>	0	0, 1	Refer to <b>Pr.760</b> .
<b>766</b> <b>A657</b>	<b>Second pre-charge ending level</b>	9999	0 to 100%, 9999	Refer to <b>Pr.761</b> .
<b>767</b> <b>A658</b>	<b>Second pre-charge ending time</b>	9999	0 to 3600 s, 9999	Refer to <b>Pr.762</b> .
<b>768</b> <b>A659</b>	<b>Second pre-charge upper detection level</b>	9999	0 to 100%, 9999	Refer to <b>Pr.763</b> .
<b>769</b> <b>A660</b>	<b>Second pre-charge time limit</b>	9999	0 to 3600 s, 9999	Refer to <b>Pr.764</b> .

## ◆ Operation selection for the pre-charge function

- To enable the pre-charge function when PID control is enabled, set the pre-charge end conditions at **Pr.761 Pre-charge ending level** and at **Pr.762 Pre-charge ending time**, or set "77" to **Pr.178 to Pr.189 (Input terminal function selection)**. When operation is started, the inverter runs at the frequency set to **Pr.127 PID control automatic switchover frequency** to enter the pre-charge state.
- Pre-charge ends and PID control starts after a pre-charge ending condition is satisfied.
- The pre-charge function is also activated at a start after release of a PID output suspension (sleep) state or MRS (output shutoff). The PID output suspension (sleep) function is not activated until the started pre-charge operation ends.
- During pre-charge operation, the During pre-charge operation (Y49) signal is output. For the terminal used for the Y49 signal output, set "49 (positive logic)" or "149 (negative logic)" in any of **Pr.190 to Pr.196 (Output terminal function selection)** to assign the function.
- The pre-charge function valid/invalid settings and pre-charge ending conditions are as follows:

Pr.127 setting	Pre-charge ending condition setting			Pre-charge function	Valid pre-charge ending condition <sup>*1</sup>		
	Pr.761 setting	Pr.762 setting	X77 signal				
9999	—	—	—	Disabled	—		
Other than 9999	9999	9999	Not assigned	Enabled	—	—	X77
			Assigned		—	Time	—
		Other than 9999	Not assigned		—	Time	X77
			Assigned		Result	—	—
	Other than 9999	9999	Not assigned		Result	—	X77
			Assigned		Result	Time	—
		Other than 9999	Not assigned		Result	Time	—
			Assigned		Result	Time	X77

\*1 When two or more ends conditions are satisfied, the pre-charge operation ends by the first-satisfied condition.

### NOTE

- During the pre-charge operation, it is regarded as integrated value = estimated value. The motor speed may drop shortly from the automatic switchover frequency depending on the parameter settings.
- Parameter changes and switchover to the second PID control are applied immediately. If PID control has not started when the settings were changed, PID control starts with changed settings. (If PID control has already started, these settings do not apply. If the changed settings already satisfies a condition to start PID control, the PID control starts as soon as these are changed.)
- The pre-charge also ends when PID control is set to invalid, the start command has been turned OFF, and output has been shut off.

## ◆ Example of the pre-charge operation

- When the measured amount reaches the pre-charge ending level (**Pr.761 Pre-charge ending level** ≠ "9999") The pre-charge operation ends when the measured value reaches the **Pr.761** setting or higher, then the PID control is performed.

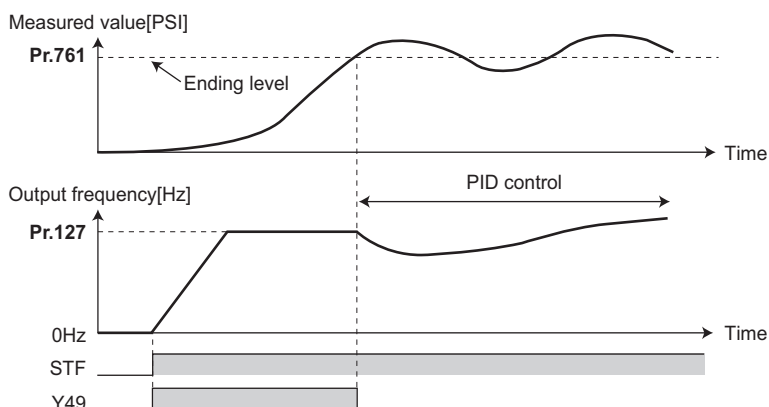



- When the elapsed time reaches the pre-charge ending time (**Pr.762 Pre-charge ending time** ≠ "9999")  
The pre-charge operation ends when the pre-charge time reaches the **Pr.762** setting or higher, then the PID control is performed.

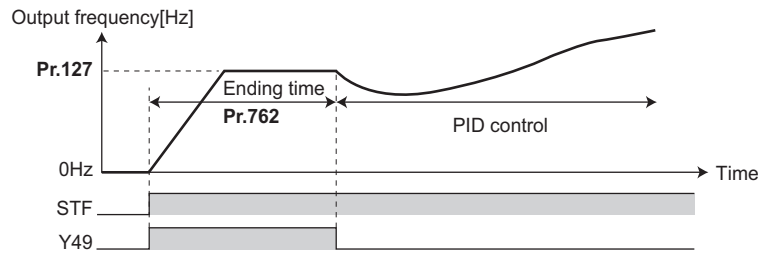

- When the signal is input to end the pre-charge operation  
When the X77 signal turns ON, the pre-charge operation ends, and the PID control starts. (If a start command is given while the X77 signal is ON, the pre-charge operation is not performed, and PID control starts.)

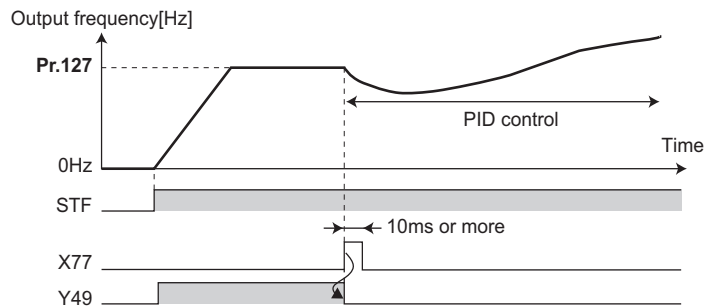

**NOTE**

- When the PID output suspension (sleep) function is in use, and the X77 signal is set to valid after this function is released, set the X77 signal to OFF after checking that the During pre-charge operation (Y49) signal is OFF.
- When the PID output suspension (sleep) function is in use, and PID control is to be performed immediately after this function is released, leave the X77 signal ON until PID control ends.
- When the pre-charge operation is valid, the pre-charge operation is performed at the output shutoff cancellation (MRS signal, etc.). (The pre-charge operation is also performed in the case of instantaneous power failure when the automatic restart after instantaneous power failure is valid.)
- When the control method is changed to PID control from a control with higher priority in frequency command (multi-speed setting, JOG operation, etc.), the motor is accelerated/decelerated until its speed reaches the automatic switchover frequency (**Pr.127**), and the pre-charge is performed.

**◆ Operation setting at pre-charge fault**

- The protective function can be activated when limit values are exceeded if the time limit is set at **Pr.764 Pre-charge time limit** and the measured value limit level is set at **Pr.763 Pre-charge upper detection level**.
- Whether to shut off output immediately after the protective function is activated or after a deceleration stop can be selected by **Pr.760 Pre-charge fault selection**. (Pre-charge protective function is effective regardless of the setting of pre-charge ending conditions.)
- When the time limit is exceeded, the Pre-charge time over (Y51) signal is output. When the measured value limit level is exceeded, the Pre-charge level over (Y53) signal is output. For the Y51 signal, set "51 (positive logic)" or "151 (negative logic)" to **Pr.190 to Pr.196 (Output terminal function selection)**, and for the Y53 signal, set "53 (positive logic)" or "153 (negative logic)" in **Pr.190 to Pr.196 (Output terminal function selection)** to assign the functions to terminals.

**NOTE**

- For **Pr.764 Pre-charge time limit**, set a value greater than **Pr.762 Pre-charge ending time**.
- For **Pr.763 Pre-charge upper detection level**, set a value greater than **Pr.761 Pre-charge ending level**.

- Example of protective function by time limit (Pr.760 = "0")

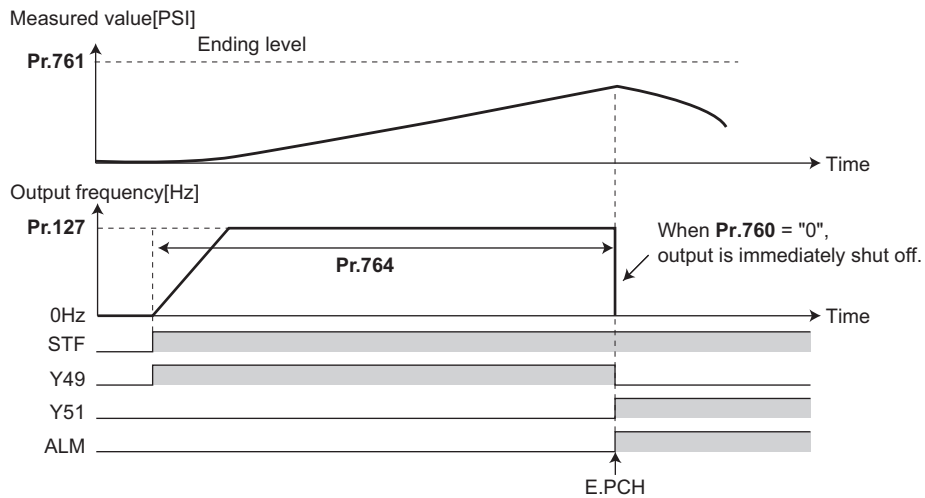

- Example of protective function measured value limit (Pr.760 = "1")

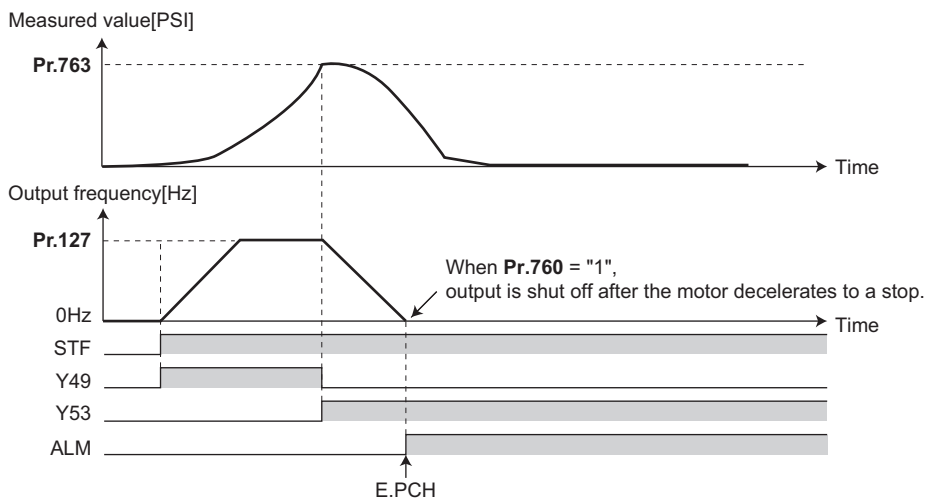

## ◆ Setting multiple PID pre-charge functions

- When the second pre-charge function is set, two sets of pre-charge functions can be switched for use. The second pre-charge function is enabled by the turning ON RT signal.
- The second pre-charge function parameters and signals function in the same way as the following parameters and signals of the first pre-charge function. Refer to the first pre-charge function when setting the second pre-charge functions.

Classification	First pre-charge function parameters		Second pre-charge function parameters	
	Pr.	Name	Pr.	Name
Parameter	760	Pre-charge fault selection	765	Second pre-charge fault selection
	761	Pre-charge ending level	766	Second pre-charge ending level
	762	Pre-charge ending time	767	Second pre-charge ending time
	763	Pre-charge upper detection level	768	Second pre-charge upper detection level
	764	Pre-charge time limit	769	Second pre-charge time limit

Classification	First pre-charge function parameters		Second pre-charge function parameters	
	Signal	Name	Signal	Name
Input signal	X77	Pre-charge end command	X78	Second pre-charge end command
Output signal	Y49	During pre-charge operation	Y50	During second pre-charge operation
	Y51	Pre-charge time over	Y52	Second pre-charge time over
	Y53	Pre-charge level over	Y54	Second pre-charge level over

**NOTE**

- The second PID pre-charge function is valid also when the first pre-charge function is set to invalid and the second pre-charge function is set.
- When "10" (second function enabled only during constant-speed operation) is set to **Pr.155**, the second PID function is not selected even if the RT signal turns ON.

## 5.14.13 Dancer control

PID control is performed using detected dancer roll position as feedback data. The dancer roll is controlled to be at a designated position.

Pr.	Name	Initial value	Setting range	Description		
44 F020	Second acceleration/ deceleration time	5 s	0 to 3600 s	Set the acceleration/deceleration time during dancer control. In dancer control, this parameter becomes the acceleration/deceleration time of the main speed. This setting does not operate as the second acceleration/deceleration time.		
45 F021	Second deceleration time	9999	0 to 3600 s	Set the deceleration time during dancer control. In dancer control, this parameter becomes the deceleration time of the main speed. This setting does not operate as the second deceleration time.		
			9999	<b>Pr.44</b> is the deceleration time.		
128 A610	PID action selection	0	0	No PID action		
			40	PID reverse action	Additive method: Fixed	For dancer control
			41	PID forward action	Additive method: Fixed	
			42	PID reverse action	Additive method: Ratio	
			43	PID forward action	Additive method: Ratio	
Others	Refer to <a href="#">page 601</a> .					
129 A613	PID proportional band	100%	0.1 to 1000%	If a narrow proportional band is set (small parameter setting value), the manipulated amount changes considerably by slight changes in the measured value. As a result, response improves as the proportional band becomes narrower, though stability worsens as shown by the occurrence of hunting. Gain $K_p=1/\text{proportional band}$		
			9999	No proportional control		
130 A614	PID integral time	1 s	0.1 to 3600 s	With deviation step input, this is the time (Ti) used for obtaining the same manipulated amount as proportional band (P) by only integral (I) action. Arrival to the set point becomes quicker the shorter an integral time is set, though hunting is more likely to occur.		
			9999	No integral control		
131 A601	PID upper limit	9999	0 to 100%	Set the upper limit. The FUP signal is output when the feedback value exceeds this setting. The maximum input (20 mA/5 V/10 V) of the measured value (terminal 4) is equivalent to 100%.		
			9999	No function		
132 A602	PID lower limit	9999	0 to 100%	Set the lower limit. The FDN signal is output when the measured value (terminal 4) falls below the setting range. The maximum input (20 mA/5 V/10 V) of the measured value is equivalent to 100%.		
			9999	No function		
133 A611	PID action set point	9999	0 to 100%	Set the set point during PID control.		
			9999	Input of set point by terminal selected by <b>Pr.609</b>		
134 A615	PID differential time	9999	0.01 to 10 s	With deviation ramp input, this is the time (Td) used for obtaining the manipulated amount only by proportional action (P). Response to changes in deviation increase greatly as the differential time increases.		
			9999	No differential control		
609 A624	PID set point/deviation input selection	2	1	The set point is input through terminal 1.		
			2	The set point is input through terminal 2.		
			3	The set point is input through terminal 4.		
			4	The set point is input via communication		
			5	The set point is input by the PLC function.		

Pr.	Name	Initial value	Setting range	Description
610 A625	PID measured value input selection	3	1	The measured value is input through terminal 1.
			2	The measured value is input through terminal 2.
			3	The measured value is input through terminal 4.
			4	The measured value is input via communication.
			5	The measured value is input by the PLC function.
1134 A605	PID upper limit manipulated value	100%	0 to 100%	Set the upper limit of PID action.
1135 A606	PID lower limit manipulated value	100%	0 to 100%	Set the lower limit of PID action.

## ◆ Block diagram of dancer control

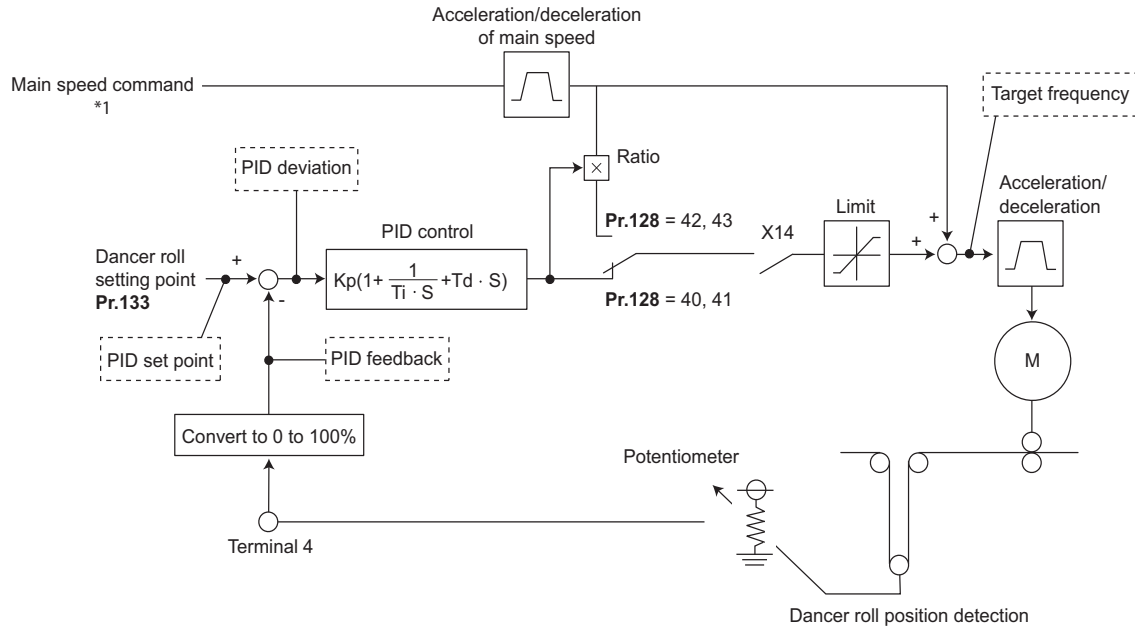

\*1 The main speed can be selected in all operation modes, External (analog voltage input, multi-speed), PU (digital frequency setting) and Communication (RS-485).

## ◆ Outline of dancer control

- Dancer control is performed by setting "40 to 43" in **Pr.128 PID action selection**. The main speed command is the speed command for each operation mode (External, PU, and communication). PID control is performed by the dancer roll position detection signal, and the control result is added to the main speed command. For the main speed acceleration/deceleration time, set the acceleration time to **Pr.44 Second acceleration/deceleration time** and the deceleration time to **Pr.45 Second deceleration time**.

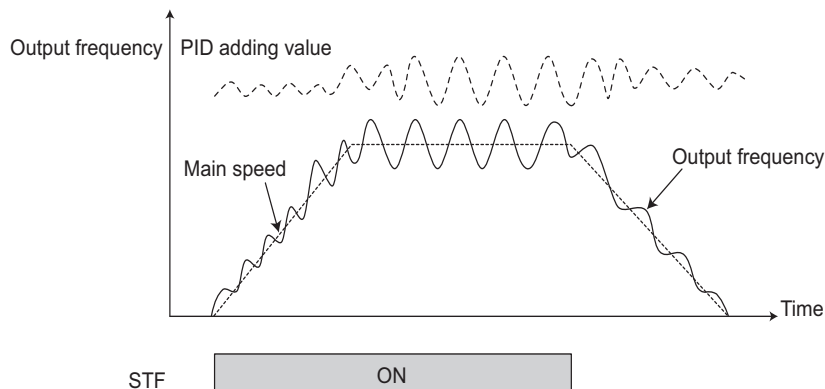

**NOTE**

- Normally, set **Pr.7 Acceleration time** and **Pr.8 Deceleration time** to 0 s. When the **Pr.7 and Pr.8** settings are large, dancer control response becomes slow during acceleration/deceleration.
- The **Pr.127 PID control automatic switchover frequency** setting is enabled. The larger setting value between **Pr.7** and **Pr.44** is used as the acceleration time during normal operation. For the deceleration time, the larger setting value between **Pr.8** and **Pr.45** is used. (For details on **Pr.127**, refer to [page 601](#).)
- If an automatic restart after instantaneous power failure is activated during dancer control, E.OC[] or E.OV[] is likely to occur. In such case, disable the automatic restart after instantaneous power failure function (**Pr.57 = "9999"**).

**◆ Connection diagram**

- Sink logic
- **Pr.128 = 41**
- **Pr.182 = 14**
- **Pr.193 = 14**
- **Pr.194 = 15**
- **Pr.133 = Set point**

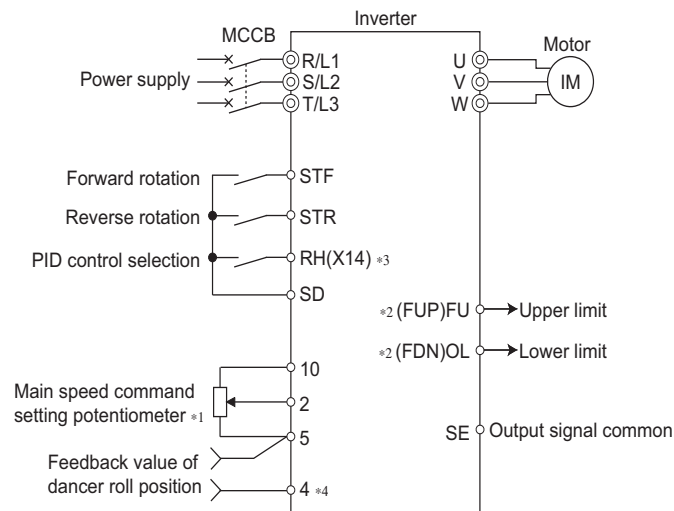

\*1 The main speed command differs according to each operation mode (External, PU, communication).  
 \*2 The applied output terminals differ by the settings of **Pr.190 to Pr.196 (Output terminal function selection)**.  
 \*3 The applied input terminals differ by the settings of **Pr.178 to Pr.189 (Input terminal function selection)**.  
 \*4 The AU signal need not be input.

**◆ Dancer control operation selection (Pr.128)**

Pr.128 setting	PID action	Additive method	Set point input	Measured value input
0	PID disabled	—	—	—
40	Reverse action	Fixed	Set by <b>Pr.133</b> or input by terminal selected by <b>Pr.609</b> <sup>*1</sup>	Input by terminal selected by <b>Pr.610</b>
41	Forward action			
42	Reverse action	Ratio		
43	Forward action			
Others	Refer to <a href="#">page 601</a> .			

\*1 When **Pr.133 ≠ "9999"**, the **Pr.133** setting is valid.

- To enable dancer control, set "40 to 43" in **Pr.128 PID action selection**.
- Dancer control is enabled only when the PID control valid (X14) signal turns ON when "14" is set in one of **Pr.178 to Pr.182 (Input terminal function selection)** and X14 signal is assigned. When the X14 signal is not assigned, dancer control is enabled only by the **Pr.128** setting.
- Input the main speed command (External, PU, Communication). Dancer control is also supported by the main speed command in all operation modes.
- Input the set point between the terminals 2 and 5 (the setting can be selected using **Pr.133** or **Pr.609**) and input the measured value signal (dancer roll position detection signal) between the inverter terminals 4 and 5 (the setting can be selected using **Pr.610**).
- The action of **Pr.129 PID proportional band**, **Pr.130 PID integral time**, **Pr.131 PID upper limit**, **Pr.132 PID lower limit** and **Pr.134 PID differential time** is the same as PID control action. In the relationship between the control amount (%) and frequency in PID control, 0% and 100% are equivalent to the frequencies set to **Pr.902** and **Pr.903**, respectively.

**NOTE**

- When **Pr.128** is set to "0" or the X14 signal is OFF, regular inverter running not dancer control is performed.
- Dancer control is enabled by turning ON/OFF the bits of terminals assigned the X14 signal by RS-485 communication or over the network.
- When dancer control is selected, set the PID output suspension function (**Pr.575 Output interruption detection time** = "9999").
- When **Pr.561 PTC thermistor protection level** ≠ "9999", terminal 2 cannot be used for the main speed command. Terminal 2 becomes the PTC thermistor input terminal.

**◆ Selection of set point/measured value input method (Pr.609, Pr.610)**

- Select the set point input method by **Pr.609 PID set point/deviation input selection** and the measured value input method by **Pr.610 PID measured value input selection**. Switch the power voltage/current specifications of terminals 2 and 4 by **Pr.73 Analog input selection** or **Pr.267 Terminal 4 input selection** to match the specification of the input device.
- When **Pr.133 PID action set point** ≠ "9999", **Pr.133** is the set point. When the set point is set at **Pr.133**, the setting frequency of **Pr.902** is equivalent to 0% and the setting frequency of **Pr.903** is equivalent to 100%.

Pr.609, Pr.610 settings	Input method
1	Terminal 1 <sup>*1</sup>
2	Terminal 2 <sup>*1</sup>
3	Terminal 4 <sup>*1</sup>
4	Communication <sup>*2</sup>
5	PLC function

\*1 When the same input method has been selected for the set point and measured value at **Pr.609** and **Pr.610**, set point input is invalid. (Inverter runs at set point 0%)

\*2 CC-Link, CC-Link IE Field Network, or LONWORKS communication is available. For details on communication, refer to the Instruction Manual of each option.

**NOTE**

- After changing the **Pr.73** or **Pr.267** settings, check the voltage/current input selection switch. Incorrect setting may cause a fault, failure or malfunction. (Refer to [page 496](#) for the setting.)
- When terminals 2 and 4 are selected for deviation input, perform bias calibration using **C3** and **C6** to prevent a minus voltage from being entered as the deviation input signal. Input of a minus voltage might damage devices and the inverter.

- The following shows the relationship between the input values of the analog input terminals, and the set point and measured value.

Input terminal	Input specification <sup>*3</sup>	Relationship with analog input		Calibration parameter
		Set point	Result	
Terminal 2	0 to 5 V	0 V = 0% 5 V = 100%	0 V = 0% 5 V = 100%	<b>Pr.125, C2 to C4</b>
	0 to 10 V	0 V = 0% 10 V = 100%	0 V = 0% 10 V = 100%	
	0 to 20 mA	0 mA = 0% 20 mA = 100%	0 mA = 0% 20 mA = 100%	
Terminal 1	0 to ±5 V	-5 to 0 V = 0% +5 V = +100%	-5 to 0 V = 0% +5 V = +100%	When <b>Pr.128</b> = "10", <b>Pr.125</b> setting, <b>C2 to C4</b> . When <b>Pr.128</b> ≥ "1000", <b>C12</b> setting, <b>C2 to C15</b> .
	0 to 10 V	-10 to 0 V = 0% +10 V = +100%	-10 to 0 V = 0% +10 V = +100%	
Terminal 4	0 to 5 V	0 to 1 V = 0% 5 V = 100%	0 to 1 V = 0% 5 V = 100%	<b>Pr.126, C5 to C7</b>
	0 to 10 V	0 to 2 V = 0% 10 V = 100%	0 to 2 V = 0% 10 V = 100%	
	0 to 20 mA	0 to 4 mA = 0% 20 mA = 100%	0 to 4 mA = 0% 20 mA = 100%	

\*3 Can be changed by **Pr.73** and **Pr.267** and the voltage/current input switch. (Refer to [page 496](#).)

## ◆ Selection of additive method for PID calculation result

- When ratio is selected as the additive method (**Pr.128** = "42, 43"), PID calculation result × (ratio of main speed) is added to the main speed. The ratio is determined by the **Pr.125 Terminal 2 frequency setting gain frequency** and **C2 (Pr.902) Terminal 2 frequency setting bias frequency** settings. In the initial status, 0 to 60 Hz is set for 0 to 100%. Thus, 60 Hz main speed is regarded as 100%, and the 30 Hz main speed is regarded as 50%.

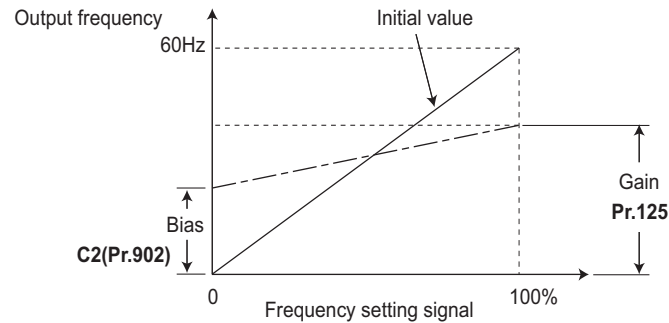

### NOTE

- Even if **C4 (Pr.903)** is set to other than 100%, the frequency setting signal is treated as 100%.
- Even if **C3 (Pr.902)** is set to other than 0%, the frequency setting signal is treated as 0%.
- If **C2 (Pr.902)** is set to other than 0 Hz, the frequency setting signal is 0% at the **C2 (Pr.902)** frequency setting or below.

## ◆ Setting the upper and lower limits of the PID manipulated amount (Pr.1134, Pr.1135)

- Set the upper and lower limits of the PID manipulated amount.
- The upper limit of the manipulated amount is the frequency obtained by adding the value resulting from frequency conversion of **Pr.1134** to the main speed.

The lower limit of the manipulated amount is the frequency obtained by subtracting the value resulting from frequency conversion of **Pr.1135** from the main speed.

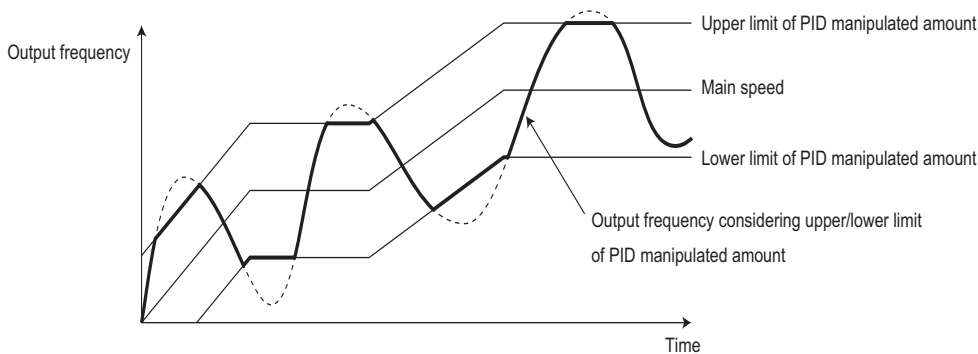

## ◆ Input/output signals

- The following signals can be used by assigning functions to **Pr.178 to Pr.189 (Input terminal function selection)** and **Pr.190 to Pr.196 (Output terminal function selection)**.
- Input signal

Signal	Function	Pr.178 to Pr.189 setting	Description
X14	PID control valid	14	When this signal is assigned to the input terminal, PID control is enabled when this signal is ON.
X64	PID forward/reverse action switchover	64	PID control is switched between forward and reverse action without changing parameters by turning ON this signal.
X72	PID P control switchover	72	Integral and differential values can be reset by turning ON this signal.

- Output signal

Signal	Function	Pr.190 to Pr.196 setting		Description
		Positive logic	Negative logic	
FUP	PID upper limit	15	115	Output when the measured value signal exceeds <b>Pr.131 PID upper limit (Pr.1143 Second PID upper limit)</b> .
FDN	Lower limit output	14	114	Output when the measured value signal falls below <b>Pr.132 PID lower limit (Pr.1144 Second PID lower limit)</b> .
RL	PID forward/reverse rotation output	16	116	"Hi" is output when the output display of the parameter unit is forward rotation (FWD) and "Low" is output when the display is reverse rotation (REV) and stop (STOP).
PID	During PID control activated	47	147	Turns ON during PID control.

#### NOTE

- Changing the terminal functions with **Pr.178 to Pr.189** and **Pr.190 to Pr.196** may affect other functions. Set parameters after confirming the function of each terminal.

### ◆ PID monitor function

- This function displays the PID control set point and measured value on the operation panel, and can output these from the terminals FM, AM, and CA.
- Set the following values to **Pr.52 Operation panel main monitor selection**, **Pr.774 to Pr.776 (Operation panel monitor selection)**, **Pr.992 Operation panel setting dial push monitor selection**, **Pr.54 FM/CA terminal function selection** and **Pr.158 AM terminal function selection** for each monitor.

Parameter Setting	Monitor description	Minimum increment	Monitor range			Remarks
			Terminal FM/CA	Terminal AM	Operation panel	
97	Dancer main set speed	0.01 Hz.	0 to 590 Hz			When outputting through terminals FM, CA and AM, the full scale value can be adjusted by <b>Pr.55 Frequency monitoring reference</b> .

#### NOTE

- Refer to [page 610](#) for details on other PID control monitors.

### ◆ Priority of main speed commands

- The priority of main speed command sources when the speed command source is External is as follows: JOG signal > multi-speed setting signal (RL/RM/RH/REX) > pulse train input > 16-bit digital input (option FR-A8AX) > analog input (terminals 2, 4, 1)
- The priority of main speed command sources when "3" is set to **Pr.79 Operation mode selection** is as follows: Multi-speed setting signal (RL/RM/RH/REX) > frequency setting (digital setting by PU or operation panel)
- Even if the remote operation function is selected by **Pr.59 Remote function selection** ≠ "0", compensation of the remote setting frequency against the main speed is ignored. (The value is "0".)
- If terminal 1 is selected for the first and second PID, terminal 1 added compensation of the main speed is invalid.
- If terminal 2 is selected for the first and second PID, the terminal 2 override function of the main speed is invalid.
- If the same terminal as an external input terminal having a speed command source (external terminal where a main speed is input) is specified as the measured value input or set point input, the main speed is treated as "0".
- Polarity reversible operation of the main speed is not possible.
- Setting "10 to 17" in **Pr.73 Analog input selection** enables the polarity reversible operation of the main speed command to which PID manipulated amount added. (Polarity reversible operation of the main speed command without addition is not possible.)
- When the polarity reversible operation is enabled, the integral term cannot be limited by the maximum and minimum frequency when **Pr.1015 Integral stop selection at limited frequency** = "0 or 10".



## ◆ Adjustment procedure for dancer roll position detection signal

- When the input of terminal 4 is voltage input, 0 V and 5 V (10 V) are the lower limit position and upper limit position, respectively (initial value). When it is current input, 4 mA and 20 mA are the lower limit position and upper limit position, respectively (initial value). When the potentiometer has an output of 0 to 7 V, **C7 (Pr.905)** must be calibrated at 7 V.

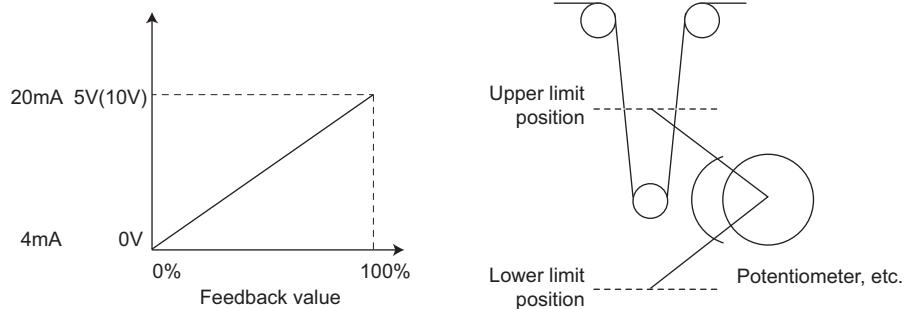

(Example) To execute control at the dancer center position using a 0 to 7 V potentiometer

- Switch the current/voltage input selection switch to "OFF", set "2" to **Pr.267** and set terminal 4 input to voltage input.
- Input 0 V across terminals 4 and 5, and calibrate **C6 (Pr.904)**. (The % display that is indicated at analog calibration is not related to the % of the feedback value.)
- Input 7 V across terminals 4 and 5, and calibrate **C6 (Pr.905)**. (The % display that is indicated at analog calibration is not related to the % of the feedback value.)
- Set **Pr.133** to "50%".

### NOTE

- After changing the **Pr.267** setting, check the voltage/current selection switch. Incorrect setting may cause a fault, failure or malfunction. (Refer to [page 496](#) for the setting.)
- If the Multi-speed operation (RH, RM, RL, or REX) signal, or JOG signal is input during regular PID control, PID control is interrupted. However, at dancer control, these signals are treated as main speed commands, so PID control is continued.
- During dancer control, **Pr.44 and Pr.45** (Second acceleration/deceleration time) is the parameter for setting the acceleration/deceleration time for the main speed command. This function does not work as a second function.
- When the switchover mode is set by setting "6" to **Pr.79**, dancer control (PID control) is invalid.
- The acceleration/deceleration action of the main speed command is the same as that when the frequency is increased or decrease by analog input. The SU signal sometimes stays ON even if operation is turned ON/OFF by the start signal. The set frequency monitor is the value "main speed command + PID control" which is constantly changing.
- With the main speed setting frequency setting, acceleration/deceleration is performed for the acceleration/deceleration time set in **Pr.44 and Pr.45**, and with the output frequency setting, acceleration/deceleration is performed for the acceleration/deceleration time set in **Pr.7 and Pr.8**. For this reason, with the output frequency, when the time set in **Pr.7 and Pr.8** is longer than the time set in **Pr.44 and Pr.45**, acceleration/deceleration is performed for the acceleration/deceleration time set in **Pr.7 and Pr.8**.
- The limit of the integral term is the smaller of 100% and the value after conversion of the straight line after interpolation of **Pr.1 Maximum frequency** by **Pr.902 and Pr.903** to the PID manipulated amount. However, note that the lower limit frequency limits the output frequency, but does not restrict the action of the integral item.

### Parameters referred to

- Pr.57 Restart coasting time** [page 628](#)
- Pr.59 Remote function selection** [page 377](#)
- Pr.73 Analog input selection** [page 496](#)
- Pr.79 Operation mode selection** [page 389](#)
- Pr.178 to Pr.189 (Input terminal function selection)** [page 521](#)
- Pr.190 to Pr.196 (Output terminal function selection)** [page 473](#)
- Pr.561 PTC thermistor protection level** [page 415](#)
- C2 (Pr.902) to C7 (Pr.905) Frequency setting voltage (current) bias/gain** [page 505](#)

## 5.14.14 Automatic restart after instantaneous power failure/flying start with an induction motor

V/F Magnetic flux Sensorless Vector

The inverter can be restarted without stopping the motor operation in the following situations:

- When switching from commercial power supply operation over to inverter running
- When an instantaneous power failure occurs during inverter running
- When the motor is coasting at start

Pr.	Name	Initial value	Setting range	Description
162 A700	Automatic restart after instantaneous power failure selection	0	0, 1000	Frequency search only performed at the first start
			1, 1001	Reduced voltage start only at the first start (no frequency search)
			2, 1002	Encoder detection frequency search
			3, 1003	Frequency search only performed at the first start (reduced impact restart)
			10, 1010	Frequency search at every start
			11, 1011	Reduced voltage start at every start (no frequency search)
			12, 1012	Encoder detection frequency search at every start
			13, 1013	Frequency search at every start (reduced impact restart)
299 A701	Rotation direction detection selection at restarting	0	0	Rotation direction detection disabled
			1	Rotation direction detection enabled
			9999	When <b>Pr.78 Reverse rotation prevention selection</b> = "0", with rotation direction detection When <b>Pr.78 Reverse rotation prevention selection</b> = "1 or 2", without rotation direction detection
57 A702	Restart coasting time	9999	0	Coasting time differs according to the inverter capacity.*1
			0.1 to 30 s	Set the time delay for the inverter to perform a restart after restoring power due to an instantaneous power failure.
			9999	No restart
58 A703	Restart cushion time	1 s	0 to 60 s	Set the voltage cushion time for restart.
163 A704	First cushion time for restart	0 s	0 to 20 s	Set the voltage cushion time for restart.
164 A705	First cushion voltage for restart	0%	0 to 100%	Consider this matched to the size of the load amount (moment of inertia/ torque).
165 A710	Stall prevention operation level for restart	150%	0 to 400%	Set the stall prevention level at restart operation on the assumption that the inverter rated current is 100%.
611 F003	Acceleration time at a restart	9999	0 to 3600 s	Set the acceleration time to reach <b>Pr.20 Acceleration/deceleration reference frequency</b> at restart.
			9999	Standard acceleration time (for example, <b>Pr.7</b> ) is applied as the acceleration time at restart.

\*1 The coasting time when **Pr.57** = "0" is as shown below. (When **Pr.162** and **Pr.570** are set to the initial value.)  
 FR-A820-00105(1.5K) or lower and FR-A840-00052(1.5K) or lower: 0.5 s  
 FR-A820-00167(2.2K) to FR-A820-00490(7.5K) and FR-A840-00083(2.2K) to FR-A840-00250(7.5K): 1 s  
 FR-A820-00630(11K) to FR-A820-03160(55K), FR-A840-00310(11K) to FR-A840-01800(55K): 3.0 s  
 FR-A820-03800(75K) or higher and FR-A840-02160(75K) or higher: 5.0 s

### Point

- To operate the inverter with the automatic restart after instantaneous power failure function enabled, check the following points.
- Set **Pr.57 Restart coasting time** = "0".
- When the Selection of automatic restart after instantaneous power failure / flying start (CS) signal is assigned to the input terminal, restart operation is enabled at turn-ON of the CS signal.

## ◆ Automatic restart after instantaneous power failure function

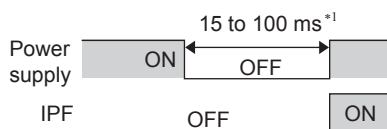

\*1 10 to 100 ms for IP55 compatible models

- The inverter output is shut off at the activation of the Instantaneous power failure (E.IPF) or Undervoltage (E.UVT). (Refer to [page 788](#) for E.IPF or E.UVT.)
- When E.IPF or E.UVT is activated, the Instantaneous power failure/undervoltage (IPF) signal is output.
- The IPF signal is assigned to terminal IPF in the initial status. By setting "2 (positive logic) or 102 (negative logic)" in any of **Pr.190 to Pr.196 (Output terminal function selection)**, the IPF signal can be assigned to another terminal.

- When the automatic restart after instantaneous power failure function is selected, motor driving is resumed at the power restoration after an instantaneous power failure or undervoltage. (E.IPF and E.UVT are not activated.)

## ◆ Connection (CS signal)

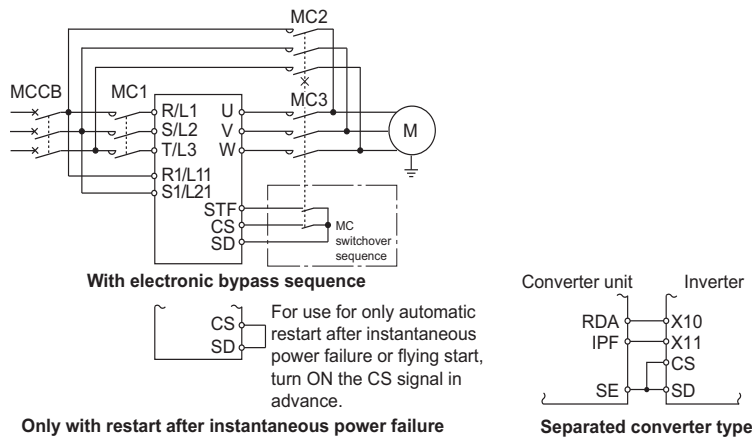

- Restart is enabled at turn-ON of the Selection of automatic restart after instantaneous power failure / flying start (CS) signal.
- The inverter operation is disabled at turn-OFF of the CS signal while **Pr.57 Restart coasting time** ≠ "9999" (with restart).
- Separated converter types detect the instantaneous power failure on the converter unit side. Perform wiring so that the IPF signal transmitted from the converter unit is input to the terminal to which the X11 signal is assigned. On the converter unit side, enable the restart operation. (For setting the converter unit, refer to the Instruction Manual of the converter unit.)
- For the terminal used for the X10 or X11 signal, set "10" (X10) or "11" (X11) in **Pr.178 to Pr.189** and assign the function. (For separated converter types, the X10 signal is assigned to the terminal MRS in the initial setting.)
- For the X10 signal of separated converter types, NC contact input specification is selected in the initial setting. Set **Pr.599** = "0" to change the input specification to NO contact.

### NOTE

- The CS signal is assigned to terminal CS in the initial setting. By setting "6" to any of **Pr.178 to Pr.189** (Input terminal function selection), the CS signal can be assigned to other terminals. Changing the terminal assignment may affect other functions. Set parameters after confirming the function of each terminal.
- If the CS signal is not assigned to any input terminal, solely setting **Pr.57** enables the restart operation at all times.

## ◆ Setting for the automatic restart after instantaneous power failure operation (Pr.162)

- The Pr.162 settings and the instantaneous power failure automatic restart operation under each operation mode are as shown in the following table.

Pr.162 setting	Restart timing	Automatic restart operation selection after instantaneous power failure				CS signal command source selection		
		V/F control, Advanced magnetic flux vector control		Real sensorless vector control	Vector control		PM sensorless vector control	
		Without encoder	With encoder					
0 (initial value)	At first start	Frequency search	Frequency search	Frequency search (reduced impact restart)	Encoder detection frequency search	Frequency search for PM motor (Refer to page 635.)	Always External	
1		Reduced voltage start	Reduced voltage start					
2		Frequency search	Encoder detection frequency search					
3		Frequency search (reduced impact restart)	Frequency search (reduced impact restart)					
10	At every start	Frequency search	Frequency search					
11		Reduced voltage start	Reduced voltage start					
12		Frequency search	Encoder detection frequency search					
13		Frequency search (reduced impact restart)	Frequency search (reduced impact restart)					
1000		Frequency search	Frequency search					
1001	At first start	Reduced voltage start	Reduced voltage start					Determined by the Pr.338 setting
1002		Frequency search	Encoder detection frequency search					
1003		Frequency search (reduced impact restart)	Frequency search (reduced impact restart)					
1010	At every start	Frequency search	Frequency search					
1011		Reduced voltage start	Reduced voltage start					
1012		Frequency search	Encoder detection frequency search					
1013		Frequency search (reduced impact restart)	Frequency search (reduced impact restart)					

5

## ◆ Restart operation with frequency search (Pr.162 = "0, 3, 10, 13, 1000, 1003, 1010, or 1013", Pr.299)

- When Pr.162 = "0 (initial value), 3, 10, 13, 1000, 1003, 1010, or 1013", the motor speed is detected at a power restoration so that the motor can re-start smoothly.
- The encoder also detects the rotation direction so that the inverter can re-start smoothly even during the reverse rotation.
- Whether or not to detect the rotation direction can be selected by **Pr.299 Rotation direction detection selection at restarting**. If the motor capacity is different from the inverter capacity, set Pr.299 = "0" (no rotation direction detection).
- When the rotation direction is detected, the following operation is performed according to **Pr.78 Reverse rotation prevention selection** setting.

Pr.299 setting	Pr.78 setting		
	0	1	2
9999	○	×	×
0 (initial value)	×	×	×
1	○	○	○

○: With rotation direction detection ×: Without rotation direction detection

- By setting "3, 13, 1003, or 1013" in **Pr.162**, the restart can be made smoother with even less impact than when "0, 10, 1000, or 1010" is set in **Pr.162**. When the inverter is restarted with "3, 13, 1003, or 1013" set in **Pr.162**, offline auto tuning is required. (For details on offline auto tuning of Advanced magnetic flux vector control and Real sensorless vector control, refer to [page 532](#), and for details on offline auto tuning of V/F control, refer to [page 638](#).)

#### V/F control, Advanced magnetic flux vector control

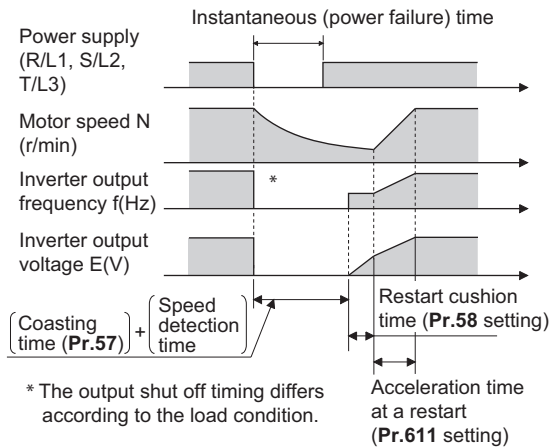

#### Real sensorless vector control

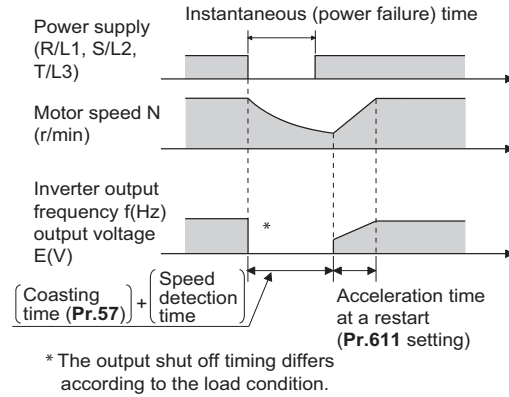

### NOTE

- The rotation speed detection time (frequency search) changes according to the rotation speed of the motor. (maximum 1 s)
- When the inverter capacity is two ranks or greater than the motor capacity, the overcurrent protective function (E.OC[]) is sometimes activated and prevents the inverter from restarting.
- If two or more motors are connected to one inverter, this function operates abnormally. (The inverter does not restart successfully.)
- Because a DC injection brake is applied instantaneously at speed detection during a restart, the speed might drop if the moment of inertia (J) of the load is small.
- If reverse operation is detected when "1" (reverse rotation disabled) is set to **Pr.78**, operation decelerates by reverse rotation and then changes to forward rotation when the start command is forward rotation. The inverter does not restart when the start command is reverse rotation.
- When "3, 13, 1003, or 1013" is set to **Pr.162**, limit the wiring length to within 100 m.

## ◆ Restart operation without frequency search (Pr.162 = "1, 11, 1001, or 1011")

- When **Pr.162** = "1 11, 1001, or 1011", reduced voltage start is used for the restart operation. In this method, the voltage is raised gradually while keeping the output frequency level at the level before an instantaneous power failure, regardless of the motor's coasting speed.

#### V/F control, Advanced magnetic flux vector control

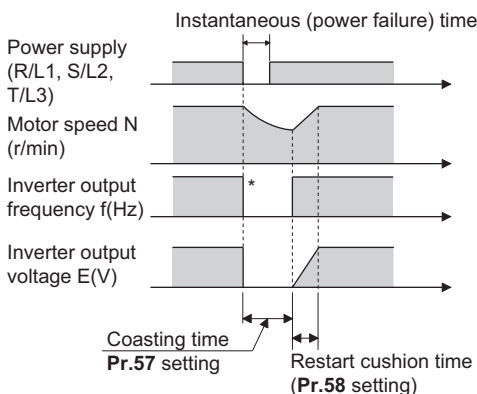

**NOTE**

- This restart method uses the output frequency that was active before the instantaneous power failure stored in memory. If the instantaneous power failure time is 0.2 s or more, the output frequency can no longer be stored and held in memory, so the restart is performed from **Pr.13 Starting frequency** (initial value: 0.5 Hz).
- During Real sensorless vector control, **Pr.162** is set to "3, 13, 1003, or 1013" (reduced impact restart).

**◆ Restart operation with encoder detection frequency search (Pr.162 = "2, 12, 1002, or 1012")**

- When "2, 12, 1002, or 1012" is set in **Pr.162** by encoder feedback control, the inverter is restarted by the motor speed and direction of rotation that were detected by the encoder at the power restoration.
- By encoder detection frequency search, the **Pr.299 Rotation direction detection selection at restarting** settings are invalid.

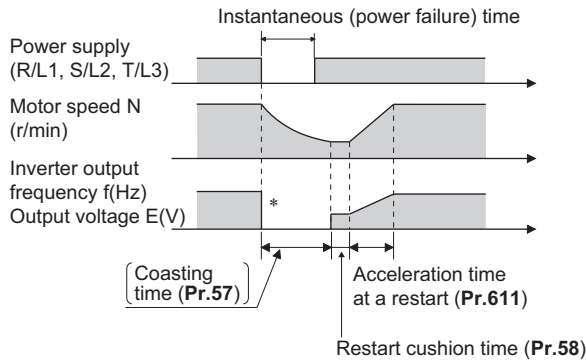

\* The output shut off timing differs according to the load condition.

**NOTE**

- When "2, 12, 1002, or 1012" are set in **Pr.162** when encoder feedback control is invalid, the automatic restart is with a frequency search (**Pr.162** = "0, 10, 1000, or 1010").
- In Vector control, encoder detection frequency search is used regardless of the **Pr.162** setting. The **Pr.58** and **Pr.299** settings are invalid at this time.
- For the encoder feedback control, refer to [page 736](#).

**◆ Restart at every start (Pr.162 = "10 to 13, or 1010 to 1013")**

- When "10 to 13, or 1010 to 1013" is set in **Pr.162**, a restart operation is performed at each start and automatic restart after instantaneous power failure (after the time period set in **Pr.57** elapsed). When "0 (initial value) to 3, or 1000 to 1003" is set in **Pr.162**, a restart operation is performed at the first start after a power-ON, and from the second power-ON onwards, a start from the starting frequency is performed.

**◆ Automatic restart operation of the MRS (X10) signal**

- The restart operation after restoration from output shutoff by the MRS (X10) signal is as shown in the following table according to the **Pr.30** setting.

Pr.30 setting	Operation after restoration from output shutoff by the MRS (X10) signal
2, 10, 11, 102, 110, 111	Restart operation (starting from the coasting speed)
Other than the above	Starting from <b>Pr.13 Starting frequency</b> .

**NOTE**

- When output is shut off using safety stop function (terminals S1 and S2), the inverter restarts in the same way as when output is shut off by the MRS (X10) signal.

**◆ Adjustment of restart coasting time (Pr.57)**

- Restart coasting time is the time period from the occurrence of instantaneous power failure until the operation is restarted after power is restored.  
With frequency search, the motor speed is detected and operation is restarted after the coasting time.

- To enable restart operation, set "0" to **Pr.57 Restart coasting time**. If "0" is set to **Pr.57**, the coasting time is automatically set to the following number of seconds. Generally, this setting does not interfere with inverter operation.

Pr.570 setting	Pr.162 setting	200 V class FR-A820-[]																
		00046 (0.4K)	00077 (0.75K)	00105 (1.5K)	00167 (2.2K)	00250 (3.7K)	00340 (5.5K)	00490 (7.5K)	00630 (11K)	00770 (15K)	00930 (18.5K)	01250 (22K)	01540 (30K)	01870 (37K)	02330 (45K)	03160 (55K)	03800 (75K)	04750 (90K)
		400 V class: FR-A840-[]																
		00023 (0.4K)	00038 (0.75K)	00052 (1.5K)	00083 (2.2K)	00126 (3.7K)	00170 (5.5K)	00250 (7.5K)	00310 (11K)	00380 (15K)	00470 (18.5K)	00620 (22K)	00770 (30K)	00930 (37K)	01160 (45K)	01800 (55K)	02160 (75K)	02600 (90K) or higher
0 (SLD), 1 (LD)	Other than 3, 13, 1003, 1013	0.5	0.5	1	1	1	1	3	3	3	3	3	3	3	5	5	5	
	3, 13, 1003, 1013	1	1	2	2	2	2	3	3	3	3	3	3	3	5	5	5	
2 (ND)	Other than 3, 13, 1003, 1013	0.5	0.5	0.5	1	1	1	1	3	3	3	3	3	3	3	5	5	
	3, 13, 1003, 1013	1	1	1	2	2	2	2	3	3	3	3	3	3	3	5	5	
3 (HD)	Other than 3, 13, 1003, 1013	0.5	0.5	0.5	0.5	1	1	1	1	3	3	3	3	3	3	3	3	5
	3, 13, 1003, 1013	1	1	1	1	2	2	2	2	3	3	3	3	3	3	3	3	5

Interruption > Pr.57 setting

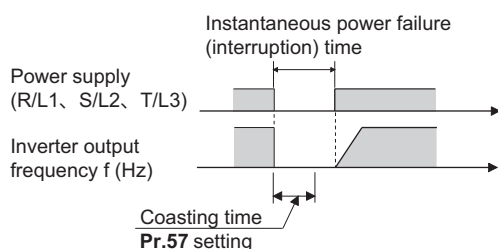

Interruption ≤ Pr.57 setting

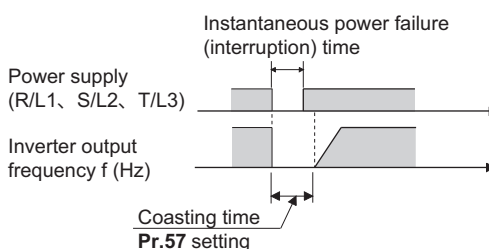

- Inverter operation is sometimes hindered by the size of the moment of inertia (J) of the load, output frequency, or the residual magnetic flux in the motor. Adjust this coasting time within the range 0.1 to 30 seconds to match the load specification.
- Set 3 seconds or more time delay when the sine wave filter is used (**Pr.72 PWM frequency selection** = "25").

#### NOTE

- Note that the coasting time setting is different from that of the FR-A700 series inverter. (Refer to [page 856](#).)

### ◆ Restart cushion time (Pr.58)

- The cushion time is the time taken to raise the voltage to the level required for the specified speed after the motor speed detection (output frequency before the instantaneous power failure when **Pr.162** = "1, 11, 1001, or 1011").
- Normally, the motor runs at the initial value as it is. However, adjust to suit the moment of inertia (J) of the load or the size of the torque.

#### NOTE

- Pr.58** is invalid under Real sensorless vector control or Vector control.

## ◆ Adjustment of restart operation (Pr.163 to Pr.165, Pr.611)

- The voltage cushion time at a restart can be adjusted by **Pr.163** and **Pr.164** as shown in the figure on the left.

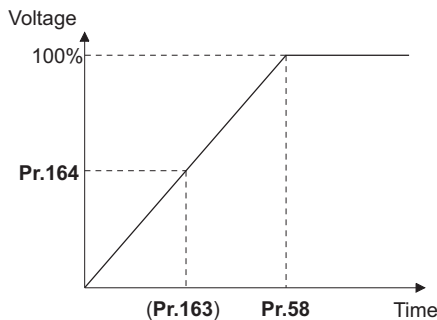

- The stall prevention operation level at a restart operation can be set in **Pr.165**.
- Using **Pr.611**, the acceleration time to reach **Pr.20 Acceleration/deceleration reference frequency** after a restart operation can be set. This can be set individually from the normal acceleration time.

5

### NOTE

- **Pr.163 to Pr.165** are invalid under Real sensorless vector control and Vector control.
- Changing the **Pr.21** setting does not affect the **Pr.611** setting increment.
- Changing the terminal assignment using **Pr.178 to Pr.189 (Input terminal function selection)** may affect the other functions. Set parameters after confirming the function of each terminal.
- When the restart operation is selected, Undervoltage (E.UVT) and Instantaneous power failure (E.IPF) of the fault output signals become invalid.
- The SU and FU signals are not output during the restart. These signals are output after the restart cushion time passes.
- Restart operation is also performed after the inverter reset is released or after the retry by the retry function occurs.
- The automatic restart after instantaneous power failure function is invalid when the load torque high-speed frequency control (**Pr.270** = "2, 3, or 13") is set.

## ◆ Operation command source selection for the CS signal during communication operation (Pr.162 = "1000 to 1003, 1010 to 1013")

- When "1000 to 1003, or 1010 to 1013" is set in **Pr.162**, the CS signal input via communication is enabled depending on the setting in **Pr.338 Communication operation command source**. (When **Pr.162** = "0 to 3, or 10 to 13", the CS signal can be input via an external terminal only.)

### ⚠ CAUTION

- **Provide a mechanical interlock for MC1 and MC2. The inverter will be damaged if power supply is input to the inverter output section.**
- **When the automatic restart after instantaneous power failure function is selected, the motor suddenly starts (after reset time passes) when an instantaneous power failure occurs. Stay away from the motor and machinery. Apply the supplied CAUTION stickers to easily visible places when automatic restart after instantaneous power failure has been selected.**

#### ◀ Parameters referred to ▶

Pr.7 Acceleration time, Pr.21 Acceleration/deceleration time increments [page 367](#)  
Pr.13 Starting frequency [page 381](#), [page 382](#)  
Pr.65, Pr.67 to Pr.69 Retry function [page 426](#)  
Pr.78 Reverse rotation prevention selection [page 406](#)  
Pr.178 to Pr.189 (Input terminal function selection) [page 521](#)

## 5.14.15 Automatic restart after instantaneous power failure/flying start with a PM motor



When using the IPM motor MM-CF, the inverter operation can be restarted without stopping the motor operation.

When the automatic restart after instantaneous power failure function is selected, the motor driving is resumed in the following situations:



- When power comes back ON during inverter driving after an instantaneous power failure
- When the motor is coasting at start

Pr.	Name	Initial value	Setting range	Description
57 A702	Restart coasting time	9999	0	No delay
			0.1 to 30 s	Set the delay time for the inverter to perform a restart after restoring power due to an instantaneous power failure.
			9999	No restart
162 A700	Automatic restart after instantaneous power failure selection	0	0 to 3, 1000 to 1003	Frequency search only performed at the first start
			10 to 13, 1010 to 1013	Frequency search at every start
611 F003	Acceleration time at a restart	9999	0 to 3600 s	Set the acceleration time to reach <b>Pr.20 Acceleration/deceleration reference frequency</b> at restart.
			9999	Standard acceleration time (for example, <b>Pr.7</b> ) is applied as the acceleration time at restart.

## ◆ Automatic restart after instantaneous power failure function

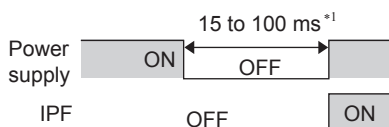

\*1 10 to 100 ms for IP55 compatible models

- The inverter output is shut off at the activation of the Instantaneous power failure (E.IPF) or Undervoltage (E.UVT). (Refer to [page 779](#) for E.IPF or E.UVT.)
- When E.IPF or E.UVT is activated, the Instantaneous power failure/undervoltage (IPF) signal is output.
- The IPF signal is assigned to terminal IPF in the initial status. By setting "2 (positive logic) or 102 (negative logic)" in any of **Pr.190 to Pr.196 (Output terminal function selection)**, the IPF signal can be assigned to another terminal.
- When the automatic restart after instantaneous power failure function is selected, motor driving is resumed at the power restoration after an instantaneous power failure or undervoltage. (E.IPF and E.UVT are not activated.)

## ◆ Connection (CS signal)

- When the Selection of automatic restart after instantaneous power failure / flying start (CS) signal is assigned to an input terminal (initial setting), a restart operation is enabled at turn-ON of the CS signal.
- The inverter operation is disabled at turn-OFF of the CS signal while **Pr.57 Restart coasting time** ≠ "9999" (with restart).

### NOTE

- The CS signal is assigned to terminal CS in the initial setting. By setting "6" to any of **Pr.178 to Pr.189** (Input terminal function selection), the CS signal can be assigned to other terminals. Changing the terminal assignment may affect other functions. Set parameters after confirming the function of each terminal.
- If the CS signal is not assigned to any input terminal, solely setting **Pr.57** enables the restart operation at all times.
- If the restart operation is selected, instantaneous power failure (E.IPF) is disabled while the fault output signal is output at an instantaneous power failure.
- The SU and FU signals are not output during the restart. These signals are output after the restart cushion time passes.
- Restart operation is also performed after the inverter reset is released or after the retry by the retry function occurs.
- The automatic restart after instantaneous power failure function is invalid when the load torque high-speed frequency control (**Pr.270** = "2, 3, 13") is set.

## ◆ Selection of restart operation (Pr.162)

- At a power restoration, the encoder detects the motor speed by a frequency search so that the inverter can re-start smoothly.
- The encoder also detects the rotation direction so that the inverter can re-start smoothly even during the reverse rotation.

- When "10 to 13, or 1010 to 1013" is set in **Pr.162**, a restart operation is performed at each start and automatic restart after instantaneous power failure. When "0 to 2, or 1000 to 1002" is set in **Pr.162**, a restart operation is performed at the first start after a power-ON, and from the second power-ON onwards, a start from the starting frequency is performed.

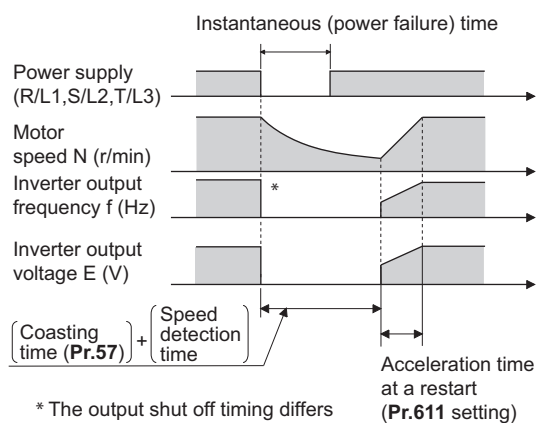

## NOTE

- Because a DC injection brake is applied instantaneously at speed detection during a restart, the speed might drop if the moment of inertia (J) of the load is small.
- Restart operation with reduced voltage is not available for PM sensorless vector control.

## ◆ Restart coasting time (Pr.57)

- Coasting time is the time from the motor speed detection to the restart operation start.
- To enable restart operation, set "0" (no coasting time) in **Pr.57 Restart coasting time**. Generally, this setting does not interfere with inverter operation.
- Inverter operation is sometimes hindered by the size of the moment of inertia (J) of the load or the output frequency. Adjust this coasting time within the range 0.1 to 30 seconds to match the load specification.

## ◆ Adjustment of restart operation (Pr.611)

- Using **Pr.611**, the acceleration time to reach **Pr.20 Acceleration/deceleration reference frequency** after a restart operation can be set. This can be set individually from the normal acceleration time.

## NOTE

- Changing the **Pr.21 Acceleration/deceleration time increments** setting does not affect the **Pr.611** setting increment.
- An IPM motor is a motor with interior permanent magnets. Regeneration voltage is generated when the motor coasts at an instantaneous power failure or at a flying start. The inverter's DC bus voltage rises if the motor coasts fast or makes a flying start in this condition.

When using the automatic restart after instantaneous power failure function (**Pr.57** ≠ "9999"), it is recommended to also use the regenerative avoidance function (**Pr.882 Regeneration avoidance operation selection** = "1") to make startups stable. If the overvoltage protective function (E.OV[]) still occurs with the regeneration avoidance function, also use the retry function (**Pr.67**).

- During PM sensorless vector control, the automatic restart after instantaneous power failure function operates only when an IPM MM-CF motor is connected.

When a built-in brake or a regeneration unit is used, the frequency search may not be available at 2200 r/min or higher. The restart operation cannot be performed until the motor speed drops to a frequency where the frequency search is available.

## CAUTION

- An IPM motor is a motor with interior permanent magnets. High voltage is generated at motor terminals while the motor is running.  
Do not touch motor terminals and other parts until the motor stops to prevent an electric shock.
- When the automatic restart after instantaneous power failure function is selected, the motor suddenly starts (after reset time passes) when an instantaneous power failure occurs.  
Stay away from the motor and machinery.  
Apply the supplied CAUTION stickers to easily visible places when automatic restart after instantaneous power failure has been selected.

### Parameters referred to

Pr.13 Starting frequency [page 381](#), [page 382](#)  
 Pr.65, Pr.67 to Pr.69 Retry function [page 426](#)  
 Pr.78 Reverse rotation prevention selection [page 406](#)  
 Pr.178 to Pr.189 (Input terminal function selection) [page 521](#)  
 Pr.882 Regeneration avoidance operation selection [page 732](#)

## 5.14.16 Offline auto tuning for a frequency search



Under V/F control or when driving the IPM motor MM-CF, the accuracy of the "frequency search", which is used to detect the motor speed for the automatic restart after instantaneous power failure and flying start, can be improved.

Pr.	Name	Initial value	Setting range	Description
162 A700	Automatic restart after instantaneous power failure selection	0	0, 1000	Frequency search only performed at the first start
			1, 1001	Reduced voltage start only at the first start (no frequency search)
			2, 1002	Encoder detection frequency search
			3, 1003	Frequency search only performed at the first start (reduced impact restart)
			10, 1010	Frequency search at every start
			11, 1011	Reduced voltage start at every start (no frequency search)
			12, 1012	Encoder detection frequency search at every start
			13, 1013	Frequency search at every start (reduced impact restart)
298 A711*1	Frequency search gain	9999	0 to 32767	The offline auto tuning automatically sets the gain required for the frequency search.
			9999	The constant value of Mitsubishi Electric motor (SF-PR, SF-JR, SF-HR, SF-JRCA, SF-HRCA, or MM-CF) is used.
560 A712*1	Second frequency search gain	9999	0 to 32767	The offline auto tuning automatically sets the gain required for the frequency search of the second motor.
			9999	The constant value of Mitsubishi Electric motor (SF-PR, SF-JR, SF-HR, SF-JRCA, SF-HRCA, or MM-CF) is used for the second motor.
96 C110	Auto tuning setting/status	0	0	No offline auto tuning
			1, 101	Offline auto tuning is performed under Advanced magnetic flux vector control, Real sensorless vector control, or Vector control. (Refer to <a href="#">page 532</a> and <a href="#">page 542</a> .)
			11	Offline auto tuning is performed without rotating the motor (for IPM motor MM-CF).
90 C120	Motor constant (R1)	9999	0 to 50 Ω, 9999*2	Tuning data (The value measured by offline auto tuning is automatically set.)
			0 to 400 mΩ, 9999*3	9999: The constant value of Mitsubishi Electric motor (SF-PR, SF-JR, SF-HR, SF-JRCA, SF-HRCA and so on) is used.
463 C210	Second motor auto tuning setting/status	0	0	No auto tuning for the second motor.
			1, 101	Offline auto tuning is performed for the second motor. (Refer to <a href="#">page 532</a> and <a href="#">page 542</a> .)
			11	Offline auto tuning is performed without rotating the second motor (under V/F control or PM sensorless vector control (IPM motor MM-CF)).
458 C220	Second motor constant (R1)	9999	0 to 50 Ω, 9999*2	Tuning data of the second motor (same as Pr.90)
			0 to 400 mΩ, 9999*3	

\*1 Tuning is not available under PM sensorless vector control.

\*2 For the FR-A820-03160(55K) or lower, and FR-A840-01800(55K) or lower.

\*3 For the FR-A820-03800(75K) or higher, and FR-A840-02160(75K) or higher.

## ◆ Offline auto tuning for a frequency search (reduced impact restart)

- When an induction motor is used and the frequency search (reduced impact restart) is selected by setting **Pr.162 Automatic restart after instantaneous power failure selection** = "3, 13, 1003, or 1013", perform offline auto tuning.
- When the MM-CF motor is used and the automatic restart after instantaneous power failure is selected, it is recommended that offline auto tuning is performed.

## ◆ Before performing offline auto tuning

Check the following points before performing offline auto tuning:

- Check that V/F control or PM sensorless vector control (IPM motor MM-CF) is selected.
- Check that a motor is connected. (Check that the motor is not rotated by an external force during tuning.)
- Select a motor with the rated current equal to or less than the inverter rated current. (The motor capacity must be 0.4 kW or higher.)  
If a motor with substantially low rated current compared with the inverter rated current is used, speed and torque accuracies may deteriorate due to torque ripples, etc. Set the rated motor current to about 40% or higher of the inverter rated current.
- The target motor is other than a high-slip motor, a high-speed motor, or a special motor.
- The motor may rotate slightly even if the offline auto tuning without motor rotation (**Pr.96 Auto tuning setting/status** = "11") is selected. Fix the motor securely with a mechanical brake, or before tuning, make sure that it is safe even if the motor rotates. (Caution is required especially in vertical lift applications.) Note that even if the motor runs slightly, tuning performance is unaffected.
- Offline auto tuning is not performed correctly when the surge voltage suppression filter (FR-ASF-H/FR-BMF-H) and sine wave filter (MT-BSL/BSC) are inserted between the inverter and motor. Be sure to remove them before performing tuning.

## ◆ Setting



1. Set "11" in **Pr.96 Auto tuning setting/status**.
2. Set the rated motor current (initial value is inverted rated current) in **Pr.9 Electronic thermal O/L relay**. (Refer to [page 415](#).)
3. Set **Pr.71 Applied motor** according to the motor to be used.

Motor	Pr.71 setting	
Mitsubishi Electric standard motor Mitsubishi Electric high-efficiency motor	SF-JR, SF-TH	0 (3, 4)
	SF-JR 4P 1.5 kW or lower	20 (23, 24)
	SF-HR	40 (43, 44)
	Others	0 (3, 4)
Mitsubishi Electric constant-torque motor	SF-JRCA 4P, SF-TH (constant-torque)	1 (13, 14)
	SF-HRCA	50 (53, 54)
	Others (SF-JRC, etc.)	1 (13, 14)
Mitsubishi Electric high-performance energy-saving motor	SF-PR	70 (73, 74)
Other manufacturer's standard motor	—	0 (3, 4)
Other manufacturer's constant-torque motor	—	1 (13, 14)

## ◆ Performing tuning

### Point



- Before performing tuning, check the monitor display of the operation panel or parameter unit if the inverter is in the state ready for tuning. The motor starts by turning ON the start command while tuning is unavailable.

- In the PU operation mode, press  /  on the operation panel.  
For External operation, turn ON the start command (STF signal or STR signal). Tuning starts. (At this time, excitation noise occurs.)

**NOTE**

- It takes about 10 s for tuning to complete. (The time depends on the inverter capacity and motor type.)
- Satisfy the required inverter start conditions to start offline auto tuning. For example, stop the input of the MRS signal.
- To force tuning to end, use the MRS or RES signal or  on the operation panel.  
(Turning OFF the start signal (STF signal or STR signal) also ends tuning.)
- During offline auto tuning, only the following I/O signals are valid (initial value).  
Input terminals <valid signals>: STP (STOP), OH, MRS, RT, RES, STF, STR, S1, and S2  
Output terminals: RUN, OL, IPF, FM/CA, AM, A1B1C1, and So (SO)
- When the rotation speed and the output frequency are selected for terminals FM/CA and AM, the progress status of offline auto tuning is output in 15 steps from FM/CA and AM.
- Do not perform ON/OFF switching of the Second function selection (RT) signal during offline auto tuning. Auto tuning will not be performed properly.
- Since the RUN signal turns ON when tuning is started, pay close attention especially when a sequence which releases a mechanical brake by the RUN signal has been designed.
- When executing offline auto tuning, input the operation command after switching ON the main circuit power (R/L1, S/L2, T/L3) of the inverter.
- While **Pr.79 Operation mode selection** = "7", turn the PU operation external interlock (X12) signal ON to tune in the PU operation mode.

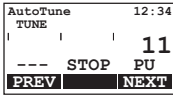
- During tuning, the monitor is displayed on the operation panel as follows.

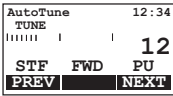
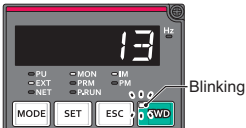
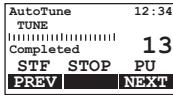
Status	Operation panel (FR-DU08) display	LCD operation panel (FR-LU08) display
Setting		
Tuning in progress		
Normal end		

- When offline auto tuning ends, press  on the operation panel during PU operation. For External operation, turn OFF the start signal (STF signal or STR signal). This operation resets the offline auto tuning, and the PU's monitor display returns to the normal indication. (Without this operation, next operation cannot be started.)
- At tuning completion, the tuning results are set in the following parameters:

Parameter	Name
90	Motor constant (R1)
298	Frequency search gain
96	Auto tuning setting/status

**NOTE**

- The motor constants measured once during offline auto tuning are stored as parameters and their data are held until offline auto tuning is performed again. However, the tuning data is cleared when performing All parameter clear.

- If offline auto tuning has ended in error, motor constants are not set.

Perform an inverter reset and perform tuning again.

Error display	Error cause	Countermeasures
8	Forced end	Set "11" in <b>Pr.96</b> and retry.
9	Inverter protective function operation	Make the setting again.
91	The current limit (stall prevention) function is activated.	Set the acceleration/deceleration time longer. Set <b>Pr.156 Stall prevention operation selection</b> = "1".
92	The converter output voltage fell to 75% of the rated voltage.	Check for the power supply voltage fluctuation.
93	Calculation error. The motor is not connected.	Check the motor wiring and make the setting again.
94	Rotation tuning frequency setting error. (The frequency command for the tuning was given to exceed the maximum frequency setting, or to be in the frequency jump range.)	Check the <b>Pr.1 Maximum frequency</b> and <b>Pr.31 to Pr.36 Frequency jump</b> settings.

- When tuning is ended forcibly by pressing  or turning OFF the start signal (STF or STR) during tuning, offline auto tuning does not end properly. (The motor constants have not been set.)  
Perform an inverter reset and perform tuning again.
- When the rated power supply of the motor is 200/220 V (400/440 V) 60 Hz, set the rated motor current multiplied by 1.1 in **Pr.9 Electronic thermal O/L relay** after tuning is complete.
- For a motor with a PTC thermistor, thermal protector or other thermal detection, set "0" (motor overheat protection by inverter invalid) in **Pr.9** to protect the motor from overheating.

#### NOTE

- An instantaneous power failure occurring during tuning will result in a tuning error. After power is restored, the inverter starts normal operation. Therefore, when the STF (STR) signal is ON, the motor starts forward (reverse) rotation.
- Any fault occurring during tuning is handled as in the normal operation. However, if the retry function is set, no retry is performed.
- The set frequency monitor displayed during the offline auto tuning is 0 Hz.

### ◆ Tuning the second motor (Pr.463)

- When one inverter switches the operation between two different motors, set the second motor in **Pr.450 Second applied motor**, set **Pr.463 Second motor auto tuning setting/status** = "11", and perform tuning of the second motor.
- Turning ON the RT signal enables the parameter settings for the second motor as shown in the following table.

Function	RT signal ON (second motor)	RT signal OFF (first motor)
Motor constant (R1)	<b>Pr.458</b>	<b>Pr.90</b>
Frequency search gain	<b>Pr.560</b>	<b>Pr.298</b>
Auto tuning setting/status	<b>Pr.463</b>	<b>Pr.96</b>







#### NOTE

- The RT signal is assigned to terminal RT in the initial status. Set "3" in one of **Pr.178 to Pr.189 (Input terminal function selection)** to assign the RT signal to another terminal.
- Changing the terminal assignment using **Pr.178 to Pr.189 (Input terminal function selection)** may affect the other functions. Set parameters after confirming the function of each terminal.

### ⚠ CAUTION

- Note that the motor may start running suddenly.
- For the offline auto tuning in vertical lift applications, etc., caution is required to avoid falling due to insufficient torque.

#### Parameters referred to

**Pr.9 Electronic thermal O/L relay**  page 415  
**Pr.65, Pr.67 to Pr.69 Retry function**  page 426  
**Pr.71 Applied motor, Pr.450 Second applied motor**  page 528  
**Pr.79 Operation mode selection**  page 389  
**Pr.156 Stall prevention operation selection**  page 431  
**Pr.178 to Pr.189 (Input terminal function selection)**  page 521

# 5.14.17 Power failure time deceleration-to-stop function

This is a function to decelerate the motor to a stop when an instantaneous power failure or undervoltage occurs.

Pr.	Name	Initial value		Setting range	Description
		FM	CA		
261 A730	Power failure stop selection	0		0	Power failure time deceleration-to-stop function disabled
				1, 2, 11, 12, 21, 22	Power failure time deceleration-to-stop function enabled. Select action at an undervoltage or when a power failure occurs.
262 A731	Subtracted frequency at deceleration start	3 Hz		0 to 20 Hz	Normally, the motor runs at the initial value as it is. However, adjust to suit the size of the load specification (moment of inertia, torque).
263 A732	Subtraction starting frequency	60 Hz	50 Hz	0 to 590 Hz	When the output frequency $\geq$ the frequency set in <b>Pr.263</b> : The motor decelerates if the output frequency decreases by the frequency set in <b>Pr.262</b> . When the output frequency $<$ the frequency set in <b>Pr.263</b> : The motor decelerates at frequencies of the output frequency.
				9999	The motor decelerates from the output frequency - <b>Pr.262</b> .
264 A733	Power-failure deceleration time 1	5 s		0 to 3600 s	Set the slope applicable from the deceleration start to the <b>Pr.266</b> set frequency.
265 A734	Power-failure deceleration time 2	9999		0 to 3600 s	Set the slope applicable for the frequency range starting at <b>Pr.266</b> and downward.
				9999	Same as <b>Pr.264</b> .
266 A735	Power failure deceleration time switchover frequency	60 Hz	50 Hz	0 to 590 Hz	Set the frequency at which the slope during deceleration switches from the <b>Pr.264</b> setting to the <b>Pr.265</b> setting.
294 A785	UV avoidance voltage gain	100%		0 to 200%	Adjust the response at undervoltage avoidance operation. Setting a large value improves the response to changes in the bus voltage.
668 A786	Power failure stop frequency gain	100%		0 to 200%	Adjust the response level for the operation where the deceleration time is automatically adjusted.
606 T722	Power failure stop external signal input selection	1		0	Normally open input (NO contact input specification)
				1	Normally closed input (NC contact input specification)

## ◆ Connection and parameter setting

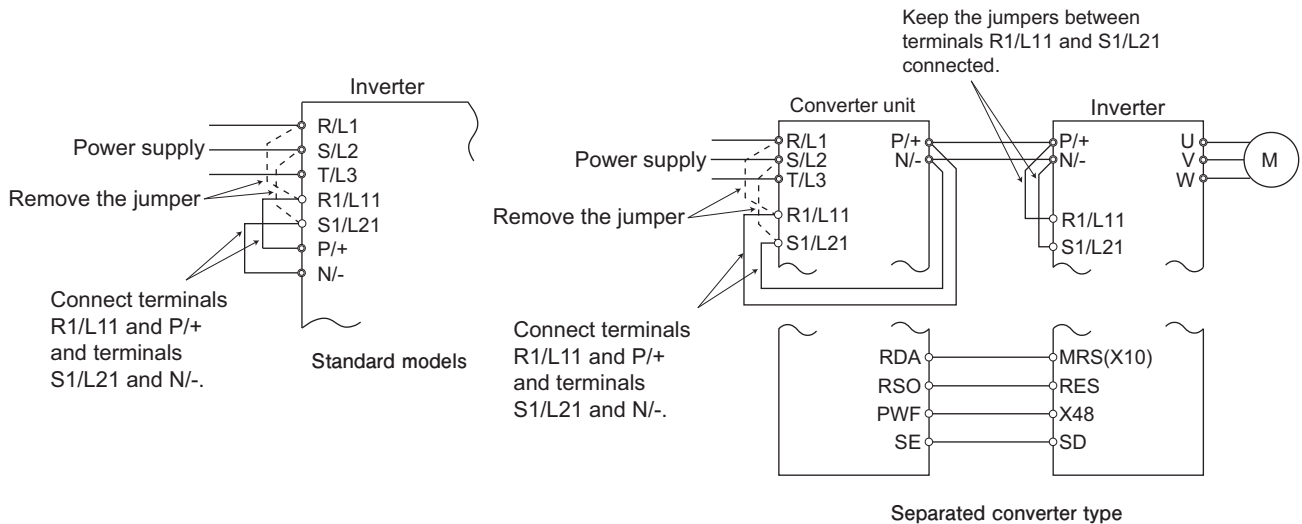

- For the standard model, remove the jumpers between terminals R/L1 and R1/L11 and terminals S/L2 and S1/L21, and connect terminals R1/L11 and P/+ and terminals S1/L21 and N/-.
- If an undervoltage, power failure or input phase loss occurs when **Pr.261 Power failure stop selection**  $\neq$  "0", the motor decelerates to a stop.

- The power failure time deceleration-to-stop function operates as follows at an input phase loss.

Pr.261	Pr.872	Operation when an input phase loss occurs
0	0	Operation continues
	1	Input phase loss (E.ILF)
1, 2	0	Operation continues
	1	Deceleration stop
21, 22	—	Deceleration stop

- For the separated converter type, remove the jumpers between terminals R/L1 and R1/L11 and terminals S/L2 and S1/L21 of the converter unit, and connect terminals R1/L11 and P/+ and terminals S1/L21 and N/-. Do not remove the jumpers of terminal R1/L11 and terminal S1/L21 of the inverter. (In the initial status of the separated converter type, terminals P/+ and R1/L11 and terminals N/- and S1/L21 are connected.)
- For the separated converter type, connect the terminal to which the PWF signal of the converter unit is assigned and the terminal to which the X48 signal of the inverter is assigned. Also, set **Pr.261** of the converter unit in accordance with the inverter setting. (Refer to the Instruction Manual of the converter unit.)

### ◆ Outline of operation of deceleration stop at a power failure

- If an undervoltage or power failure occurs, the output frequency is turned OFF only for the frequency set to **Pr.262 Subtracted frequency at deceleration start**.
- The motor decelerates for the time set to **Pr.264 Power-failure deceleration time 1**. (The deceleration time setting is the time it takes for the motor to stop from **Pr.20 Acceleration/deceleration reference frequency**.)
- Change the deceleration time (slope) to stop using **Pr.265 Power-failure deceleration time 2** when the frequency is too low to obtain the regenerative energy or in other instances.

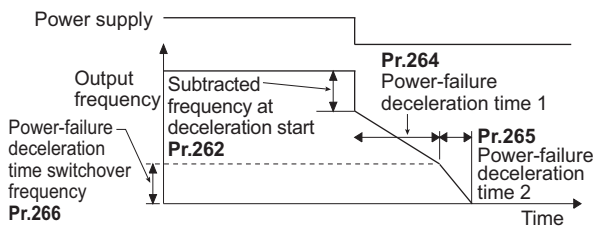

### ◆ Action setting at undervoltage and power failure

- Set **Pr.261** to select the action at an undervoltage and power failure.

Pr.261 setting	Action at undervoltage and power failure	Power restoration during deceleration at occurrence of power failure	Deceleration stop time	Undervoltage avoidance function
0	Coasts to stop	Coasts to stop	—	—
1	Deceleration stop	Deceleration stop	According to <b>Pr.262 to Pr.266</b> setting	Not available
2		Re-acceleration		Not available
11		Deceleration stop	Automatic adjustment of deceleration time	Available
12		Re-acceleration		Available
21		Deceleration stop	Re-acceleration	Not available
22		Re-acceleration		Not available



## ◆ Power failure stop function (Pr.261 = "1, 11, or 21")

- Even if power is restored during deceleration triggered by a power failure, deceleration stop is continued after which the inverter stays stopped. To restart operation, turn the start signal OFF then ON again.

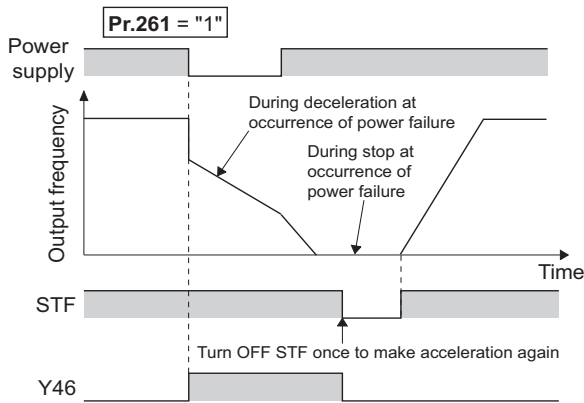

### NOTE

- If the automatic restart after instantaneous power failure is selected (**Pr.57 Restart coasting time** ≠ "9999") while the power failure time deceleration-to-stop function is set enabled (**Pr.261 = "1, 11, or 21"**), the power failure time deceleration stop function is disabled.
- When the power failure time deceleration-to-stop function is enabled (**Pr.261 = "1, 11 or 21"**), the inverter does not start even if the power is turned ON or inverter reset is performed with the start signal (STF/STR) ON. Turn OFF the start signal once and then ON again to make a start.

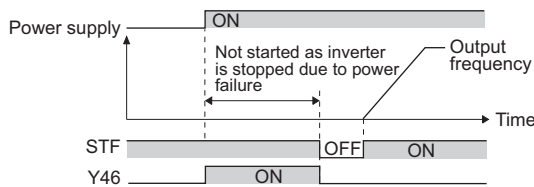

- During cyclic transmission or the like (in which start commands are periodically transmitted), operation is restarted if the power is restored during the deceleration even when the power failure time deceleration-to-stop function is enabled.

## ◆ Continuous operation function at instantaneous power failure (Pr.261 = "2, 12, or 22")

- The motor re-accelerates to the set frequency when the power restores during the deceleration triggered by a power failure.
- Combining with the automatic restart after instantaneous power failure function enables a deceleration triggered by a power failure and re-acceleration at a power restoration.

If the power is restored after stoppage by a power failure, a restart operation is performed when automatic restart after instantaneous power failure (**Pr.57** ≠ "9999") is selected.

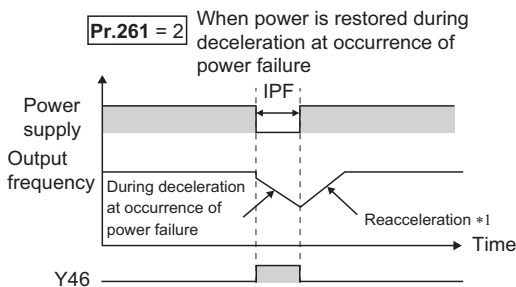

\*1 Acceleration time depends on **Pr.7 (Pr.44)**

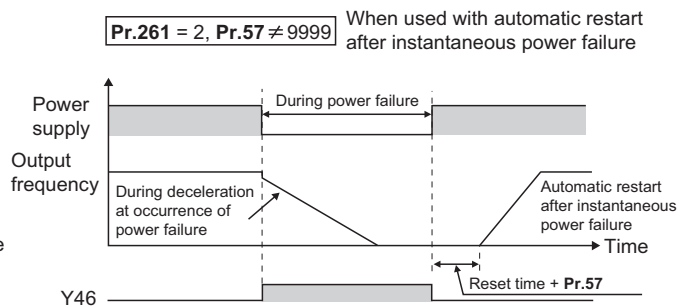

## ◆ Undervoltage avoidance function (Pr.261 = "11 or 12", Pr.294)

- When "11 or 12" is set to **Pr.261**, the deceleration time is adjusted (shortened) to prevent an undervoltage from occurring during deceleration at occurrence of power failure.

- Adjust the downward frequency slope and the response level using **Pr.294 UV avoidance voltage gain**. Setting a large value improves the response to the bus voltage.

#### NOTE

- The undervoltage avoidance function is invalid under torque control by Real sensorless vector control. When **Pr.261** = "11 (12)", the operation is performed in the same manner as if **Pr.261** = "1 (2)".

### ◆ Automatic adjustment of deceleration time (Pr.261 = "21 or 22", Pr.294, Pr.668)

- When "21 or 22" is set to **Pr.261**, the deceleration time is automatically adjusted to keep (DC bus) voltage constant in the converter when the motor decelerates to a stop at a power failure. Setting of **Pr.262 to Pr.266** is not required.
- If a phenomenon such as motor vibration occurs during operation of the deceleration time automatic adjustment function, adjust the response level by setting the **Pr.668 Power failure stop frequency gain**. Increasing the setting improves the response to change in the bus voltage. However, the output frequency may become unstable.
- If setting **Pr.294 UV avoidance voltage gain** lower also does not suppress the vibration, set **Pr.668** lower.

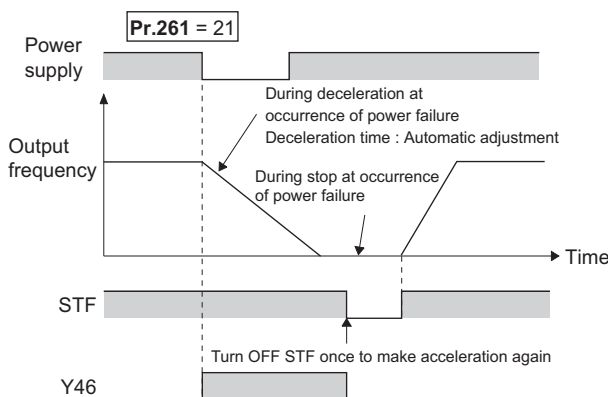

### ◆ Deceleration stop by the Power failure stop external (X48) signal

- By turning OFF X48 signal, the power failure time deceleration-to-stop function is activated. This function is used, for example, when an external power failure detection circuit is installed.
- To use the power failure time deceleration-to-stop function for the separated converter type, use X48 signal. Connect the terminal to which the PWF signal of the converter unit is assigned and the terminal to which the X48 signal of the inverter is assigned.
- In the initial setting, the X48 signal is used with the normally closed (NC contact) input specification. Use **Pr.606 Power failure stop external signal input selection** to change the specification to the normally open (NO contact) input.
- To use the X48 signal, set "48" in any of **Pr.178 to Pr.189 (Input terminal function selection)** to assign the function to an input terminal.

### ◆ During deceleration at occurrence of power failure (Y46) signal

- After deceleration by a power failure, the inverter is not restarted even though the start command is input. Check the During deceleration at occurrence of power failure (Y46) signal at a power failure. (For example, when input phase loss protection (E.ILF) occurs.)
- The Y46 signal is turned ON during deceleration at occurrence of power failure and in a stop status after deceleration at occurrence of power failure.
- For the Y46 signal, set "46 (positive logic)" or "146 (negative logic)" in any of **Pr.190 to Pr.196 (Output terminal function selection)** to assign the function.

### ◆ Power failed (Y67) signal

- Y67 signal turns ON when the output is shut off due to detection of power failure (power supply fault) or undervoltage, or the power failure time deceleration-to-stop function is activated.
- To use the Y67 signal, assign the function by setting "67 (positive logic)" or "167 (negative logic)" in any of **Pr.190 to Pr.196 (Output terminal function selection)**.

## NOTE

- When **Pr.30 Regenerative function selection** = "2" and the FR-HC2, FR-XC (in common bus regeneration mode), or FR-CV is used, the deceleration stop function is invalid at power failure.
- If the "output frequency - **Pr.262**" at undervoltage or at power failure is a negative value, it is regarded as 0 Hz. (DC injection brake operation is performed without deceleration.)
- The power failure time deceleration stop function is disabled during a stop or when the breaker is tripped.
- The Y46 signal turns ON if an undervoltage occurs even if a deceleration at a power failure has not occurred. For this reason, the Y46 signal is sometimes output instantaneously when the power supply is turned OFF, but this is not a fault.
- When the power failure time deceleration-to-stop function is selected, undervoltage protection (E.UVT), instantaneous power failure protection (E.IPF) and input phase loss protection (E.ILF) are invalid.
- When the load is high during PM sensorless vector control, an undervoltage sometimes causes the coasting stop.
- To use the power failure time deceleration-to-stop function for the separated converter type, use a converter unit manufactured in August 2014 or later.
- Changing the terminal assignment using **Pr.178 to Pr.189 (Input terminal function selection)** and **Pr.190 to Pr.196 (Output terminal function selection)** may affect the other functions. Set parameters after confirming the function of each terminal.

## CAUTION

- Even if the power failure time deceleration-to-stop function is set, some loads might cause the inverter to trip and the motor to coast.  
The motor coasts if sufficient regenerative power is not obtained from the motor.

### Parameters referred to

**Pr.12 DC injection brake operation voltage** [page 715](#)

**Pr.20 Acceleration/deceleration reference frequency, Pr.21 Acceleration/deceleration time increments** [page 367](#)

**Pr.30 Regenerative function selection** [page 724](#)

**Pr.57 Restart coasting time** [page 628](#), [page 635](#)

**Pr.190 to Pr.196 (Output terminal function selection)** [page 473](#)

**Pr.872 Input phase loss protection selection** [page 426](#)

## 5.14.18 PLC function

The inverter can be run in accordance with a sequence program.

In accordance with the machine specifications, a user can set various operation patterns: inverter movements at signal inputs, signal outputs at particular inverter status, and monitor outputs, etc.

Pr.	Name	Initial value	Setting range	Description	
414 A800	PLC function operation selection	0	0	PLC function disabled	
			1, 11	PLC function enabled	The SQ signal is enabled by input from a command source (external input terminal/communication).
			2, 12		The SQ signal is enabled by input from an external input terminal.
415 A801	Inverter operation lock mode setting	0	0	The inverter start command is enabled regardless of the operating status of the sequence program.	
			1	The inverter start command is enabled only while the sequence program is running.	
416 A802	Pre-scale function selection	0	0 to 5	Unit scale factor 0: No function 1: ×1 2: ×0.1 3: ×0.01 4: ×0.001 5: ×0.0001	When the pulse train is input from terminal JOG, the number of sampling pulses can be converted. The result of conversion is stored to SD1236. Number of sampled pulses = Input pulse value per count cycle × Pre-scale setting value (Pr.417) × Unit scale factor (Pr.416)
417 A803	Pre-scale setting value	1	0 to 32767	Pre-scale setting value	
498 A804	PLC function flash memory clear	0	0, 9696 (0 to 9999)	0: Clears the flash memory fault display (no operation after writing while the flash memory is in normal operation).	Write
				9696: Clears the flash memory (no operation after writing while the flash memory is at a fault).	
				Other than 0 and 9696: Outside the setting range	
				0: Normal display	Read
				1: The flash memory is not cleared because the PLC function is enabled.	
9696: During flash memory clearing operation or flash memory fault					
675 A805	User parameter auto storage function selection	9999	1	Auto storage function enabled	
			9999	Auto storage function disabled	
1150 to 1199 A810 to A859	User parameters 1 to User parameters 50	0	0 to 65535	Desired values can be set. Because devices D206 to D255 used by the PLC function can be mutually accessed, the values set to Pr.1150 to Pr.1199 can be used by the sequence program. The result of performing calculation by a sequence program can also be monitored by Pr.1150 to Pr.1199.	

## ◆ Outline of PLC function

- To enable the PLC function, set a value other than "0" in **Pr.414 PLC function operation selection**. When "2 or 12" is set in **Pr.414**, the Sequence startup (SQ) signal from the external input terminal is valid regardless of the setting of the **Pr.338 Communication operation command source**. (The **Pr.414** setting change becomes valid after inverter reset.)
- Switch the execution key (RUN/STOP) of the sequence program by turning the SQ signal ON/OFF. The sequence program can be executed by turning the SQ signal ON. To input the SQ signal, set "50" in any of **Pr.178 to Pr.189 (Input terminal function selection)** to assign the function to a terminal.
- When "1" is set in **Pr.415 Inverter operation lock mode setting**, the inverter can be operated only when the sequence program is running. By changing the PLC program status from RUN to STOP during inverter operation, the motor decelerates to stop. To stop the inverter operation at the STOP status of the PLC program while performing auto operation using SD1148 (or SM1200 to 1211) of the PLC program, set **Pr.415** = "1".
- For reading or writing sequence programs, use FR Configurator2 on the personal computer connected to the inverter via RS-485 communication or USB. (When **Pr.414** ≠ "0", sequence programs can be read from or written to FR Configurator2.)
- The following shows the required conditions to enable the SQ signal.

Pr.414 setting	Pr.338 setting	SQ signal	
		Input via an external (physical) terminal	Input via a communication virtual terminal
1, 11	0	ON	ON
	1	ON	—
2, 12	—	ON	—

—: Not required to enable the SQ signal

## ◆ User parameter (data register (D)) auto storage function selection

- Setting **Pr.675** = "1" enables the auto storage function for user parameters.
- The user parameter auto storage function is used to store the setting of **Pr.1195 PLC function user parameters 46** (D251) to **Pr.1199 PLC function user parameters 50** (D255) automatically in EEPROM at power OFF or inverter reset.
- The auto storage function is disabled while the inverter performs any of the following.  
Measurement of the main circuit capacitor's life, offline auto tuning, or measurement of load characteristics

### NOTE

- The auto storage function may fail if the EEPROM is accessed by other functions at the same time at power OFF. To ensure the auto storage, provide a power source for the control circuit separately from that of the main circuit.

## ◆ User parameter reading from EEPROM

- User parameters (**Pr.1150 to Pr.1199**) are read from RAM or EEPROM according to the settings in **Pr.342 Communication EEPROM write selection** and **Pr.414 PLC function operation selection**. When **Pr.414** = "11 or 12", RAM data is read regardless of the **Pr.342** setting.

Device	Pr.342	Pr.414	Read from	Written to
Inverter (via communication), FR Configurator2	0	0, 1, 2	EEPROM	EEPROM
		11, 12	RAM	
	1	0, 1, 2	RAM	RAM
		11, 12	RAM	
Communication option	0	0, 1, 2	(Differs according to the option type.)	EEPROM
		11, 12	RAM	
	1	0, 1, 2	RAM	RAM
		11, 12	RAM	
Parameter unit Operation panel	0	0, 1, 2	EEPROM	EEPROM
		11, 12	RAM	
	1	0, 1, 2	EEPROM	RAM
		11, 12	RAM	

### NOTE

- For details on the PLC function, refer to the PLC Function Programming Manual and the Instruction Manual of FR Configurator2.

## ◆ Copying the PLC function project data to USB memory

- This function copies the PLC function project data to a USB memory device. The PLC function project data copied in the USB memory device can be copied to other inverters. This function is useful in backing up the parameter setting and for allowing multiple inverters to operate by the same sequence programs.
- Refer to [page 85](#) for an outline of the USB communication function.

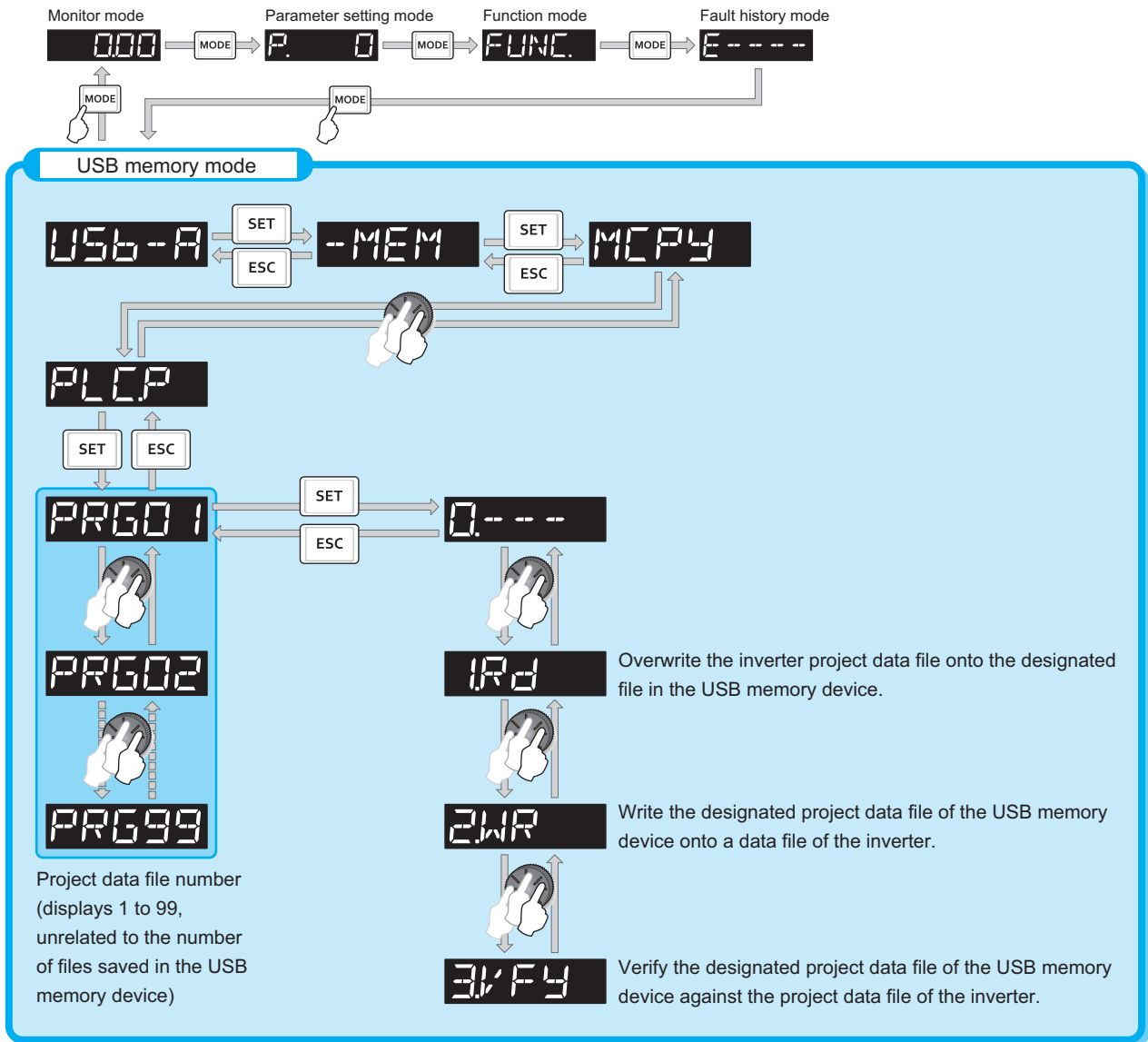

- The following data can be copied by copying the project data via USB memory device.

Extension	File type	Copy from inverter to USB memory device	Copy from USB memory device to inverter
.QPA	Parameter file	Supported	Supported
.QPG	Program file	Supported	Supported
.C32	Function block source information	Supported	Supported
.QCD	Global text comment information	Supported	Supported
.DAT	Project management information	Supported	Not available
.TXT	Copy information	Supported	Not available

**NOTE**

- If the project data of the PLC function is locked with a password using FR Configurator2, copying to the USB memory device and verification are disabled. Also if set to write-disabled, writing to the inverter is disabled. (For details on the PLC function, refer to the PLC Function Programming Manual and the Instruction Manual of FR Configurator2.)

Parameters referred to

Pr.338 Communication operation command source [page 400](#)

### 5.14.19 Trace function

- The operating status of the inverter can be traced and stored on a USB memory device.
- Stored data can be monitored by FR Configurator2, and the status of the inverter can be analyzed.

Pr.	Name	Initial value	Setting range	Description
1020 A900	Trace operation selection	0	0	Without trace operation (The read value is always "0".)
			1	Sampling start
			2	Forced trigger
			3	Sampling stop
			4	Transfer of data to USB memory device
1021 A901	Trace mode selection	0	0	Memory mode
			1	Memory mode (automatic transfer)
			2	Recorder mode
1022 A902	Sampling cycle	2	0 to 9	Set the sampling cycle. 0: approx. 0.125 ms, 1: approx. 0.25 ms, 2: 1 ms, 3: 2 ms, 4: 5 ms, 5: 10 ms, 6: 50 ms, 7: 100 ms, 8: 500 ms, 9: 1 s (For the setting values "0" and "1", the cycle varies according to the control mode.)
1023 A903	Number of analog channels	4	1 to 8	Select the number of analog channels for sampling.
1024 A904	Sampling auto start	0	0	Manual sampling start
			1	Sampling starts automatically when the power supply is turned ON or at a reset
1025 A905	Trigger mode selection	0	0	Fault trigger
			1	Analog trigger
			2	Digital trigger
			3	Analog or digital trigger (OR logic)
			4	Both analog and digital triggers (AND logic)
1026 A906	Number of sampling before trigger	90%	0 to 100%	Set the percentage of the pre-trigger sampling time with respect to the overall sampling time.
1027 A910	Analog source selection (1ch)	201	1 to 3, 5 to 14, 17 to 20, 22 to 24, 32 to 36, 39 to 42, 46, 52 to 54, 61, 62, 64, 67, 71 to 75, 87 to 98, 201 to 213, 222 to 227, 230 to 232, 235 to 238	Select the analog data (monitor item) for sampling on each channel.
1028 A911	Analog source selection (2ch)	202		
1029 A912	Analog source selection (3ch)	203		
1030 A913	Analog source selection (4ch)	204		
1031 A914	Analog source selection (5ch)	205		
1032 A915	Analog source selection (6ch)	206		
1033 A916	Analog source selection (7ch)	207		
1034 A917	Analog source selection (8ch)	208		
1035 A918	Analog trigger channel	1		
1036 A919	Analog trigger operation selection	0	0	Sampling starts when the value of the analog monitor exceeds the value set at the trigger level ( <b>Pr.1037</b> )
			1	Sampling starts when the value of the analog monitor falls below the value set at the trigger level ( <b>Pr.1037</b> )
1037 A920	Analog trigger level	1000	600 to 1400	Set the level at which the analog trigger turns ON. The trigger level is the value obtained by subtracting 1000 from the set value.

Pr.	Name	Initial value	Setting range	Description
1038 A930	Digital source selection (1ch)	1	1 to 255	Select the digital data (I/O signal) for sampling on each channel.
1039 A931	Digital source selection (2ch)	2		
1040 A932	Digital source selection (3ch)	3		
1041 A933	Digital source selection (4ch)	4		
1042 A934	Digital source selection (5ch)	5		
1043 A935	Digital source selection (6ch)	6		
1044 A936	Digital source selection (7ch)	7		
1045 A937	Digital source selection (8ch)	8		
1046 A938	Digital trigger channel	1	1 to 8	Select the digital channel to be the trigger.
1047 A939	Digital trigger operation selection	0	0	Tracing starts when the signal turns ON
			1	Tracing starts when the signal turns OFF

## ◆ Operation outline

- This function is used to sample the status data (analog monitor and digital monitor) of the inverter, trace the sampling data when a trigger (trace start condition) occurs, and stores the resulting trace data.
- When the trace function is set enabled, samplings are collected and the inverter goes into the pre-trigger status.
- In the pre-trigger status, samples are collected, and the trigger standby status is entered when sufficient samples for the number of pre-trigger samples have been collected.
- When a trigger occurs in the trigger standby status, tracing is started and the trace data is stored.

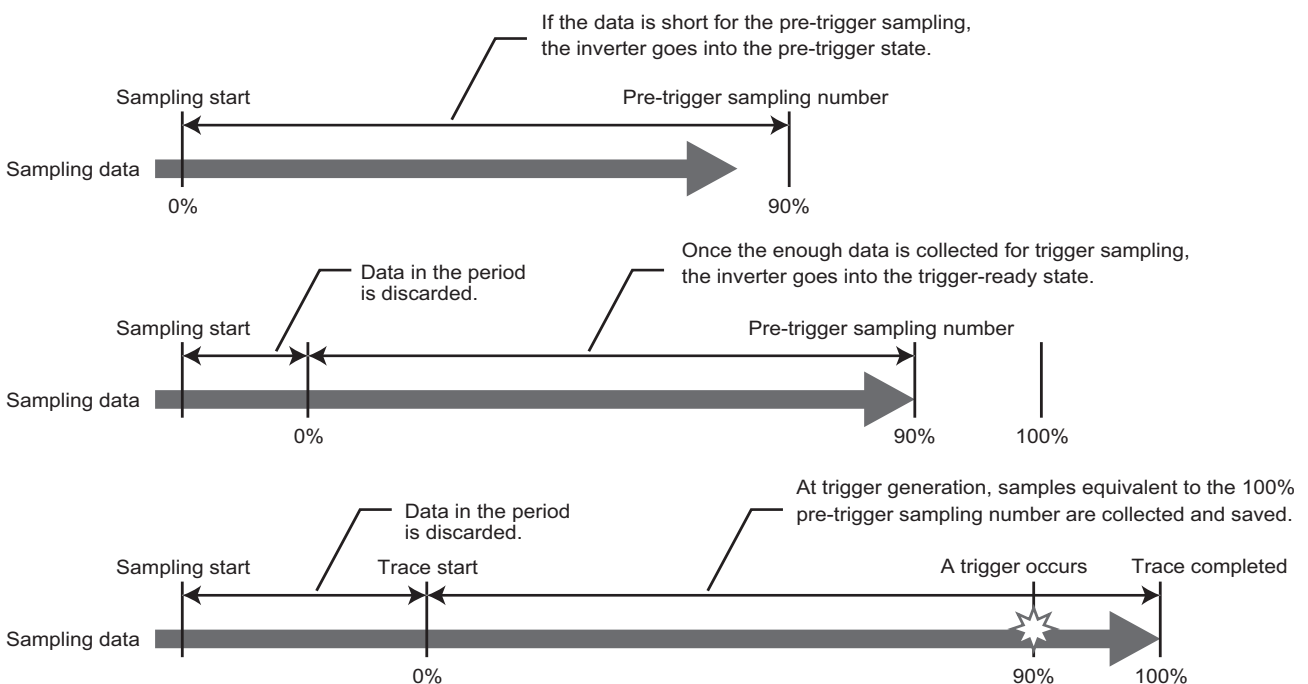

## ◆ Tracing procedure

### 1. Preparing a USB memory device

Select a USB memory device with ample capacity to store the necessary amount of trace data. When the trace function is used in the recorder mode, use a USB memory device with at least 1 GB of free space.



2. Prior setting for tracing  
Set **Pr.1021** to select a trace mode.  
Set **Pr.1022 Sampling cycle** and **Pr.1023 Number of analog channels** according to the necessary sampling time.  
Use **Pr.1027 to Pr.1034** to set analog sources, and **Pr.1038 to Pr.1045** to set digital sources.  
Set a trigger type in **Pr.1025**.
3. Tracing  
Set **Pr.1020 or Pr.1024** to start sampling or store trace data in the USB memory device.  
The trace status can be monitored. (Refer to [page 658](#).)
4. Waveform check  
By using FR Configurator2, trace data stored in a USB memory device can be displayed on a computer screen. For details, refer to the Instruction Manual of FR Configurator2.

## ◆ Selection of trace mode (Pr.1021)

- Select how to store the trace data which results from sampling the inverter status.
- There are two methods to store trace data, memory mode and recorder mode.

Pr.1021 setting	Mode	Description	Storing trace data
0	Memory mode	Trace data is stored sequentially to the internal RAM in the inverter.	To store trace data on a USB memory device, set <b>Pr.1020 Trace operation selection</b> = "4" after the sampling and tracing is completed. <sup>*1</sup>
1	Memory mode (automatic transfer)	Trace data is stored sequentially to the internal RAM in the inverter, and automatically transferred to the USB memory device.	Trace data is automatically stored on the USB memory device after tracing is completed.
2	Recorder mode	Trace data is stored directly on the USB memory device. Sampling data is fixed at 8 analog channels and 8 digital channels. The sampling cycle in this mode is longer than in the memory mode. (1 ms or longer)	To stop sampling and complete storing trace data after the sampling is started, set "2" (forced trigger) or "3" (sampling stop) in <b>Pr.1020 Trace operation selection</b> . <sup>*1</sup>

\*1 For details on **Pr.1020**, refer to [page 657](#).

### NOTE

- When the trace function is used in the recorder mode, use USB memory device having at least 1 GB of free space.
- Data transferred to the USB memory device is stored in the "TRC" folder under the "FR\_INV" folder.
- Up to 99 sets of trace data can be stored in the USB memory device in the memory mode. When a data set is transferred to the USB memory that contains 99 sets of data, its "MEM001.tr1" file will be overwritten. REC001.tr1 is the only data file stored in the recorder mode.
- The data sampled in the recorder mode will be corrupted by resetting or turning OFF the inverter during sampling.
- By using FR Configurator2, the trace data of the internal RAM can be directly transmitted to the personal computer via the USB cable. For details, refer to the Instruction Manual of FR Configurator2.

## ◆ Selection of sampling time (Pr.1022, Pr.1023)

- The sampling time is determined by the sampling cycle and the number of data acquisition points. The number of data acquisition points differs between the memory mode and the recorder mode.

### Memory mode

The sampling time varies depending on the setting in **Pr.1022 Sampling cycle** and **Pr.1023 Number of analog channels**.

Pr.1023 Number of analog channels	Memory mode sampling time		Number of data acquisition points
	Minimum (Pr.1022 = "0")	Maximum (Pr.1022 = "9")	
1	213 ms	1704 s	1704
2	160 ms	1280 s	1280
3	128 ms	1024 s	1024
4	106.5 ms	852 s	852
5	91 ms	728 s	728
6	80 ms	640 s	640
7	71 ms	568 s	568
8	64 ms	512 s	512

### Recorder mode

The sampling time varies depending on the setting in **Pr.1023 Number of analog channels**.

Analog channel number	Recorder mode sampling time		Number of data acquisition points
	Minimum (Pr.1022 = "2") <sup>*1</sup>	Maximum (Pr.1022 = "9")	
Fixed to 8ch (analog source selection)	Approx. 14 hours	Approx. 621 days	53687091

\*1 Sampling is performed at a sampling cycle of 1 ms even if "0 or 1" is set to **Pr.1022 Sampling cycle**.

## ◆ Analog source (monitor item) selection

- Select the analog sources (monitor items) to be set to Pr.1027 to Pr.1034 from the following table.

Setting value	Monitor item*1	Minus (-) display*2	Trigger level criterion*3	Setting	Monitor item*1	Minus (-) display*2	Trigger level criterion*3
1	Output frequency/speed		*4	74	Cumulative pulse overflow times (control terminal option)	○	*4
2	Output current		*4	75	Multi-revolution counter		65535
3	Output voltage		*4	87	Remote output value 1	○	*4
5	Frequency setting value/motor speed setting		*4	88	Remote output value 2	○	*4
6	Running speed		*4	89	Remote output value 3	○	*4
7	Motor torque		*4	90	Remote output value 4	○	*4
8	Converter output voltage		*4	91	PID manipulated amount	○	*4
9*5	Regenerative brake duty		*4	92	Second PID set point/deviation input selection		*4
10	Electronic thermal O/L relay load factor		*4	93	Second PID measured value		*4
11	Output current peak value		*4	94	Second PID deviation	○	*4
12	Converter output voltage peak value		*4	95	Second PID measured value 2		*4
13	Input power		*4	96	Second PID manipulated amount	○	*4
14	Output power		*4	97	Dancer main set speed		*4
17	Load meter		*4	98	Control circuit temperature	○	*4
18	Motor excitation current		*4	201	*Output frequency		<b>Pr.84</b>
19	Position pulse		65535	202	*U-phase output current	○	ND rated current
20	Cumulative energization time		65535	203	*V-phase output current	○	ND rated current
22	Orientation status		65535	204	*W-phase output current	○	ND rated current
23	Actual operation time		65535	205	Converter output voltage		400 V/800 V
24	Motor load factor		*4	206	*Output current (all three phases)		ND rated current
32	Torque command		*4	207	*Excitation current (A)		ND rated current
33	Torque current command		*4	208	*Torque current (A)		ND rated current
34	Motor output		*4	209	Terminal 2		100%
35	Feedback pulse		65535	210	Terminal 4		100%
36	Torque monitor (power driving/regenerative driving polarity switching)	○	*4	211	Terminal 1	○	100%
39	SSCNET III communication status*7		65535	212	*Excitation current (%)	○	100%
40	PLC function user monitor 1	○	*4	213	*Torque current (%)	○	100%
41	PLC function user monitor 2	○	*4	222	Position command		65535
42	PLC function user monitor 3	○	*4	223	Position command (upper digits)	○	65535
46	Motor temperature	○	*4	224	Current position		65535
52	PID set point		*4	225	Current position (upper digits)	○	65535
53	PID measured value		*4	226	Droop pulse		65535
54	PID deviation	○	*4	227	Droop pulse (upper digits)	○	65535
61	Motor thermal load factor		*4	230	*Output frequency (signed)	○	<b>Pr.84</b>
62	Inverter thermal load factor		*4	231	*Motor speed (with sign)	○	*6
64	PTC thermistor resistance		<b>Pr.561</b>	232	*Speed command (with sign)	○	*6
67	PID measured value 2		*4	235	*Torque command	○	100%
71	Cumulative pulse	○	*4	236	*Motor torque	○	100%

Setting value	Monitor item <sup>*1</sup>	Minus (-) display <sup>*2</sup>	Trigger level criterion <sup>*3</sup>	Setting	Monitor item <sup>*1</sup>	Minus (-) display <sup>*2</sup>	Trigger level criterion <sup>*3</sup>
72	Cumulative pulse overflow times	○	*4	237	*Excitation current command	○	100%
73	Cumulative pulse (control terminal option)	○	*4	238	*Torque current command	○	100%

\*1 "" shows a monitor item with a high-speed sampling cycle.

\*2 The monitor items with a circle (○) represents that its monitor value can be indicated with minus sign.

\*3 Indicates a criterion at 100% when the analog trigger is set.

\*4 Refer to the full-scale value of terminal FM/CA, or AM (page 458).

\*5 Monitoring is available only for standard models.

\*6 Rated motor frequency × 120 / number of motor poles

\*7 Inverter output voltage is displayed when the FR-A8NS is not installed.

## ◆ Digital source (monitor item) selection

- Select the digital sources (input/output signals) to be set to **Pr.1038 to Pr.1045** from the following table. When a value other than the ones in the following table is set, "0" (OFF) is applied for indication.

Setting value	Signal name	Remarks	
0	—	For details on the signals, refer to <a href="#">page 521</a> .	
1	STF		
2	STR		
3	AU		
4	RT		
5	RL		
6	RM		
7	RH		
8	JOG		
9	MRS		
10	STP (STOP)		
11	RES		
12	CS		
21	X0		For details on the signals, refer to the Instruction Manual of the FR-A8AX (option).
22	X1		
23	X2		
24	X3		
25	X4		
26	X5		
27	X6		
28	X7		
29	X8		
30	X9		
31	X10		
32	X11		
33	X12		
34	X13		
35	X14		
36	X15		
37	DY		

Setting value	Signal name	Remarks
101	RUN	For details on the signals, refer to <a href="#">page 473</a> .
102	SU	
103	IPF	
104	OL	
105	FU	
106	ABC1	
107	ABC2	For details on the signals, refer to the Instruction Manual of the FR-A8AY (option).
121	DO0	
122	DO1	
123	DO2	
124	DO3	
125	DO4	
126	DO5	For details on the signals, refer to the Instruction Manual of the FR-A8AR (option).
127	DO6	
128	RA1	
129	RA2	
130	RA3	

## ◆ Trigger setting (Pr.1025, Pr.1035 to Pr.1037, Pr.1046, Pr.1047)

- Set the trigger generating conditions and the trigger target channels.

Pr.1025 setting	Trigger generating conditions	Selection of trigger target channel
0	Tracing starts when inverter enters an fault status (protective function activated)	—
1	Tracing starts when analog monitor satisfies trigger conditions	<b>Pr.1035</b>
2	Tracing starts when digital monitor satisfies trigger conditions	<b>Pr.1046</b>
3	Tracing starts when either of analog or digital monitor satisfies trigger conditions (OR)	<b>Pr.1035, Pr.1046</b>
4	Tracing starts when both of analog or digital monitor satisfies trigger conditions (AND)	<b>Pr.1035, Pr.1046</b>

- Set the trigger generation conditions for the analog monitor.

Pr.1036 setting	Trigger generation conditions	Trigger level setting
0	Sampling starts when the analog data targeted for the trigger exceeds the value specified at the trigger level	Set the trigger level from 600 to 1400 (-400 to 400% <sup>*1</sup> ) in <b>Pr.1037</b> .
1	Sampling starts when the analog data targeted for the trigger falls below the value specified at the trigger level	

\*1 In **Pr.1037**, set the number obtained by adding 1,000 to the trigger level.

- Set the trigger generation conditions for the digital monitor.

Pr.1047 setting	Trigger generation conditions
0	Tracing starts when the digital data targeted for the trigger turns ON
1	Tracing starts when the digital data targeted for the trigger turns OFF

### ◆ Start of sampling and copying of data (Pr.1020, Pr.1024)

- Set the trace operation. The trace operation is set by one of two ways, by setting **Pr.1020 Trace operation selection** and by setting in the trace mode on the operation panel.
- When "1" is set in **Pr.1020**, sampling starts.
- When "2" is set in **Pr.1020**, it is regarded that a trigger occurs (forced trigger), and the sampling stops and the tracing starts.
- When "3" is set in **Pr.1020**, sampling stops.
- When "4" is set in **Pr.1020**, the trace data in internal RAM is transferred to USB memory device. (Trace data cannot be transferred during sampling.)
- To start sampling automatically when the power supply at power-ON or at a recovery after an inverter reset, set "1" in **Pr.1024 Sampling auto start**.

Pr.1020 setting	Trace mode	Operation
0	0----	Sampling standby
1	1RUN	Sampling start
2	2TRG	Forced trigger (sampling stop)
3	3END	Sampling stop
4	4CPY	Data transmission

- The read value of **Pr.1020** is always "0".
- Trace operation can also be set in the trace mode on the operation panel.

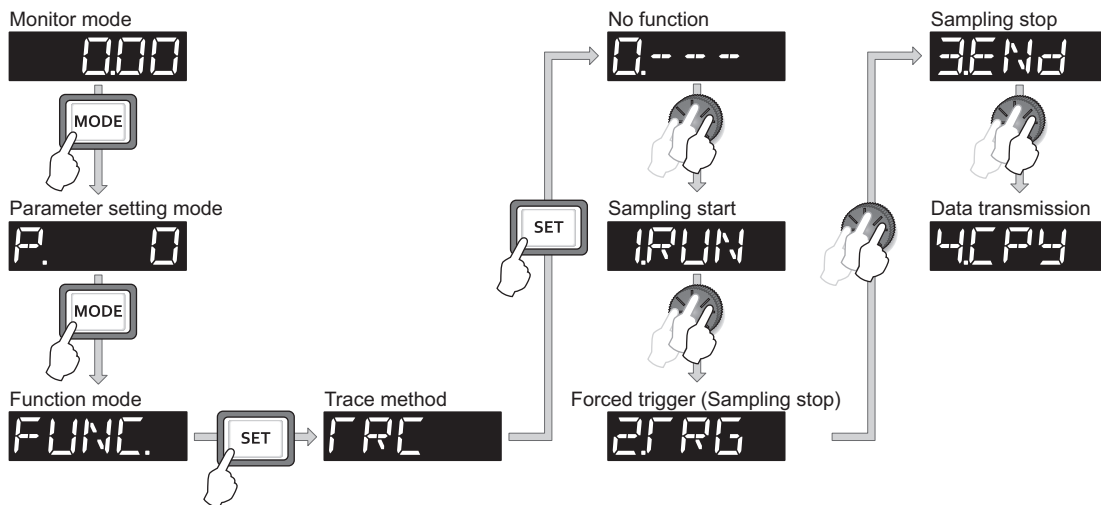

### ◆ Selection of trace operation by input terminal (TRG signal, TRC signal)

- Trace operation can be selected by signal inputs.
- A forced trigger can be applied when the Trace trigger input (TRG) signal is ON.
- Sampling is started and stopped by the Trace sampling start/end (TRC) signal turning ON and OFF, respectively.
- To input the TRG signal, set "46" in any of **Pr.178 to Pr.189 (Input terminal function selection)**, and to input the TRC signal, set "47" to assign the function to a terminal.

#### NOTE

- Changing the terminal assignment using **Pr.178 to Pr.189 (Input terminal function selection)** may affect the other functions. Set parameters after confirming the function of each terminal.

## ◆ Monitoring the trace status

- The trace status can be monitored on the operation panel by setting "38" in **Pr.52 Operation panel main monitor selection**, **Pr.774 to Pr.776 (Operation panel monitor selection)**, or **Pr.992 Operation panel setting dial push monitor selection**.

The content depends on the digits on the operation panel.

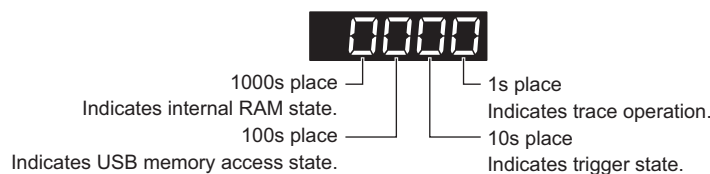

Monitor value	Trace status			
	Fourth digit	Third digit	Second digit	First digit
0 or no display <sup>*1</sup>	No trace data in internal RAM	USB memory not accessed	Trigger not detected	Tracing stopped
1	Trace data in internal RAM	USB memory being accessed	Trigger detected	Trace operation
2	—	USB memory transfer error	—	—
3	—	USB buffer overrun	—	—

\*1 The value(s) "0" to the left of the leftmost non-zero value is(are) not shown in the monitor display. For example, if no trace data is in internal RAM, the USB memory is not accessed, no trigger is detected, and the trace operation is performed, "1" appears. (not "0001")

- When copying the traced data to a USB memory device, the operating status of the USB host can be checked with the inverter LED.

Refer to [page 85](#) for an outline of the USB communication function.

LED display status	Operating status
OFF	No USB connection.
ON	The communication is established between the inverter and the USB device.
Blinking rapidly	Traced data is being transmitted. (In the memory mode, transmission command is being issued. In the recorder mode, sampling is being performed.)
Blinking slowly	Error in the USB connection.

- During trace operation, the Trace status (Y40) signal can be output.  
 To use the Y40 signal, set "40 (positive logic) or 140 (negative logic)" in one of **Pr.190 to Pr.196 (Output terminal function selection)** to assign function to an output terminal.

### NOTE

- Changing the terminal assignment using **Pr.190 to Pr.196 (Output terminal function selection)** may affect the other functions. Set parameters after confirming the function of each terminal.

### Parameters referred to

Pr.52 Operation panel main monitor selection [page 446](#)  
 Pr.178 to Pr.189 (Input terminal function selection) [page 521](#)  
 Pr.190 to Pr.196 (Output terminal function selection) [page 473](#)

# 5.15 (N) Communication operation parameters

Purpose	Parameter to set			Refer to page
To start operation via communication	Initial setting of operation via communication	P.N000, P.N001, P.N010 to P.N014	Pr.549, Pr.342, Pr.349, Pr.500 to Pr.502, Pr.779	663
To communicate via PU connector	Initial setting of computer link communication (PU connector)	P.N020 to P.N028	Pr.117 to Pr.124	670
To communicate via RS-485 terminals	Initial setting of computer link communication (RS-485 terminals)	P.N030 to P.N038	Pr.331 to Pr.337, Pr.341	
	MODBUS RTU communication specification	P.N002, P.N030, P.N031, P.N034, P.N080	Pr.539, Pr.331, Pr.332, Pr.334, Pr.343	686
To communicate via the CC-Link IE Field Network (FR-A800-GF)	CC-Link IE Field Network	P.N100 to P.N110, P.N111	Pr.434 to Pr.435, Pr.541	699
To Communicate using USB (FR Configurator2)	USB communication	P.N040, P.N041	Pr.547, Pr.548	701
To connect a GOT	GOT automatic recognition	P.N020, P.N030	Pr.117, Pr.331	701
To back up the data of parameter settings and PLC function to the GOT	Backup/restore	P.N110, P.N111	Pr.434, Pr.435	702

## 5.15.1 Wiring and configuration of PU connector

Using the PU connector as a computer network port enables communication operation from a personal computer, etc. When the PU connector is connected with a personal, FA, or other computer by a communication cable, a user program can run and monitor the inverter or read and write to parameters.

### ◆ PU connector pin-outs

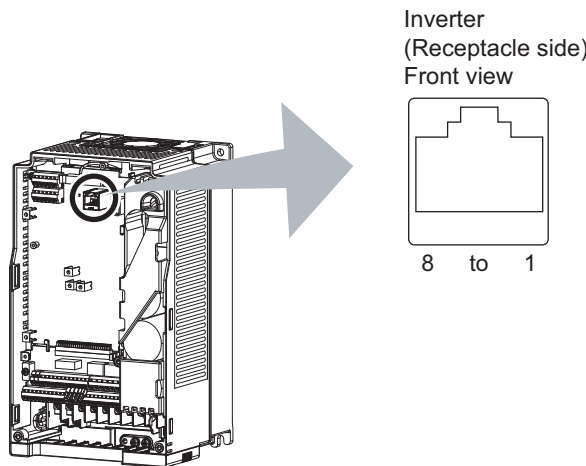

Pin number	Name	Description
1	SG	Earth (ground) (connected to terminal 5)
2	—	Operation panel power supply
3	RDA	Inverter receive+
4	SDB	Inverter send-
5	SDA	Inverter send+
6	RDB	Inverter receive-
7	SG	Earth (ground) (connected to terminal 5)
8	—	Operation panel power supply



**NOTE**

- Pins No. 2 and 8 provide power to the operation panel or parameter unit. Do not use these pins for RS-485 communication.
- Do not connect the PU connector to the computer's LAN board, FAX modem socket, or telephone modular connector. The product could be damaged due to differences in electrical specifications.

## ◆ Wiring and configuration of PU connector communication system

- System configuration

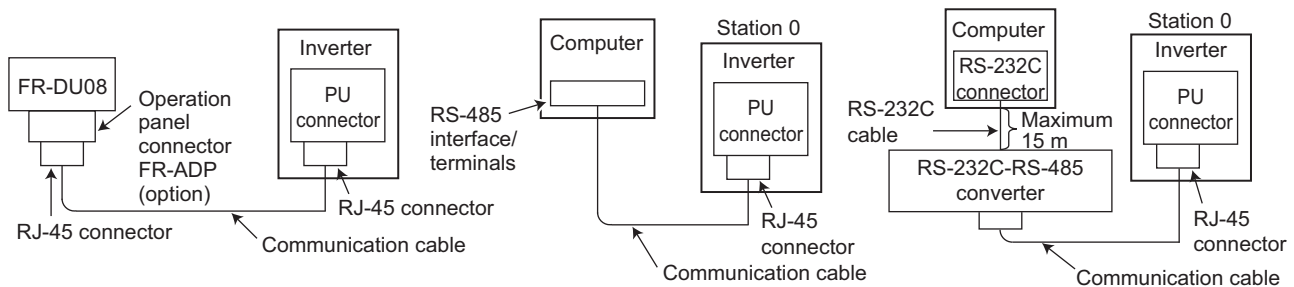

- Wiring between a computer and an inverter for RS-485 communication

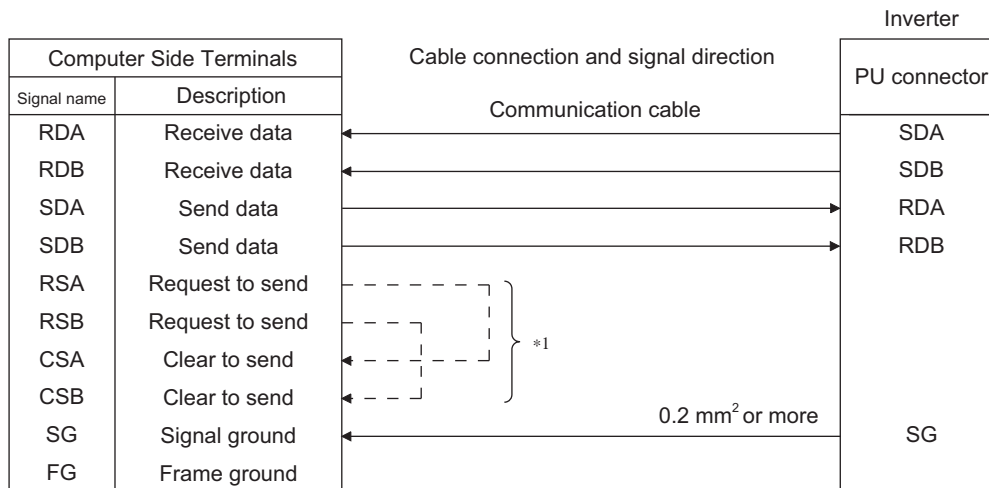

\*1 Make connection in accordance with the Instruction Manual of the computer to be used with. Fully check the terminal numbers of the computer since they vary with the model.

**NOTE**

- When performing RS-485 communication with multiple inverters, use the RS-485 terminals. (Refer to page 662.)
- Computer-inverter connection cable  
Refer to the following for the connection cable (RS-232C to RS-485 converter) between the computer with an RS-232C interface and an inverter. Commercially available products (as of October 2020)

Model	Manufacturer
Interface embedded cable DAFXIH-CAB (D-SUB25P for personal computer) DAFXIH-CABV (D-SUB9P for personal computer) +	Diatrend Corp.
Connector conversion cable DINV-485CAB (for inverter)*2	
Interface embedded cable dedicated for inverter DINV-CABV*2	

\*2 The conversion cable cannot connect multiple inverters. (The computer and inverter are connected in a 1:1 pair.) This is an RS232C-to-RS485 converter-embedded conversion cable. No additional cable or connector is required. For the product details, contact the manufacturer.

- Use Ethernet cables compliant with the following standards when fabricating the cable.

Ethernet cable	Connector	Type
Category 5e or higher straight cable (double shielded / STP)*3	RJ-45 connector	The following conditioning cables: • IEEE 802.3 (1000BASE-T) • ANSI/TIA/EIA-568-B (Category 5e)

## 5.15.2 Wiring and configuration of RS-485 terminals

### ◆ RS-485 terminal layout

**Terminating resistor switch**  
Initially-set to "OPEN".  
Set only the terminating resistor switch of the remotest inverter to the "100Ω" position.

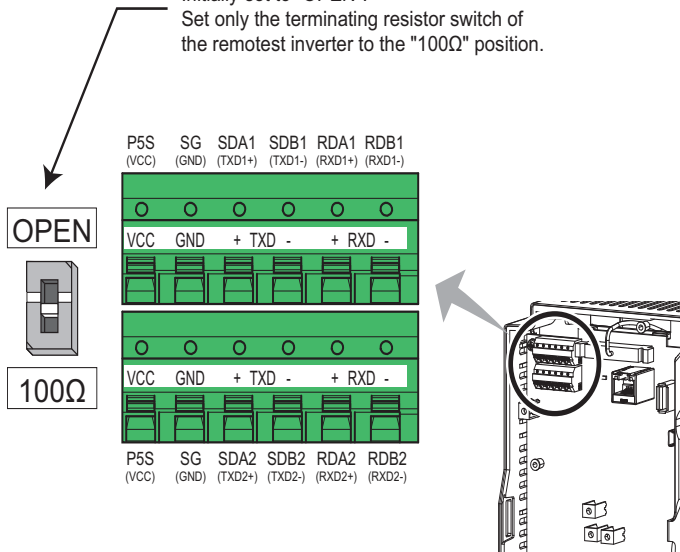

Name	Description
RDA1 (RXD1+)	Inverter receive+
RDB1 (RXD1-)	Inverter receive-
RDA2 (RXD2+)	Inverter receive + (for branch)
RDB2 (RXD2-)	Inverter receive - (for branch)
SDA1 (TXD1+)	Inverter send+
SDB1 (TXD1-)	Inverter send-
SDA2 (TXD2+)	Inverter send + (for branch)
SDB2 (TXD2-)	Inverter send - (for branch)
P5S (VCC)	5 V (permissible load current 100 mA)
SG (GND)	Earthing (grounding) (connected to terminal SD)

### ◆ Connection of RS-485 terminals and wires

- The size of RS-485 terminal block is the same as that of the control circuit terminal block. Refer to [page 74](#) for the wiring method.

#### NOTE

- To avoid malfunction, keep the RS-485 terminal wires away from the control circuit board.
- When the FR-A820-01250(22K) or lower, or the FR-A840-00620(22K) or lower is used with a plug-in option, lead the wires through the hole on the side face of the front cover for wiring of the RS-485 terminals.

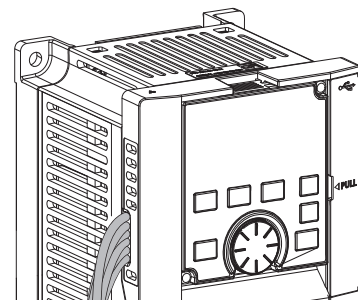
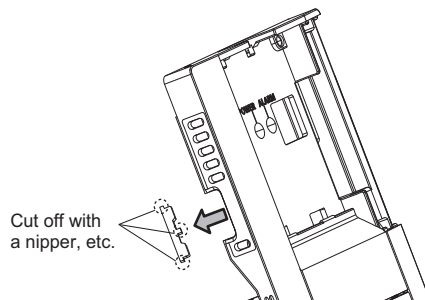

- When the FR-A820-01540(30K) or higher, or the FR-A840-00770(30K) or higher is used with a plug-in option, lead the wires on the left side of the plug-in option for wiring of the RS-485 terminals.

## ◆ System configuration of RS-485 terminals

- Computer and inverter connection (1:1)

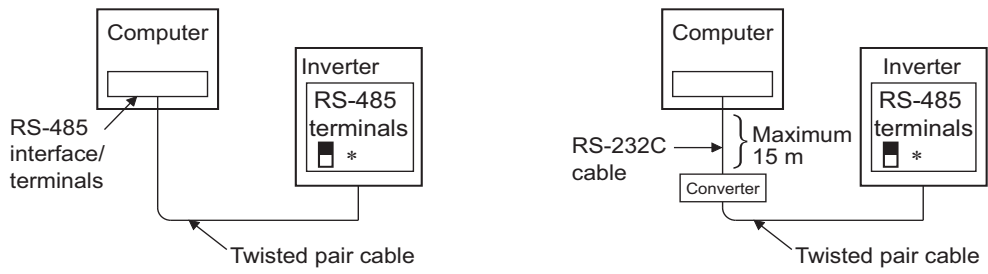

\*Set the terminating resistor switch to the "100Ω" position.

- Combination of a computer and multiple inverters (1:n)

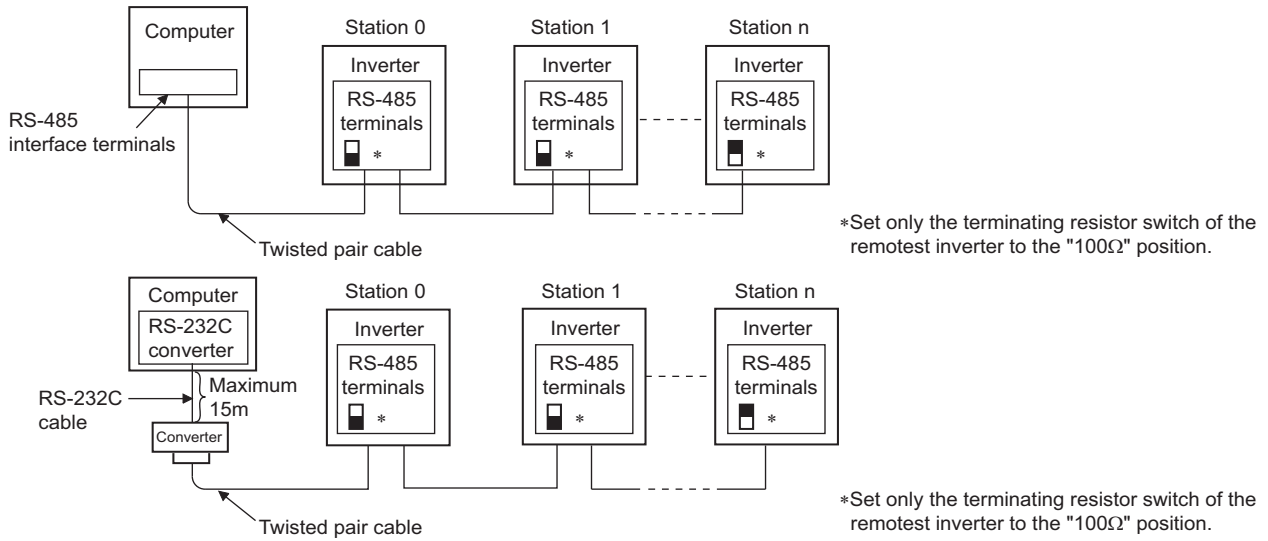

\*Set only the terminating resistor switch of the remotest inverter to the "100Ω" position.

\*Set only the terminating resistor switch of the remotest inverter to the "100Ω" position.

## ◆ RS-485 terminal wiring method

- Wiring between a computer and an inverter for RS-485 communications

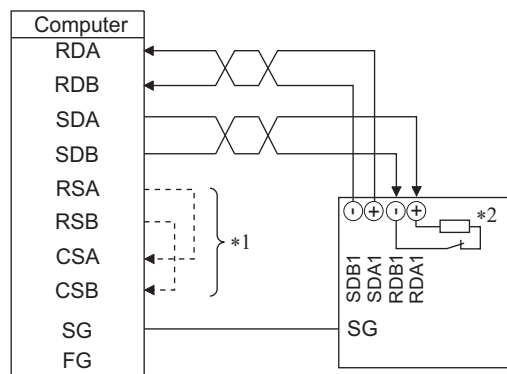

- Wiring between a computer and multiple inverters for RS-485 communication

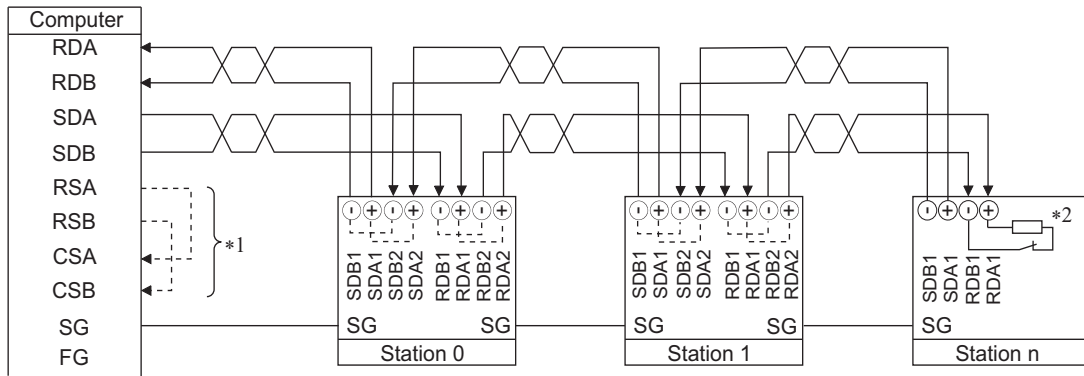

- \*1 Make connection in accordance with the Instruction Manual of the computer to be used with. Fully check the terminal numbers of the computer since they vary with the model.
- \*2 On the inverter most remotely connected with the computer, set the terminating resistor switch in the ON (100 Ω) position.

**NOTE**

- To connect the terminals in series, refer to the following.

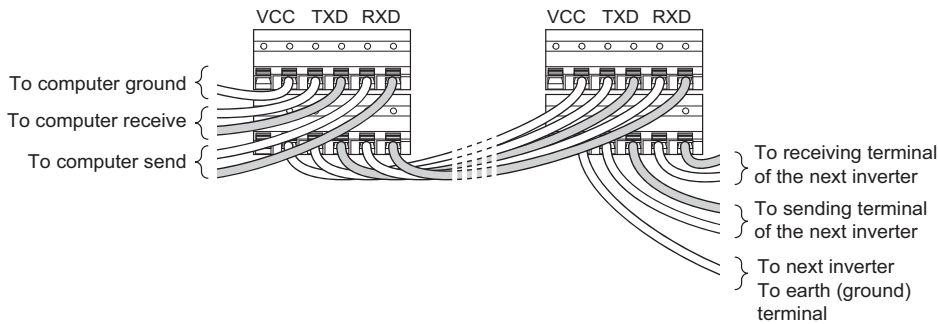

- To connect multiple inverters using RS-485 distributors, refer to the following. Commercially available products (as of October 2020)

Product name	Model	Manufacturer
RS-485 distributor	BMJ-8-28N (Pins No. 2 and No. 8 are not connected internally.) (A plug with a terminating resistor is not used.)	HACHIKO ELECTRIC CO., LTD.
	DMDH-3PN (Pins No. 2 and No. 8 are not connected internally.)	Diatrend Corp.
	DMDH-10PN (Pins No. 2 and No. 8 are not connected internally.)	

**◆ Two-wire type connection**

- If the computer is 2-wire type, a connection from the inverter can be changed to 2-wire type by passing wires across reception terminals and transmission terminals of the RS-485 terminals.

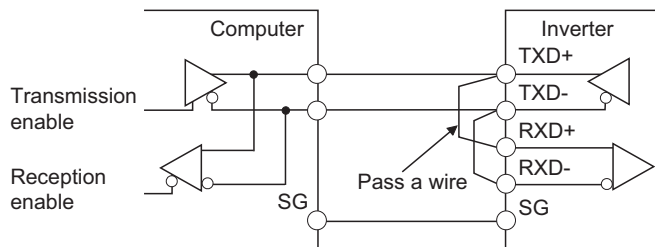

**NOTE**

- A program should be created so that transmission is disabled (receiving state) when the computer is not sending and reception is disabled (sending state) during sending to prevent the computer from receiving its own data.

**5.15.3 Initial setting of operation via communication**

Set the action when the inverter is performing operation via communication.

- Set the RS-485 communication protocol. (Mitsubishi inverter protocol / MODBUS RTU protocol)
- Set the action at fault occurrence or at writing of parameters.

Pr.	Name	Initial value	Setting range	Description
549 N000	Protocol selection	0	0	Mitsubishi inverter protocol (computer link)
			1	MODBUS RTU protocol
342 N001	Communication EEPROM write selection	0	0	Parameter values written by communication are written to the EEPROM and RAM.
			1	Parameter values written by communication are written to the RAM.
349 <sup>*1</sup>	Communication reset selection/Ready bit status selection	0	0	Enables the error reset function in any operation mode.
			1	Enables the error reset function only in the Network operation mode.
			100, 101	For details, refer to <a href="#">page 895</a> and <a href="#">page 897</a> .
			1000, 1001, 1100, 1101, 10000, 10001, 10100, 10101, 11000, 11001, 11100, 11101	For details, refer to <a href="#">page 893</a> .
N010 <sup>*1</sup>	Communication reset selection	0	0	Enables the error reset function in any operation mode.
			1	Enables the error reset function only in the Network operation mode.
N240 <sup>*1</sup>	Ready bit status selection	0	0	The status of Ready bit in communication data can be changed when an HMS network option is installed.
			1	
500 N011 <sup>*1</sup>	Communication error execution waiting time	0	0 to 999.8 s	Set the time from when the communication line error occurs until the inverter starts the operation for the communication error (when a communication option is used).
501 N012 <sup>*1</sup>	Communication error occurrence count display	0	0	Displays the communication error occurrence count (when a communication option is used).
502 N013	Stop mode selection at communication error	0	0 to 4, 11, 12	Select the operation at a communication error occurrence.
779 N014	Operation frequency during communication error	9999	0 to 590 Hz	Set the frequency for the operation when a communication error occurs.
			9999	Operation continues at the same frequency before the communication error.

\*1 The setting is available only when a communication option is installed.

\*2 If in communication by the communication option, "E.OP1" is displayed.

## ◆ Setting the communication protocol (Pr.549)

- Select the RS-485 communication protocol.
- The MODBUS RTU protocol can be used by communication from the RS-485 terminals.

Pr.549 setting	Communication protocol
0 (initial value)	Mitsubishi inverter protocol (computer link)
1	MODBUS RTU protocol

## ◆ Communication EEPROM write selection (Pr.342)

- When parameter write is performed via the inverter PU connector, RS-485 terminal, USB communication, or a communication option, the parameters storage device can be changed to "RAM only" from "EEPROM and RAM". Use this function if parameter settings are changed frequently.
- When changing the parameter values frequently, set "1" in **Pr.342 Communication EEPROM write selection** to write them to the RAM only. The life of the EEPROM will be shorter if parameter write is performed frequently with the setting unchanged from "0 (initial value)" (EEPROM write).

### NOTE

- Turning OFF the inverter's power supply clears the modified parameter settings when **Pr.342** = "1 (write only to RAM)". Therefore, the parameter values at next power-ON are the values last stored in EEPROM.
- The parameter setting written in RAM cannot be checked on the operation panel. (The values displayed on the operation panel are the ones stored in EEPROM.)

## ◆ Operation selection at a communication error (Pr.502, Pr.779)

- For communication using RS-485 terminals or a communication option, operation at a communication error can be selected. The operation is active under the Network operation mode.

- Select the stop operation at the retry count excess (**Pr.335**, enabled only when the Mitsubishi inverter protocol is selected) or at a signal loss detection (**Pr.336**, **Pr.539**).

Fault type	Pr.502 setting	At fault occurrence			At fault removal		
		Operation	Indication	Fault (ALM) signal	Operation	Indication	Fault (ALM) signal
Communication line	0 (initial value)	Output shutoff	E. SER <sup>*1</sup>	ON	Output stop status continues.	E. SER <sup>*1</sup>	ON
	1, 11	Output to decelerate and stop the motor.	"E.SER" indication after stop <sup>*1</sup>	ON after stop	Restart <sup>*3</sup>	Normal	OFF
	2, 12			OFF			
	3	Operation continues at the frequency set in <b>Pr.779</b> . <sup>*2</sup>	Normal	OFF	Normal	Normal	OFF
4	"CF" warning						
Communication option (when a communication option is used)	0, 3	Output shutoff	"E. 1"	ON	Output stop status continues.	"E. 1"	ON
	1, 2, 11, 12	Output to decelerate and stop the motor.	"E. 1" after stop	ON after stop			
	4	Operation continues at the frequency set in <b>Pr.779</b> . <sup>*2</sup>	"CF" warning	OFF	Operation continues at the frequency set in <b>Pr.779</b> .	"CF" warning	OFF

\*1 If in communication by the communication option, "E.OP1" is displayed.

\*2 Under position control, the operation is continued to the target position.

\*3 When the communication error is removed during deceleration, the motor re-accelerates. Under position control, the motor does not re-accelerate even when the communication error is removed during deceleration.

- The motor is decelerated to a stop according to the setting of **Pr.111 Third deceleration time** when an error occurs while **Pr.502 = "11 or 12"**.

Pr.502 setting	Operation to a stop at a communication error occurrence
0	Output shutoff
1 to 4	Deceleration stop according to the selected deceleration time (selectable using the RT or X9 signal)
11, 12	Deceleration stop according to the setting of <b>Pr.111</b>

- When a communication error is detected while communication with the RS-485 terminals is performed, the Alarm (LF) signal is output to an output terminal of the inverter. To use the LF signal, set "98 (positive logic) or 198 (negative logic)" in any of **Pr.190 to Pr.196 (Output terminal function selection)** to assign the function to the output terminal. (To output the LF signal even if communication through RS-485 terminals is not performed for the time set in **Pr.336** or longer, or during communication using a communication option, set "3 or 4" in **Pr.502**.)

- The following charts show operations when a communication line error occurs.

**Pr.502 = "0"** (initial value)

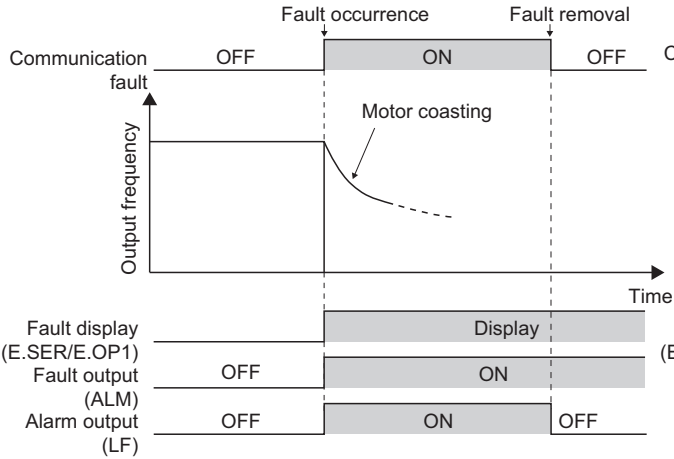

**Pr.502 = "1"**

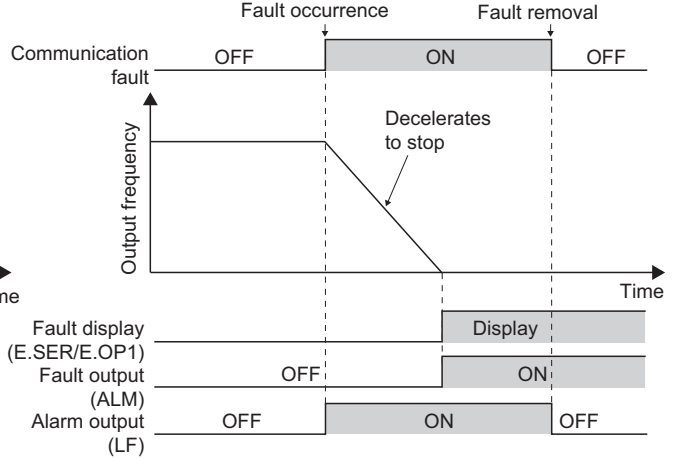

**Pr.502 = "2"**

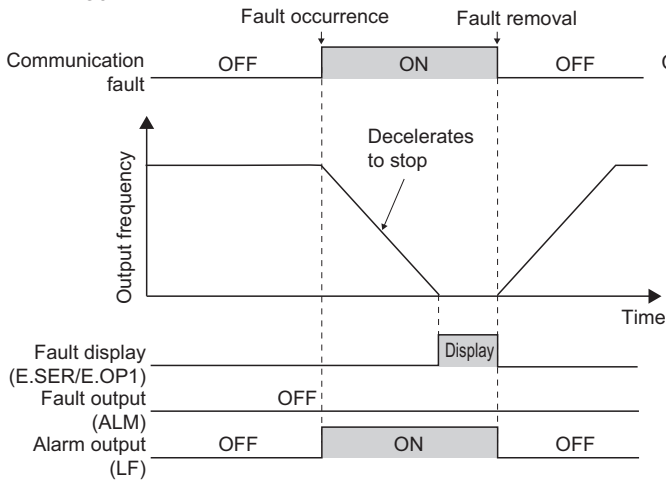

**Pr.502 = "3"**

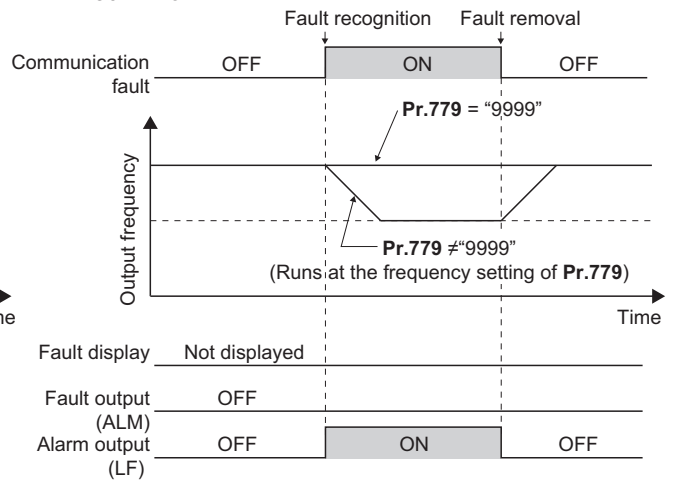

**Pr.502 = "4"**

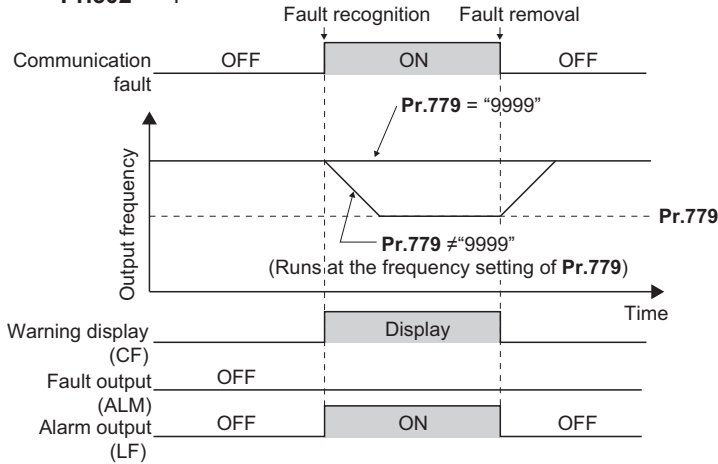

- The following charts show operations when a communication option fault occurs.

**Pr.502 = "0 (initial value) or 3"**

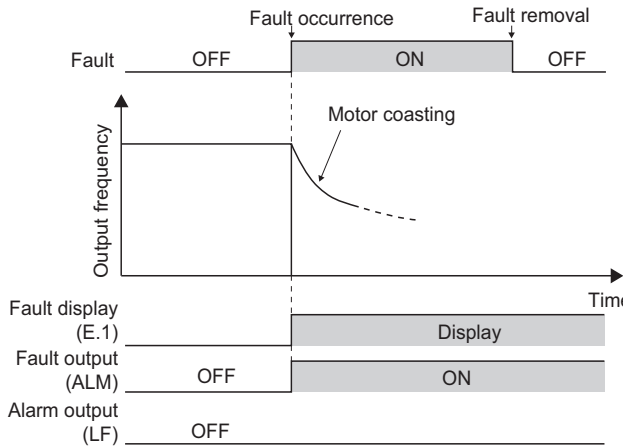

**Pr.502 = "1 or 2"**

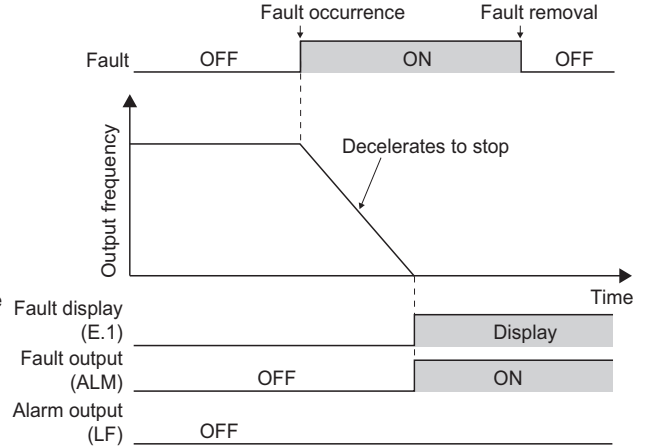

**Pr.502 = "4"**

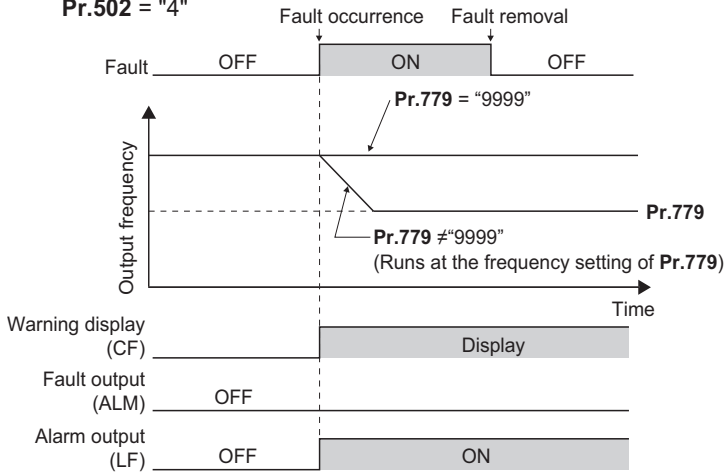



**NOTE**

- When a communication option is used, the protective function [E.OP1 (fault data: HA1)] is activated at error occurrences on the communication line. The protective function [E.1 (fault data: HF1)] is activated at error occurrences in the communication circuit inside the option.
- Fault output indicates the Fault (ALM) signal and an alarm bit output.
- When the fault output is set enabled, fault records are stored in the fault history. (A fault record is written to the fault history at a fault output.)
- When the fault output is not enabled, a fault record is overwritten to the fault history temporarily but not stored.
- After the fault is removed, the fault indication goes back to normal indication on the monitor, and the fault history goes back to the previous status.
- When **Pr.502** ≠ "0", the normal deceleration time setting (settings like **Pr.8**, **Pr.44**, and **Pr.45**) is applied as the deceleration time. Normal acceleration time setting (settings like **Pr.7** and **Pr.44**) is applied as the acceleration time for restart.
- When **Pr.502** = "2, 3, or 4", the inverter operates with the start command and the speed command, which were used before the fault.
- If a communication line error occurs, then the error is removed during deceleration while **Pr.502** = "2", the motor re-accelerates from that point. (When a communication option is used, acceleration does not restart at a communication option error.)
- The **Pr.502** and **Pr.779** settings are valid when communication is performed via the RS-485 terminals or a communication option.
- These parameters are valid under the Network operation mode. When performing communication through RS-485 terminals, set **Pr.551 PU mode operation command source selection** ≠ "1".
- **Pr.502** is valid for the device that has the command source under the Network operation mode. If a communication option is installed while **Pr.550** = "9999 (initial setting)", a communication error in RS-485 terminals occurs and **Pr.502** becomes invalid.
- If the communication error setting is disabled with **Pr.335** = "9999" or **Pr.539** = "9999" while **Pr.502** = "3 or 4", the inverter does not operate with the frequency set in **Pr.779** when a communication error occurs.
- If a communication error occurs while continuous operation at **Pr.779** is selected with **Pr.502** = "3 or 4", the inverter operates at the frequency set in **Pr.779** even though the speed command source is at the external terminals.  
Example) If a communication error occurs while **Pr.339** = "2" and the RL signal is input through an external terminal, the operation is continued at the frequency set in **Pr.779**.
- During position control, an error occurs even if "2" is set in **Pr.502**.

**CAUTION**

- When **Pr.502** = "3" and a communication line error occurs, or **Pr.502** = "4" and a communication line error or a communication option fault occurs, the operation continues. When setting "3 or 4" in **Pr.502**, provide a safety stop countermeasure other than via communication. For example, input a signal through an external terminal (RES, MRS, or X92) or press the PU stop on the operation panel.

**◆ Waiting time setting from the communication line error occurrence to the communication error activation (Pr.500)**

- When a communication option is used, use **Pr.500 Communication error execution waiting time** to set the time from when the communication line error occurs until the inverter starts the operation for the communication error.
- When a communication line error occurs and lasts longer than the time set in **Pr.500**, it is recognized as a communication error. If the communication returns to normal within the time, it is not recognized as a communication error, and the operation continues.

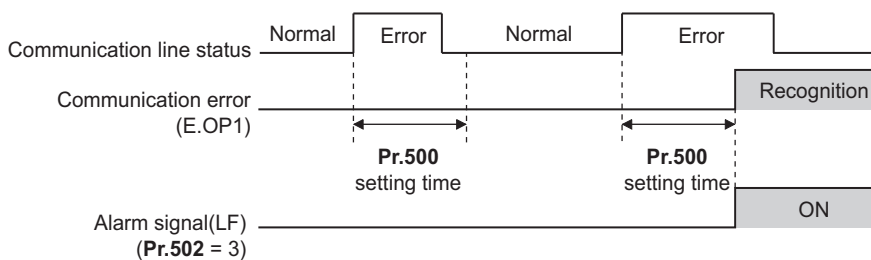



**NOTE**

- The changed value in **Pr.340** is applied after the next power-ON or inverter reset.
- The **Pr.340** setting can be changed on the operation panel in any operation mode.
- When setting a value other than "0" in **Pr.340**, make sure that the communication settings of the inverter are correct.

**Parameters referred to**

Pr.7 Acceleration time, Pr.8 Deceleration time, Pr.111 Third deceleration time [page 367](#)

Pr.79 Operation mode selection [page 389](#)

Pr.340 Communication startup mode selection [page 398](#)

Pr.335 RS-485 communication retry count [page 670](#)

Pr.336 RS-485 communication check time interval [page 670](#)

Pr.539 MODBUS RTU communication check time interval [page 686](#)

Pr.550 NET mode operation command source selection [page 400](#)

Pr.551 PU mode operation command source selection [page 400](#)

## 5.15.4 Initial settings and specifications of RS-485 communication

Use the following parameters to perform required settings for RS-485 communication between the inverter and a personal computer.

- Use the PU connector on the inverter or RS-485 terminals as communication interface.
- Parameter setting, monitoring, etc. can be performed using Mitsubishi inverter protocol or MODBUS RTU communication protocol.
- To make communication between the personal computer and inverter, setting of the communication specifications must be made to the inverter in advance. Data communication cannot be made if the initial settings are not made or if there is any setting error.

## ◆ Parameters related to PU connector communication

Pr.	Name	Initial value	Setting range	Description	
117 N020	PU communication station number	0	0 to 31	Use this parameter to specify the inverter station number. Enter the inverter station numbers when two or more inverters are connected to one personal computer.	
118 N021	PU communication speed	192	48, 96, 192, 384, 576, 768, 1152	Select the communication speed. The setting value × 100 equals the communication speed. For example, enter 192 to set the communication speed of 19200 bps.	
N022	PU communication data length	0	0 1	Data length 8 bits Data length 7 bits	
N023	PU communication stop bit length	1	0 1	Stop bit length 1 bit Stop bit length 2 bits	
119	PU communication stop bit length / data length	1	0	Stop bit length 1 bit	Data length 8 bits
			1	Stop bit length 2 bits	
			10	Stop bit length 1 bit	Data length 7 bits
			11	Stop bit length 2 bits	
120 N024	PU communication parity check	2	0	Parity check disabled.	
			1	Parity check (odd parity) enabled.	
			2	Parity check (even parity) enabled.	
121 N025	PU communication retry count	1	0 to 10	Set the permissible number of retries for unsuccessful data reception. If the number of consecutive errors exceeds the permissible value, the inverter output will be stopped.	
			9999	The inverter output will not be shut off even when a communication error occurs.	
122 N026	PU communication check time interval	9999	0	PU connector communication is disabled.	
			0.1 to 999.8 s	Set the interval of the communication check (Signal loss detection) time. If a no-communication state persists for longer than the permissible time, the inverter output will be shut off.	
			9999	No communication check (Signal loss detection)	
123 N027	PU communication waiting time setting	9999	0 to 150 ms	Set the time delay between data transmission to the converter and the response.	
			9999	The time delay is not set in this parameter but in communication data. Delay time: Number set in the data × 10 ms	
124 N028	PU communication CR/LF selection	1	0	Without CR/LF	
			1	With CR	
			2	With CR/LF	

## ◆ Parameters related to RS-485 terminal communication

Pr.	Name	Initial value	Setting range	Description
331 N030	RS-485 communication station number	0	0 to 31 (0 to 247) <sup>*1*2</sup>	Enter the station number of the inverter. (Same specifications as Pr.117)
332 N031	RS-485 communication speed	96	3, 6, 12, 24, 48, 96, 192, 384, 576, 768, 1152	Select the communication speed. (Same specifications as Pr.118)
N032	RS-485 communication data length	0	0, 1	Select the data length. (Same specifications as P.N022) <sup>*3</sup>
N033	RS-485 communication stop bit length	1	0, 1	Select the stop bit length. (Same specifications as P.N023) <sup>*4</sup>
333	RS-485 communication stop bit length / data length	1	0, 1, 10, 11	Select the stop bit length and data bit length. (Same specifications as Pr.119) <sup>*3*4</sup>
334 N034	RS-485 communication parity check selection	2	0, 1, 2	Select the parity check specifications. (Same specifications as Pr.120)
335 N035 <sup>*5</sup>	RS-485 communication retry count	1	0 to 10, 9999	Set the permissible number of retries for unsuccessful data reception. (Same specifications as Pr.121)
336 N036 <sup>*5</sup>	RS-485 communication check time interval	0 s	0	RS-485 communication is available, but the inverter trips in the NET operation mode.
			0.1 to 999.8 s	Set the interval of the communication check (Signal loss detection) time. (Same specifications as Pr.122)
			9999	No communication check (Signal loss detection)
337 N037 <sup>*5</sup>	RS-485 communication waiting time setting	9999	0 to 150 ms, 9999	Set the waiting time between data transmission to the inverter and the response. (Same specifications as Pr.123)
341 N038 <sup>*5</sup>	RS-485 communication CR/LF selection	1	0, 1, 2	Select the presence/absence of CR/LF. (Same specifications as Pr.124)

\*1 When "1" (MODBUS RTU protocol) is set in Pr.549, the setting range within parentheses is applied.

\*2 When a value outside the setting range is set, the inverter operates at the initial value.

\*3 In the MODBUS RTU protocol, the data length is fixed at 8 bits.

\*4 In the MODBUS RTU protocol, Pr.334 setting is applied as the stop bit length. (Refer to page 686.)

\*5 In the MODBUS RTU protocol, this is invalid.

### NOTE

- The monitor items and parameter settings can be read during communication with the **Pr.336 RS-485 communication check time interval** = "0 (initial value)" setting, but such operation will become faulty once the operation mode is changed to the NET operation mode. When the NET operation mode is selected as the start-up operation mode, communication is performed once, then a Communication fault (inverter) (E.SER) occurs. To perform operation or parameter writing via communication, set "9999" or a large setting value in Pr.336. (The setting value is determined by the computer program.) (Refer to page 678.)
- Always reset the inverter after making the initial settings of the parameters. After changing the communication-related parameters, communication cannot be made until the inverter is reset.

## 5.15.5 Mitsubishi inverter protocol (computer link communication)

Parameter setting and monitoring, etc. are possible by using the Mitsubishi inverter protocol (computer link communication) via inverter PU connector and the RS-485 terminals.

## ◆ Communication specifications

- The communication specifications are shown in the following table.

Item		Description	Related parameter
Communication protocol		Mitsubishi inverter protocol (computer link communication)	Pr.551
Conforming standard		EIA-485 (RS-485)	—
Number of connectable units		1: N (maximum 32 units), the setting range of station number is 0 to 31.	Pr.117 Pr.331
Communication speed	PU connector	Selected among 4800/9600/19200/38400/57600/76800/115200 bps.	Pr.118
	RS-485 terminals	Selected among 300/600/1200/2400/4800/9600/19200/38400/57600/76800/115200 bps.	Pr.332
Control procedure		Asynchronous method	—
Communication method		Half-duplex system	—
Communication specifications	Character system	ASCII (7 bits or 8 bits can be selected.)	Pr.119 Pr.333
	Start bit	1 bit	—
	Stop bit length	1 bit or 2 bits can be selected.	Pr.119 Pr.333
	Parity check	Check (at even or odd numbers) or no check can be selected.	Pr.120 Pr.334
	Error check	Sum code check	—
	Terminator	CR/LF (whether or not to use it can be selected)	Pr.124 Pr.341
Time delay setting		Availability of the setting is selectable.	Pr.123 Pr.337

## ◆ Communication procedure

- Data communication between the computer and inverter is made in the following procedure.
  - Request data is sent from the computer to the inverter. (The inverter will not send data unless requested.)
  - Communication waiting time
  - The inverter sends reply data to the computer in response to the computer request.
  - Inverter data processing time
  - An answer from the computer in response to reply data (c) of the inverter is transmitted. (Even if (e) is not sent, subsequent communication is made properly.)

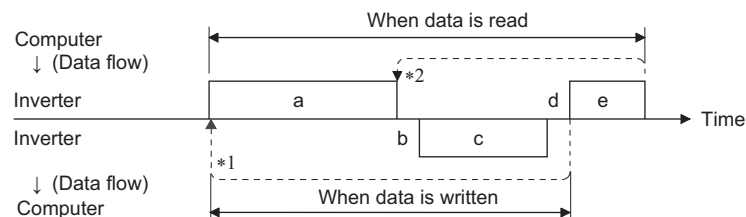

- \*1 If a data error is detected and a retry must be made, perform retry operation with the user program. The inverter output is shut off if the number of consecutive retries exceeds the parameter setting.
- \*2 On receipt of a data error occurrence, the inverter returns reply data (c) to the computer again. The inverter output is shut off if the number of consecutive data errors reaches or exceeds the parameter setting.

## ◆ Communication operation presence/absence and data format types

- Data communication between the computer and inverter is made in ASCII code (hexadecimal code).

- Communication operation presence/absence and data format types are as follows.

Symbol	Operation	Operation command	Operation frequency	Multi command	Parameter write	Inverter reset	Monitor	Parameter read	
a	Communication request is sent to the inverter in accordance with the user program in the computer.	A, A1	A	A2	A	A	B	B	
b	Inverter data processing time	With	With	With	With	Without	With	With	
c	Reply data from the inverter (Data (a) is checked for an error.)	No error <sup>*1</sup> (Request accepted)	C	C	C1 <sup>*3</sup>	C	C <sup>*2</sup>	E, E1, E2, E3	E
		With error (Request rejected)	D	D	D	D	D <sup>*2</sup>	D	D
d	Computer processing delay time	10 ms or more							
e	Reply from computer in response to reply data c (Data c is checked for error.)	No error <sup>*1</sup> (No inverter processing)	Without	Without	Without (C)	Without	Without	Without (C)	Without (C)
		With error (Inverter outputs c again.)	Without	Without	F	Without	Without	F	F

\*1 In the communication request data from the computer to the inverter, the time of 10 ms or more is also required after an acknowledgment (ACK) signal showing "No data error detected" is sent. (Refer to page 677.)

\*2 Reply from the inverter to the inverter reset request can be selected. (Refer to page 681.)

\*3 At mode error, and data range error, C1 data contains an error code. (Refer to page 686.) Except for those errors, the error is returned with data format D.

- Data writing format

#### a. Communication request data from the computer to the inverter

Format	Number of characters																		
	1	2	3	4	5	6	7	8	9	10	11	12	13	14	15	16	17	18	19
A	ENQ <sup>*1</sup>	Inverter station number <sup>*2</sup>		Instruction code <sup>*3</sup>		Data					Sum check <sup>*4</sup>								
A1	ENQ <sup>*1</sup>	Inverter station number <sup>*2</sup>		Instruction code <sup>*3</sup>		Data			Sum check <sup>*4</sup>										
A2	ENQ <sup>*1</sup>	Inverter station number <sup>*2</sup>		Instruction code <sup>*3</sup>		Send data type	Receive data type	Data 1				Data 2				Sum check <sup>*4</sup>			

#### c. Reply data from the inverter to the computer (No data error detected)

Format	Number of characters																		
	1	2	3	4	5	6	7	8	9	10	11	12	13	14	15	16	17	18	19
C	ACK <sup>*1</sup>	Inverter station number <sup>*2</sup>																	
C1	STX <sup>*1</sup>	Inverter station number <sup>*2</sup>		Send data type	Receive data type	Error code 1	Error code 2	Data 1				Data 2				ETX <sup>*1</sup>	Sum check		

#### c. Reply data from the inverter to the computer (Data error detected)

Format	Number of characters				
	1	2	3	4	5
D	NAK <sup>*1</sup>	Inverter station number <sup>*2</sup>		Error code	

\*1 A control code.

\*2 The inverter station number is specified in hexadecimal in the range of H00 to H1F (stations No. 0 to 31).

\*3 Set the delay time. When **Pr.123 PU communication waiting time setting** or **Pr.337 RS-485 communication waiting time setting** is set to other than "9999", create the communication request data without "delay time" in the data format. (The number of characters decreases by 1.)

\*4 CR+LF code: When a computer transmits data to the inverter, some computers automatically provide either one or both of the codes CR (carriage return) and LF (line feed) at the end of a data group. In this case, the same setting is required for data sent from the inverter to the computer. Use **Pr.124** or **Pr.341** for the CR+LF code setting.

- Data reading format

a. Communication request data from the computer to the inverter

Format	Number of characters								
	1	2	3	4	5	6	7	8	9
B	ENQ <sup>*1</sup>	Inverter station number <sup>*2</sup>		Instruction code <sup>*3</sup>		Sum check		*4	

c. Reply data from the inverter to the computer (No data error detected)

Format	Number of characters												
	1	2	3	4	5	6	7	8	9	10	11	12	13
E	STX <sup>*1</sup>	Inverter station number <sup>*2</sup>		Read data				ETX <sup>*1</sup>	Sum check		*4		
E1	STX <sup>*1</sup>	Inverter station number <sup>*2</sup>		Read data		ETX <sup>*1</sup>	Sum check		*4				
E2	STX <sup>*1</sup>	Inverter station number <sup>*2</sup>		Read data						ETX <sup>*1</sup>	Sum check		*4

Format	Number of characters											
	1	2	3	4 to 23				24	25	26	27	
E3	STX <sup>*1</sup>	Inverter station number <sup>*2</sup>		Read data (Inverter model information)				ETX <sup>*1</sup>	Sum check		*4	

c. Reply data from the inverter to the computer (Data error detected)

Format	Number of characters				
	1	2	3	4	5
D	NAK <sup>*1</sup>	Inverter station number <sup>*2</sup>		Error code	*4

e. Transmission data from the computer to the inverter when reading data

Format	Number of characters			
	1	2	3	4
C (No data error detected)	ACK <sup>*1</sup>	Inverter station number <sup>*2</sup>		*4
F (Data error detected)	NAK <sup>*1</sup>	Inverter station number <sup>*2</sup>		*4

\*1 A control code.

\*2 The inverter station number is specified in hexadecimal in the range of H00 to H1F (stations No. 0 to 31).

\*3 Set the delay time. When **Pr.123 PU communication waiting time setting** or **Pr.337 RS-485 communication waiting time setting** is set to other than "9999", create the communication request data without "delay time" in the data format. (The number of characters decreases by 1.)

\*4 CR+LF code: When a computer transmits data to the inverter, some computers automatically provide either one or both of the codes CR (carriage return) and LF (line feed) at the end of a data group. In this case, the same setting is required for data sent from the inverter to the computer. Use **Pr.124** or **Pr.341** for the CR+LF code setting.

## ◆ Data definitions

- Control code

Signal name	ASCII code	Description
STX	H02	Start Of Text (Start of data)
ETX	H03	End Of Text (End of data)
ENQ	H05	Enquiry (Communication request)
ACK	H06	Acknowledge (No data error detected)
LF	H0A	Line Feed
CR	H0D	Carriage Return
NAK	H15	Negative Acknowledge (Data error detected)

- Inverter station number

Specify the station number of the inverter which communicates with the computer.

- Instruction code

Specify the processing request, for example, operation or monitoring, given by the computer to the inverter. Therefore, the operation or monitoring an item is enabled by specifying the corresponding instruction code. (Refer to [page 681](#).)

- Data



Read/write data such as parameters transmitted from/to the inverter. The definitions and ranges of set data are determined in accordance with the instruction codes. (Refer to [page 681](#).)

- Time delay

Specify the delay time (time period between the time when the inverter receives data from the computer and the time when the inverter starts transmission of reply data). Set the delay time in accordance with the response time of the computer in the range of 0 to 150 ms in 10 ms increments. (For example, "1" for 10 ms or "2" for 20 ms.)

When **Pr.123 PU communication waiting time setting** or **Pr.337 RS-485 communication waiting time setting** is set to other than "9999", create the communication request data without "delay time" in the data format. (The number of characters decreases by 1.)

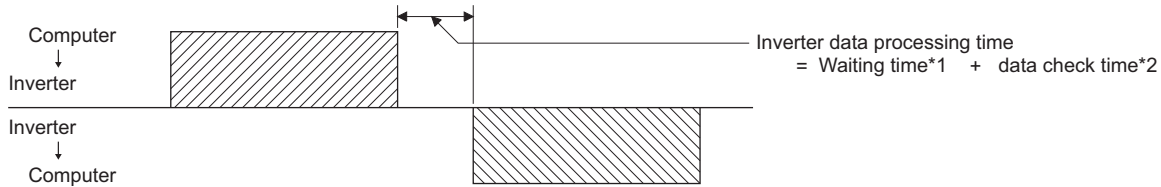

- \*1 Number set in data × 10 (ms) when **Pr.123** = "9999". **Pr.123** setting (ms) when **Pr.123** ≠ "9999".
- \*2 About 10 to 30 ms. It varies depending on the instruction code.

**NOTE**

- The data check time varies depending on the instruction code. (Refer to [page 677](#).)

- Sum check code

The sum check code is a 2-digit ASCII (hexadecimal) representing the lower 1 byte (8 bits) of the sum derived from the checked ASCII data.

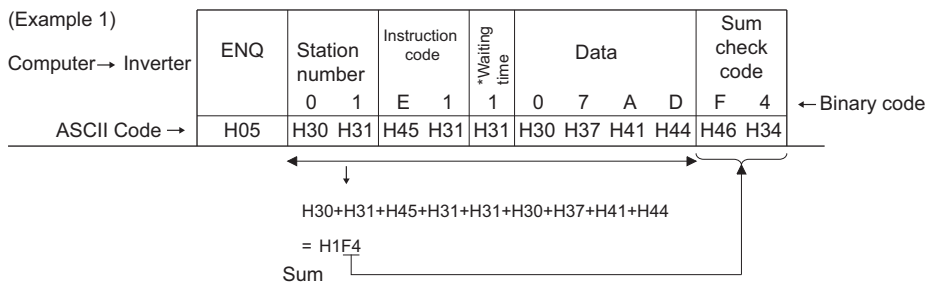

\*When the **Pr.123** or **Pr.337 (Waiting time setting)** ≠ "9999", create the communication request data without "waiting time" in the data format. (The number of characters decreases by 1.)

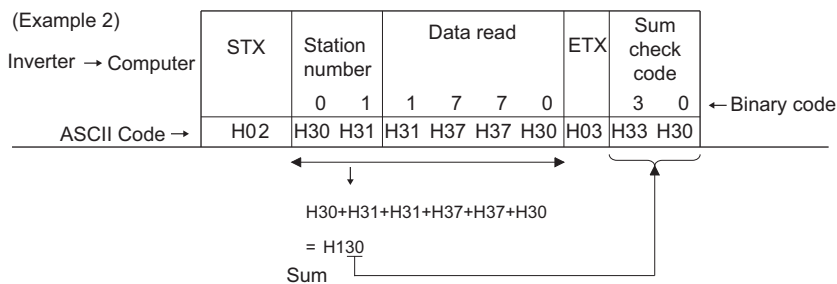

- Error code

If any error is found in the data received by the inverter, its error definition is sent back to the computer together with the NAK code.

Error code	Error item	Error description	Inverter operation
H0	Computer NAK error	The number of errors consecutively detected in communication request data from the computer is greater than the permissible number of retries.	The inverter output is shut off (E.PUE/E.SER) if error occurs continuously more than the permissible number of retries. The LF signal is output.
H1	Parity error	The parity check result does not match the specified parity.	
H2	Sum check error	The sum check code in the computer does not match that of the data received by the inverter.	
H3	Protocol error	The data received by the inverter has a grammatical mistake. Or, data receive is not completed within the predetermined time. The CR or LF code specification is not the same as the setting of the parameter.	
H4	Framing error	The stop bit length differs from the initial setting.	
H5	Overrun error	New data has been sent by the computer before the inverter completes receiving the preceding data.	
H6	—	—	—
H7	Character error	The character received is invalid (other than 0 to 9, A to F, control code).	The inverter does not accept the received data. However, the inverter output is not shut off.
H8	—	—	—
H9	—	—	—
HA	Mode error	Parameter write was attempted when the inverter does not perform computer link communication, when the operation commands are not given through communication, or during inverter operation.	The inverter does not accept the received data. However, the inverter output is not shut off.
HB	Instruction code error	The specified instruction code does not exist.	
HC	Data range error	Invalid data has been specified for parameter writing, frequency setting, etc.	
HD	—	—	—
HE	—	—	—
HF	Normal (no error)	—	—

### ◆ Response time

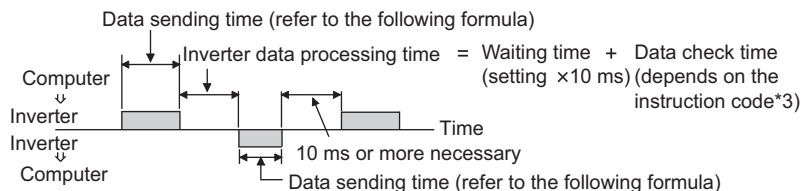

[Formula for data transmission time]

$$\frac{1}{\text{Communication speed (bps)}} \times \text{Number of data characters} *1 \times \frac{\text{Communication specifications (Total number of bits)} *2}{2} = \text{data transmission time (s)}$$

\*1 Refer to page 673.

\*2 Communication specifications

Name	Number of bits
Stop bit length	1 bit
	2 bits
Data length	7 bits
	8 bits
Parity check	With 1 bit
	Without 0

In addition to the above, 1 start bit is necessary.

Minimum number of total bits: 9 bits

Maximum number of total bits: 12 bits

Item	Check time
Monitoring, operation command, frequency setting (RAM)	Less than 12 ms
Parameter read/write, frequency setting (EEPROM)	Less than 30 ms
Parameter clear / All parameter clear	Less than 5 s
Reset command	No reply

### ◆ Retry count setting (Pr.121, Pr.335)

- Set the permissible number of retries at data receive error occurrence. (Refer to [page 676](#) for data receive error for retry.)
- When the data receive errors occur consecutively and the number of retries exceeds the permissible number setting, a communication fault (PU connector communication: E.PUE, RS-485 terminal communication: E.SER) occurs and the inverter output is shut off.
- When a data transmission error occurs while "9999" is set, the inverter does not shut off its output but outputs the Alarm (LF) signal. To use the LF signal, set "98 (positive logic) or 198 (negative logic)" in any of **Pr.190 to Pr.196 (Output terminal function selection)** to assign the function to an output terminal.

Example: PU connector communication, Pr. 121 = "1" (initial value)

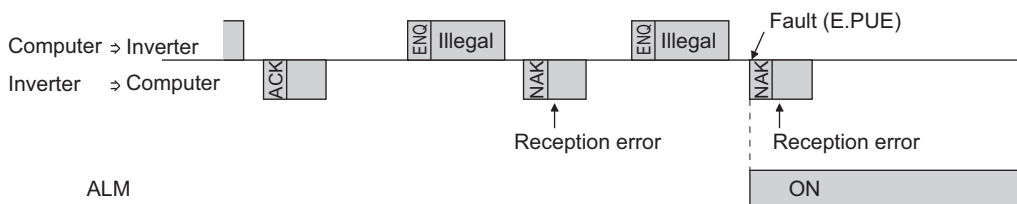

Example: PU connector communication, Pr. 121 = "9999"

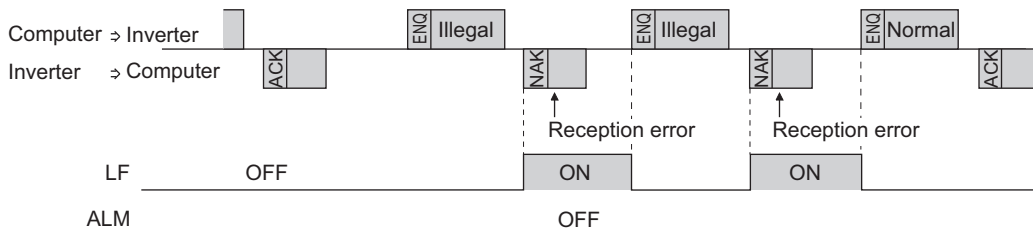

#### NOTE

- For the RS-485 terminal communication, the operation at a communication error occurrence depends on the **Pr.502 Stop mode selection at communication error** setting. (Refer to [page 663](#).)

### ◆ Signal loss detection (Pr.122, Pr.336 RS-485 communication check time interval)

- If signal loss is detected between the inverter and computer, communication error "E.PUE" (PU connector communication) or "E.SER" (RS-485 terminal communication) will occur and the inverter output is shut off.
- The LF signal is not output when a signal loss is detected. However, when a signal loss is detected via communication through the RS-485 terminals while **Pr.502 = "3 or 4"**, the LF signal is output.
- When the setting is "9999", communication check (signal loss detection) is not made.
- When the setting is "0", communication through the PU connector is not possible. The monitor items and parameter settings can be read during communication via RS-485 terminals, but a communication error (E.SER) occurs instantly when the operation mode is switched to the Network operation.
- Setting any value from 0.1 second to 999.8 seconds will enable signal loss detection. To detect signal loss, data must be sent from the computer within the communication check time interval (for further information on control codes, refer to [page 675](#)). (The inverter makes a communication check (clearing of communication check counter) regardless of the station number setting of the data sent from the master).

- Communication check is started at the first communication in the operation mode having the operation source (PU operation mode for PU connector communication in the initial setting or Network operation mode for RS-485 terminal communication).

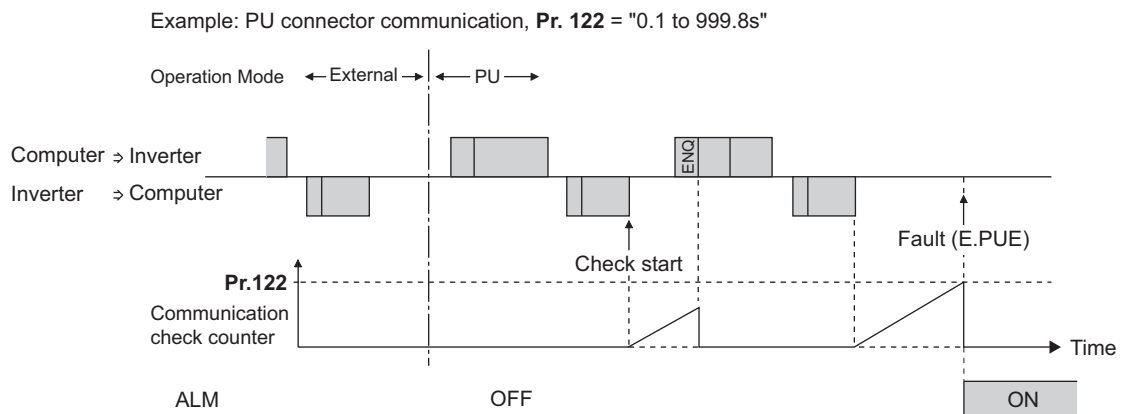

## ◆ Programming instructions

- When data from the computer has any error, the inverter does not accept that data. Hence, in the user program, always insert a retry program for data error.
- All data communication, for example, run command or monitoring, are started when the computer gives a communication request. The inverter does not return any data without the computer's request. Hence, design the program so that the computer gives a data read request for monitoring, etc. as required.
- Program example: To switch to the Network operation mode

## Microsoft® Visual C++® (Ver.6.0) programming example

```

#include <stdio.h>
#include <windows.h>

void main(void){
    HANDLE          hCom;          // Communication handle
    DCB              hDcb;        // Structure for setting communication settings
    COMMTIMEOUTS    hTim;        // Structure for setting timeouts

    char            szTx[0x10];   // Send buffer
    char            szRx[0x10];   // Receive buffer
    char            szCommand[0x10]; // Command
    int             nTx,nRx;      // For storing buffer size
    int             nSum;         // For calculating sum code
    BOOL            bRet;
    int             nRet;
    int             i;

    // **** Open COM1 port ****
    hCom = CreateFile("COM1", (GENERIC_READ | GENERIC_WRITE), 0, NULL, OPEN_EXISTING, FILE_ATTRIBUTE_NORMAL, NULL);
    if(hCom != NULL) {
        // **** Set COM1 port communication ****
        GetCommState(hCom,&hDcb); // Get current communication information
        hDcb.DCBlength = sizeof(DCB); // Structure size setting
        hDcb.BaudRate = 19200; // Communication speed = 19200 bps
        hDcb.ByteSize = 8; // Data length = 8 bits
        hDcb.Parity = 2; // Parity check at even numbers
        hDcb.StopBits = 2; // Stop bit = 2 bits
        bRet = SetCommState(hCom,&hDcb); // Setting of changed communication information
        if(bRet == TRUE) {
            // **** Set COM1 port timeout ****
            GetCommTimeouts(hCom,&hTim); // Get current timeout values
            hTim.WriteTotalTimeoutConstant = 1000; // Write timeout 1 second
            hTim.ReadTotalTimeoutConstant = 1000; // Read timeout 1 second
            hTim.ReadTotalTimeoutConstantSetCommTimeouts(hCom,&hTim); // Setting of changed timeout values
            // **** Setting of command for switching the station number 1 inverter to the Network operation mode ****
            sprintf(szCommand,"01FB10000"); // Send data (NET operation write)
            nTx = strlen(szCommand); // Send data size
            // **** Generate sum code ****
            nSum = 0; // Initialize sum data
            for(i = 0;i < nTx;i++) {
                nSum += szCommand[i]; // Calculate sum code
                nSum &= (0xff); // Mask data
            }

            // **** Generate send data ****
            memset(szTx,0,sizeof(szTx)); // Initialize send buffer
            memset(szRx,0,sizeof(szRx)); // Initialize receive buffer
            sprintf(szTx,"%5s%02X",szCommand,nSum); // ENQ code + send data + sum code
            nTx = 1 + nTx + 2; // ENQ code + number of send data + number of sum codes

            nRet = WriteFile(hCom,szTx,nTx,&nTx,NULL);
            // **** Send ****
            if(nRet != 0) {
                nRet = ReadFile(hCom,szRx,sizeof(szRx),&nRx,NULL);
                // **** Receive ****
                if(nRet != 0) {
                    // **** Display receive data ****
                    for(i = 0;i < nRx;i++) {
                        printf("%02X ",(BYTE)szRx[i]); // Output received data to console
                        // Display ASCII code in Hexadecimal! In case of 0, "30" is displayed.
                    }
                    printf("\n\r");
                }
            }
        }
        CloseHandle(hCom); // Close communication port
    }
}

```

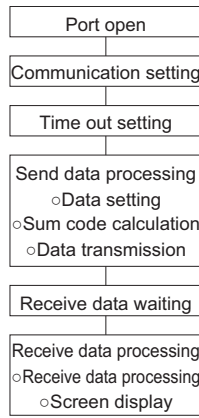

**⚠ CAUTION**

- Always set the communication check time interval before starting operation to prevent hazardous conditions.
- Data communication is not started automatically but is made only once when the computer provides a communication request. If communication is disabled during operation due to signal cable breakage etc., the inverter cannot be stopped. When the communication check time interval has elapsed, the inverter output will be shut off (E.PUE, E.SER). Turn the RES signal of the inverter ON or shut off the power supply to coast the motor to a stop.
- If communication is broken due to signal cable breakage, computer fault etc., the inverter does not detect such a fault. This should be fully noted.

**◆ Setting items and set data**

- After completion of parameter settings, set the instruction codes and data, then start communication from the computer to allow various types of operation control and monitoring.

Item	Read/write	Instruction code	Data description	Number of data digits (format)*1
Operation mode	Read	H7B	H0000: Network operation H0001: External operation, External operation (JOG operation) H0002: PU operation, External/PU combined operation, PUJOG operation	4 digits (B and E/D)
	Write	HFB	H0000: Network operation (Setting is available via communication through the RS-485 terminals.) H0001: External operation H0002: PU operation (Setting is available via communication through the PU connector.)	4 digits (A and C/D)

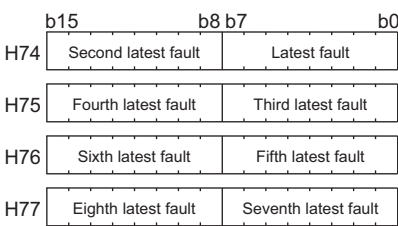
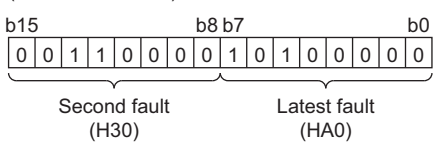
Item	Read/write	Instruction code	Data description	Number of data digits (format) <sup>*1</sup>	
Monitor	Output frequency / speed	Read	H6F	H0000 to HFFFF: Output frequency in 0.01 Hz increments. (The display can be changed to the rotations per minute using <b>Pr.37</b> , <b>Pr.144</b> and <b>Pr.811</b> . (Refer to <a href="#">page 446</a> .)	4 digits (B and E/D)
	Output current	Read	H70	H0000 to HFFFF: Output current (hexadecimal) Increment 0.01 A (FR-A820-03160(55K) or lower, FR-A840-01800(55K) or lower) Increment 0.1 A (FR-A820-03800(75K) or higher, FR-A840-02160(75K) or higher)	4 digits (B and E/D)
	Output voltage	Read	H71	H0000 to HFFFF: Output voltage (hexadecimal) in 0.1 V increments	4 digits (B and E/D)
	Special monitor	Read	H72	H0000 to HFFFF: Data of the monitor item selected with the instruction code HF3.	4 digits (B and E/D)
	Special monitor selection No.	Read	H73	Monitor selection data (Refer to <a href="#">page 446</a> for details on selection No.)	2 digits (B and E1/D)
		Write	HF3		2 digits (A1 and C/D)
	Fault record	Read	H74 to H77	<p>H0000 to HFFFF: Two fault records per code.</p>  <p>Fault record display example (instruction code H74)</p> <p>With the read data H30A0 (Second fault : THT) (Latest fault : OPT)</p>  <p>(Refer to <a href="#">page 776</a> for details on fault record read data.)</p>	4 digits (B and E/D)
	Operation command (extended)	Write	HF9	Control input commands such as the Forward rotation command (STF) signal and the Reverse rotation command (STR) signal can be set. (For the details, refer to <a href="#">page 685</a> .)	4 digits (A and C/D)
	Operation command	Write	HFA		2 digits (A1 and C/D)
	Inverter status monitor (extended)	Read	H79	The states of the output signals such as the Forward rotation output, Reverse rotation output, and Inverter running (RUN) signals can be monitored. (For the details, refer to <a href="#">page 685</a> .)	4 digits (B and E/D)
Inverter status monitor	Read	H7A	2 digits (B and E1/D)		
Set frequency (RAM)	Read	H6D	Read the set frequency/speed from the RAM or EEPROM. H0000 to HFFFF: Set frequency in 0.01 Hz increments. (The display can be changed to the rotations per minute using <b>Pr.37</b> , <b>Pr.144</b> and <b>Pr.811</b> . (Refer to <a href="#">page 446</a> .)	4 digits (B and E/D)	
Set frequency (EEPROM)		H6E			
Set frequency (RAM)	Write	HED	Write the set frequency/speed into the RAM or EEPROM. H0000 to HE678 (0 to 590.00 Hz): frequency in 0.01 Hz increments. (The display can be changed to the rotations per minute using <b>Pr.37</b> , <b>Pr.144</b> and <b>Pr.811</b> . (Refer to <a href="#">page 446</a> .) To change the set frequency consecutively, write data to the inverter RAM. (Instruction code: HED)	4 digits (A and C/D)	
Set frequency (RAM, EEPROM)		HEE			
Inverter reset	Write	HFD	H9696: Inverter reset As the inverter is reset at the start of communication by the computer, the inverter cannot send reply data back to the computer.	4 digits (A and C/D)	
			H9966: Inverter reset After the computer correctly starts communication and send data to the inverter, the inverter returns the ACK signal to the computer before being reset.	4 digits (A and D)	

Item	Read/write	Instruction code	Data description	Number of data digits (format) <sup>*1</sup>	
Fault history clear	Write	HF4	H9696: Fault history is cleared.	4 digits (A,C/D)	
Parameter clear / All parameter clear	Write	HFC	All parameters return to initial values. Whether to clear communication parameters or not can be selected according to the data. • Parameter clear H9696: Parameters including communication parameters are cleared. H5A5A: Parameters other than communication parameters are cleared. <sup>*2</sup> • All parameter clear H9966: Parameters including communication parameters are cleared. H55AA: Parameters other than communication parameters are cleared. <sup>*2</sup> For details on whether or not to clear parameters, refer to <a href="#">page 864</a> . When a clear is performed with H9696 or H9966, communication related parameter settings also return to the initial values. When resuming the operation, set the parameters again. Performing a clear will clear the instruction code HEC, HF3, and HFF settings. Only H9966 and H55AA (All parameter clear) are valid when a password is registered (refer to <a href="#">page 348</a> ).	4 digits (A and C/D)	
Parameter	Read	H00 to H6B	Refer to the instruction code ( <a href="#">page 864</a> ) and write and/or read parameter values as required. When setting <b>Pr.100</b> and later, the link parameter extended setting must be set.	4 digits (B and E/D)	
	Write	H80 to HEB		4 digits (A and C/D)	
Link parameter extended setting	Read	H7F	Parameter settings are changed according to the instruction code settings. For details on the settings, refer to the extended code in the instruction code list (on <a href="#">page 864</a> ).	2 digits (B and E1/D)	
	Write	HFF		2 digits (A1 and C/D)	
Second parameter changing (instruction code HFF = 1, 9)	Read	H6C	When setting the calibration parameters <sup>*3</sup> H00: Frequency <sup>*4</sup> H01: Parameter-set analog value H02: Analog value input from terminal	2 digits (B and E1/D)	
	Write	HEC		2 digits (A1 and C/D)	
Multi command	Read/write	HF0	Available for writing 2 commands, and monitoring 2 items for reading data. (Refer to <a href="#">page 686</a> for details.)	10 digits (A2 and C1/D)	
Product profile	Model	Read	H7C	The inverter model can be read in ASCII code. "H20" (blank code) is set for blank area. Example) FR-A840-1 (FM type): H46,H52,H2D,H41,H38,H34,H30,H2D,H31,H20,H20...H20	20 digits (B and E3/D)
	Capacity	Read	H7D	The capacity in the inverter model can be read in ASCII code. Data is read in increments of 0.1 kW, and rounds down to 0.01 kW increments. "H20" (blank code) is set for blank area. Example) 0.75K: " 7" (H20, H20, H20, H20, H20, H37)	6 digits (B and E2/D)

\*1 Refer to [page 673](#) for data formats (A, A1, A2, B, C, C1, D, E, E1, E2, E3, F).

\*2 Turning OFF the power supply while clearing parameters with H5A5A or H55AA returns the communication parameter settings to the initial settings.

\*3 Refer to the following calibration parameter list for details on the calibration parameters.

\*4 The gain frequency can be also written using **Pr.125** (instruction code: H99) or **Pr.126** (instruction code: H9A).

#### NOTE

- Set 65520 (HFFF0) as a parameter value "8888" and 65535 (HFFFF) as "9999".
- For the instruction codes HFF, HEC, and HF3, their values once written are held, but cleared to zero when an inverter reset or all clear is performed.
- When a 32-bit parameter setting or monitor item is read and the value to be read exceeds HFFFF, HFFFF is returned.

Example) When reading the **C3 (Pr.902)** and **C6 (Pr.904)** settings from the inverter of station No. 0.

	Computer send data	Inverter send data	Description
a	ENQ 00 FF 0 01 7D	ACK 00	"H01" is set in the extended link parameter.
b	ENQ 00 EC 0 01 79	ACK 00	"H01" is set in the second parameter changing.
c	ENQ 00 5E 0 0A	STX 00 0000 ETX 20	<b>C3 (Pr.902)</b> is read. 0% is read.
d	ENQ 00 60 0 F6	STX 00 0000 ETX 20	<b>C6 (Pr.904)</b> is read. 0% is read.

To read/write **C3 (Pr.902)** or **C6 (Pr.904)** after inverter reset or parameter clear, execute from (a) again.



## ◆ List of calibration parameters

Pr.	Name	Instruction code		
		Read	Write	Extended
C2 (902)	Terminal 2 frequency setting bias frequency	5E	DE	1
C3 (902)	Terminal 2 frequency setting bias	5E	DE	1
125 (903)	Terminal 2 frequency setting gain frequency	5F	DF	1
C4 (903)	Terminal 2 frequency setting gain	5F	DF	1
C5 (904)	Terminal 4 frequency setting bias frequency	60	E0	1
C6 (904)	Terminal 4 frequency setting bias	60	E0	1
126 (905)	Terminal 4 frequency setting gain frequency	61	E1	1
C7 (905)	Terminal 4 frequency setting gain	61	E1	1
C12 (917)	Terminal 1 bias frequency (speed)	11	91	9
C13 (917)	Terminal 1 bias (speed)	11	91	9
C14 (918)	Terminal 1 gain frequency (speed)	12	92	9
C15 (918)	Terminal 1 gain (speed)	12	92	9
C16 (919)	Terminal 1 bias command (torque/magnetic flux)	13	93	9
C17 (919)	Terminal 1 bias (torque/magnetic flux)	13	93	9
C18 (920)	Terminal 1 gain command (torque/magnetic flux)	14	94	9
C19 (920)	Terminal 1 gain (torque/magnetic flux)	14	94	9
C8 (930)	Current output bias signal	1E	9E	9
C9 (930)	Current output bias current	1E	9E	9
C10 (931)	Current output gain signal	1F	9F	9
C11 (931)	Current output gain current	1F	9F	9
C38 (932)	Terminal 4 bias command (torque/magnetic flux)	20	A0	9
C39 (932)	Terminal 4 bias (torque/magnetic flux)	20	A0	9
C40 (933)	Terminal 4 gain command (torque/magnetic flux)	21	A1	9
C41 (933)	Terminal 4 gain (torque/magnetic flux)	21	A1	9
C42 (934)	PID display bias coefficient	22	A2	9
C43 (934)	PID display bias analog value	22	A2	9
C44 (935)	PID display gain coefficient	23	A3	9
C45 (935)	PID display gain analog value	23	A3	9

## ◆ Operation command

Item	Instruction code	Bit length	Description <sup>*1*4</sup>	Example
Operation command	HFA	8 bits	b0: AU (Terminal 4 input selection) b1: Forward rotation command b2: Reverse rotation command b3: RL (Low-speed operation command) b4: RM (Middle-speed operation command) b5: RH (High-speed operation command) b6: RT (Second function selection) b7: MRS (Output stop) <sup>*2</sup>	[Example 1] H02 Forward rotation b7 b0 0 0 0 0 0 0 1 0  [Example 2] H00 Stop b7 b0 0 0 0 0 0 0 0 0
Operation command (extended)	HF9	16 bits	b0: AU (Terminal 4 input selection) b1: Forward rotation command b2: Reverse rotation command b3: RL (Low-speed operation command) b4: RM (Middle-speed operation command) b5: RH (High-speed operation command) b6: RT (Second function selection) b7: MRS (Output stop) <sup>*2</sup> b8: JOG (Jog operation selection) <sup>*3</sup> b9: CS (Selection of automatic restart after instantaneous power failure / flying start) <sup>*3</sup> b10: STP (STOP) (Start self-holding selection) <sup>*3</sup> b11: RES (Inverter reset) <sup>*3</sup> b12 to b15: –	[Example 1] H0002 Forward rotation b15 b0 0 0 0 0 0 0 0 0 0 0 0 0 0 0 1 0  [Example 2] H0804 Low-speed reverse operation (When Pr. 189 RES terminal function selection is set to "0") b15 b0 0 0 0 0 1 0 0 0 0 0 0 0 0 0 1 0

\*1 The signal within parentheses ( ) is the initial status. The description changes depending on the setting of Pr.180 to Pr.189 (Input terminal function selection) (page 521).

\*2 The Inverter run enable signal is in the initial status for the separated converter type.

\*3 JOG operation/automatic restart after instantaneous power failure/start self-holding selection/reset cannot be controlled over a network, so in the initial status bit 8 to bit 11 are invalid. To use bit 8 to bit 11, change the signal by Pr.185, Pr.186, Pr.188, or Pr.189 (Input terminal function selection) (page 521) (A reset can be executed by the instruction code HFD.)

\*4 During RS-485 communication through the PU connector, only the Forward rotation command and Reverse rotation command signals can be used.

## ◆ Inverter status monitor

Item	Instruction code	Bit length	Description <sup>*1</sup>	Example
Inverter status monitor	H7A	8 bits	b0: RUN (Inverter running) b1: Forward rotation output b2: Reverse rotation output b3: SU (Up to frequency) b4: OL (Overload warning) b5: IPF (Instantaneous power failure/undervoltage) <sup>*2</sup> b6: FU (Output frequency detection) b7: ABC1 (Fault)	[Example 1] H03... During forward rotation b7 b0 0 0 0 0 0 0 1 1  [Example 2] H80... Stop at fault occurrence b7 b0 1 0 0 0 0 0 0 0
Inverter status monitor (extended)	H79	16 bits	b0: RUN (Inverter running) b1: Forward rotation output b2: Reverse rotation output b3: SU (Up to frequency) b4: OL (Overload warning) b5: IPF (Instantaneous power failure/undervoltage) <sup>*2</sup> b6: FU (Output frequency detection) b7: ABC1 (Fault) b8: ABC2 (–) b9: Safety monitor output b10 to b14: – b15: Fault occurrence	[Example 1] H0003... During forward rotation b15 b0 0 0 0 0 0 0 0 0 0 0 0 0 0 0 1 1  [Example 2] H8080... Stop at fault occurrence b15 b0 1 0 0 0 0 0 0 0 1 0 0 0 0 0 0 0

\*1 The signal within parentheses ( ) is the initial status. The description changes depending on the setting of Pr.190 to Pr.196 (Output terminal function selection).

\*2 No function is assigned in the initial status for the separated converter type.

## ◆ Multi command (HF0)

- Sending data format from computer to inverter

Format	Number of characters																		
	1	2	3	4	5	6	7	8	9	10	11	12	13	14	15	16	17	18	19
A2	ENQ	Inverter station number	Instruction code (HF0)	Time delay	Send data type <sup>*1</sup>	Receive data type <sup>*2</sup>	Data 1 <sup>*3</sup>	Data 2 <sup>*3</sup>									Sum check	CR/LF	

- Reply data format from inverter to computer (No data error detected)

Format	Number of characters																		
	1	2	3	4	5	6	7	8	9	10	11	12	13	14	15	16	17	18	19
C1	STX	Inverter station number	Send data type <sup>*1</sup>	Receive data type <sup>*2</sup>	Error code 1 <sup>*5</sup>	Error code 2 <sup>*5</sup>	Data 1 <sup>*4</sup>	Data 2 <sup>*4</sup>									ETX	Sum check	CR/LF

\*1 Specify the data type of sending data (from computer to inverter).

\*2 Specify the data type of reply data (from inverter to computer).

\*3 Combination of data 1 and data 2 for sending

Data type	Data 1	Data 2	Remarks
0	Operation command (extended)	Set frequency (RAM)	Run command (extended) is same as instruction code HF9. (Refer to page 685.)
1	Operation command (extended)	Set frequency (RAM, EEPROM)	

\*4 Combination of data 1 and data 2 for reply

Data type	Data 1	Data 2	Remarks
0	Inverter status monitor (extended)	Output frequency (speed)	Inverter status monitor (extended) is same as instruction code H79. (Refer to page 685.) Replies the monitor item specified in instruction code HF3 for special monitor. (Refer to page 446.)
1	Inverter status monitor (extended)	Special monitor	

\*5 The error code for sending data 1 is set in error code 1, and the error code for sending data 2 is set in error code 2. Mode error (HA), instruction code error (HB), data range error (HC) or no error (HF) is replied. (Refer to page 776 for details on the error codes.)

## 5.15.6 MODBUS RTU communication specification

Operation by MODBUS RTU communication or parameter setting is possible by using the MODBUS RTU communication protocol through the RS-485 terminals of the inverter.

Pr.	Name	Initial value	Setting range	Description	
331 N030	RS-485 communication station number	0	0	Broadcast communication	
			1 to 247	Specify the inverter station number. Enter the inverter station numbers when two or more inverters are connected to one personal computer.	
332 N031	RS-485 communication speed	96	3, 6, 12, 24, 48, 96, 192, 384, 576, 768, 1152	Select the communication speed. The setting value × 100 equals the communication speed. For example, enter 96 to set the communication speed of 9600 bps.	
N033	RS-485 communication stop bit length	1	0	Stop bit length 1 bit	Valid when Pr.N034 (Pr.334) = "0"
			1	Stop bit length 2 bits	
333	RS-485 communication stop bit length / data length	1	0	Stop bit length 1 bit	Valid when Pr.334 = "0"
			1	Stop bit length 2 bits	
			10	Stop bit length 1 bit	
			11	Stop bit length 2 bits	
334 N034	RS-485 communication parity check selection	2	0	Without parity check Stop bit length 1 bit / 2 bits (depends on the setting of Pr.333)	
			1	With parity check at odd numbers. Stop bit length: 1 bit.	
			2	With parity check at even numbers. Stop bit length: 1 bit.	
343 N080	Communication error count	0	—	Displays the communication error count during MODBUS RTU communication. Read-only.	
539 N002	MODBUS RTU communication check time interval	9999	0	MODBUS RTU communication is available, but the inverter output is shut off in the NET operation mode.	
			0.1 to 999.8 s	Set the interval of the communication check (signal loss detection) time (same specifications as Pr.122).	
			9999	No communication check (signal loss detection)	
549 N000	Protocol selection	0	0	Mitsubishi inverter protocol (computer link)	
			1	MODBUS RTU protocol	

#### NOTE

- To use the MODBUS RTU protocol, set "1" in **Pr.549 Protocol selection**.
- If MODBUS RTU communication is performed from the master to the address 0 (station number 0), the data is broadcasted, and the inverter does not send any reply to the master. To obtain replies from the inverter, set **Pr.331 RS-485 communication station number** ≠ "0 (initial value)".
- Some functions are disabled in broadcast communication. (Refer to [page 689](#).)
- If a communication option is installed with **Pr.550 NET mode operation command source selection** = "9999 (initial value)", commands (operation commands) transmitted via RS-485 terminals become invalid. (Refer to [page 400](#).)

## ◆ Communication specifications

- The communication specifications are shown in the following table.

Item	Description	Related parameter	
Communication protocol	MODBUS RTU protocol	Pr.549	
Conforming standard	EIA-485 (RS-485)	—	
Number of connectable units	1: N (maximum 32 units), setting is 0 to 247 stations	Pr.331	
Communication speed	Selected among 300/600/1200/2400/4800/9600/19200/38400/57600/76800/115200 bps.	Pr.332	
Control procedure	Asynchronous method	—	
Communication method	Half-duplex system	—	
Communication specifications	Character system	Binary (fixed at 8 bits)	—
	Start bit	1 bit	—
	Stop bit length	Select from the following three types: No parity check, stop bit length 1 bit / 2 bits (depends on the setting of Pr.333).	Pr.333 Pr.334
	Parity check	Odd parity check, stop bit length 1 bit. Even parity check, stop bit length 1 bit.	
	Error check	CRC code check	—
	Terminator	Not available	—
Time delay setting	Not available	—	

## ◆ Outline

- The MODBUS communication protocol was developed by Modicon for programmable controllers.
- The MODBUS protocol uses exclusive message frames to perform serial communication between a master and slaves. These exclusive message frames are provided with a feature called "functions" that allows data to be read or written. These functions can be used to read or write parameters from the inverter, write input commands to the inverter or check the inverter's operating status, for example. This product classifies the data of each inverter into holding register area (register address 40001 to 49999). The master can communicate with inverters (slaves) by accessing pre-assigned holding register addresses.

### NOTE

- There are two serial transmission modes, the ASCII (American Standard Code for Information Interchange) mode and the RTU (Remote Terminal Unit) mode. However, this product supports only the RTU mode, which transfers 1 byte data (8 bits) as it is. Also, only communication protocol is defined by the MODBUS protocol. Physical layers are not stipulated.

## ◆ Message format

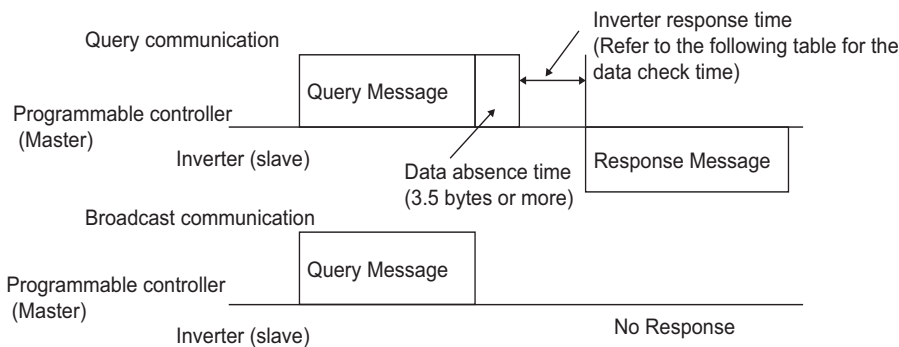

- Data check time

Item	Check time
Monitoring, operation command, frequency setting (RAM)	Less than 12 ms
Parameter read/write, frequency setting (EEPROM)	Less than 30 ms
Parameter clear / All parameter clear	< 5 s
Reset command	No reply

- Query  
A message is sent to the slave (the inverter) having the address specified by the master.
- Normal response  
After the query from the master is received, the slave executes the request function, and returns the corresponding normal response to the master.
- Error Response  
When an invalid function code, address or data is received by the slave, the error response is returned to the master. This response is appended with an error code that indicates the reason why the request from the master could not be executed.  
This response cannot be returned for errors, detected by the hardware, frame error and CRC check error.
- Broadcast  
The master can broadcast messages to all slaves by specifying address 0. All slaves that receive a message from the master execute the requested function. With this type of communication, slaves do not return a response to the master.

### NOTE

- During broadcast communication, functions are executed regardless of the set inverter station number (**Pr.331**).

## ◆ Message frame (protocol)

- Communication method

Basically, the master sends a query message (inquiry), and slaves return a response message (response). At normal communication, the device address and function code are copied as they are, and at erroneous communication (illegal function code or data code), bit 7 (= H80) of the function code is turned ON, and the error code is set at data bytes.

Query message from Master

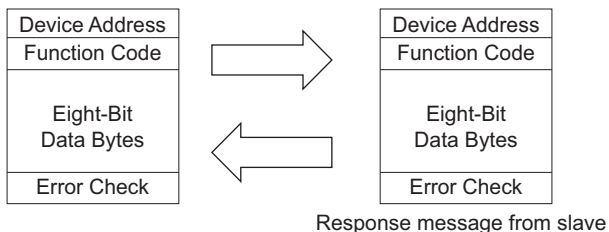

Message frames comprise the four message fields shown in the figures above.

A slave recognizes message data as one message when a 3.5 character long no-data time (T1: start/end) is added before and after the data.

- Details of protocol

The following table explains the four message fields.

Start	Address	Function	Data	CRC check		End
T1	8 bits	8 bits	n × 8 bits	L 8 bits	H 8 bits	T1

Message field	Description
Address field	"0 to 247" can be set in the single-byte (8-bit) length field. Set "0" when sending broadcast messages (instructions to all addresses), and "1 to 247" to send messages to individual slaves. The response from the slave also contains the address set by the master. The value set in <b>Pr.331 RS-485 communication station number</b> is the slave address.
Function field	"1 to 255" can be set as the function code in the single-byte (8-bit) length field. The master sets the function to be sent to the slave as the request, and the slave performs the requested operation. Refer to the function code list for details on the supported function codes. An error response is generated when a function code other than those in the function code list is set. The normal response from the slave contains the function code set by the master. The error response contains H80 and the function code.
Data field	The format changes according the function code. (Refer to <a href="#">page 690</a> .) The data, for example, includes the byte count, number of bytes, and accessing content of holding registers.
CRC check field	Errors in the received message frame are detected. Errors are detected in the CRC check, and the 2 bytes length data is appended to the message. When the CRC is appended to the message, the lower bytes of the CRC are appended first, followed by the upper bytes. The CRC value is calculated by the sender that appends the CRC to the message. The receiver recalculates the CRC while the message is being received, and compares the calculation result against the actual value that was received in the error check field. If the two values do not match, the result is treated as an error.

## ◆ Function code list

Function name	Read/write	Code	Outline	Broadcast communication	Message format reference page
Read holding register	Read	H03	The data of the holding registers is read. The various data of the inverter can be read from MODBUS registers. System environmental variable (Refer to <a href="#">page 695.</a> ) Real time monitor (Refer to <a href="#">page 447.</a> ) Fault history (Refer to <a href="#">page 697.</a> ) Product profile (Refer to <a href="#">page 698.</a> ) Inverter parameters (Refer to <a href="#">page 696.</a> )	Not available	<a href="#">page 690</a>
Preset single register	Write	H06	Data is written to a holding register. Data can be written to MODBUS registers to output instructions to the inverter or set parameters. System environmental variable (Refer to <a href="#">page 695.</a> ) Inverter parameters (Refer to <a href="#">page 696.</a> )	Available	<a href="#">page 691</a>
Diagnostics	Read	H08	Functions are diagnosed. (communication check only) A communication check can be made since the query message is sent and the query message is returned as it is as the return message (subfunction code H00 function). Subfunction code H00 (Return query data).	Not available	<a href="#">page 691</a>
Preset multiple registers	Write	H10	Data is written to multiple consecutive holding registers. Data can be written to consecutive multiple MODBUS registers to output instructions to the inverter or set parameters. System environmental variable (Refer to <a href="#">page 695.</a> ) Inverter parameters (Refer to <a href="#">page 696.</a> )	Available	<a href="#">page 692</a>
Read holding register access log	Read	H46	The number of registers that were successfully accessed by the previous communication is read. Queries by function codes H03 and H10 are supported. The number and start address of holding registers successfully accessed by the previous communication are returned. "0" is returned for both the number and start address for queries other than function code H03 and H10.	Not available	<a href="#">page 693</a>

## ◆ Read holding register (reading data of holding registers) (H03 or 03)

- Query message

a. Slave address	b. Function	c. Starting address		d. No. of points		CRC check	
(8 bits)	H03 (8 bits)	H (8 bits)	L (8 bits)	H (8 bits)	L (8 bits)	L (8 bits)	H (8 bits)

- Normal response (Response message)

a. Slave address	b. Function	e. Byte count	f. Data			CRC check	
(8 bits)	H03 (8 bits)	(8 bits)	H (8 bits)	L (8 bits)	... (n × 16 bits)	L (8 bits)	H (8 bits)

- Query message setting

Message		Description
a	Slave address	Set the address to send messages to. Broadcast communication is not possible. (Invalid when "0" is set.)
b	Function	Set H03.
c	Starting address	Set the holding register address from which to start reading the data. Starting address = start register address (decimal) - 40001 For example, when starting register address 0001 is set, the data of holding register address 40002 is read.
d	No. of points	Set the number of holding registers for reading data. Data can be read from up to 125 registers.

- Content of normal response

Message		Description
e	Byte count	The setting range is H02 to HFA (2 to 250). Twice the number of reads specified by (d) is set.
f	Data	The amount of data specified by (d) is set. Read data is output Hi bytes first followed by Lo bytes, and is arranged as follows: data of start address, data of start address+1, data of start address+2, and so forth.

■ **Example) Read the register values of 41004 (Pr.4) to 41006 (Pr.6) from slave address 17 (H11).**

Query message

Slave address	Function	Starting address		No. of points		CRC check	
H11 (8 bits)	H03 (8 bits)	H03 (8 bits)	HEB (8 bits)	H00 (8 bits)	H03 (8 bits)	H77 (8 bits)	H2B (8 bits)

Normal response (Response message)

Slave address	Function	Byte count	Data						CRC check	
H11 (8 bits)	H03 (8 bits)	H06 (8 bits)	H17 (8 bits)	H70 (8 bits)	H0B (8 bits)	HB8 (8 bits)	H03 (8 bits)	HE8 (8 bits)	H2C (8 bits)	HE6 (8 bits)

Read value

Register 41004 (Pr.4): H1770 (60.00 Hz)

Register 41005 (Pr.5): H0BB8 (30.00 Hz)

Register 41006 (Pr.6): H03E8 (10.00 Hz)

◆ **Preset single register (writing data to holding registers) (H06 or 06)**

- The content of the system environmental variables and inverter parameters (refer to [page 694](#)) assigned to the holding register area can be written.
- Query message

a. Slave address	b. Function	c. Register address		d. Preset data		CRC check	
(8 bits)	H06 (8 bits)	H (8 bits)	L (8 bits)	H (8 bits)	L (8 bits)	L (8 bits)	H (8 bits)

- Normal response (Response message)

a. Slave address	b. Function	c. Register address		d. Preset data		CRC check	
(8 bits)	H06 (8 bits)	H (8 bits)	L (8 bits)	H (8 bits)	L (8 bits)	L (8 bits)	H (8 bits)

- Query message setting

Message	Description
a Slave address	Set the address to send messages to. Setting "0" enables broadcast communication.
b Function	Set H06.
c Register address	Set the holding register address to write data to. Register address = holding register address (decimal) - 40001 For example, when register address 0001 is set, data is written to holding register address 40002.
d Preset Data	Set the data to write to the holding register. Write data is fixed at 2 bytes.

- Content of normal response

The contents in the normal response (a to d, including the CRC check) are the same as those in the query messages.

In the case of broadcast communication, no response is returned.

■ **Example) Write 60 Hz (H1770) to 40014 (set frequency RAM) of slave address 5 (H05).**

Query message

Slave address	Function	Register address		Preset data		CRC check	
H05 (8 bits)	H06 (8 bits)	H00 (8 bits)	H0D (8 bits)	H17 (8 bits)	H70 (8 bits)	H17 (8 bits)	H99 (8 bits)

Normal response (Response message)

The same data as those in the query message

**NOTE**

- With broadcast communication, no response is generated even if a query is executed, so when the next query is made, it must be made after waiting for the inverter data processing time after the previous query is executed.

◆ **Diagnostics (diagnosis of functions) (H08 or 08)**

- A communication check can be made since the query message is sent and the query message is returned as it is as the return message (subfunction code H00 function). Subfunction code H00 (Return query data)



- Query message

a. Slave address	b. Function	c. Subfunction		d. Data		CRC check	
(8 bits)	H08 (8 bits)	H00 (8 bits)	H00 (8 bits)	H (8 bits)	L (8 bits)	L (8 bits)	H (8 bits)

- Normal response (Response message)

a. Slave address	b. Function	c. Subfunction		d. Data		CRC check	
(8 bits)	H08 (8 bits)	H00 (8 bits)	H00 (8 bits)	H (8 bits)	L (8 bits)	L (8 bits)	H (8 bits)

- Query message setting

Message		Description
a	Slave address	Set the address to send messages to. Broadcast communication is not possible. (Invalid when "0" is set.)
b	Function	Set H08.
c	Subfunction	Set H0000.
d	Data	Any 2-byte long data can be set. The setting range is H0000 to HFFFF.

- Content of normal response

The contents in the normal response (a to d, including the CRC check) are the same as those in the query messages.

### NOTE

- With broadcast communication, no response is generated even if a query is executed, so when the next query is made, it must be made after waiting for the inverter data processing time after the previous query is executed.

## ◆ Preset multiple registers (writing data to multiple holding registers) (H10 or 16)

- Data can be written to multiple holding registers.
- Query message

a. Slave address	b. Function	c. Starting address		d. No. of registers		e. Byte count	f. Data			CRC check	
(8 bits)	H10 (8 bits)	H (8 bits)	L (8 bits)	H (8 bits)	L (8 bits)	(8 bits)	H (8 bits)	L (8 bits)	... (n × 2 × 8 bits)	L (8 bits)	H (8 bits)

- Normal response (Response message)

a. Slave address	b. Function	c. Starting address		d. No. of registers		CRC check	
(8 bits)	H10 (8 bits)	H (8 bits)	L (8 bits)	H (8 bits)	L (8 bits)	L (8 bits)	H (8 bits)

- Query message setting

Message		Description
a	Slave address	Set the address to send messages to. Setting "0" enables broadcast communication.
b	Function	Set H10.
c	Starting address	Set the holding register address from which to start writing the data. Starting address = start register address (decimal) - 40001 For example, when starting address 0001 is set, data is written to holding register 40002.
d	No. of registers	Set the number of holding registers for writing data. Data can be written to up to 125 registers.
e	Byte count	The setting range is H02 to HFA (2 to 250). Set twice the value specified by d.
f	Data	Set the amount of data specified by d. Write data is output Hi bytes first followed by Lo bytes, and is arranged as follows: data of start address, data of start address+1, data of start address+2, and so forth.

- Content of normal response

The contents in the normal response (a to d, including the CRC check) are the same as those in the query messages.

■ **Example) Write 0.5 s (H05) to 41007 (Pr.7) and 1 s (H0A) to 41008 (Pr.8) of slave address 25 (H19).**

Query message

Slave address	Function	Starting address		No. of registers		Byte count	Data				CRC check	
		H03	HEE	H00	H02		H04	H00	H05	H00	H0A	H86
H19 (8 bits)	H10 (8 bits)	H03 (8 bits)	HEE (8 bits)	H00 (8 bits)	H02 (8 bits)	H04 (8 bits)	H00 (8 bits)	H05 (8 bits)	H00 (8 bits)	H0A (8 bits)	H86 (8 bits)	H3D (8 bits)

Normal response (Response message)

Slave address	Function	Starting address		No. of registers		CRC check	
H19 (8 bits)	H10 (8 bits)	H03 (8 bits)	HEE (8 bits)	H00 (8 bits)	H02 (8 bits)	H22 (8 bits)	H61 (8 bits)

◆ **Read holding register access log (H46 or 70)**

- Queries by function codes H03 and H10 are supported. The number and start address of holding registers successfully accessed by the previous communication are returned. "0" is returned for both the number and start address for queries other than the function codes above.
- Query message

a. Slave address	b. Function	CRC check	
(8 bits)	H46 (8 bits)	L (8 bits)	H (8 bits)

- Normal response (Response message)

a. Slave address	b. Function	c. Starting address		d. No. of points		CRC check	
(8 bits)	H46 (8 bits)	H (8 bits)	L (8 bits)	H (8 bits)	L (8 bits)	L (8 bits)	H (8 bits)

- Query message setting

Message		Description
a	Slave address	Set the address to send messages to. Broadcast communication is not possible. (Invalid when "0" is set.)
b	Function	Set H46.

- Content of normal response

Message		Description
c	Starting address	The start address of the holding register that was successfully accessed is returned. Starting address = start register address (decimal) - 40001 For example, when starting address 0001 is returned, the holding register address that was successfully accessed is 40002.
d	No. of points	The number of holding registers that were successfully accessed is returned.

■ **Example) Read the successful register start address and number of successful accesses from slave address 25 (H19).**

Query message

Slave address	Function	CRC check	
H19 (8 bits)	H46 (8 bits)	H8B (8 bits)	HD2 (8 bits)

Normal response (Response message)

Slave address	Function	Starting address		No. of points		CRC check	
H19 (8 bits)	H10 (8 bits)	H03 (8 bits)	HEE (8 bits)	H00 (8 bits)	H02 (8 bits)	H22 (8 bits)	H61 (8 bits)

The number of holding registers that were successfully accessed was returned as two with the start address 41007 (Pr.7).

◆ **Error response**

- An error response is returned if the query message received from the master contains an illegal function, address or data. No response is returned for parity, CRC, overrun, framing, and busy errors.

## NOTE

- No response is also returned in the case of broadcast communication.

- Error response (Response message)

a. Slave address	b. Function	c. Exception code	CRC check	
(8 bits)	H80 + Function (8 bits)	(8 bits)	L (8 bits)	H (8 bits)

	Message	Description
a	Slave address	Set the address received from the master.
b	Function	The function code requested by the master and H80 is set.
c	Exception code	The codes in the following table are set.

- Error code list

Code	Error item	Error description
01	ILLEGAL FUNCTION	The query message from the master has a function code that cannot be handled by the slave.
02	ILLEGAL DATA ADDRESS*1	The query message from the master has a register address that cannot be handled by the slave. (No parameter, parameter cannot be read, parameter cannot be written)
03	ILLEGAL DATA VALUE	The query message from the master has data that cannot be handled by the slave. (Out of parameter write range, a mode is specified, or other error)

\*1 An error response is not returned in the following cases:

- (a) Function code H03 (reading data of holding registers)

When the number of registers is specified as one or more and there are one or more holding registers from which data can be read

- (b) Function code H10 (writing data to multiple holding registers)

When the number of registers is specified as one or more and there are one or more holding registers to which data can be written.

In other words, when function code H03 or H10 is used and multiple holding registers are accessed, an error response is not returned even if a nonexistent holding register or holding register that cannot be read or written from/to is accessed.

## NOTE

- An error response is returned if none of the accessed holding registers exist. When an accessed holding register does not exist, the read value is 0 and the written data is invalid.

- Error detection of message data

The following errors are detected in message data from the master. The inverter output is not shut off even if an error is detected.

Error check items

Error item	Error description	Inverter operation
Parity error	The data received by the inverter is different from the specified parity ( <b>Pr.334</b> setting).	When this error occurs, <b>Pr.343</b> is incremented by one. When this error occurs, the LF signal is output.
Framing error	The data received by the inverter is different from the stop bit length ( <b>Pr.333/Pr.334</b> ) setting.	
Overrun error	The next data has been sent by the master before the inverter completes receiving the preceding data.	
Message frame error	The data length of the message frame is checked, and an error is generated if the received data length is less than 4 bytes.	
CRC check error	An error is generated if the data in the message frame does not match the calculation result.	

## NOTE

- The LF signal can be assigned to an output terminal by setting **Pr.190 to Pr.196 (Output terminal function selection)**. Changing the terminal assignment may affect other functions. Set parameters after confirming the function of each terminal.

## ◆ MODBUS register

- The following shows the MODBUS registers for system environment variables (read/write), real time monitor items (read), parameters (read/write), fault history data (read/write), and model information monitor items (read).

- System environment variables

Register	Definition	Read/write	Remarks
40002	Inverter reset	Write	Any value
40003	Parameter clear	Write	Set H965A.
40004	All parameter clear	Write	Set H99AA.
40006	Parameter clear <sup>*1</sup>	Write	Set H5A96.
40007	All parameter clear <sup>*1</sup>	Write	Set HAA99.
40009	Inverter status / control input command <sup>*2</sup>	Read/write	Refer to the following.
40010	Operation mode / inverter setting <sup>*3</sup>	Read/write	Refer to the following.
40014	Set frequency (RAM value)	Read/write	The display can be changed to the rotations per minute using <b>Pr.37</b> , <b>Pr.144</b> and <b>Pr.811</b> . (Refer to <a href="#">page 446</a> .)
40015	Set frequency (EEPROM value)	Write	

\*1 Settings in the communication parameters are not cleared.

\*2 The data is written as a control input command for writing.  
The data is read as the inverter status for reading.

\*3 The data is written as an operation mode setting for writing.  
The data is read as the operation mode status for reading.

- Inverter status / control input command

Bit	Definition	
	Control input command	Inverter status
0	Stop command	RUN (Inverter running) <sup>*6</sup>
1	Forward rotation command	Forward running
2	Reverse rotation command	Reverse running
3	RH (High-speed operation command) <sup>*4</sup>	SU (Up to frequency) <sup>*6</sup>
4	RM (Middle-speed operation command) <sup>*4</sup>	OL (Overload warning) <sup>*6</sup>
5	RL (Low-speed operation command) <sup>*4</sup>	IPF (Instantaneous power failure/ undervoltage) <sup>*6*7</sup>
6	JOG (Jog operation selection) <sup>*4</sup>	FU (Output frequency detection) <sup>*6</sup>
7	RT (Second function selection) <sup>*4</sup>	ABC1 (Fault) <sup>*6</sup>
8	AU (Terminal 4 input selection) <sup>*4</sup>	ABC2 (-) <sup>*6</sup>
9	CS (Selection of automatic restart after instantaneous power failure / flying start) <sup>*4</sup>	Safety monitor output
10	MRS (Output stop) <sup>*4*5</sup>	0
11	STP (STOP) (Start self-holding selection) <sup>*4</sup>	0
12	RES (Inverter reset) <sup>*4</sup>	0
13	—	0
14	—	0
15	—	Fault occurrence

\*4 The signal within parentheses ( ) is the initial status. The description changes depending on the setting of **Pr.180 to Pr.189 (Input terminal function selection)** ([page 521](#)).

The signals assigned to the input terminals may be valid or invalid in the NET operation mode. (Refer to [page 404](#).)

\*5 The Inverter run enable signal is in the initial status for the separated converter type.

\*6 The signal within parentheses ( ) is the initial status. The description changes depending on the setting of **Pr.190 to Pr.196 (Output terminal function selection)** ([page 473](#)).

\*7 No function is assigned in the initial status for the separated converter type.

- Operation mode / inverter setting

Mode	Read value	Write value
EXT	H0000	H0010 <sup>*8</sup>
PU	H0001	H0011 <sup>*8</sup>
EXT JOG	H0002	—
PU JOG	H0003	—
NET	H0004	H0014
PU + EXT	H0005	—

\*8 Writing is available depending on the **Pr.79** and **Pr.340** settings. (For details, refer to [page 398](#).)  
Restrictions in each operation mode conform with the computer link specification.

- Real time monitor

Refer to [page 446](#) for the register numbers and monitor items of the real time monitor.

- Parameters

Pr.	Register	Name	Read/write	Remarks
0 to 999	41000 to 41999	For details on parameter names, refer to the parameter list ( <a href="#">page 166</a> ).	Read/write	The parameter number + +41000 is the register number.
C2 (902)	41902	Terminal 2 frequency setting bias (frequency)	Read/write	
C3 (902)	42092	Terminal 2 frequency setting bias (analog value)	Read/write	Analog value (%) set to <b>C3 (902)</b>
	43902	Terminal 2 frequency setting bias (terminal analog value)	Read	Analog value (%) of the voltage (current) applied to terminal 2
125 (903)	41903	Terminal 2 frequency setting gain (frequency)	Read/write	
C4 (903)	42093	Terminal 2 frequency setting gain (analog value)	Read/write	Analog value (%) set in <b>C4 (903)</b>
	43903	Terminal 2 frequency setting gain (terminal analog value)	Read	Analog value (%) of the voltage (current) applied to terminal 2
C5 (904)	41904	Terminal 4 frequency setting bias (frequency)	Read/write	
C6 (904)	42094	Terminal 4 frequency setting bias (analog value)	Read/write	Analog value (%) set in <b>C6 (904)</b>
	43904	Terminal 4 frequency setting bias (terminal analog value)	Read	Analog value (%) of the current (voltage) applied to terminal 4
126 (905)	41905	Terminal 4 frequency setting gain (frequency)	Read/write	
C7 (905)	42095	Terminal 4 frequency setting gain (analog value)	Read/write	Analog value (%) set in <b>C7 (905)</b>
	43905	Terminal 4 frequency setting gain (terminal analog value)	Read	Analog value (%) of the current (voltage) applied to terminal 4
C12 (917)	41917	Terminal 1 bias frequency (speed)	Read/write	
C13 (917)	42107	Terminal 1 bias (speed)	Read/write	Analog value (%) set in <b>C13 (917)</b>
	43917	Terminal 1 bias (speed) (terminal analog value)	Read	Analog value (%) of voltage applied to terminal 1
C14 (918)	41918	Terminal 1 gain frequency (speed)	Read/write	
C15 (918)	42108	Terminal 1 gain (speed)	Read/write	Analog value (%) set in <b>C15 (918)</b>
	43918	Terminal 1 gain (speed) (terminal analog value)	Read	Analog value (%) of voltage applied to terminal 1
C16 (919)	41919	Terminal 1 bias command (torque/magnetic flux)	Read/write	
C17 (919)	42109	Terminal 1 bias (torque/magnetic flux)	Read/write	Analog value (%) set to <b>C17 (919)</b>
	43919	Terminal 1 bias (torque/magnetic flux) (terminal analog value)	Read	Analog value (%) of voltage applied to terminal 1
C18 (920)	41920	Terminal 1 gain command (torque/magnetic flux)	Read/write	
C19 (920)	42110	Terminal 1 gain (torque/magnetic flux)	Read/write	Analog value (%) set to <b>C19 (920)</b>
	43920	Terminal 1 gain (torque/magnetic flux) (terminal analog value)	Read	Analog value (%) of voltage applied to terminal 1
C29 (925)	42115	Motor temperature detection calibration (analog input)	Read/write	
	43925	Motor temperature detection calibration (analog input) (terminal analog value)	Read	Analog value (%) between terminals TH1 and TH2 of the FR-A8AZ
C30 (926)	41926	Terminal 6 bias frequency (speed)	Read/write	
C31 (926)	42116	Terminal 6 bias (speed)	Read/write	Analog value (%) set in <b>C31 (926)</b>
	43926	Terminal 6 bias (speed) (terminal analog value)	Read	Analog value (%) of the voltage applied to terminal 6 of the FR-A8AZ
C32 (927)	41927	Terminal 6 gain frequency (speed)	Read/write	

Pr.	Register	Name	Read/write	Remarks
C33 (927)	42117	Terminal 6 gain (speed)	Read/write	Analog value (%) set in <b>C33 (927)</b>
	43927	Terminal 6 gain (speed) (terminal analog value)	Read	Analog value (%) of the voltage applied to terminal 6 of the FR-A8AZ
C34 (928)	41928	Terminal 6 bias command (torque)	Read/write	
C35 (928)	42118	Terminal 6 bias (torque)	Read/write	Analog value (%) set in <b>C35 (928)</b>
	43928	Terminal 6 bias (torque) (terminal analog value)	Read	Analog value (%) of the voltage applied to terminal 6 of the FR-A8AZ
C36 (929)	41929	Terminal 6 gain command (torque)	Read/write	
C37 (929)	42119	Terminal 6 gain (torque)	Read/write	Analog value (%) set in <b>C37 (929)</b>
	43929	Terminal 6 gain (torque) (terminal analog value)	Read	Analog value (%) of the voltage applied to terminal 6 of the FR-A8AZ
C8 (930)	41930	Current output bias signal	Read/write	
C9 (930)	42120	Current output bias current	Read/write	Analog value (%) set in <b>C9 (930)</b>
C10 (931)	41931	Current output gain signal	Read/write	
C11 (931)	42121	Current output gain current	Read/write	Analog value (%) set in <b>C11 (931)</b>
C38 (932)	41932	Terminal 4 bias command (torque/magnetic flux)	Read/write	
C39 (932)	42122	Terminal 4 bias (torque/magnetic flux)	Read/write	Analog value (%) set in <b>C39 (932)</b>
	43932	Terminal 4 bias (torque/magnetic flux) (terminal analog value)	Read	Analog value (%) of the current (voltage) applied to terminal 4
C40 (933)	41933	Terminal 4 gain command (torque/magnetic flux)	Read/write	
C41 (933)	42123	Terminal 4 gain (torque/magnetic flux)	Read/write	Analog value (%) set in <b>C41 (933)</b>
	43933	Terminal 4 gain (torque/magnetic flux) (terminal analog value)	Read	Analog value (%) of the current (voltage) applied to terminal 4
C42 (934)	41934	PID display bias coefficient	Read/write	
C43 (934)	42124	PID display bias analog value	Read/write	Analog value (%) set in <b>C43 (934)</b>
	43934	PID display bias analog value (terminal analog value)	Read	Analog value (%) of the current (voltage) applied to terminal 4
C44 (935)	41935	PID display gain coefficient	Read/write	
C45 (935)	42125	PID display gain analog value	Read/write	Analog value (%) set in <b>C45 (935)</b>
	43935	PID display gain analog value (terminal analog value)	Read	Analog value (%) of the current (voltage) applied to terminal 4
1000 to 1999	45000 to 45359	For details on parameter names, refer to the parameter list (page 166).	Read/write	The parameter number + 44000 is the register number.

- Fault history

Register	Definition	Read/write	Remarks
40501	Fault record 1	Read/write	Being 2 bytes in length, the data is stored as H00 $\circ\circ$ . Refer to the lowest 1 byte for the error code. (For details on error codes, refer to page 776.) The fault history is cleared by writing to register 40501. Set any value as data.
40502	Fault record 2	Read	
40503	Fault record 3	Read	
40504	Fault record 4	Read	
40505	Fault record 5	Read	
40506	Fault record 6	Read	
40507	Fault record 7	Read	
40508	Fault record 8	Read	

- Product profile

Register	Definition	Read/write	Remarks
44001	Model (1st and 2nd characters)	Read	The inverter model can be read in ASCII code. "H20" (blank code) is set for blank area. Example) FR-A840-1 (FM type): H46, H52, H2D, H41, H38, H34, H30, H2D, H31, H20.....H20
44002	Model (3rd and 4th characters)	Read	
44003	Model (5th and 6th characters)	Read	
44004	Model (7th and 8th characters)	Read	
44005	Model (9th and 10th characters)	Read	
44006	Model (11th and 12th characters)	Read	
44007	Model (13th and 14th characters)	Read	
44008	Model (15th and 16th characters)	Read	
44009	Model (17th and 18th characters)	Read	
44010	Model (19th and 20th characters)	Read	
44011	Capacity (1st and 2nd characters)	Read	The capacity in the inverter model can be read in ASCII code. Data is read in increments of 0.1 kW, and rounds down to 0.01 kW increments. "H20" (blank code) is set for blank area. Example) 0.75K: " 7" (H20, H20, H20, H20, H20, H37)
44012	Capacity (3rd and 4th characters)	Read	
44013	Capacity (5th and 6th characters)	Read	

### NOTE

- When a 32-bit parameter setting or monitor item is read and the value to be read exceeds HFFFF, HFFFF is returned.

## ◆ Pr.343 Communication error count

- The communication error occurrence count can be checked.

Parameter	Setting range	Minimum setting range	Initial value
343	(Read-only)	1	0

### NOTE

- The communication error count is temporarily stored in the RAM memory. The value is not stored in EEPROM, and so is cleared to 0 when power is reset and the inverter is reset.

## ◆ Alarm (LF) signal output (communication error warning)

- During a communication error, the Alarm (LF) signal is output by open collector output. Assign the terminal to be used using any of **Pr.190 to Pr.196 (Output terminal function selection)**.

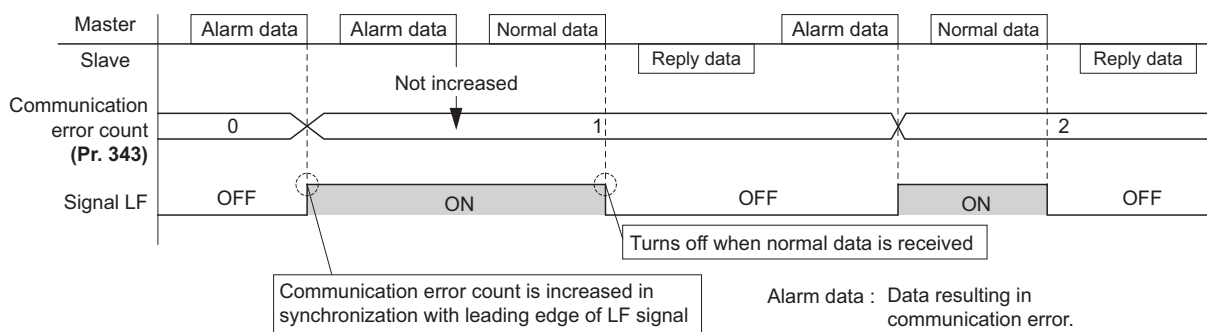

### NOTE

- The LF signal can be assigned to an output terminal by setting **Pr.190 to Pr.196**. Changing the terminal assignment may affect other functions. Set parameters after confirming the function of each terminal.

## ◆ Signal loss detection (Pr.539 RS-485 communication check time interval)

- If a signal loss (communication) is detected between the inverter and the master as a result of a signal loss detection, the Communication fault (inverter) (E.SER) occurs and the inverter output is shut off.
- When the setting is "9999", communication check (signal loss detection) is not made.
- When the setting is "0", reading, etc. of monitors and parameters is possible, though E.SER occurs instantly when the operation mode is switched to the Network operation.

- A signal loss detection is made when the setting is any of "0.1 s to 999.8 s". In order to enable the signal loss detection, data must be sent by the master at an interval equal to or less than the time set for the communication check. (The inverter makes a communication check (clearing of communication check counter) regardless of the station number setting of the data sent from the master).
  - The communication check is made from the first communication in the Network operation mode (can be changed by **Pr.551 PU mode operation command source selection**).
  - The communication check time by query communication includes a no-data time (3.5 bytes).
- This no-data time differs according to the communication speed, so take this no-data time into consideration when setting the communication check time.

Example: RS-485 terminal communication, **Pr. 539** = "0.1 to 999.8 s"

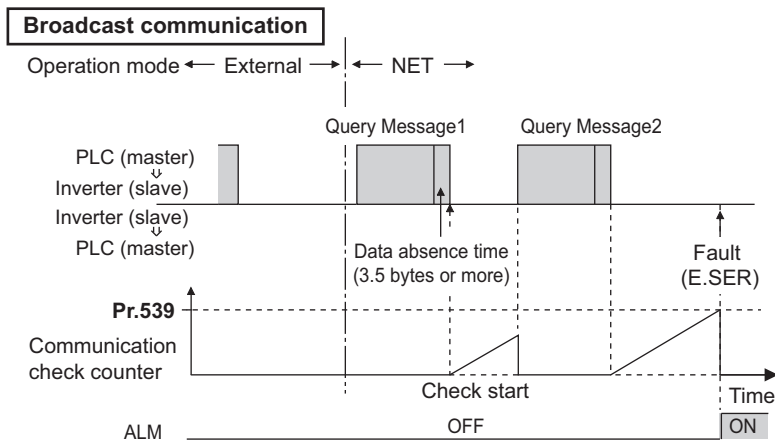
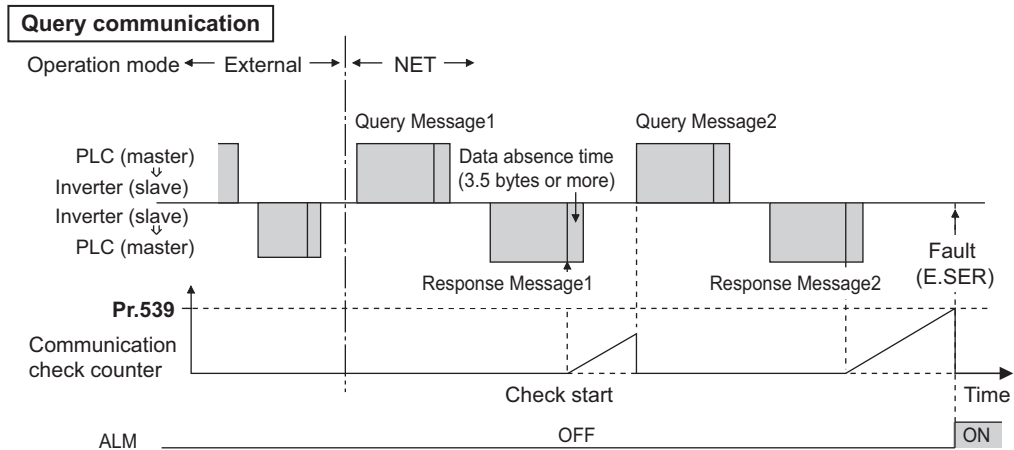

#### NOTE

- For the RS-485 terminal communication, the operation at a communication error occurrence depends on the **Pr.502 Stop mode selection at communication error** setting. (Refer to [page 663](#).)

## 5.15.7 CC-Link IE Field Network function setting (FR-A800-GF)

Use the following parameters to perform required settings for CC-Link IE Field Network communication between the inverter and other stations.

- For details on the CC-Link IE Field Network, refer to [page 752](#).
- For the inverter operation at communication error, refer to [page 663](#).
- Set the parameters other than **Pr.434**, **Pr.435**, and **Pr.541** in the same way as when a communication option is used.



Pr.	Name	Initial value	Setting range	Description
434 N110	Network number (CC-Link IE)	0	0 to 255	Enter the network number of the inverter.
435 N111	Station number (CC-Link IE)	0	0 to 255	Enter the station number of the inverter.
541 N100	Frequency command sign selection	0	0	Signed frequency command value
			1	Unsigned frequency command value

### ◆ Network number and station number setting (Pr.434, Pr.435)

- Enter the inverter network number in **Pr.434 Network number (CC-Link IE)**.
- The setting range of **Pr.434** is "0 to 255", but its active range is "1 to 239". The values out of the active range are invalid because such values cannot be transmitted to the master station.
- Use **Pr.435 Station number (CC-Link IE)** to enter the station number of the inverter.
- The setting range of **Pr.435** is "0 to 255", but its active range is "1 to 120". The values out of the active range are invalid because such values cannot be transmitted to the master station.

#### NOTE

- Use different station numbers for different devices. (If different devices have the same station number, the communication cannot be performed properly. If an error occurs due to a duplicated number, re-assign the station numbers, then reset the master station and the inverter power.)
- Station numbers do not have to be consecutive numbers.
- The **Pr.434** and **Pr.435** settings are applied after an inverter reset or next power-ON.

### ◆ Frequency command with sign (Pr.541)

- By adding a sign to the frequency command value, the start command (forward/reverse rotation) can be inverted to start operation
- The **Pr.541 Frequency command sign selection** setting is applied to the frequency command from RWw0.

Rotations per minute (machine speed) setting using Pr.37 and Pr.144	Pr.541 setting	Sign	Setting range	Actual frequency command
Without	0	Without	0 to 59000	0 to 590.00 Hz
	1	With	-32768 to 32767 (two's complement)	-327.68 to 327.67 Hz
With	0	Without	0 to 65535	It depends on <b>Pr.37</b> , <b>Pr.144</b> , and <b>Pr.811</b> settings (in 1 or 0.1 increments).
	1	With	-32768 to 32767 (two's complement)	

- Relationship between the start command and sign (**Pr.541** = "1")

Start command	Sign of the frequency command	Actual operation command
Forward rotation	+	Forward rotation
	-	Reverse rotation
Reverse rotation	+	Forward rotation
	-	Reverse rotation

#### NOTE

- When **Pr.541** = "1" (with sign)
  - When EEPROM write is specified by turning ON of RY22, write mode error (error code H01) will occur.
  - When both RY21 and RY22 are turned ON, RY21 has precedence.
  - When power is turned ON (inverter reset), the initial setting status of the sign bit is "positive" and the set frequency is 0 Hz. (The motor does not operate at the frequency set before turning OFF the power (inverter reset).)
  - When set frequency is written with the instruction code of HED or HEE, the sign of the frequency command is not changed.

#### ◀ Parameters referred to ▶

Pr.37 Speed display, Pr.144 Speed setting switchover, Pr.811 Set resolution switchover [page 444](#)

## 5.15.8 USB device communication

A personal computer and an inverter can be connected with a USB cable. Setup of the inverter can be easily performed with FR Configurator2.

The inverter can be connected easily to a personal computer by a USB cable.

Pr.	Name	Initial value	Setting range	Description
547*1 N040	USB communication station number	0	0 to 31	Specify the inverter station number.
548*1 N041	USB communication check time interval	9999	0	USB communication is possible, however the inverter output is shut off (E.USB) when the mode changes to the PU operation mode.
			0.1 to 999.8 s	Set the communication check time interval. If a no-communication state persists for longer than the permissible time, the inverter output is shut off (E.USB).
			9999	No communication check

\*1 The changed value is applied after the next power-ON or inverter reset.

### ◆ USB communication specifications

Interface	Conforms to USB 1.1 (USB 2.0 full speed)
Transmission speed	12 Mbps
Wiring length	Maximum 5 m
Connector	USB mini B connector (receptacle)
Power supply	Self-powered
Recommended USB cable	MR-J3USBCBL3M (cable length 3 m)

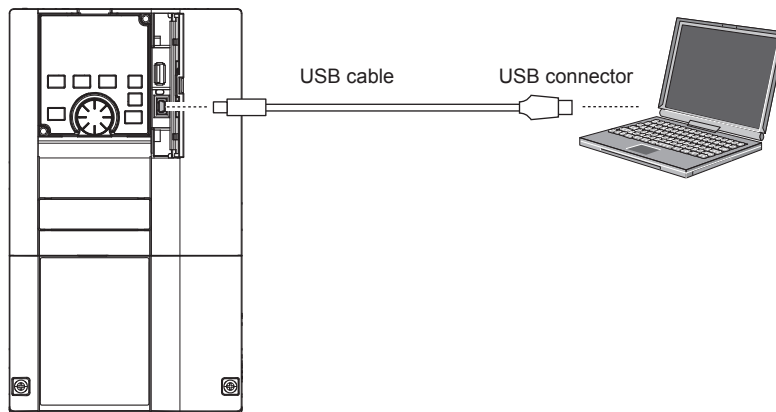

- At the initial setting (**Pr.551 PU mode operation command source selection** = "9999"), communication with FR Configurator2 can be made in the PU operation mode simply by connecting a USB cable. To fix the command source to the USB connector in the PU operation mode, set "3" in **Pr.551**.
- Parameter setting and monitoring can be performed by using FR Configurator2. For details, refer to the Instruction Manual of FR Configurator2.

#### ◀ Parameters referred to ▶

**Pr.551 PU mode operation command source selection** page 400

## 5.15.9 Automatic connection with GOT

When the automatic connection is enabled in the GOT2000 series, the inverter can communicate with the GOT2000 series with only setting the station number and connecting the GOT. This eliminates the need for the communication parameter setting.

Pr.	Name	Initial value	Setting range	Description
117 N020	PU communication station number	0	0 to 31	Use this parameter to specify the inverter station number. The inverter station number setting is required when multiple inverters are connected to one GOT (PU connector communication).
331 N030	RS-485 communication station number	0	0 to 31 (0 to 247) <sup>*1*2</sup>	Specify the inverter station number. The inverter station number setting is required when multiple inverters are connected to one GOT (RS-485 terminal communication).

\*1 When Pr.549 Protocol selection = "1" (MODBUS RTU protocol), the setting range is as shown in the parentheses.

\*2 When a value outside the setting range is set, the inverter operates at the initial value.

## ◆ Automatic connection system configuration

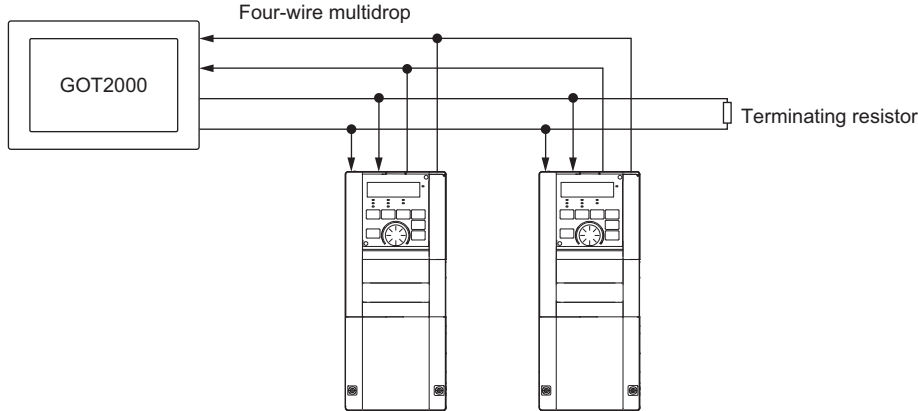

## ◆ GOT2000 series automatic recognition

- When the GOT2000 series is connected, the parameters required for the GOT connection are automatically changed by setting the automatic recognition on the GOT2000 series side.
- Set the station number (Pr.117 or Pr.331) of the inverter before the automatic recognition is performed.
- Connect all the stations of inverters with GOT before the automatic recognition is performed. The inverter newly added after automatic recognition will not be recognized automatically. (When an inverter is added, perform the initial setting in Pr.999 Automatic parameter setting or set the automatic recognition on the GOT side again.)

Automatic change item	Automatic change parameter		Setting value after change
	PU connector connection	RS-485 terminal connection	
Communication speed	Pr.118	Pr.332	Depending on the setting of the connected device on the GOT side.
Data length / stop bit	Pr.119	Pr.333	
Parity	Pr.120	Pr.334	
Time delay setting	Pr.123	Pr.337	
CR/LF selection	Pr.124	Pr.341	
Number of communication retries	Pr.121	Pr.335	9999 (fixed)
Communication check time interval	Pr.122	Pr.336	9999 (fixed)
Protocol selection	(Pr.549 holds the value before the automatic recognition.)	Pr.549	0 (fixed to Mitsubishi inverter protocol)

### NOTE

- If the automatic recognition cannot be performed, initial setting in Pr.999 is required.
- For connection to a device other than the GOT2000 series, initial setting in Pr.999 is required.
- For details, refer to the GOT2000 Series Connection Manual (Mitsubishi Product).

### Parameters referred to

Pr.999 Automatic parameter setting page 350

## 5.15.10 Backup/restore

The GOT can be used for backing up inverter parameters and the data used in the PLC function of inverter.

The backup data stored in the GOT can be used to restore the data in the inverter.

Pr.	Name	Initial value	Setting range	Description
434 N110 <sup>*1</sup>	Network number (CC-Link IE)	0	0 to 255	Enter the network number of the inverter.
435 N111 <sup>*1</sup>	Station number (CC-Link IE)	0	0 to 255	Enter the station number of the inverter.

\*1 The setting is available in the inverter on which the FR-A8NCE is installed or when the FR-A800-GF inverter is used.

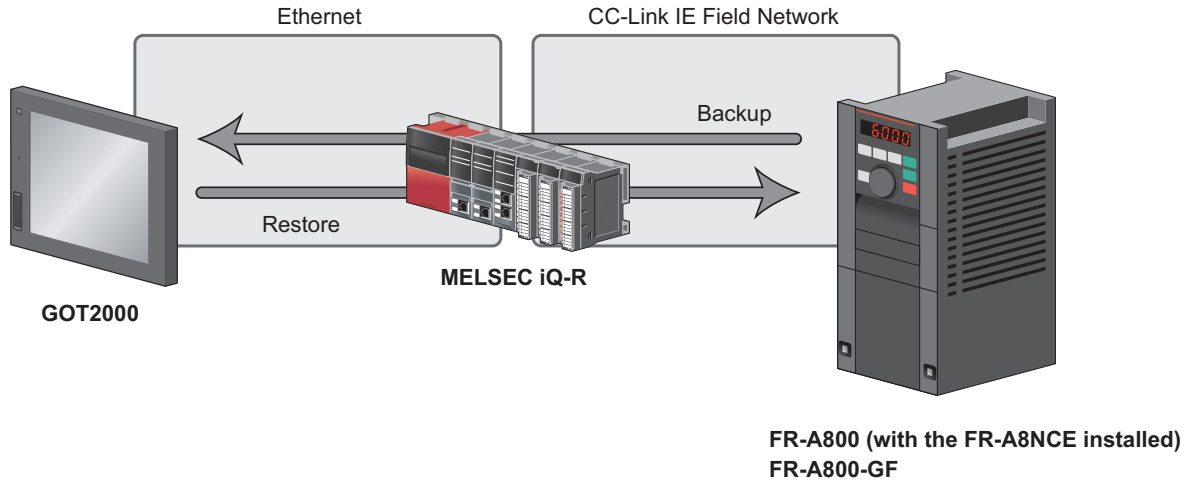

## ◆ Connected devices

- To enable backup/restore, connect either the general-purpose inverter with the FR-A8NCE or the FR-A800-GF inverter to a programmable controller (master station) via the CC-Link IE Field Network.

### NOTE

- The backup/restore function is enabled only when the inverter is connected to a master station programmable controller.
- For details on the connected devices, refer to the GOT2000 Series User's Manual (Monitor).

## ◆ Data to be backed up and restored

- The following data can be backed up and restored. The data other than those listed in the following table cannot be backed up or restored.

Item
Inverter parameters
Parameters used for activating the PLC function
Programs (including SFCs) used in the PLC function
Global device comment information used in the PLC function
Function block source information

## ◆ Backup/restore operation

- The GOT backs up all applicable data in all the inverters that can be identified with the network numbers and station numbers in the controller list file.
- The GOT restores all relevant data of the inverters selected based on the network numbers and station numbers using the backup data.
- The backup/restore cannot be performed in the following cases.

Operation	Inverter status
Backup	During an inverter reset A password is registered or password protection is enabled ( <b>Pr.297</b> ≠ "9999"). During parameter copy using an operation panel or USB memory device (during writing to the inverter) During restore While password protection is enabled for files used in the PLC function (read protection) While PLC function project data is written to, read from, or verified against a USB memory device
Restore	During an inverter reset During running During auto tuning A password is registered or password protection is enabled ( <b>Pr.297</b> ≠ "9999"). While parameter write is disabled ( <b>Pr.77</b> = "1") During parameter copy using an operation panel or USB memory device (during writing to / reading from / verification against the inverter) During backup operation During the RUN status of the PLC function While password protection is enabled for files used in the PLC function (write protection) While PLC function project data is written to, read from, or verified against a USB memory device

- On the operation panel, "RD" is displayed during backup, and "WR" is displayed during restore.

### NOTE

- To enable the restore operation, **Pr.434 Network number (CC-Link IE)** and **Pr.435 Station number (CC-Link IE)** must be set.
- Backup is performed for parameters for which parameter copy can be performed.
- For details on backup/restore function, refer to the GOT2000 Series User's Manual (Monitor).

# 5.16 (G) Control parameters

Purpose	Parameter to set			Refer to page
To set the starting torque manually	Manual torque boost	P.G000 to P.G010, P.G020	Pr.0 to Pr.46, Pr.112	706
To set the motor constant	Base frequency, base frequency voltage	P.G001, P.G002, P.G011, P.G021	Pr.3, Pr.19, Pr.47, Pr.113	707
To select the V/F pattern matching the application	Load pattern selection	P.G003	Pr.14	708
To improve the torque in a low-speed range	Excitation current low-speed scaling factor	P.G003, P.G080, P.G201, P.G202, P.G301, P.G302	Pr.14, Pr.85, Pr.86, Pr.565, Pr.566, Pr.617	711
To perform energy saving operation	Energy saving operation	P.G030	Pr.60	712
To use a special motor	Adjustable 5 points V/F	P.C100, P.G040 to P.G049	Pr.71, Pr.100 to Pr.109	713
To compensate the motor slip amount when replacing an SF-JR motor with an SF-PR motor	SF-PR slip amount adjustment mode	P.G060, P.G061	Pr.673, Pr.674	714
To adjust the motor braking torque	DC injection brake, zero speed control, servo lock, magnetic flux decay output shutoff	P.G100 to P.G103, P.G108 to P.G110	Pr.10 to Pr.12, Pr.802, Pr.850, Pr.1299	715
To coast the motor to a stop	Output stop function	P.G105	Pr.522	720
	Selection of motor stop method	P.G106	Pr.250	722
To use the regeneration unit to increase the motor braking torque	Regenerative brake selection	P.E300 to P.G107, P.T721	Pr.30, Pr.70, Pr.599	724
To operate the inverter with DC power supply	DC feeding mode	P.E300	Pr.30	724
To avoid overvoltage fault due to regenerative driving by automatic adjustment of output frequency	Regeneration avoidance function	P.G120 to P.G125	Pr.882 to Pr.886, Pr.665	732
To decrease the deceleration time of the motor	Increased magnetic excitation deceleration	P.G130 to P.G132	Pr.660 to Pr.662	735
To select the control method	Control method selection	P.G200, P.G300	Pr.800, Pr.451	221
To secure the low-speed torque by compensating the slip of the motor	Slip compensation	P.G203 to P.G205	Pr.245 to Pr.247	736
To select the torque characteristic	Constant output range torque characteristic selection	P.G210	Pr.803	245, 283
To adjust the speed control gain	Speed control gain	P.G211, P.G212, P.G311, P.G312	Pr.820, Pr.821, Pr.830, Pr.831	254
To adjust the torque control gain	Torque control gain	P.G213, P.G214, P.G313, P.G314	Pr.824, P.825, Pr.834, P.835	294
To stabilize speed and torque feedback signal	Speed detection filter, torque detection filter	P.G215, P.G216, P.G315, P.G316	Pr.823, Pr.827, Pr.833, Pr.837	332
To change excitation ratio	Excitation ratio	P.G217	Pr.854	332
To improve the motor trackability for the speed command changes	Speed feed forward control, model adaptive speed control	P.G224, P.G220 to P.G222, P.G223	Pr.828, Pr.877 to Pr.879, Pr.881	263
To make starting torque start-up faster	Torque bias	P.G230 to P.G238	Pr.840 to Pr.848	265
To make the motor speed constant by the encoder	Encoder feedback control	P.M002, P.A107, P.C140, P.C141, P.G240, P.G241	Pr.144, Pr.285, Pr.359, Pr.367 to Pr.369	736
To select low-speed range torque characteristics	Low-speed range torque characteristics	P.G250, P.G350	Pr.788, Pr.747	233
To select operation at emergency stop	Emergency stop operation selection	P.G264	Pr.1349	367
To perform frequency control appropriate for load torque	Droop control	P.G400 to P.G404, P.G420 to P.G424	Pr.286 to Pr.288, Pr.679 to Pr.683, Pr.994, Pr.995	738
To suppress the machine resonance	Speed smoothing control	P.G410, P.G411	Pr.653, Pr.654	741
	Notch filter	P.G601 to P.G603	Pr.1003 to Pr.1005	271
To adjust the speed gain for Advanced magnetic flux vector control	Speed control gain	P.G932, P.G942	Pr.89, Pr.569	228

## 5.16.1 Manual torque boost



Voltage drop in the low-frequency range can be compensated, improving reduction of the motor torque in the low-speed range.

- Motor torque in the low-frequency range can be adjusted according to the load, increasing the motor torque at the start up.
- By using the RT signal or X9 signal, it is possible to switch between 3 types of torque boost.

Pr.	Name	Initial value	Setting range	Description
0 G000	Torque boost	6% <sup>*1</sup>	0 to 30%	Set the output voltage at 0 Hz in %.
		4% <sup>*2</sup>		
		3% <sup>*3</sup>		
		2% <sup>*4</sup>		
		1% <sup>*5</sup>		
46 G010	Second torque boost	9999	0 to 30%	Set the torque boost value at when the RT signal is ON.
			9999	Without the second torque boost
112 G020	Third torque boost	9999	0 to 30%	Set the torque boost value at when the X9 signal is ON.
			9999	Without the third torque boost

\*1 The initial value for the FR-A820-00077(0.75K) or lower and FR-A840-00038(0.75K) or lower.

\*2 The initial value for the FR-A820-00105(1.5K) to FR-A820-00250(3.7K), FR-A840-00052(1.5K) to FR-A840-00126(3.7K).

\*3 The initial values for the FR-A820-00340(5.5K), FR-A820-00490(7.5K), FR-A840-00170(5.5K), FR-A840-00250(7.5K).

\*4 The initial value for the FR-A820-00630(11K) to FR-A820-03160(55K), FR-A840-00310(11K) to FR-A840-01800(55K).

\*5 The initial value for the FR-A820-03800(75K) or higher and FR-A840-02160(75K) and higher.

### ◆ Starting torque adjustment

- Assuming **Pr.19 Base frequency voltage** is 100%, set the output voltage at 0 Hz to **Pr.0 (Pr.46, Pr.112)** in percentage.
- Perform the adjustment of the parameter little by little (approximately 0.5%), and confirm the status of the motor each time. The motor may overheat when the value is set too high. Do not use more than 10% as a guideline.

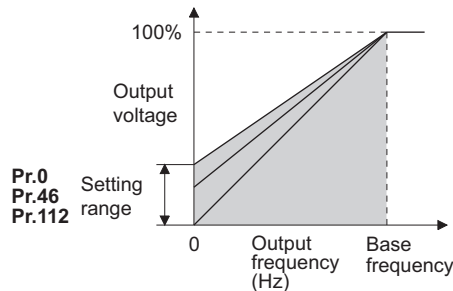

### ◆ Setting multiple torque boosts (RT signal, X9 signal, Pr.46, Pr.112)

- When changing the torque boost depending on the application or when using single inverter switching between multiple motors, use the second (third) torque boost.
- **Pr.46 Second torque boost** is enabled when the RT signal is ON.
- **Pr.112 Third torque boost** is enabled when the X9 signal is ON. Set "9" in **Pr.178 to Pr.189 (Input terminal function selection)** to assign the X9 signal function to a terminal.

#### NOTE

- The RT (X9) signal acts as the second (third) function selection signal and makes the other second (third) functions valid. (Refer to [page 525](#).)
- The RT signal is assigned to the terminal RT in the initial status. Set "3" in one of **Pr.178 to Pr.189 (Input terminal function selection)** to assign the RT signal to another terminal.
- Set a larger value when the distance between the inverter and the motor is long or when there is not enough motor torque in the low-speed range. It may cause overcurrent trip when it is set too large.
- Setting for **Pr.0, Pr.46,** and Pr.112 becomes enabled only when the V/F control is selected.
- When the initial value is set in **Pr.0**, the **Pr.0** setting is automatically changed by changing the **Pr.71 Applied motor** or **Pr.81 Number of motor poles** setting. (Refer to [page 528](#).)
- Changing the terminal assignment using **Pr.178 to Pr.189 (Input terminal function selection)** may affect the other functions. Set parameters after confirming the function of each terminal.

Parameters referred to

Pr.3 Base frequency, Pr.19 Base frequency voltage page 707

Pr.71 Applied motor page 528

Pr.178 to Pr.189 (Input terminal function selection) page 521

## 5.16.2 Base frequency voltage



Use this function to adjust the inverter outputs (voltage, frequency) to match with the motor rating.

Pr.	Name	Initial value		Setting range	Description
		FM	CA		
3 G001	Base frequency	60 Hz	50 Hz	0 to 590 Hz	Set the frequency at the rated motor torque. (50/60 Hz)
19 G002	Base frequency voltage	9999	8888	0 to 1000 V	Set the base voltage.
				8888	95% of the power supply voltage
				9999	Same as the power supply voltage
47 G011	Second V/F (base frequency)	9999		0 to 590 Hz	Set the base frequency when the RL signal is ON.
				9999	Second V/F disabled
113 G021	Third V/F (base frequency)	9999		0 to 590 Hz	Set the base frequency when the X9 signal is ON.
				9999	Third V/F disabled

### ◆ Base frequency setting (Pr.3)

- When operating a standard motor, generally set the rated frequency of the motor in **Pr.3 Base frequency**. When the motor operation require switching to the commercial power supply, set the power supply frequency in **Pr.3**.
- When the frequency described on the motor rating plate is "50 Hz" only, make sure to set to 50 Hz. When it is set to 60 Hz, the voltage will drop too much, causing insufficient torque. As a result, the inverter output may be shut off due to overload. A caution is required especially in case of **Pr.14 Load pattern selection = "1"** (variable torque load).
- When using the Mitsubishi Electric constant torque motor, set **Pr.3** to 60 Hz.

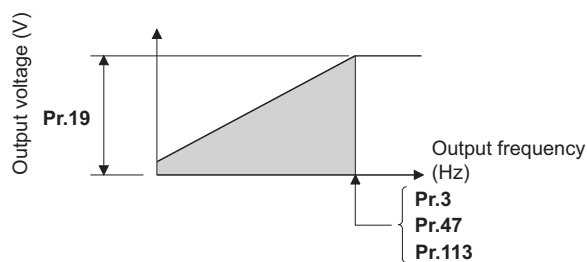

### ◆ Setting multiple base frequencies (Pr.47, Pr.113)

- To change the base frequency when using a single inverter switching between multiple motors, use **Pr.47 Second V/F (base frequency)** and Pr.113 Third V/F (base frequency).
- Pr.47** is enabled when the RT signal is ON and **Pr.113** is enabled when the X9 signal is ON. To input the X9 signal, set "9" in any of **Pr.178 to Pr.189 (Input terminal function selection)** to assign the function to a terminal.

#### NOTE

- The RT (X9) signal acts as the second (third) function selection signal and makes the other second (third) functions valid. (Refer to page 525.)
- The RT signal is assigned to the terminal RT in the initial status. Set "3" in one of **Pr.178 to Pr.189 (Input terminal function selection)** to assign the RT signal to another terminal.

### ◆ Setting of base frequency voltage (Pr.19)

- Use **Pr.19 Base frequency voltage** to set the base voltage (for example, rated motor voltage).
- When it is set lower than the power supply voltage, maximum output voltage of the inverter will be the voltage set in **Pr.19**.



- **Pr.19** can be used in following cases.
  - (a) When regenerative driving (continuous regeneration, etc.) is performed frequently  
Output voltage will get higher than the specification during the regenerative driving, which may cause overcurrent trip (E.OC[]) by the increase in motor current.
  - (b) When the fluctuation of power supply voltage is high  
When the power supply voltage exceeds the rated voltage of the motor, fluctuation of rotation speed or overheating of motor may occur due to excessive torque or increase in motor current.
- When operating a Vector control dedicated motor (SF-V5RU, SF-V5RU1, SF-V5RU3, SF-V5RU4, SF-VR) with V/F control, perform following settings.

Motor model	Pr.19 setting	Pr.3 setting
SF-V5RU, 3.7 kW or lower	170 V	50 Hz
SF-V5RU, 5.5 kW or higher	160 V	
SF-V5RUH, 3.7 kW or lower	340 V	
SF-V5RUH, 5.5 kW or higher	320 V	
SF-V5RU1, 30 kW or lower	160 V	33.33 Hz
SF-V5RU1, 37 kW	170 V	
SF-V5RU3, 22 kW or lower	160 V	
SF-V5RU3, 30 kW	170 V	16.67 Hz
SF-V5RU4, 3.7 kW and 7.5 kW	150 V	
SF-V5RU4 and motors other than described above	160 V	50 Hz
SF-VR	160 V	
SF-VRH	320 V	

#### NOTE

- When the operation becomes not possible due to failure in encoder, etc., under Vector control, set **Pr.80 Motor capacity** or **Pr.81 Number of motor poles** = "9999" to perform V/F control.
- When the Advanced magnetic flux vector control, Real sensorless vector control, Vector control, or PM sensorless vector control is selected, **Pr.3**, **Pr.47**, **Pr.113**, and **Pr.19** will become disabled, and **Pr.83** and **Pr.84** will become enabled. However, S-pattern curve with **Pr.29 Acceleration/deceleration pattern selection** = "1" (S-pattern acceleration/deceleration A) will make **Pr.3** or **Pr.47** and **Pr.113** enabled. (S-pattern curve under PM sensorless vector control is the rated frequency of the motor.)
- When **Pr.71 Applied motor** = "2" (adjustable 5 points V/F), setting for **Pr.47** and **Pr.113** will become disabled. Also, **Pr.19** cannot be set to "8888" or "9999".
- Changing the terminal assignment using **Pr.178 to Pr.189 (Input terminal function selection)** may affect the other functions. Set parameters after confirming the function of each terminal.

#### Parameters referred to

Pr.14 Load pattern selection [page 708](#)

Pr.29 Acceleration/deceleration pattern selection [page 372](#)

Pr.71 Applied motor [page 528](#)

Pr.83 Rated motor voltage, Pr.84 Rated motor frequency [page 532](#)

Pr.178 to Pr.189 (Input terminal function selection) [page 521](#)

## 5.16.3 Load pattern selection



Optimal output characteristics (V/F characteristics) for application or load characteristics can be selected.

Pr.	Name	Initial value	Setting range	Description
14 G003	Load pattern selection	0	0	For constant-torque load
			1	For variable-torque load
			2	For constant-torque lift (boost at reverse rotation: 0%)
			3	For constant-torque lift (boost at forward rotation: 0%)
			4	RT signal ON... for constant-torque load, RT signal OFF... for constant-torque lift, boost at reverse rotation 0%
			5	RT signal ON... for constant-torque load, RT signal OFF... for constant-torque lift, boost at forward rotation 0%
			12 to 15	Excitation current low-speed scaling factor (Refer to <a href="#">page 711.</a> )

## ◆ Application for constant-torque load (Pr.14 ="0", initial value)

- The output voltage will change linearly against the output frequency at the base frequency or lower.
- Set this parameter when driving a load that has constant load torque even when the rotation speed is changed, such as conveyor, dolly, or roll drive.

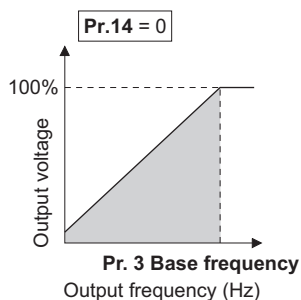

### Point

Select for constant-torque load (setting value "0") even for fan and pump in following cases.

- When accelerating a blower with large moment of inertia (J) in a short period of time.
- When it is a constant-torque load such as rotary pump or gear pump.
- When the load torque increases in low speed such as screw pump.

## ◆ Application for variable-torque load (Pr.14 ="1")

- The output voltage will change in square curve against the output frequency at the base frequency or lower. (1.75th-power curve for the FR-A820-01870(37K) or higher, and the FR-A840-00930(37K) or higher)
- Set this parameter when driving a load with load torque change proportionally against the square of the rotation speed, such as a fan or pump.

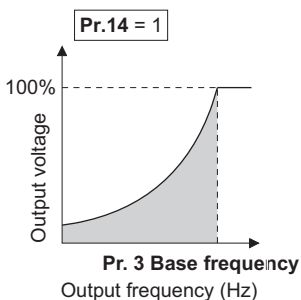

## ◆ Vertical lift load applications (Pr.14 = "2, 3")

- Set "2" when a vertical lift load is fixed as power driving load at forward rotation and regenerative load at reverse rotation.
- **Pr.0 Torque boost** is valid during forward rotation, and torque boost is automatically changed to "0%" during reverse rotation.
- Set "3" for an elevated load that is in the driving mode during reverse rotation and in the regenerative load mode during forward rotation according to the load weight, e.g. counterweight system.

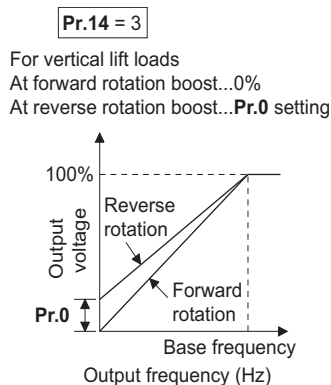
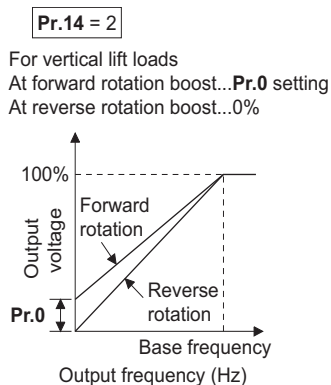

**NOTE**

- When torque is continuously regenerated as vertical lift load, it is effective to set the rated voltage in **Pr.19 Base frequency voltage** to prevent trip due to current at regeneration.

**◆ Switching load pattern using signal (Pr.14 = "4, 5")**

- The output characteristics can be switched between for constant-torque load and for lift with the RT signal or X17 signal.
- To input the X17 signal, set "17" in any of **Pr.178 to Pr.189 (Input terminal function selection)** to assign the function.
- Switching with the RT signal will become disabled when the X17 signal is assigned.

Pr.14 setting	RT (X17) signal	Output characteristics
4	ON	For constant-torque load (same as setting value "0")
	OFF	For lift, boost at reverse rotation 0% (same as setting value "2")
5	ON	For constant-torque load (same as setting value "0")
	OFF	For lift, boost at forward rotation 0% (same as setting value "3")

**NOTE**

- The RT signal is assigned to the terminal RT in the initial status. Set "3" in one of **Pr.178 to Pr.189 (Input terminal function selection)** to assign the RT signal to another terminal.
- Changing the terminal assignment using **Pr.178 to 189** may affect other functions. Set parameters after confirming the function of each terminal.
- **Pr.14** will become enabled under V/F control.
- Other second functions will become enabled when the RT signal is ON.

**Parameters referred to**Pr.0 Torque boost [page 706](#)Pr.3 Base frequency [page 707](#)Pr.178 to Pr.189 (Input terminal function selection) [page 521](#)

## 5.16.4 Excitation current low-speed scaling factor

Magnetic flux Sensorless

Under Advanced magnetic flux vector control or Real sensorless vector control, the excitation current scaling factor in the low-speed range can be adjusted.

Pr.	Name	Initial value	Setting range	Description
14 G003	Load pattern selection	0	0 to 5	Excitation current low-speed scaling factor: <b>Pr.86</b> Refer to <a href="#">page 708</a> for details on the operation under V/F control.
			12 <sup>*1</sup>	Forward rotation excitation current low-speed scaling factor: <b>Pr.86</b> Reverse rotation excitation current low-speed scaling factor: <b>Pr.617</b>
			13 <sup>*1</sup>	Forward rotation excitation current low-speed scaling factor: <b>Pr.617</b> Reverse rotation excitation current low-speed scaling factor: <b>Pr.86</b>
			14 <sup>*1</sup>	Forward rotation excitation current low-speed scaling factor: <b>Pr.86</b> Reverse rotation excitation current low-speed scaling factor: <b>Pr.617</b> (X17-OFF), <b>Pr.86</b> (X17 signal-ON)
			15 <sup>*1</sup>	Forward rotation excitation current low-speed scaling factor: <b>Pr.617</b> (X17-OFF), <b>Pr.86</b> (X17 signal-ON) Reverse rotation excitation current low-speed scaling factor: <b>Pr.86</b>
85 G201	Excitation current break point	9999	0 to 400 Hz	Set the frequency at which increased excitation is started.
			9999	SF-PR/SF-HR/SF-HRCA motor: The predetermined frequency is applied. Motor other than the above: 10 Hz is applied.
86 G202	Excitation current low-speed scaling factor	9999	0 to 300%	Set an excitation current scaling factor at 0 Hz.
			9999	SF-PR/SF-HR/SF-HRCA motor: The predetermined scaling factor is applied. Motor other than the above: 130% is applied.
617 G080	Reverse rotation excitation current low-speed scaling factor	9999	0 to 300%	Set an excitation current scaling factor when different excitation current scaling factors are used for forward and reverse rotation.
			9999	SF-PR/SF-HR/SF-HRCA motor: The predetermined scaling factor is applied. Motor other than the above: 130% is applied.
565 G301	Second motor excitation current break point	9999	0 to 400 Hz	Set an excitation current break point when the RT signal is ON.
			9999	SF-PR/SF-HR/SF-HRCA motor: The predetermined frequency is applied. Motor other than the above: 10 Hz is applied.
566 G302	Second motor excitation current low-speed scaling factor	9999	0 to 300%	Set an excitation current low-speed scaling factor when the RT signal is ON.
			9999	SF-PR/SF-HR/SF-HRCA motor: The predetermined scaling factor is applied. Motor other than the above: 130% is applied.

\*1 The setting is valid only under Advanced magnetic flux vector control or Real sensorless vector control. When **Pr.14** = "12 to 15" and V/F control is selected, the operation is the same as the one for constant-torque load (**Pr.14** = "0"). (Refer to [page 708](#).)

- Under Advanced magnetic flux vector control or Real sensorless vector control, excitation current in the low-speed range can be increased to improve torque. When **Pr.14** = "12 to 15", the excitation current scaling factor can be switched for the forward/reverse rotation.
- Increased excitation is applied when the output frequency is equal to or lower than the setting in **Pr.85 Excitation current break point**. The excitation current scaling factor at 0 Hz is set in **Pr.86 Excitation current low-speed scaling factor**. Use **Pr.565 Second motor excitation current break point** and **Pr.566 Second motor excitation current low-speed scaling factor** for the setting for using the second motor (RT signal-ON).

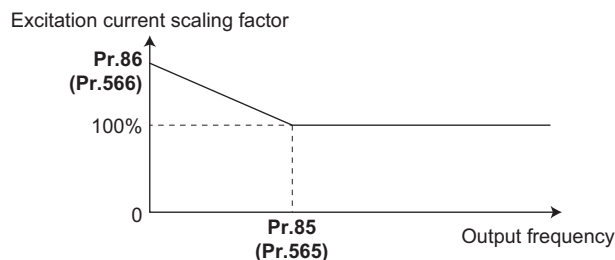

- When **Pr.14** = "14 or 15" and the X17 signal is turned ON, the excitation current scaling factor is switched from the value set in **Pr.617** to the value set in **Pr.86**.

- An excitation current low-speed scaling factor set in the parameter shown in the table is used according to the **Pr.14** setting and other conditions.

Pr.14 setting	X17 signal	During forward rotation		During reverse rotation	
		RT signal OFF	RT signal ON	RT signal OFF	RT signal ON
0 to 5	—	Pr.86	Pr.566	Pr.86	Pr.566
12	—	Pr.86	Pr.566	Pr.617	Pr.617
13	—	Pr.617	Pr.617	Pr.86	Pr.566
14	OFF	Pr.86	Pr.566	Pr.617	Pr.617
	ON	Pr.86	Pr.566	Pr.86	Pr.566
15	OFF	Pr.617	Pr.617	Pr.86	Pr.566
	ON	Pr.86	Pr.566	Pr.86	Pr.566

- When the SF-PR/SF-HR/SF-HRCA motor is used (**Pr.71** = "40, 43, 44, 50, 53, 54, 70, 73, or 74") and "9999" is set in **Pr.85/Pr.86**, the predetermined setting in the following table is applied.

Motor capacity (kW)	SF-PR						SF-HR/SF-HRCA					
	Pr.81 = "2"		Pr.81 = "4"		Pr.81 = "6"		Pr.81 = "2"		Pr.81 = "4"		Pr.81 = "6"	
	Pr.85	Pr.86	Pr.85	Pr.86	Pr.85	Pr.86	Pr.85	Pr.86	Pr.85	Pr.86	Pr.85	Pr.86
0.4	—	—	—	—	—	—	10 Hz	130%	10 Hz	130%	10 Hz	130%
0.75	20 Hz	130%	20 Hz	130%	10 Hz	130%	10 Hz	130%	10 Hz	130%	10 Hz	130%
1.5	30 Hz	140%	10 Hz	130%	10 Hz	130%	10 Hz	130%	10 Hz	130%	10 Hz	130%
2.2	10 Hz	150%	10 Hz	130%	20 Hz	130%	20 Hz	150%	10 Hz	130%	10 Hz	130%
3.7	30 Hz	150%	25 Hz	133%	20 Hz	130%	30 Hz	160%	30 Hz	140%	10 Hz	130%
5.5	10 Hz	150%	10 Hz	130%	30 Hz	130%	30 Hz	140%	30 Hz	140%	20 Hz	140%
7.5	10 Hz	150%	30 Hz	118%	30 Hz	130%	30 Hz	140%	30 Hz	140%	30 Hz	150%
11	10 Hz	150%	20 Hz	140%	10 Hz	130%	30 Hz	140%	10 Hz	130%	30 Hz	130%
15	10 Hz	150%	30 Hz	130%	30 Hz	130%	20 Hz	140%	10 Hz	130%	30 Hz	130%
18.5	10 Hz	150%	30 Hz	130%	20 Hz	130%	30 Hz	150%	30 Hz	140%	30 Hz	140%
22	30 Hz	130%	10 Hz	130%	10 Hz	130%	30 Hz	150%	30 Hz	140%	20 Hz	140%
30	10 Hz	150%	20 Hz	130%	10 Hz	130%	30 Hz	150%	20 Hz	150%	10 Hz	130%
37	20 Hz	140%	10 Hz	140%	20 Hz	130%	20 Hz	160%	20 Hz	150%	10 Hz	130%
45	10 Hz	140%	20 Hz	130%	10 Hz	130%	10 Hz	130%	20 Hz	140%	10 Hz	140%
55	20 Hz	140%	30 Hz	130%	—	—	10 Hz	140%	20 Hz	150%	—	—

## 5.16.5 Energy saving control



The inverter will automatically perform energy saving operation without setting detailed parameters.

This control method is suitable for applications such as fans and pumps.

Pr.	Name	Initial value	Setting range	Description
60 G030	Energy saving control selection	0	0	Normal operation
			4	Energy saving operation
			9	Optimum excitation control

### ◆ Energy saving operation (Pr.60 = "4")

- Setting **Pr.60** = "4" will select the energy saving operation.
- With the energy saving operation, the inverter will automatically control the output voltage so the inverter output power during the constant-speed operation will become minimal.
- Energy saving operation will be enabled under V/F control.

### ◆ Optimum excitation control (Pr.60 = "9")

- Setting **Pr.60** = "9" will select the Optimum excitation control.
- The Optimum excitation control is a control method to decide the output voltage by controlling the excitation current so the efficiency of the motor is maximized.
- Optimum excitation control will be enabled under V/F control and Advanced magnetic flux vector control.

**NOTE**

- In the energy saving operation mode, an energy saving effect is not expected for applications with high load torque or with the equipment with frequent acceleration and deceleration.
- In the Optimum excitation control mode, an energy saving effect is not expected when the motor capacity is extremely small compared with the inverter capacity or when multiple motors are connected to a single inverter.
- When the energy saving operation mode or Optimum excitation control mode is selected, the deceleration time may become longer than the setting value. Also, it may cause overvoltage more often compared to constant-torque load characteristics, so set the deceleration time longer.
- When the motor becomes unstable during the acceleration, set the acceleration time longer.
- Output current may increase slightly with the energy saving operation mode or the Optimum excitation control mode since the output voltage is controlled.

## 5.16.6 Adjustable 5 points V/F

**V/F**

By setting a desired V/F characteristic from the start up to the base frequency or base voltage with the V/F control (frequency voltage/frequency), a dedicated V/F pattern can be generated.

The optimal V/F pattern matching the torque characteristics of the facility can be set.

Pr.	Name	Initial value	Setting range	Description
71 C100	Applied motor	0	2	Standard motor (such as SF-JR) Adjustable 5 points V/F
			Others	Refer to <a href="#">page 528</a> .
100 G040	V/F1 (first frequency)	9999	0 to 590 Hz, 9999	Set each point of the V/F pattern (frequency, voltage). 9999: Do not set V/F.
101 G041	V/F1 (first frequency voltage)	0 V	0 to 1000 V	
102 G042	V/F2 (second frequency)	9999	0 to 590 Hz, 9999	
103 G043	V/F2 (second frequency voltage)	0 V	0 to 1000 V	
104 G044	V/F3 (third frequency)	9999	0 to 590 Hz, 9999	
105 G045	V/F3 (third frequency voltage)	0 V	0 to 1000 V	
106 G046	V/F4 (fourth frequency)	9999	0 to 590 Hz, 9999	
107 G047	V/F4 (fourth frequency voltage)	0 V	0 to 1000 V	
108 G048	V/F5 (fifth frequency)	9999	0 to 590 Hz, 9999	
109 G049	V/F5 (fifth frequency voltage)	0 V	0 to 1000 V	

- By setting the **V/F1 (first frequency voltage/first frequency) to V/F5** parameters in advance, a desired V/F characteristic can be obtained.
- For an example, with the equipment with large static friction factor and small dynamic friction factor, large torque is required only at the start up, so a V/F pattern that will raise the voltage only at the low-speed range is set.
- Setting procedure
  1. Set the rated motor voltage in **Pr.19 Base frequency voltage**.  
(No function at the setting of "9999" or "8888".)
  2. Set **Pr.71 Applied motor** = "2" (adjustable 5 points V/F).

**3.** Set frequency and voltage to be set in **Pr.100 to Pr.109**.

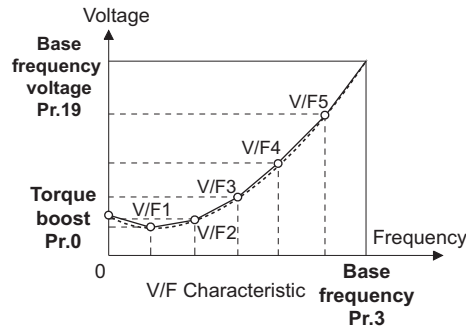

**CAUTION**

- Make sure to set the parameters correctly according to the motor used. Incorrect setting may cause the motor to overheat and burn.

**NOTE**

- The adjustable 5 points V/F is enabled under V/F control.
- When **Pr.19 Base frequency voltage** = "8888 or 9999", setting of **Pr.71** = "2" is not available. To set "2" in **Pr.71**, set the rated motor voltage in **Pr.19**.
- A write disable error "Er 1" is generated when the same frequency value is used for multiple points.
- Set frequency or voltage for each point in **Pr.100 to Pr.109** within the range of **Pr.3 Base frequency** or **Pr.19 Base frequency voltage**.
- When **Pr.71** = "2", **Pr.47 Second V/F (base frequency)** and **Pr.113 Third V/F (base frequency)** are not available.
- When **Pr.71** = "2", the inverter calculates the characteristic of the electronic thermal relay for a standard motor.
- By simultaneously using **Pr.60 Energy saving control selection** and the adjustable 5 points V/F, further energy saving effect is expected.
- The **Pr.0 Torque boost** and **Pr.12 DC injection brake operation voltage** settings are automatically changed according to the **Pr.71** setting. (Refer to [page 531](#).)

Parameters referred to

- Pr.0 Torque boost [page 706](#)
- Pr.3 Base frequency, Pr.19 Base frequency voltage [page 707](#)
- Pr.12 DC injection brake operation voltage [page 715](#)
- Pr.47 Second V/F (base frequency), Pr.113 Third V/F (base frequency) [page 713](#)
- Pr.60 Energy saving control selection [page 712](#)
- Pr.71 Applied motor, Pr.450 Second applied motor [page 528](#)

## 5.16.7 SF-PR slip amount adjustment mode

**V/F**

- As compared to our conventional SF-JR motor, the slip amount is small for the high-performance energy-saving SF-PR motor. When replacing the SF-JR to the SF-PR, the slip amount is reduced and the rotations per minute increases. Therefore, when the SF-PR is used with the same frequency setting as that of the SF-JR, power consumption may increase as compared to the SF-JR.
- By setting the slip amount adjustment mode, the frequency command can be adjusted to keep the rotations per minute of the SF-PR equivalent to those of the SF-JR for power consumption reduction.

Pr.	Name	Initial value	Setting range	Description
673 G060	SF-PR slip amount adjustment operation selection	9999	2, 4, 6	Set the number of SF-PR motor poles.
			9999	The slip amount adjustment is disabled.
674 G061	SF-PR slip amount adjustment gain	100%	0 to 500%	Setting is available for fine adjustment of the slip amount.

- By setting the number of SF-PR motor poles in **Pr.673 SF-PR slip amount adjustment operation selection**, the SF-PR slip amount adjustment mode is activated.
- The SF-PR slip amount adjustment mode is available only under V/F control.

- Use **Pr.674 SF-PR slip amount adjustment gain** to fine-tune the rotations per minute. To reduce the rotations per minute (to increase the compensation frequency), set a larger value in **Pr.674**. To increase the rotations per minute (to reduce the compensation frequency), set a smaller value in **Pr.674**. (Lower rotations per minute reduce the power consumption, and higher rotations per minute increase the power consumption.)

**NOTE**

- The slip amount adjustment is not available in the following conditions.  
During acceleration/deceleration, during DC injection brake operation, during PID control, during orientation control, during encoder feedback control, during stall prevention operation, during regeneration avoidance operation, during traverse operation, and while the slip compensation is valid (**Pr.245**).
- The slip amount adjustment is not available when the applicable motor capacity of the inverter is not compatible with the SF-PR. (For details on applicable motor capacity, refer to [page 826](#).)

## 5.16.8 DC injection brake, zero speed control, and servo lock

- Adjust the braking torque and timing to stop the motor using the DC injection brake.  
Zero speed control is also available under Real sensorless vector control, and zero speed control and servo lock are selectable under Vector control or PM sensorless vector control.  
When the DC injection brake operation is used, DC voltage is applied to the motor to prevent rotation of the motor shaft, and when the zero speed control is used, Vector control is performed to keep 0 r/min. Either way, when a motor shaft is rotated by external force, it does not go back to the original position.  
When the servo lock control is used, the position of the motor shaft is held. When a motor shaft is rotated by external force, it goes back to the original position.
- Select the magnetic flux decay output shutoff function to decay the magnetic flux before shutting off the output at a stop.

Pr.	Name	Initial value	Setting range	Description	
10 G100	DC injection brake operation frequency	3 Hz	0 to 120 Hz	Set the operation frequency for the DC injection brake (zero speed control / servo lock).	
			9999	The operation starts at the frequency set in <b>Pr.13</b> or lower.	
11 G101	DC injection brake operation time	0.5 s	0	Without DC injection brake (zero speed control / servo lock)	
			0.1 to 10 s	Set the operation time for the DC injection brake (zero speed control / servo lock).	
			8888	The operation continues while the X13 signal is ON.	
12 G110	DC injection brake operation voltage	4% <sup>*1</sup>	0 to 30%	Set the DC injection brake voltage (torque). When set to "0", the DC injection brake is not applied.	
		2% <sup>*2</sup>			
		1% <sup>*3</sup>			
802 G102	Pre-excitation selection	0	0	Zero speed control	
			1	Servo lock	
1299 G108	Second pre-excitation selection	0	0	Zero speed control	The pre-excitation operation of the second motor can be selected.
			1	Servo lock	
850 G103	Brake operation selection	0	0	DC injection brake operation	
			1	Zero speed control (Real sensorless vector control)	
			2	Magnetic flux decay output shutoff (Real sensorless vector control)	

\*1 The initial value for the FR-A820-00490(7.5K) or lower and FR-A840-00250(7.5K) or lower.

\*2 The initial value for the FR-A820-00630(11K) to FR-A820-03160(55K), FR-A840-00310(11K) to FR-A840-01800(55K).

\*3 The initial value for the FR-A820-03800(75K) or higher and FR-A840-02160(75K) and higher.

### ◆ Setting of operating frequency (Pr.10)

- By setting the frequency to operate the DC injection brake (zero speed control / servo lock) to **Pr.10 DC injection brake operation frequency**, the DC injection brake (zero speed control / servo lock) will operate when it reaches this frequency at the time of deceleration.
- When **Pr.10** = "9999", DC injection brake (zero speed control / servo lock) will start when the frequency reaches **Pr.13 Starting frequency**.



- The DC injection brake operation frequency depends on the stopping method.

Stopping method	Parameter setting	DC injection brake operation frequency
Press the STOP key on the operation panel. Turn OFF the STF/STR signal.	0.5 Hz or higher in <b>Pr.10</b>	<b>Pr.10</b> setting
	Lower than 0.5 Hz in <b>Pr.10</b> , and 0.5 Hz or higher in <b>Pr.13</b>	0.5 Hz
	Lower than 0.5 Hz in both <b>Pr.10</b> and <b>Pr.13</b>	<b>Pr.10</b> or <b>Pr.13</b> setting, whichever larger
Set frequency to 0 Hz	—	<b>Pr.13</b> setting or 0.5 Hz, whichever smaller

- The DC injection brake operation frequency will be fixed to 0 Hz under PM sensorless vector control (low-speed range high-torque mode disabled).

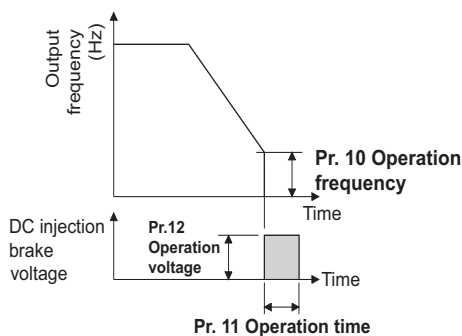

**NOTE**

- When executing pre-excitation (zero speed control) under Real sensorless vector control, set **Pr.10 DC injection brake operation frequency** to 0.5 Hz or lower since it may cause motor vibration, etc., at the time of deceleration stop.
- The initial value of **Pr.10** will automatically switch to 0.5 Hz under Vector control.

### ◆ Setting of operation time (X13 signal, Pr.11)

- Set the operation time for the DC injection brake (zero speed control / servo lock) to **Pr.11 DC injection brake operation time**.
- When the motor does not stop due to large load moment (J), increase the setting to ensure the effect.
- When **Pr.11** = "0 s", DC injection brake (zero speed control / servo lock) will not operate. (The motor will coast to stop.)
- When **Pr.11** = "8888", DC injection brake (zero speed control / servo lock) will operate when the X13 signal is turned ON. DC injection brake will operate when the X13 signal is turned ON even while operating.
- For the X13 signal input, set "13" in any of **Pr.178 to Pr.189** to assign the function.

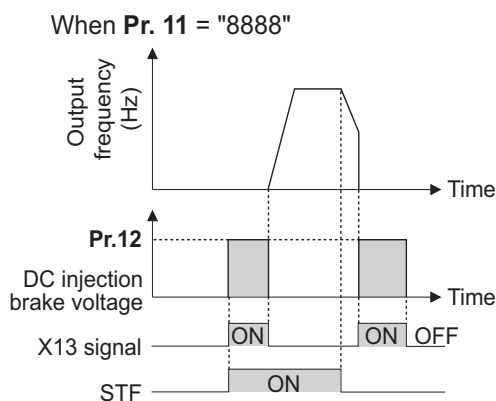

**NOTE**

- Under Real sensorless vector control, when the X13 signal turns ON while **Pr.11** = "8888", the zero speed control is activated regardless of the **Pr.850 Brake operation selection** setting.
- Under Vector control or PM sensorless vector control, zero speed control or servo lock will operate depending of the setting of **Pr.802**.
- The X13 signal is disabled during PM sensorless vector control.

## ◆ Setting of operation voltage (torque) (Pr.12)

- Set the percentage against the power supply voltage in **Pr.12 DC injection brake operation voltage**. (The setting is not used for zero speed control or servo lock.)
- The DC injection brake operation is not available when the setting of **Pr.12** is 0%. (The motor will coast to stop.)

### NOTE

- When the setting of **Pr.12** is the initial value, the setting corresponding to the motor is set according to the **Pr.71 Applied motor** setting. (Refer to [page 531](#).) However, when an energy saving motor (SF-HR or SF-HRCA) is used, change the **Pr.12** setting as shown below.

Inverter	Pr.12 setting
FR-A820-00250(3.7K) or lower FR-A840-00126(3.7K) or lower	4%
FR-A820-00340(5.5K), FR-A820-00490(7.5K) FR-A840-00170(5.5K), FR-A840-00250(7.5K)	3%
FR-A820-00630(11K) to FR-A820-01250(22K), FR-A820-01870(37K) or higher FR-A840-00310(11K) to FR-A840-00620(22K), FR-A840-00930(37K) or higher	2%
FR-A820-01540(30K) FR-A840-00770(30K)	1.5%

- Even if the setting value of **Pr.12** is made larger, braking torque will be limited so the output current will be within the rated current of the inverter.

## ◆ Braking operation selection under Real sensorless vector control (Pr.850 = "0 or 1")

- The braking operation under Real sensorless vector control can be selected between the DC injection brake operation (initial setting) and zero speed control.  
By setting **Pr.850 Brake operation selection = "1"**, zero speed control will be performed at the frequency set in **Pr.10 DC injection brake operation frequency** or lower.

### NOTE

- Under Real sensorless vector control, when the X13 signal turns ON while **Pr.11 = "8888"**, zero speed control is activated regardless of the **Pr.850** setting.
- When restarting the operation after a brake operation under Real sensorless vector control, set **Pr.850 = "1"** (zero speed control). Setting "0" (DC injection brake) may cause a delay of about 2 seconds from the time the start up command is input until it actually is output.

## ◆ Magnetic flux decay output shutoff and the Magnetic flux decay output shutoff signal (X74 signal, Pr.850 = "2")

- Frequent starts/stops (inching) under Real sensorless vector control may cause an inverter failure or create a difference in operation with the motor. The reason is that some magnetic flux is left in the motor at shutoff of the inverter output. If this is the case, set **Pr.850 = "2"** (magnetic flux decay output shutoff) or turn ON the Magnetic flux decay output shutoff (X74) signal to decay the magnetic flux at a stop, and then shut off the output.
- While **Pr.850 = "2"**, deceleration starts at turning OFF of the start command, and the magnetic flux decay output shutoff is activated when the estimated speed becomes lower than **Pr.10 DC injection brake operation frequency**.
- While the brake sequence function is active, the magnetic flux decay output shutoff is activated when the running frequency drops to 0.5 Hz or **Pr.13 Starting frequency**, whichever is smaller.

- Inverter output voltage shutoff timing when **Pr.850 = "2"**

**Normal operation**

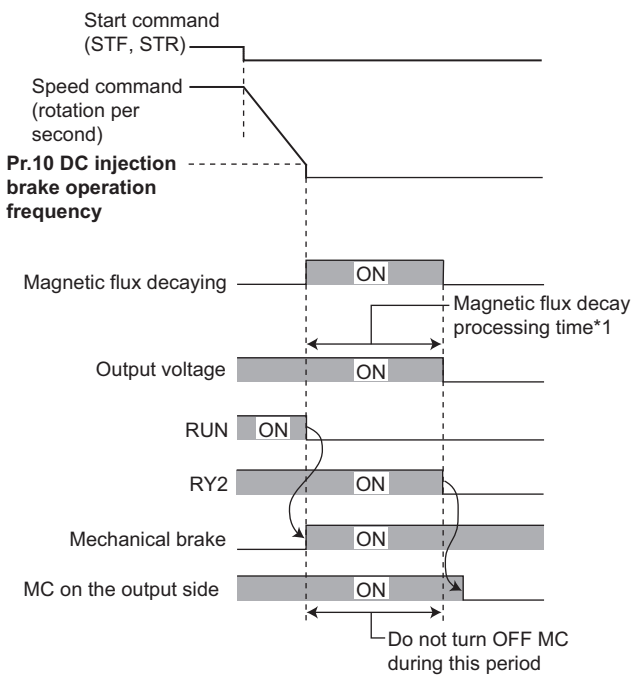

**During brake sequence**

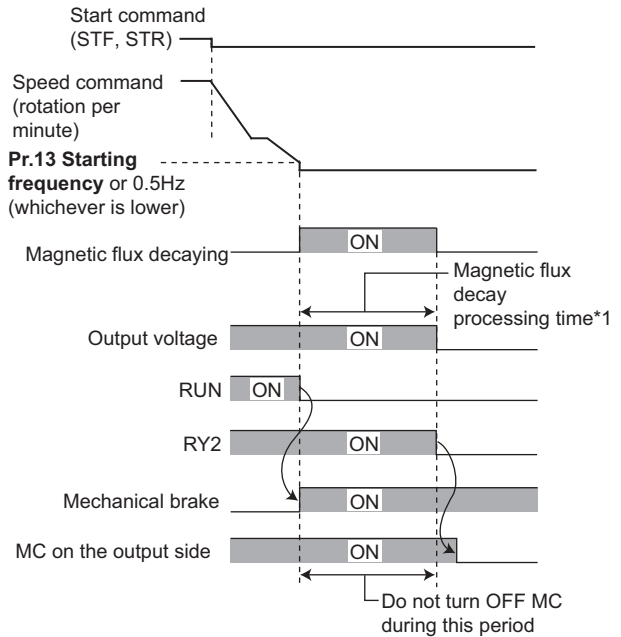

\*1 Maximum processing time of the magnetic flux decay

- Tuning ON the Magnetic flux decay output shutoff (X74) signal starts the magnetic flux decay output shutoff regardless of the **Pr.850** setting. For the X74 signal, set "74" in any of **Pr.178 to 189 (Input terminal function selection)** to assign the function.
- Inverter output shutoff timing with X74 signal

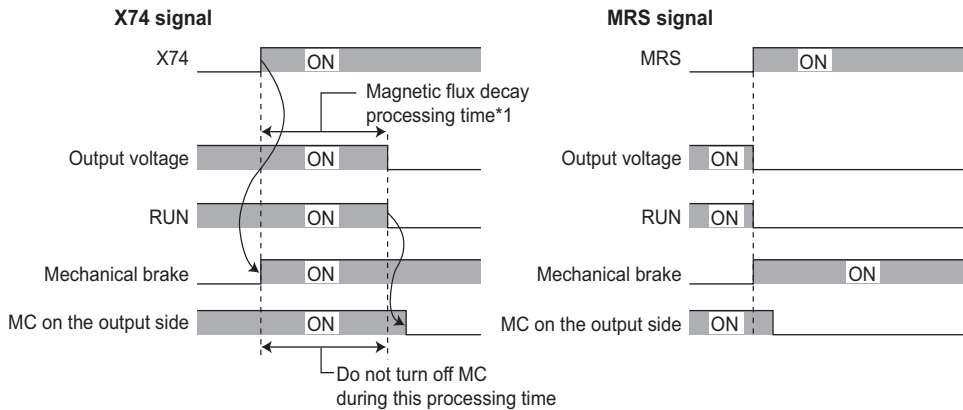

\*1 Maximum processing time of the magnetic flux decay

- Since the torque will decrease at the time of magnetic flux decay output shutoff, set up so the mechanical brake will operate.
- The magnetic flux decay output shutoff will be canceled at the time of restart and when the Pre-excitation/servo ON (LX) signal or External DC injection brake operation start (X13) signal is turned ON.
- If an MC is installed at the inverter's output side, set to open the MC after the operation time of the magnetic flux decay output shutoff elapses. (See below.)

Motor capacity (Pr.80 setting)	2.2 kW or lower	3.7 kW to 11 kW	15 kW to 30 kW	37 kW to 55 kW	75 kW or higher
Magnetic flux decay process time	250 ms	500 ms	800 ms	900 ms	1100 ms

**NOTE**

- When operating under controls other than Real sensorless vector control, the inverter will immediately shutoff the output when the X74 signal is turned ON.
- Even under Real sensorless vector control, the inverter will immediately shutoff the output when the X74 signal is turned ON during the automatic restart after instantaneous power failure and online auto tuning during the start up.
- If another output-shutoff trigger (inverter fault, turn-ON of the MRS signal, etc.) occurs during the magnetic flux decay operation, the magnetic flux decay operation is terminated, and the output is shut off immediately.
- Unlike the MRS signal, voltage is output during the magnetic flux decay output shutoff operation, so take caution on electric shocks.
- When the release timing of the mechanical brake is too fast, the motor shaft may be rotated by dropping or external force. When the release timing is too late, the overcurrent prevention operation, stall prevention operation, or electronic thermal O/L relay function may be activated. Perform release of the mechanical brake matching the equipment using the Output frequency detection (FU) signal or Output current detection (Y12) signal.
- Changing the terminal assignment using **Pr.178 to Pr.189 (Input terminal function selection)** may affect the other functions. Set parameters after confirming the function of each terminal.

**◆ Braking operation selection under Vector control or PM sensorless vector control (Pr.802, Pr.1299)**

- **Pr.802** Pre-excitation selection to select the braking operation when the pre-excitation is performed from either zero speed control or servo lock.
- Turning ON the RT signal enables the second pre-excitation selection (when **Pr.450** ≠ "9999").

Pr.802 (Pr.1299) setting	Pre-excitation	Description
0 (initial value)	Zero speed control	Even under a load, the inverter does not rotate the motor and holds 0 r/min. However, it will not return to its original position when the shaft moves due to external force. This setting is invalid during position control. The inverter operates according to this setting only during speed control.
1	Servo lock	Even under a load, the inverter holds the position of the motor shaft. When the shaft moves due to external force, it will return to its original position after the external force is removed. To perform the position control, this loop gain can be adjusted using <b>Pr.422 Position control gain (Pr.1298 Second position control gain)</b> .

- The relation between the DC injection brake operation and pre-excitation operation is as follows.

Control method	Control mode	Pr.802 (Pr.1299)	Pr.850	Deceleration stop	LX-ON	X13-ON (Pr.11 = "8888")
V/F control	—	—	—	DC injection brake	—	DC injection brake
Advanced magnetic flux vector control	—	—	—	DC injection brake	—	DC injection brake
Real sensorless vector control	Speed	—	0	DC injection braking	Zero speed	Zero speed
		—	1	Zero speed		
		—	2	Magnetic flux decay output shutoff		
	Torque	—	0	DC injection braking	Zero speed	Zero speed
		—	1	Zero speed		
		—	2	Magnetic flux decay output shutoff		
Vector control	Speed	0	—	Zero speed	Zero speed	Zero speed
		1	—	Servo lock	Servo lock	Servo lock
	Torque	—	—	Zero speed	Zero speed	Zero speed
	Position	—	—	—	Servo lock	—
PM sensorless vector control, low-speed range high-torque mode disabled	Speed	—	—	DC injection brake	—	—
PM sensorless vector control, low-speed range high-torque mode enabled	Speed	0	—	Zero speed	Zero speed	—
		1	—	Servo lock	Servo lock	—
	Position	—	—	—	Servo lock	—

## ◆ Pre-excitation signal (LX signal)

- When the Pre-excitation/servo ON (LX) signal is turned ON while the motor stops under Real sensorless vector control, Vector control, or PM sensorless vector control, pre-excitation (zero speed control / servo lock) starts.
- To input the LX signal, set "23" in any of **Pr.178 to Pr.189 (Input terminal function selection)** to assign the function.

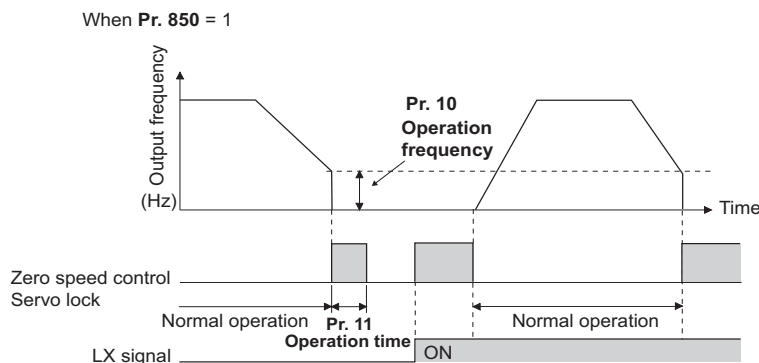

### NOTE

- Changing the terminal assignment using **Pr.178 to Pr.189 (Input terminal function selection)** may affect the other functions. Set parameters after confirming the function of each terminal.
- Performing pre-excitation (by using the LX or X13 signal) during torque control (under Real sensorless vector control) may rotate a motor at a low speed even though a start command (STF or STR) is not input. The inverter at a start command ON may also rotate the motor at a low speed even though a speed limit value is set to zero. It must be confirmed that the motor running will not cause any safety problem before performing pre-excitation.
- Note that during the pre-excitation operation, a voltage is applied to the motor even with the FWD/REV indicator OFF on the operation panel.
- When offline auto tuning (**Pr.96 Auto tuning setting/status** = "1, 11, or 101") is performed during pre-excitation operation, pre-excitation is disabled.

### CAUTION

- During the orientation operation, do not set "0 or 8888" in **Pr.11** and do not set "0" in **Pr.12**. The motor may not stop properly.
- Install a mechanical brake to make an emergency stop or to stay stopped for a long time. Wait until the machine stops completely, and fix the motor with a mechanical brake, then turn the LX signal (pre-excitation) OFF.

#### Parameters referred to

**Pr.13 Starting frequency** [page 381](#), [page 382](#)

**Pr.71 Applied motor** [page 528](#)

**Pr.80 Motor capacity** [page 532](#)

**Pr.178 to Pr.189 (Input terminal function selection)** [page 521](#)

**Pr.422 Position control gain, Pr.1298 Second position control gain** [page 328](#)

## 5.16.9 Output stop function

The motor coasts to a stop (inverter output is shutoff) when the inverter output frequency falls to **Pr.522** setting or lower.

Pr.	Name	Initial value	Setting range	Description
<b>522</b> <b>G105</b>	<b>Output stop frequency</b>	9999	0 to 590 Hz	Set the frequency to start coasting to a stop (output shutoff).
			9999	No function

- When both of the frequency setting signal and output frequency fall to the frequency set in **Pr.522** or lower, the inverter stops the output and the motor coasts to a stop.
- The motor re-starts when the frequency setting signal exceeds **Pr.522** + 2 Hz and is accelerated at the **Pr.13 Starting frequency** (0.01 Hz under PM sensorless vector control).

Example of when target frequency &gt; Pr.522+2Hz, and start signal is ON/OFF

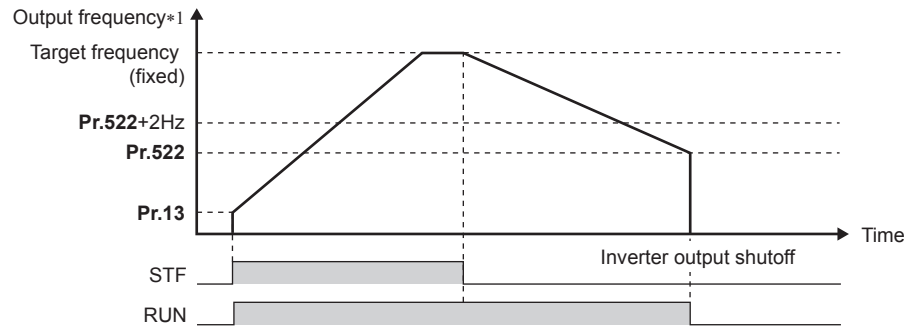

Example of: target frequency = analog input command, start signal always ON

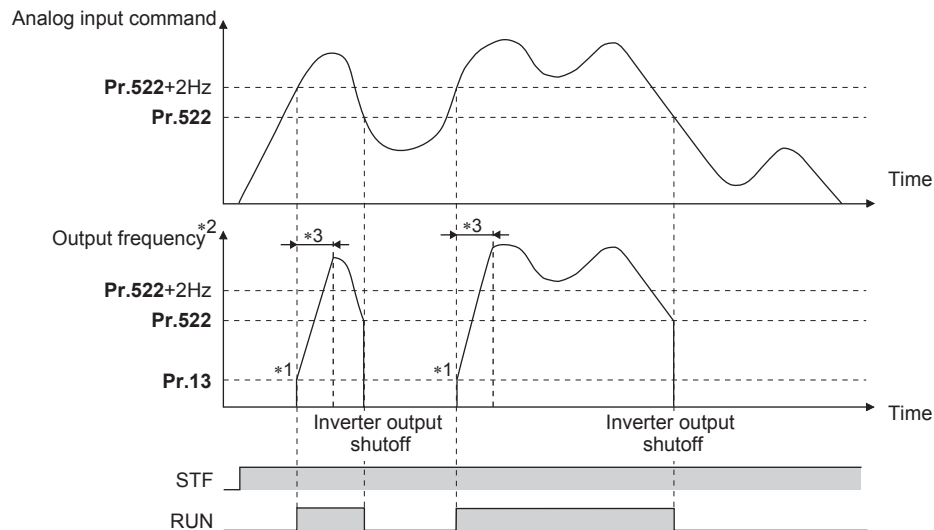

\*1 The output frequency to be compared with the **Pr.522** setting is the output frequency before slip compensation (V/F control or Advanced magnetic flux vector control), or the speed command value converted into the frequency (Real sensorless vector control, Vector control, or PM sensorless vector control).

\*2 The motor is accelerated at the **Pr.13 Starting frequency** (0.01 Hz under PM sensorless vector control).

\*3 The steepness of the slope depends on the acceleration/deceleration time settings such as **Pr.7**.

## NOTE

- When the output stop function is enabled (**Pr.522** ≠ "9999"), the DC injection brake (zero speed control / servo lock) operation is disabled and the motor coasts to stop when the output frequency drops to the **Pr.522** setting or lower.
- The motor starts acceleration again at **Pr.13 Starting frequency** (0.01 Hz under PM sensorless vector control) when the command value exceeds **Pr.522 + 2 Hz** again if the start signal remains ON while the motor is coasting after the frequency drops to the **Pr.522** setting or lower. Re-acceleration during coasting may cause an output shutoff of the inverter depending on the parameter setting. (Activation of the restart function is recommended especially for a PM motor.)
- The output stop frequency function is disabled during PID control, JOG operation, power failure stop, traverse function operation, offline auto tuning, orientation control, position control, torque control, or stop-on contact control.
- The output stop function does not operate during reverse rotation deceleration. However, when the frequency setting signal and output frequency fall to **Pr.522** or lower, the inverter output is shut off.
- During the output stop due to the output stop function (when forward/reverse command is given, but frequency command is not given), the FWD/REV LED indicator on the operation panel blinks fast. (When the frequency command is not given even if the forward/reverse command is given.)

## CAUTION

- A PM motor is a motor with interior permanent magnets. High voltage is generated at motor terminals while the motor is running.  
Do not touch motor terminals and other parts until the motor stops to prevent an electric shock.

## 5.16.10 Start signal operation selection / stop selection

Select the stopping method (deceleration stop or coasting) at turn-OFF of the start signal.

Coasting can be selected for the cases such that the motor is stopped with a mechanical brake at turn-OFF of the start signal.

The operation of the start signal (STF/STR) can be selected.

Pr.	Name	Initial value	Setting range	Description	
				Start signal (STF/STR)	Stop operation
250 G106	Stop selection	9999	0 to 100 s	STF signal: Forward rotation start STR signal: Reverse rotation start	The motor coasts to a stop after a lapse of the setting time when the start signal is turned OFF.
			1000 to 1100 s	STF signal: Start signal STR signal: Forward/reverse rotation signal	The motor coasts to a stop after a lapse of the (Pr.250 - 1000) seconds when the start signal is turned OFF.
			9999	STF signal: Forward rotation start STR signal: Reverse rotation start	The motor is decelerated to a stop when the start signal is turned OFF.
			8888	STF signal: Start signal STR signal: Forward/reverse rotation signal	

### ◆ Stop selection

#### ■ To decelerate the motor to a stop

- Set Pr.250 = "9999 (initial value) or 8888".
- The motor is decelerated to a stop when the start signal (STF/STR) is turned OFF.

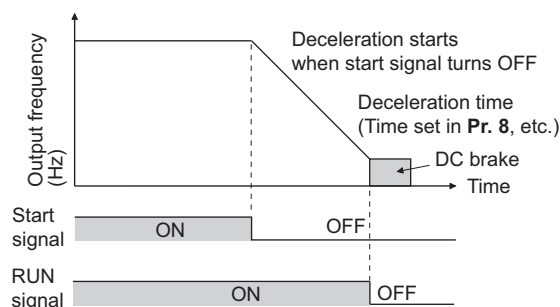

#### ■ To coast the motor to a stop

- Set the time required to shut off the output after the start signal is turned OFF in Pr.250. When "1000 to 1100" is set, output is shut off after a lapse of the (Pr.250 - 1000) seconds.
- The output is shut off after a lapse of the setting time of Pr.250 when the start signal is turned OFF. Motor coasts to a stop.
- The RUN signal is turned OFF when the output is shut off.

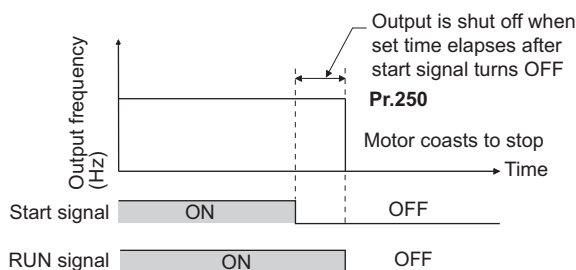

**NOTE**

- The stop selection setting is disabled when following functions are operating.
  - Position control
  - Power failure stop function (Pr.261)
  - PU stop (Pr.75)
  - Deceleration stop due to fault definition (Pr.875)
  - Deceleration stop due to communication error (Pr.502)
  - Offline auto tuning (with motor rotation)
- When Pr.250 ≠ "9999 or 8888", acceleration/deceleration is performed in accordance to the frequency command until the output is shut off by turning OFF the start signal.
- When the restart signal is turned ON during the motor coasting, the operation is resumed from Pr.13 Starting frequency.
- Even with the setting of coasting to a stop, when the LX signal is turned ON, the motor does not coast but zero speed control or servo lock is applied.

## ◆ Start signal operation selection

### ■ 2-wire type (STF signal, STR signal)

- The following figure shows the 2-wire type connection.
- As an initial setting, the forward/reverse rotation signals (STF/STR) acts as both start and stop signals. Either one turned ON will be enabled, and the operation will follow that signal. The motor will decelerate to a stop when both are turned OFF (or both are turned ON) during the operation.
- The frequency can be set by inputting 0 to 10 VDC between the speed setting input terminals 2 and 5, or with Pr.4 to Pr.6 Multi-speed setting (high speed, middle speed, and low speed). (For the multi-speed operation, refer to page 411.)
- By setting Pr.250 = "1000 to 1100, 8888", the STF signal input becomes the start command and the STR signal input becomes the forward/reverse command.

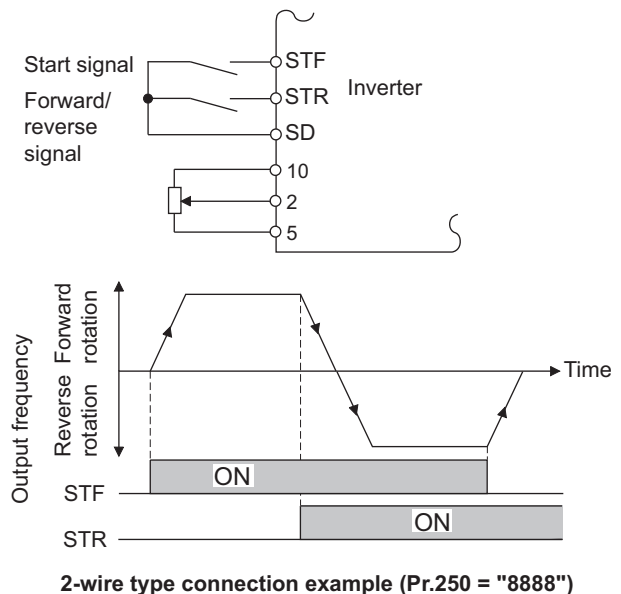
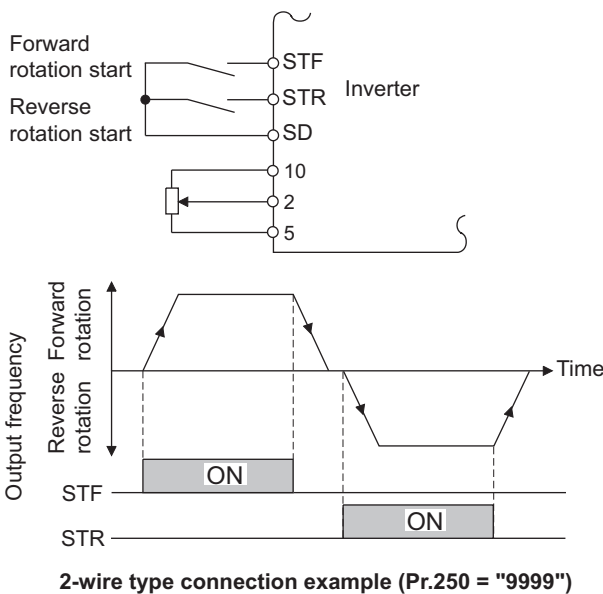

**NOTE**

- By setting Pr.250 = "0 to 100, 1000 to 1100", the motor will coast to a stop when the start command is turned OFF.
- The STF and STR signals are assigned to terminals STF and STR in the initial status. The STF signal can be assigned to terminal STF only using Pr.178 STF terminal function selection, and the STR signal can be assigned to terminal STR only using Pr.179 STR terminal function selection.

### ■ 3-wire type (STF signal, STR signal, STP (STOP) signal)

- The following figure shows the 3-wire type connection.
- The self-holding function is enabled when the STP (STOP) signal is turned ON. In such case, the forward/reverse signal is simply used as a start signal.



- Even if a start signal (STF or STR) is turned ON and then OFF, the start command remains valid and the motor operation continues. To change the rotation direction, turn the STR (STF) signal ON once and then OFF.
- In order to decelerate the motor to a stop, turn OFF the STP (STOP) signal once.

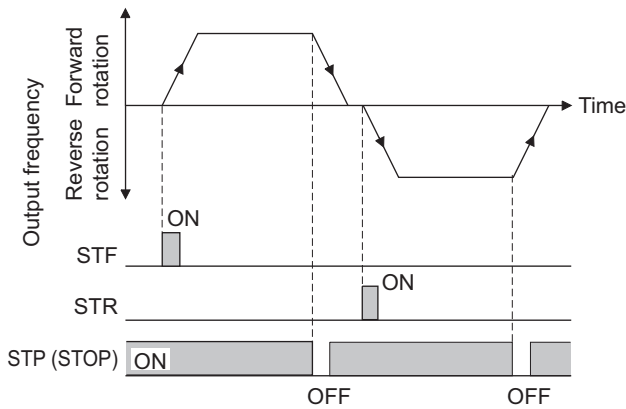
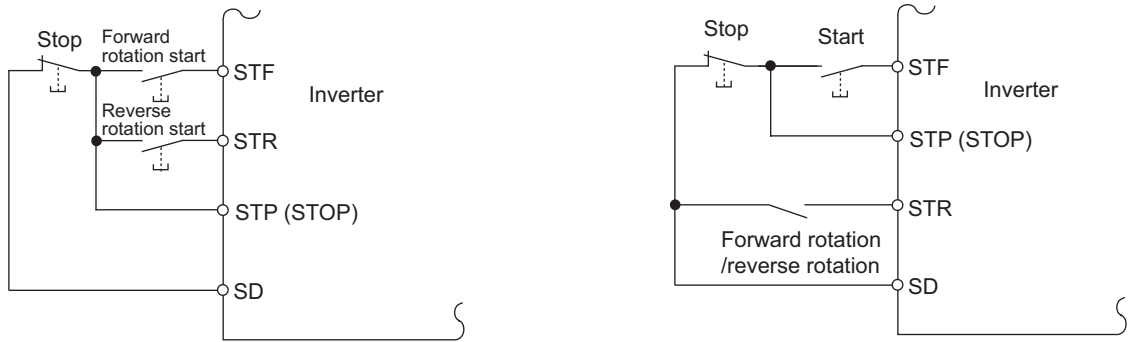

3-wire type connection example (Pr.250 = "9999")

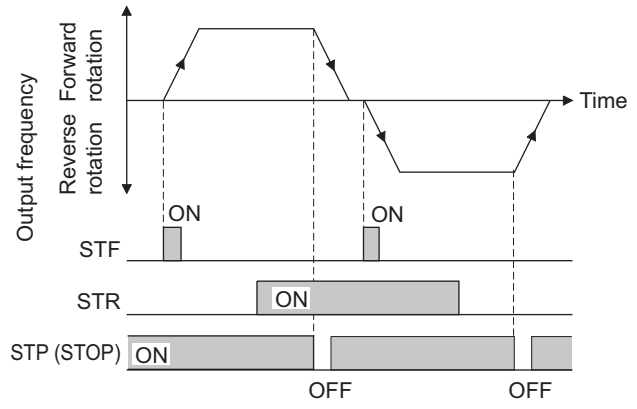

3-wire type connection example (Pr.250 = "8888")

**NOTE**

- The STP (STOP) signal is assigned to terminal STP (STOP) in the initial status. Set "25" in any of **Pr.178 to Pr.189** to assign the STP (STOP) signal to another terminal.
- When the JOG operation is enabled by turning ON the JOG signal, the STP (STOP) signal will be disabled.
- Even when the output is stopped by turning ON the MRS signal, the self-holding function is not canceled.

**Start signal selection**

STF	STR	Pr.250 setting and inverter status	
		0 to 100 s, 9999	1000 to 1100 s, 8888
OFF	OFF	Stop	Stop
OFF	ON	Reverse rotation	Stop
ON	OFF	Forward rotation	Forward rotation
ON	ON	Stop	Reverse rotation

Parameters referred to

- Pr.7 Acceleration time, Pr.8 Deceleration time [page 367](#)
- Pr.4 to Pr.6 (Multi-speed setting) [page 411](#)
- Pr.13 Starting frequency [page 381](#), [page 382](#)
- Pr.75 Reset selection/disconnected PU detection/PU stop selection [page 336](#)
- Pr.178 to Pr.189 (Input terminal function selection) [page 521](#)
- Pr.261 Power failure stop selection [page 642](#)
- Pr.419 Position command source selection [page 298](#)
- Pr.502 Stop mode selection at communication error [page 663](#)
- Pr.875 Fault definition [page 422](#)

## 5.16.11 Regenerative brake selection and DC feeding mode

- When performing frequent start and stop operation, usage rate of the regenerative brake can be increased by using the optional high-duty brake resistor (FR-ABR) or the brake unit (FR-BU2, BU, or FR-BU).

- The multifunction regeneration converter (FR-XC in power regeneration mode 1 or 2), power regeneration common converter (FR-CV), and power regeneration converter (MT-RC) are used for continuous operation during regenerative driving. The high power factor converter (FR-HC2) and multifunction regeneration converter (FR-XC in common bus regeneration mode) can also be used to reduce harmonics, improve power factor, and operate continuously during regenerative driving.
- It is possible to choose between the DC feeding mode 1, which will operate with DC power supply (terminals P and N), and DC feeding mode 2, which will normally operate in AC power supply (terminals R, S, and T) and operate in DC power supply (terminal P and N), such as batteries, at the time of power failure.
- While the power is supplied only to the control circuit, the reset operation when the power is supplied to the main circuit can be selected.

Pr.	Name	Initial value	Setting range	Description
30 E300	Regenerative function selection	0 <sup>*1*</sup> , 10 <sup>*2</sup>	0 to 2, 10, 11, 20, 21, 100 to 102, 110, 111, 120, 121 <sup>*1</sup> 2, 10, 11, 102, 110, 111 <sup>*2</sup> 0, 2, 10, 20, 100, 102, 110, 120 <sup>*3</sup>	Set the applied regeneration unit, the terminal used for power supply, and whether to reset the inverter when the power is supplied to the main circuit.
70 G107 <sup>*4</sup>	Special regenerative brake duty	0%	0 to 100%	Set the %ED of the built-in brake transistor operation.
599 T721	X10 terminal input selection	0 <sup>*1*</sup> , 1 <sup>*2</sup>	0 1	Normally open input Normally closed input (NC contact input specification)

\*1 The initial value or setting range for the standard model.

\*2 The initial value or setting range for the separated converter type.

\*3 The initial value or setting range for the IP55 compatible model.

\*4 The setting is available for the standard model.

## ◆ Details of the setting value

- FR-A820-03160(55K) or lower, FR-A840-01800(55K) or lower

Regeneration unit	Power supply terminals of inverter	Pr.30 setting <sup>*4</sup>	Pr.70 setting	Remarks
Built-in brake <sup>*3</sup> , brake unit (FR-BU2 (GZG/GRZG/FR-BR), FR-BU, BU)	R, S, T	0 (initial value), 100	—	The regenerative brake duty will be as follows. • FR-A820-00046(0.4K) to 00250(3.7K): 3% • FR-A820-00340(5.5K), 00490(7.5K): 2% • FR-A840-00023(0.4K) to 00250(7.5K): 2% • Other than above: 0% (without the built-in brake resistor)
	P, N	10, 110		
	R, S, T/P, N	20, 120		
High-duty brake resistor (FR-ABR)	R, S, T	1, 101	10% <sup>*1</sup> 6% <sup>*2</sup>	The FR-ABR can be used with FR-A820-01250(22K) or lower and the FR-A840-00620(22K) or lower.
	P, N	11, 111		
	R, S, T/P, N	21, 121		
Multifunction regeneration converter (FR-XC) (power regeneration mode 1 or 2)	R, S, T	0 (initial value)	—	—
High power factor converter (FR-HC2), multifunction regeneration converter (FR-XC) (common bus regeneration mode), power regeneration common converter (FR-CV)	P, N	2, 102	0% (initial value)	—

- FR-A820-03800(75K) or higher, FR-A840-02160(75K) or higher

Regeneration unit	Power supply terminals of inverter	Pr.30 setting <sup>*4</sup>	Pr.70 Setting
Without regenerative function	R, S, T	0 (initial value), 100	—
	P, N	10, 110	
	R, S, T/P, N	20, 120	
Brake unit (FR-BU2 (MT-BR5))	R, S, T	1, 101	0% (initial value)
	P, N	11, 111	
	R, S, T/P, N	21, 121	
Power regeneration converter (MT-RC)	R, S, T	1, 101	0% (initial value)
High power factor converter (FR-HC2)	P, N	2, 102	—
Multifunction regeneration converter (FR-XC) (power regeneration mode 1 or 2)	R, S, T	0 (initial value)	—

- FR-A842-07700(315K) or higher

Regeneration unit	Pr.30 setting <sup>*4</sup>
Without regenerative function (FR-CC2)	10 (initial value), 110
Brake unit (FR-CC2+FR-BU2 (MT-BR5))	11, 111
High power factor converter (FR-HC2)	2, 102

\*1 For the FR-A820-00490(7.5K) or lower and FR-A840-00250(7.5K) or lower.

\*2 For the FR-A820-00630(11K) or higher, and FR-A840-00310(11K) or higher.

\*3 The built-in brake is installed on FR-A820-00490(7.5K) or lower and FR-A840-00250(7.5K) or lower.

\*4 While the power is supplied only to the control circuit with **Pr.30** = "100 or higher", the inverter reset is not performed when the power is supplied to the main circuit.

## NOTE

- For the use of a brake resistor other than the FR-ABR, contact your sales representative.

### ◆ When using the built-in brake resistor or brake unit (FR-BU2, BU, FR-BU) (FR-A820-03160(55K) or lower, FR-A840-01800(55K) or lower)

- When using the built-in brake, using the FR-BU2 in combination with the GZG/GRZG/FR-BR, or using the BU or FR-BU, set **Pr.30** = "0 (initial value), 10, 20, 100, 110, or 120". The **Pr.70** setting is invalid. At this time, the regenerative brake duty is as follows.

Inverter	Regenerative brake duty
FR-A820-00250(3.7K) or lower	3%
FR-A820-00340(5.5K), FR-A820-00490(7.5K)	2%
FR-A840-00250(7.5K) or lower	2%
Other than the above	0% (without the built-in brake resistor)

## NOTE

- The built-in brake resistor is equipped for the FR-A820-00490(7.5K) or lower, and the FR-A840-00250(7.5K) or lower.

### ◆ When using the high-duty brake resistor (FR-ABR) (FR-A820-01250(22K) or lower, FR-A840-00620(22K) or lower)

- Set "1, 11, or 21" in **Pr.30**.
- Set **Pr.70** as follows.

Inverter	Pr.70 setting
FR-A820-00490(7.5K) or lower, FR-A840-00250(7.5K) or lower	10%
FR-A820-00630(11K) or higher, FR-A840-00310(11K) or higher	6%

### ◆ When using the brake unit (FR-BU2) (FR-A820-03800(75K) or higher, FR-A840-02160(75K) or higher)

- To use the FR-BU2 in combination with the MT-BR5, set as follows.
- Set "1, 11, or 21" in **Pr.30**.

- Set **Pr.70** = 0% (initial value).
- Set the brake unit FR-BU2, **Pr.0 Brake mode selection** = "2".

#### NOTE

- The stall prevention (overvoltage), oL, does not occur while **Pr.30** = "1, 11, or 21".

### ◆ When using the power regeneration converter (MT-RC)

- Set "1 or 101" in **Pr.30**.
- Set **Pr.70** = 0% (initial value).

### ◆ When using the high power factor converter (FR-HC2), multifunction regeneration converter (FR-XC), power regeneration common converter (FR-CV), or converter unit (FR-CC2)

- To use the FR-HC2 or FR-CV, set **Pr.30** = "2 or 102". The **Pr.70** setting is invalid.
- To use the FR-XC in common bus regeneration mode, set **Pr.30** = "2 or 102".
- To use the FR-XC in power regeneration mode, set **Pr.30** = "0 or 100".
- When using the FR-CC2, set **Pr.30** = "10" (initial value of the separated converter type).
- Use any of **Pr.178 to Pr.189 (Input terminal function assignment)** to assign the following signals to the contact input terminals.
  - (a) Inverter run enable (X10) signal: FR-HC2 connection, FR-XC connection, FR-CV connection, FR-CC2 connection  
To ensure coordinated protection of the FR-HC2, FR-XC (common bus regeneration mode), FR-CV, or FR-CC2, use the X10 signal to shut off the inverter output.  
Input the RDY signal of the FR-HC2 (the RYB signal of the FR-XC, the RDYB signal of FR-CV, or the RDA signal of FR-CC2).
  - (b) FR-HC2/FR-CC2 connection, instantaneous power failure detection (X11) signal: FR-HC2 connection, FR-CC2 connection  
During the operation using RS-485 communication, with the remote output and analog remote output functions enabled, the X11 signal is used to store the status when the inverter is set to store the status before an instantaneous power failure.  
Input the FR-HC2/FR-CC2 connection, instantaneous power failure detection signal.
- For the terminal used for the X10 or X11 signal, set "10" (X10) or "11" (X11) in any of **Pr.178 to Pr.189** and assign the function. (For the separated converter type, the X10 signal is assigned to terminal MRS in the initial setting.)

#### NOTE

- For details of the high-duty brake resistor (FR-ABR), brake unit, high power factor converter (FR-HC2), multifunction regeneration converter (FR-XC), or power regeneration common converter (FR-CV) connections, refer to [page 97](#). Also, for details on each option, refer to the Instruction Manual of each option.
- Setting **Pr.30** = "2" will reset the inverter, and "Err" is displayed on the operation panel during the reset.

### ◆ Logic reversing of the Inverter run enable signal (X10 signal, Pr.599)

- Use **Pr.599 X10 terminal input selection** to select the X10 signal input specification between normally open (NO contact) and normally closed (NC contact). With the normally closed (NC contact) input specification, the inverter output is shut off by turning OFF (opening) the X10 signal.
- Changing the inverter logic (NO/NC contact) with the **Pr.599** setting is required according to the logic of the Inverter run enable signal sent from the option unit.

- The response time of the X10 signal is within 2 ms.

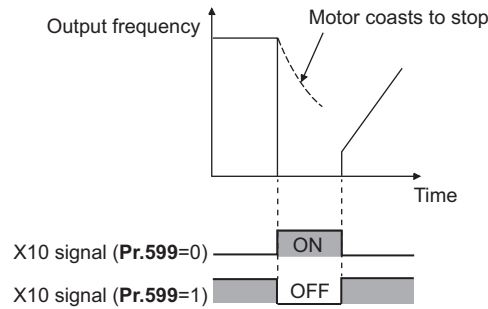

- Relationship between **Pr.599** and the Inverter run enable signal of each option unit

Pr.599 setting	Corresponding signals of the option unit				Operation according to the X10 signal status
	FR-HC2	FR-XC	FR-CV	FR-CC2	
0 (initial value of standard structure models and IP55 compatible models)	RDY (negative logic) (initial setting)	RYB	RDYB	RDB	X10-ON: Inverter output shutoff (NO contact)
1 (initial value of separated converter types)	RDY (positive logic)	RYA	RDYA	RDA	X10-OFF: Inverter output shutoff (NC contact)

### NOTE

- If the X10 signal is unassigned while **Pr.30** = "2" (FR-HC2/FR-XC/FR-CV connection) or "10 or 11" (DC feeding mode 1), the MRS signal can be used as the X10 signal. At this time, logic setting for the signal will follow **Pr.17 MRS input selection**.
- The MRS signal is valid from either of communication or external, but when the MRS signal is to be used as the Inverter run enable (X10) signal, it must be input from external.
- When the FR-HC or MT-HC is connected, set **Pr.599** = "0 (initial value)".
- When the terminal assignment is changed with **Pr.178 to Pr.189 (Input terminal function selection)**, wiring may be mistaken due to different terminal name and signal contents, or may affect other functions. Set parameters after confirming the function of each terminal.

## ◆ Regenerative brake duty warning output and the warning signal (RBP signal) (standard models)

- When the regenerative brake duty reaches 85% of the **Pr.70** setting, "RB" is indicated on the operation panel and the Regenerative brake prealarm signal (RBP) signal is output. When it reaches 100% of the **Pr.70** setting, it will become regenerative overvoltage (E.OV[]).
- The inverter output is not shut off with the warning signal.
- For the terminal to be used for the RBP signal output, set "7 (positive logic) or 107 (negative logic)" to one of **Pr.190 to Pr.196 (Output terminal function selection)**, and assign the function.

100%: Regeneration overvoltage protection operation value

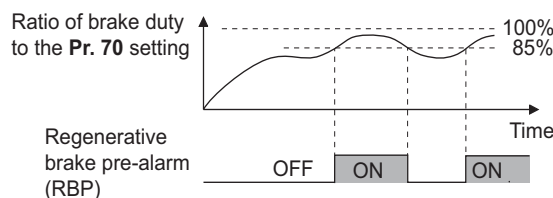

### NOTE

- When **Pr.30** = "0 (initial value), 10, or 20" for the FR-A820-00630(11K) or higher and the FR-A840-00310(11K) or higher, "RB" is not indicated.
- Changing the terminal assignment using **Pr.190 to Pr.196 (Output terminal function selection)** may affect the other functions. Set parameters after confirming the function of each terminal.

## ◆ Selection between resetting or not resetting during power supply to main circuit (Pr.30 = "100, 101, 102, 110, 111, 120, or 121")

- Inverter reset is not performed if Pr.30 = "100" or more, and supplying power to the main circuit (input through terminals R/L1, S/L2, and T/L3) is started when power is supplied only to the control circuit (input through terminals R1/L11 and S1/L12, or 24 V external power supply input).
- When a communication option, etc. is used, communication interruption due to the inverter reset can be avoided.

### NOTE

- When supplying power to the main circuit is started while the protective function of the inverter is activated, inverter reset is performed even when "not resetting after power-ON" is selected.

## ◆ DC feeding mode 1 (Pr.30 = "10 or 11") (standard models and IP55 compatible models)

- For standard models and IP55 compatible models, setting Pr.30 = "10 or 11" allows operation with a DC power supply.
- Keep the AC power supply connection terminals R/L1, S/L2, and T/L3 open, and connect the DC power supply between terminals P/+ and N/-. Also, for the standard model, remove the jumpers between terminals R/L1 and R1/L11 and between terminals S/L2 and S1/L21, and connect the terminals R1/L11 and S1/L21 to the terminals P/+ and N/- respectively.
- The following diagram shows a connection example.

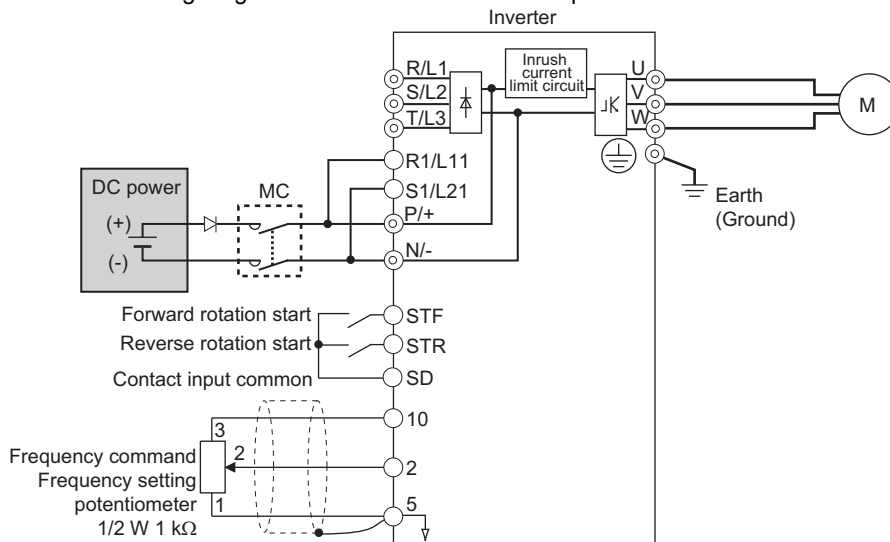

### CAUTION

- Do not connect a separated converter type inverter to a DC power supply. Doing so may damage the inverter.

## ◆ DC feeding mode 2 (Pr.30 = "20 or 21") (standard models and IP55 compatible models)

- When Pr.30 = "20 or 21", it will normally operate with AC power supply and operate with DC power supply such as batteries at the time of power failure.
- Connect the AC power supply to the AC power supply connecting terminals R/L1, S/L2, and T/L3, and connect the DC power supply to the terminals P/+ and N/-. Also, for the standard model, remove the jumpers between terminals R/L1 and R1/L11 and between terminals S/L2 and S1/L21, and connect the terminals R1/L11 and S1/L21 to the terminals P/+ and N/- respectively.
- Operation with DC current is possible by turning ON the DC feeding operation permission (X70) signal. For details on the I/O signals, refer to following table.



• Operation example at the time of power failure occurrence 1

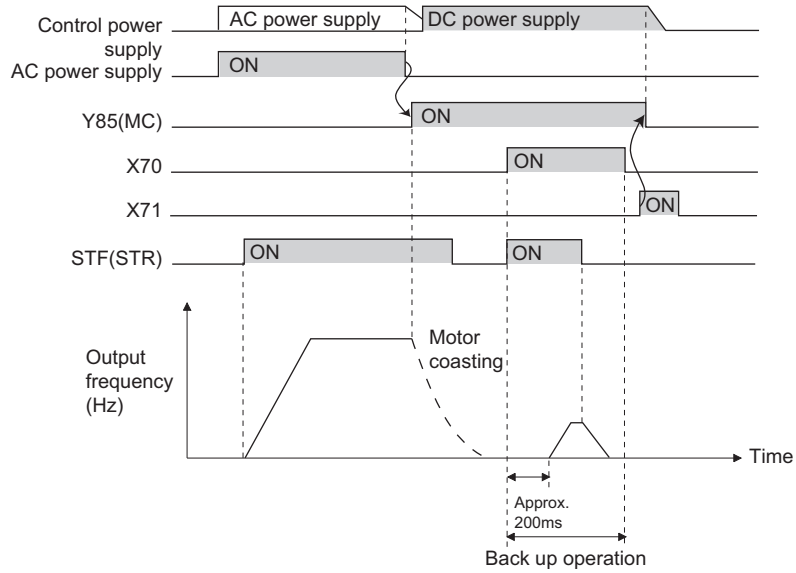

• Operation example at the time of power failure occurrence 2 (when the AC power supply is restored)

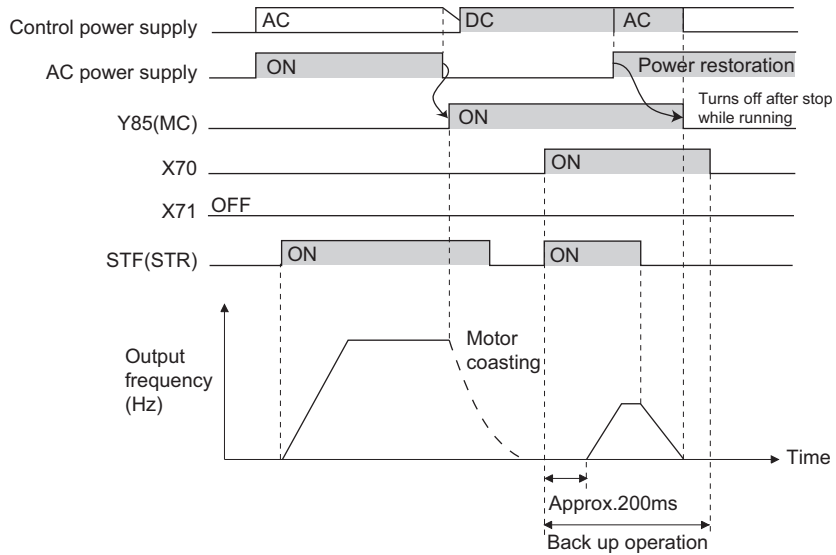

• Operation example at the time of power failure occurrence 3 (when continuing the operation)

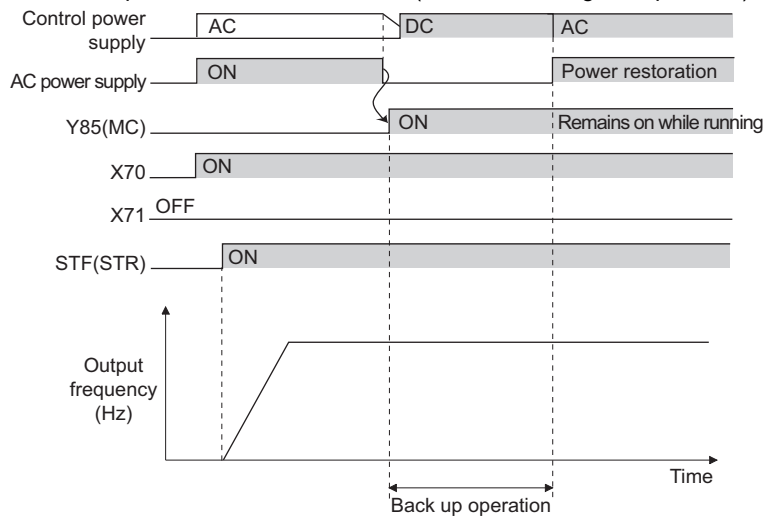



## ◆ Power supply specification for DC feeding (standard models and IP55 compatible models)

200 V class	Rated input DC voltage	283 to 339 VDC
	Permissible fluctuation	240 to 373 VDC
400 V class	Rated input DC voltage	537 VDC to 707 VDC
	Permissible fluctuation	457 VDC to 777 VDC

### NOTE

- The voltage between terminals P and N briefly increases to 415 V (830 V) or higher during the regenerative driving, so take caution on the selection of the DC power supply.
- When an AC power supply is connected to terminals R/L1, S/L2, and T/L3 during DC feeding with **Pr.30** = "2, 10, or 11" (DC feeding), an option fault (E.OPT) will occur.
- When the input voltage is insufficient during inverter operation with **Pr.30** = "2, 10, 11, 20, or 21" (DC feeding), the inverter output will be shut off. (The undervoltage protection function (E.UVT) is not activated.)
- When the inverter is operated with **Pr.30** = "2, 10, 11, 20, or 21" (DC feeding), detection of Instantaneous power failure (E.IPF) is not performed.
- When the DC power is switched ON, an inrush current higher than that for the AC power flows in the inverter. Minimize the number of power-ON events.
- Changing the terminal assignment using **Pr.178 to Pr.189 (Input terminal function selection)** or **Pr.190 to Pr.196 (Output terminal function selection)** may affect the other functions. Set parameters after confirming the function of each terminal.

### ⚠ WARNING

- The value set in **Pr.70** must not exceed the setting of the brake resistor used.  
It may cause overheating.

#### Parameters referred to

**Pr.17** MRS input selection [page 524](#)

**Pr.57** Restart coasting time [page 628](#), [page 635](#)

**Pr.178 to Pr.189** (Input terminal function selection) [page 521](#)

**Pr.190 to Pr.196** (Output terminal function selection) [page 473](#)

**Pr.261** Power failure stop selection [page 642](#)

## 5.16.12 Regeneration avoidance function

The regenerative status can be detected and avoided by raising the frequency.

- The operation frequency is automatically increased to prevent the regenerative operations. This function is useful when a load is forcibly rotated by another fan in the duct.

Pr.	Name	Initial value		Setting range	Description
882 G120	Regeneration avoidance operation selection	0		0	The regeneration avoidance function is disabled.
				1	The regeneration avoidance function is always enabled.
				2	The regeneration avoidance function is enabled only during constant-speed operation.
883 G121	Regeneration avoidance operation level	200 V class	380 VDC	300 to 1200 V	Set the bus voltage level to operate the regeneration avoidance operation. When the bus voltage level is set low, it will be harder to generate overvoltage error, but actual deceleration time will be longer. Set the setting value higher than the (power supply voltage $\times \sqrt{2}$ ) value.
		400 V class	760 VDC		
884 G122	Regeneration avoidance at deceleration detection sensitivity	0		0	The regeneration avoidance is disabled due to bus voltage change rate.
				1 to 5	Set the sensitivity to detect the bus voltage change rate. Setting value 1 (detection sensitivity: low) to 5 (detection sensitivity: high)
885 G123	Regeneration avoidance compensation frequency limit value	6 Hz		0 to 590 Hz	Set the limit value for frequency to rise when the regeneration avoidance function is activated.
				9999	The frequency limit is disabled.
886 G124	Regeneration avoidance voltage gain	100%		0 to 200%	Adjust the response during the regeneration avoidance operation. Increasing the setting improves the response to change in the bus voltage. However, the output frequency may become unstable. If setting a smaller value in <b>Pr.886</b> does not suppress the vibration, set a smaller value in <b>Pr.665</b> .
665 G125	Regeneration avoidance frequency gain	100%		0 to 200%	

### ◆ Regeneration avoidance operation (Pr.882, Pr.883)

- When the regenerative voltage increases, the DC bus voltage will rise, which may cause an overvoltage fault (E.OV[]). The regenerative status can be avoided by detecting this rise of bus voltage, and raising the frequency when the bus voltage level exceeds **Pr.883 Regeneration avoidance operation level**.
- The regeneration avoidance operation can be selected to operate constantly or operate only during constant speed.
- The regeneration avoidance function is enabled by setting "1 or 2" in **Pr.882 Regeneration avoidance operation selection**.

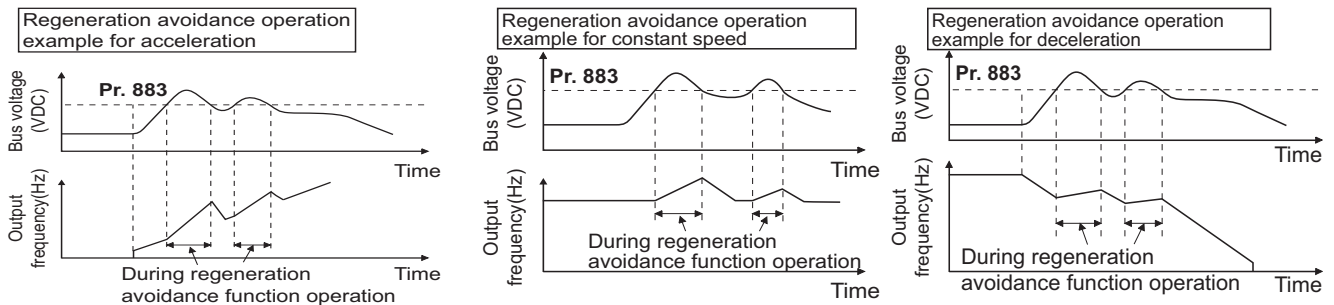

#### NOTE

- The slope of frequency rising or lowering by the regeneration avoidance operation will change depending on the regenerative status.
- The DC bus voltage of the inverter will be approximately  $\sqrt{2}$  times of the normal input voltage.  
The bus voltage is about 311 VDC (622 VDC) when the input voltage is 220 VAC (440 VAC). However, it may vary depending on the input power supply waveform.
- Make sure that the setting value of **Pr.883** will not get under DC bus voltage level. The frequency will rise with operation of the regeneration avoidance function even during operation other than the regenerative operation.
- The stall prevention (overvoltage) (oL) will only operate during deceleration, stopping the lowering of output frequency, but on the other hand, the regeneration avoidance function will constantly operate (**Pr.882** = "1") or operate only at constant speed (**Pr.882** = "2"), and raise the frequency depending on the amount of regeneration.
- When the motor becomes unstable due to operation of the stall prevention (overcurrent) (OL) during the regeneration avoidance operation, increase the deceleration time or lower the setting of **Pr.883**.
- During position control, the regeneration avoidance function is not activated.

## ◆ Detecting the regenerative status faster during deceleration (Pr.884)

- Since a rapid change in bus voltage cannot be handled by bus voltage level detection during the regeneration avoidance operation, deceleration is stopped by detecting the change in bus voltage and if it is equal to or lower than **Pr.883 Regeneration avoidance operation level**. Set the detectable bus voltage change rate as the detection sensitivity in **Pr.884 Regeneration avoidance at deceleration detection sensitivity**. A larger set value increases the detection sensitivity.

### NOTE

- When the setting value is too small (detection sensitivity is not good), detection will not be possible, and regeneration avoidance will operate even with the bus voltage change caused by a change in the input power.

## ◆ Limiting the regeneration avoidance operation frequency (Pr.885)

- It is possible to assign a limit to the output frequency corrected (rise) by the regeneration avoidance operation.
- Limit of the frequency is output frequency (frequency before regeneration avoidance operation) + **Pr.885 Regeneration avoidance compensation frequency limit value** for during acceleration and constant speed. During deceleration, when the frequency increases due to the regeneration avoidance operation and exceeds the limit value, the limit value will be retained until the output frequency is reduced to be the half the **Pr.885** setting.
- When the frequency that have increased by the regeneration avoidance operation exceeds **Pr.1 Maximum frequency**, it will be limited to the maximum frequency.
- When **Pr.885** = "9999", the regeneration avoidance compensation frequency limit is disabled.
- Set the frequency around the motor rated slip frequency. Increase the setting value if the overvoltage protection function (E.OV[]) is activated at the start of deceleration.

$$\text{Rated motor slip frequency} = \frac{\text{Synchronized speed at the time of base frequency} - \text{rated rotation speed}}{\text{Synchronized speed at the time of base frequency}} \times \text{Rated motor frequency}$$

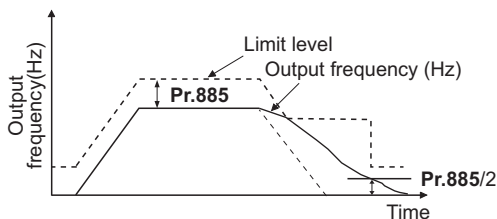

## ◆ Adjusting the regeneration avoidance operation (Pr.665, Pr.886)

- If the frequency becomes unstable during regeneration avoidance operation, decrease the setting of **Pr.886 Regeneration avoidance voltage gain**. On the other hand, if an overvoltage fault occurs due to a sudden regeneration, increase the setting.
- If setting a smaller value in **Pr.886** does not suppress the vibration, set a smaller value in **Pr.665 Regeneration avoidance frequency gain**.

### NOTE

- During the regeneration avoidance operation, the stall prevention (overvoltage) "oL" is displayed and the Overload warning (OL) signal is output. Set the operation pattern at an OL signal output using **Pr.156 Stall prevention operation selection**. Use **Pr.157 OL signal output timer** to set the OL signal output timing.
- The stall prevention is enabled even during regeneration avoidance operation.
- The regeneration avoidance function cannot decrease the actual deceleration time for the motor to stop. Since the actual deceleration time is determined by the regenerative power consumption performance, consider using a regeneration unit (FR-BU2, BU, FR-BU, FR-CV, FR-HC2, or FR-XC) or a brake resistor (such as the FR-ABR) to decrease the deceleration time.
- When using a regeneration unit (FR-BU2, BU, FR-BU, FR-CV, FR-HC2, or FR-XC) or a brake resistor (such as the FR-ABR) to consume the regenerative power at constant speed, set **Pr.882** = "0 (initial value)" (the regeneration avoidance function is disabled). When consuming the regenerative power at the time of deceleration with the regeneration unit, etc., set **Pr.882** = "2" (enables regeneration avoidance function only at the constant speed).
- When using the regeneration avoidance function under Vector control, noise may be generated from the motor during deceleration. In such case, adjust the gain by performing easy gain tuning, etc. (Refer to [page 254](#).)

« Parameters referred to »

Pr.1 Maximum frequency  page 428

Pr.8 Deceleration time  page 367

Pr.22 Stall prevention operation level  page 431

## 5.16.13 Increased magnetic excitation deceleration

Increase the loss in the motor by increasing the magnetic flux during deceleration. The deceleration time can be reduced by suppressing the stall prevention (overvoltage) (oL).

The deceleration time can further be shortened without a brake resistor. (When a brake resistor is used, the duty can be reduced.)

Pr.	Name	Initial value	Setting range	Description
660 G130	Increased magnetic excitation deceleration operation selection	0	0	Without the increased magnetic excitation deceleration function
			1	With the increased magnetic excitation deceleration function
661 G131	Magnetic excitation increase rate	9999	0 to 40%	Set the increase of excitation.
			9999	The magnetic excitation increase rate is 10% under V/F control and Advanced magnetic flux vector control. The magnetic excitation increase rate is 0% under Real sensorless vector control and Vector control.
662 G132	Increased magnetic excitation current level	100%	0 to 300%	The increased magnetic excitation rate is automatically lowered when the output current exceeds the setting value during increased magnetic excitation deceleration.

5

### ◆ Setting of increased magnetic excitation rate (Pr.660, Pr.661)

- To enable the increased magnetic excitation deceleration, set **Pr.660 Increased magnetic excitation deceleration operation selection** = "1".
- Set the amount of excitation increase in **Pr.661 Magnetic excitation increase rate**. Increased magnetic excitation deceleration will be disabled when **Pr.661** = "0".
- When the DC bus voltage exceeds the increased magnetic excitation deceleration operation level during the deceleration, excitation is increased in accordance with the setting value in **Pr.661**.
- The increased magnetic excitation deceleration will continue even if the DC bus voltage goes under the increased magnetic excitation deceleration operation level during increased magnetic excitation deceleration.

Inverter	Increased magnetic excitation deceleration operation level
200 V class	340 V
400 V class	680 V
With 500 V input	740 V

- When the stall prevention (overvoltage) occurs during the increased magnetic excitation deceleration operation, increase the deceleration time or raise the setting value of **Pr.661**. When the stall prevention (overcurrent) occurs, increase the deceleration time or lower the setting value of **Pr.661**.
- Increased magnetic excitation deceleration is enabled under V/F control, Advanced magnetic flux vector control, Real sensorless vector control (speed control), and Vector control (speed control).

#### NOTE

- Increased magnetic excitation deceleration will be disabled in the following conditions:  
During PM sensorless vector control, power failure stop, orientation control, operation with the FR-HC2, FR-XC (in common bus regeneration mode), or FR-CV, energy saving operation, Optimum excitation control, and stop-on-contact control.

### ◆ Overcurrent prevention function (Pr.662)

- The overcurrent prevention function is enabled under V/F control and Advanced magnetic flux vector control.
- The increased magnetic excitation rate is lowered automatically when the output current exceeds the level set in **Pr.662** during increased magnetic excitation deceleration.

- When the inverter protective function (E.OC[], E.THT) is activated due to increased magnetic excitation deceleration, adjust the level set in **Pr.662**.
- The overcurrent preventive function is disabled when **Pr.662** = "0".

#### NOTE

- When the level set in **Pr.662** is more than the one set in **Pr.22 Stall prevention operation level**, the overcurrent preventive function is activated at the level set in **Pr.22**. (The level set in **Pr.662** is applied when **Pr.22** = "0".)

#### Parameters referred to

- Pr.22 Stall prevention operation level [page 431](#)
- Pr.30 Regenerative function selection [page 724](#)
- Pr.60 Energy saving control selection [page 712](#)
- Pr.162 Automatic restart after instantaneous power failure selection [page 628](#), [page 635](#)
- Pr.270 Stop-on contact/load torque high-speed frequency control selection [page 577](#)
- Pr.261 Power failure stop selection [page 642](#)
- Pr.350 Stop position command selection [page 585](#)

## 5.16.14 Slip compensation



Under V/F control, the slip of the motor is estimated from the inverter output current to maintain the rotation of the motor constant.

Pr.	Name	Initial value	Setting range	Description
245 G203	Rated slip	9999	0.01 to 50%	Set the rated motor slip.
			0, 9999	No slip compensation
246 G204	Slip compensation time constant	0.5 s	0.01 to 10 s	Set the response time of the slip compensation. Reducing the value improves the response, but the regenerative overvoltage (E.OV[]) error is more likely to occur with a larger load inertia.
247 G205	Constant output range slip compensation selection	9999	0	No slip compensation in the constant power range (frequency range higher than the frequency set in <b>Pr.3</b> ).
			9999	Slip compensation is performed in the constant power range.

- Calculate the rated motor slip and set the value in **Pr.245** to enable slip compensation. Slip compensation is not performed when **Pr.245** = "0 or 9999".

$$\text{Rated slip} = \frac{\text{Synchronized speed at the time of base frequency} - \text{rated rotation speed}}{\text{Synchronized speed at the time of base frequency}} \times 100 [\%]$$

#### NOTE

- When the slip compensation is performed, the output frequency may become larger than the set frequency. Set **Pr.1 Maximum frequency** higher than the set frequency.
- Slip compensation will be disabled in the following conditions:  
Stall prevention (oL, OL) operation, regeneration avoidance operation, auto tuning, encoder feedback control operation

#### Parameters referred to



- Pr.1 Maximum frequency [page 428](#)
- Pr.3 Base frequency [page 707](#)

## 5.16.15 Encoder feedback control



This controls the inverter output frequency so that the motor speed is constant to the load variation by detecting the motor speed with the speed detector (encoder) to feed back to the inverter.

A Vector control compatible option is required.

Pr.	Name	Initial value	Setting range	Description	
<b>144</b> <b>M002</b>	<b>Speed setting switchover</b>	4	0, 2, 4, 6, 8, 10, 12, 102, 104, 106, 108, 110, 112	Set the number of motor poles for the encoder feedback control under V/F control.	
<b>285</b> <b>H416</b>	<b>Overspeed detection frequency</b> <sup>*1</sup>	9999	0 to 30 Hz	When the difference between the detected frequency and the output frequency exceeds the set value during encoder feedback control, an inverter fault (E.MB1) is generated.	
			9999	Overspeed detection is disabled.	
<b>359</b> <sup>*2*3</sup> <b>C141</b>	<b>852</b> <sup>*4</sup> <b>C241</b>	1	0	Set when using a motor for which forward rotation (encoder) is clockwise (CW) viewed from the shaft 	Set for the operation at 120 Hz or less.
			100		Set for the operation at a frequency higher than 120 Hz.
			1	Set when using a motor for which forward rotation (encoder) is counterclockwise (CCW) viewed from the shaft.	Set for the operation at 120 Hz or less.
			101		Set for the operation at a frequency higher than 120 Hz.
<b>367</b> <sup>*2</sup> <b>G240</b>	<b>Speed feedback range</b>	9999	0 to 590 Hz	Set the range of speed feedback control.	
			9999	The encoder feedback control is disabled.	
<b>368</b> <sup>*2</sup> <b>G241</b>	<b>Feedback gain</b>	1	0 to 100	Set when the rotation is unstable or response is slow.	
<b>369</b> <sup>*2*3</sup> <b>C140</b>	<b>851</b> <sup>*4</sup> <b>C240</b>	1024	0 to 4096	Set the number of encoder pulses. Set the number of pulses before it is multiplied by 4.	

\*1 The speed deviation excess detection frequency is used when Vector control compatible option is mounted during Vector control. (Refer to page 269 for details.)

\*2 The setting is available when a Vector control compatible option is installed.

\*3 The parameter number is the one for use a Vector control compatible option. (Pr.369 is applicable for the FR-A8AP and FR-A8AL.)

\*4 The parameter number is the one for use with the control terminal option (FR-A8TP).

## ◆ Setting before operation (Pr.144, Pr.359, Pr.369)

- For the operation during encoder feedback control under V/F control, set the number of motor poles in **Pr.144 Speed setting switchover** in accordance with the applied motor. Since the **Pr.81 Number of motor poles** setting is used during Advanced magnetic flux vector, the **Pr.144** setting does not need to be changed.
- Use **Pr.359 Encoder rotation direction** and Pr.369 Number of encoder pulses to set the rotation direction and the number of pulses for the encoder.

### NOTE

- Operating the inverter with **Pr.144** = "0, 10, 12, 110, or 112" causes E.1 to E.3.
- When "102, 104, 106, or 108" is set in **Pr.144**, the value obtained by subtracting 100 from the set value will be set as the number of poles.
- The **Pr.144** setting changes automatically when setting the motor poles in **Pr.81**, but even if **Pr.144** is changed, **Pr.81** will not automatically change.
- Control with correct speed is not possible if the number of poles for the applied motor is incorrect. Check first before operation.
- Encoder feedback control is not possible when the rotation direction setting of the encoder is incorrect. (Operation of the inverter is possible.)  
Check the indicator on the parameter unit to confirm the direction.

## ◆ Selection of encoder feedback control (Pr.367)

- When a value other than "9999" is set in **Pr.367 Speed feedback range**, encoder feedback control is enabled. Set a target value (frequency at which stable speed operation is performed) and specify the range around the value. Normally, use the frequency converted from the slip amount (r/min) at the rated motor speed (rated load). If the setting is too large, response becomes slow.

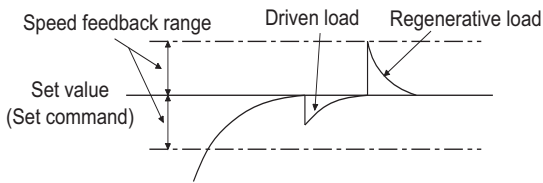

- Example: when the rated speed of a motor (4 poles) is 1740 r/min at 60 Hz

$$\begin{aligned} \text{Slip } N_{sp} &= \text{Synchronous speed} - \text{Rated speed} \\ &= 1800 - 1740 \\ &= 60 \text{ (r/min)} \end{aligned}$$

$$\begin{aligned} \text{Frequency equivalent to slip (fsp)} &= N_{sp} \times \text{Number of poles}/120 \\ &= 60 \times 4/120 \\ &= 2 \text{ (Hz)} \end{aligned}$$

## ◆ Feedback gain (Pr.368)

- Set **Pr.368 Feedback gain** when the rotation is unstable or response is slow.
- Response of the feedback will become slow when the acceleration/deceleration time is long. In such case, increase the setting value of **Pr.368**.

Pr.368 setting	Description
Pr.368 > 1	Response will become faster but it may cause overcurrent or unstable operation.
1 > Pr.368	Response will become slower but the operation will become more stable.

## ◆ Overspeed detection (Pr.285)

- To prevent malfunction when the correct pulse signal cannot be detected from the encoder, when [detection frequency] - [output frequency]  $\geq$  **Pr.285** during encoder feedback control, a protective function (E.MB1) will be activated to shut off the inverter output.
- Overspeed detection is not performed when **Pr.285** = "9999".

### NOTE

- Couple the encoder on the same axis as the motor axis without any mechanical clatter, with speed ratio of 1:1.
- Encoder feedback control is not performed during the acceleration and deceleration to prevent unstable operation such as hunting.
- Encoder feedback control is performed after the output frequency has reached [set frequency]  $\pm$  [speed feedback range] once.
- When following status occurs during encoder feedback control operation, the inverter output is not shut off, the output frequency becomes the value obtained by [set frequency]  $\pm$  [speed feedback range], and tracking of the motor speed is not performed.
  - When the pulse signal from the encoder is lost due to a break, etc.
  - When correct pulse signal cannot be detected due to induction noise, etc.
  - When the motor is forcefully accelerated (regenerative rotation) or decelerated (motor lock) due to large external force
- Use the Inverter running (RUN) signal when releasing the brake from the motor with a brake. (The brake may not be released when the Output frequency detection (FU) signal is used.)
- Do not turn OFF the external power supply for the encoder during encoder feedback control. Normal encoder feedback control will not be possible.

### ◀ Parameters referred to ▶

Pr.81 Number of motor poles page 221, page 532

## 5.16.16 Droop control

**Magnetic flux** **Sensorless** **Vector** **PM**

This is a function to give droop characteristics to the speed by balancing the load in proportion with the load torque during the Advanced magnetic flux vector control, Real sensorless vector control, Vector control, and PM sensorless vector control.



This is effective in balancing the load when multiple inverters are connected.

Pr.	Name	Initial value	Setting range	Description	
286 G400	Droop gain	0%	0	Normal operation	
			0.1 to 100%	Droop control enabled. Set the droop amount at the time of rated torque as % value of the rated motor frequency.	
287 G401	Droop filter time constant	0.3 s	0 to 1 s	Set the time constant of the filter relative to the torque current.	
288 G402	Droop function activation selection	0	0	No droop control during acceleration/deceleration (with 0 limit)	The Pr.84 setting is the droop compensation reference.
			1	Continuous droop control during operation (with 0 limit)	
			2	Continuous droop control during operation (without 0 limit)	The motor speed is the droop compensation reference.
			10	No droop control during acceleration/deceleration (with 0 limit)	
			11	Continuous droop control during operation (with 0 limit)	The Pr.1121 setting is the droop compensation reference.
			20	No droop control during acceleration/deceleration (with 0 limit)	
			21	Continuous droop control during operation (with 0 limit)	
			22	Continuous droop control during operation (without 0 limit)	
994 G403	Droop break point gain	9999	0.1 to 100%	Set the droop amount to be changed as % value of the rated motor frequency.	
			9999	No function	
995 G404	Droop break point torque	100%	0.1 to 100%	Set the torque to change the droop amount.	
679 G420	Second droop gain	9999	0 to 100%	Refer to Pr.286.	Set the second droop control. The second droop control is enabled when the RT signal is ON.
			9999	The first droop control setting is applied.	
680 G421	Second droop filter time constant	9999	0 to 1 s	Refer to Pr.287.	
			9999	The first droop control setting is applied.	
681 G422	Second droop function activation selection	9999	0 to 2, 10, 11, 20 to 22	Refer to Pr.288.	
			9999	The first droop control setting is applied.	
682 G423	Second droop break point gain	9999	0.1 to 100%	Refer to Pr.994.	
			9999	The first droop control setting is applied.	
683 G424	Second droop break point torque	9999	0.1 to 100%	Refer to Pr.995.	
			9999	The first droop control setting is applied.	

## ◆ Droop control

- Droop control is enabled under Advanced magnetic flux vector control, Real sensorless vector control, Vector control, and PM sensorless vector control.
- In the droop control, the speed command changes depending on the amount of the current for torque.  
Set the droop amount at the rated torque in Droop gain as % value of the rated motor frequency (or motor speed when Pr.288 = "10 or 11").
- The upper limit of the droop compensation frequency is 400 Hz or Pr.1 Maximum frequency, whichever smaller.



- During PM sensorless vector control, the upper limit of the droop compensation frequency is 400 Hz, the frequency set in **Pr.1**, or the maximum motor frequency, whichever the smallest.

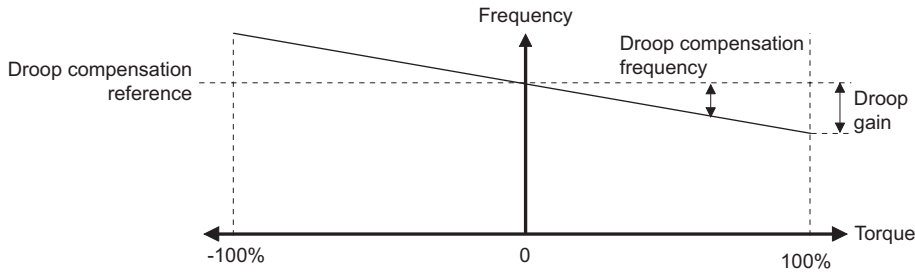

- The droop compensation frequency is calculated as follows.

$$\text{Droop compensation frequency} = \frac{\text{Current for torque after filtering}}{\text{Rated torque current}} \times K \times \frac{\text{Droop compensation reference} \times \text{Droop gain}}{100}$$

When the output frequency is equal to or lower than the rated frequency set in **Pr.84**:  $K=1$

When the output frequency is higher than the rated frequency set in **Pr.84**:  $K = \frac{\text{Rated frequency (Pr.84)}}{\text{Output frequency}}$

### NOTE

- Set the droop gain equivalent to the rated slip of the motor.

$$\text{Rated slip} = \frac{\text{Synchronized speed at the time of base frequency} - \text{rated rotation speed}}{\text{Synchronized speed at the time of base frequency}} \times 100[\%]$$

- The speed loop integration can be disabled at the emergency stop using **Pr.1349 Emergency stop operation selection**. (Refer to [page 367](#).)

## ◆ Limiting the frequency after the droop compensation (0 limit)

- Under Real sensorless vector control, Vector control, or PM sensorless vector control, the lower limit can be set for the frequency command value by setting **Pr.288** when the value falls below zero after droop compensation.

Pr.288 setting	Operation	When the output frequency after droop compensation is negative	Droop compensation reference
0 (initial value)	No droop control during acceleration/deceleration	Limited at 0 Hz (limited at 0.5 Hz under Advanced magnetic flux vector control)	Rated motor frequency ( <b>Pr.84</b> setting)
10 <sup>*1</sup>			Motor speed
20 <sup>*1</sup>			Per-unit speed control reference frequency ( <b>Pr.1121</b> setting)
1 <sup>*1</sup>	Continuous droop control during operation		Rated motor frequency ( <b>Pr.84</b> setting)
11 <sup>*1</sup>			Motor speed
21 <sup>*1</sup>			Per-unit speed control reference frequency ( <b>Pr.1121</b> setting)
2 <sup>*1</sup>	Continuous droop control during operation	<ul style="list-style-type: none"> <li>• Not limited (but reversed) under Vector control or PM sensorless vector control</li> <li>• Limited at 0 Hz under Real sensorless vector control</li> </ul>	Rated motor frequency ( <b>Pr.84</b> setting)
22 <sup>*1</sup>			Per-unit speed control reference frequency ( <b>Pr.1121</b> setting)

\*1 Under Advanced magnetic flux vector control, the operation is the same as the one when the setting is "0".

## ◆ Setting the break point for droop control (Pr.994, Pr.995)

- Set **Pr.994** and Pr.995 to have a break point on a droop compensation frequency line. Setting a break point allows the inverter to raise the droop compensation frequency for light-load (no load) operation without raising it for heavy-load operation.

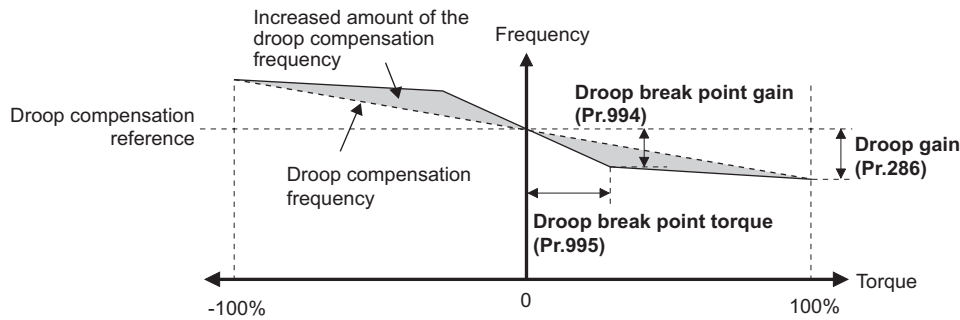

### NOTE

- The droop break point function is disabled when any of the following conditions is met. (Linear compensation by **Pr.286** is performed.)

$$\text{Pr.995} = 100\% \text{ (initial value)}$$

$$\text{Pr.286} < \text{Pr.994}$$

$$\text{Pr.994} \leq \text{Pr.995} \times \text{Pr.286} / 100\%$$

## ◆ Setting multiple droop control types (Pr.679 to Pr.683)

- When the second droop control is set, two sets of droop controls can be switched for use. Turning ON the Second function selection (RT) signal enables the second droop control.

### NOTE

- The RT signal is the Second function selection signal which also enables other second functions.
- The RT signal is assigned to terminal RT in the initial status. Set "3" in one of **Pr.178 to Pr.189 (Input terminal function selection)** to assign the RT signal to another terminal.
- Changing the terminal assignment using **Pr.178 to Pr.189 (Input terminal function selection)** may affect the other functions. Set parameters after confirming the function of each terminal.

### Parameters referred to

Pr.1 Maximum frequency [page 428](#)

Pr.178 to Pr.189 Input terminal function selection [page 521](#)

## 5.16.17 Speed smoothing control



The output current (torque) of the inverter sometimes becomes unstable due to vibration caused by mechanical resonance. Such vibration can be suppressed by reducing fluctuation of the output current (torque) by changing the output frequency.

Pr.	Name	Initial value	Setting range	Description
653 G410	Speed smoothing control	0%	0 to 200%	Check the effect by increasing and decreasing the value at around 100%.
654 G411	Speed smoothing cutoff frequency	20 Hz	0 to 120 Hz	Set the minimum frequency for the torque variation cycle.

## ◆ Control block diagram

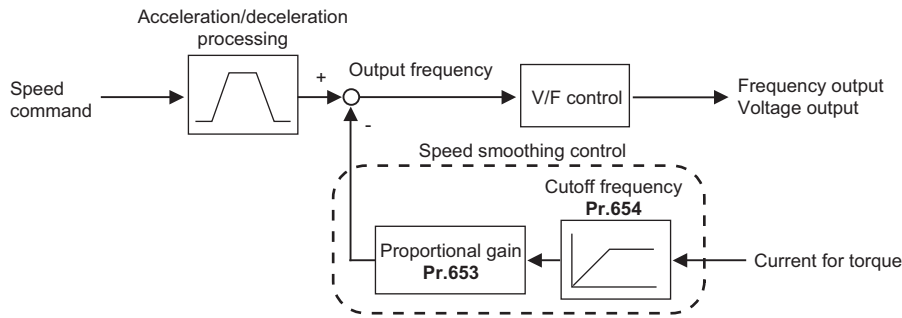

## ◆ Setting method

- When vibration caused by mechanical resonance occurs, set 100% in **Pr.653 Speed smoothing control**, perform operation at the frequency with the largest vibration, and check if the vibration is suppressed after few seconds.
- If the setting is not effective, gradually increase the value set in **Pr.653** and repeat the operation to check the effect to determine the most effective value (**Pr.653**).
- If the vibration increases by increasing the value in **Pr.653**, decrease the value in **Pr.653** from 100% to check the effect.
- When the vibrational frequency at which mechanical resonance occurs (during fluctuation of torque, speed, or converter output voltage) is measured using an instrument such as a tester, set 1/2 to 1 times of the vibrational frequency in **Pr.654 Speed smoothing cutoff frequency**. (Setting the resonance frequency range mitigates vibration more effectively.)

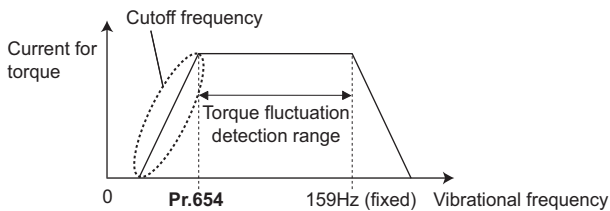

### NOTE









- Depending on the equipment, the vibration may not be suppressed sufficiently or the setting is not effective.

# 5.17 Parameter clear / All parameter clear

**Point**



- Set "1" to **Pr.CLR Parameter clear** or **ALL.CL All parameter clear** to initialize all parameters. (Parameters cannot be cleared when **Pr.77 Parameter write selection** = "1".)
- Pr.CLR does not clear calibration parameters or the terminal function selection parameters.
- Refer to the parameter list on [page 864](#) for parameters cleared with this operation.

## Operating procedure

1. Turning ON the power of the inverter  
The operation panel is in the monitor mode.
2. Changing the operation mode  
Press  to choose the PU operation mode. The [PU] indicator turns ON.
3. Selecting the parameter setting mode  
Press  to choose the parameter setting mode. (The parameter number read previously appears.)
4. Selecting the parameter  
Turn  to "Pr.CLR" for Parameter clear or turn it to "ALLCL" for All parameter clear, and press . "0 (initial value)" appears.
5. Parameter clear  
Turn  to change the set value to "1". Press  to set. "1" and "Pr.CLR" ("ALLCL") are displayed alternately after parameters are cleared.
  - Turn  to read another parameter.
  - Press  to show the setting again.
  - Press  twice to show the next parameter.

Setting	Description	
	Pr.CL Parameter clear	ALL.CL All parameter clear
0	Initial display (Parameters are not cleared.)	
1	The settings of parameters except for calibration parameters and terminal function selection parameters are initialized.	The settings of all the parameters, including calibration parameters and terminal function selection parameters, are initialized.

**NOTE**

- "1" and "Er-4" are displayed alternately when the operation mode is other than the PU operation mode.
  - 1) Press .  
 turns ON, and "1" appears on the monitor. (When **Pr.79** = "0" (initial value))
  - 2) Press  to clear the parameter.
- Stop the inverter first. Writing error occurs if parameter clear is attempted while the inverter is running.
- To clear parameters, the inverter must be in the PU operation mode even if "2" is set to **Pr.77**.
- For availability of the Parameter clear or All parameter clear operation for each parameter, refer to the parameter list on [page 864](#).

# 5.18 Copying and verifying parameters on the operation panel

Pr.CPY setting value	Description
0.---	Initial display
1.RD	Copy the parameters from the source inverter to the operation panel.
2.WR	Write the parameters stored in the operation panel to the target inverter.
3.VFY	Verify parameters in the inverter and operation panel. (Refer to <a href="#">page 746.</a> )

### NOTE

- When the copy destination is other than the FR-A800 series or when parameter copy is attempted after the parameter copy reading was stopped, the product series error "r-E4" appears.
- Refer to the parameter list on [page 864](#) for the availability of parameter copy.
- When the power is turned OFF or an operation panel is disconnected, etc. during parameter copy writing, write again or check the setting values by parameter verification.
- When parameters are copied from a different-capacity inverter, there are parameters with different initial values depending on the inverter capacity, so the setting values of some parameters will be automatically changed. After performing a parameter copy from a different-capacity inverter, check all the parameter settings. (Refer to the parameter list ([page 166](#)) for details on parameters with different initial values depending on individual inverter capacity.)
- While password protection is enabled, parameter copy and parameter verification cannot be performed. (Refer to [page 348.](#))
- If parameters are copied from an older inverter to a newer inverter that has additional parameters, out-of-range setting values may be written in some parameters. In that case, those parameters operate as if they were set to initial values.

## 5.18.1 Parameter copy

- Inverter parameter settings can be copied to another inverter.

### ◆ Reading the parameter settings in the inverter and storing them in the operation panel



#### Operating procedure

1. Connect the operation panel to the source inverter.

2. Selecting the parameter setting mode

Press  to choose the parameter setting mode. (The parameter number read previously appears.)

3. Selecting the parameter

Turn  to "Pr.CPY" (Parameter copy) and press .

"0.---" appears.

4. Reading to and storing in the operation panel

Turn  to change the set value to "RD". Press  to start reading the parameter settings by the operation panel. (It takes about 30 seconds to read and store all the settings. During reading, "RD" blinks.)

5. End of reading and storing







"RD" and "Pr.CPY" are displayed alternately after the reading and storing are completed.

### NOTE

- "r-E1" appears when a parameter read error occurred. Perform the operation from step 3 again.

## ◆ Copying parameter settings stored in the operation panel to the inverter

### Operating procedure

1. Connect the operation panel to the destination inverter.
2. Selecting the parameter setting mode  
Press  to choose the parameter setting mode. (The parameter number read previously appears.)
3. Selecting the parameter  
Turn  to "Pr.CPY" (Parameter copy), and press .  
"0. -- -- --" appears.
4. Selecting parameter copy  
Turn  to change the set value to "2WR", then press .  
"2. ALL" appears.
5. Copying to the inverter  
Press  to start copying to the inverter. (It takes about 60 seconds to copy all the settings. During copying, "2. ALL" blinks.)  
• Perform this step while the inverter is stopped. (Parameter settings cannot be copied during operation.)
6. End of copying  
"2WR" and "Pr.CPY" are displayed alternately after copying ends.
7. When parameters are written to the destination inverter, reset the inverter before operation by, for example, turning the power supply OFF.

### NOTE

- "rE2" appears when a parameter write error occurred. Perform the operation from step 3 again.
- "CP" and "0.00" are displayed alternately when parameter copy is performed between the FR-A820-03160(55K) or lower or FR-A840-01800(55K) or lower inverters and the FR-A820-03800(75K) or higher or FR-A840-02160(75K) or higher inverters. When CP and 0.00 are displayed alternately, set **Pr.989 Parameter copy alarm release** as shown in the following table (initial value).







Pr.989 setting	Operation
10	Cancels the warning of FR-A820-03160(55K) or lower and FR-A840-01800(55K) or lower.
100	Cancels the warning of FR-A820-03800(75K) or higher and FR-A840-02160(75K) or higher.

- After setting **Pr.989**, perform setting of **Pr.9, Pr.30, Pr.51, Pr.56, Pr.57, Pr.61, Pr.70, Pr.72, Pr.80, Pr.82, Pr.90 to Pr.94, Pr.453, Pr.455, Pr.458 to Pr.462, Pr.557, Pr.859, Pr.860**, and Pr.893 again.

## 5.18.2 Parameter verification

- Whether the parameter settings of inverters are the same or not can be checked.

### Operating procedure

1. Copy the parameter settings of the verification source inverter to the operation panel according to the procedure on [page 744](#).
2. Detach the operation panel from the source inverter and attach it to the verification target inverter.
3. Turning ON the power of the inverter  
The operation panel is in the monitor mode.
4. Selecting the parameter setting mode  
Press  to choose the parameter setting mode. (The parameter number read previously appears.)
5. Selecting the parameter  
Turn  to "Pr.CPY" (Parameter copy) and press .  
"0. -- -- --" appears.
6. Parameter verification  
Turn  to change to setting value "31.F4" (Parameter copy verification mode).  
Press . Verification of the parameter settings copied to the operation panel and the parameter settings of the verification destination inverter is started. (It takes about 60 seconds to verify all the settings. During verification, "31.F4" blinks.)
  - If there are different parameters, the different parameter number and "r-E3" are displayed alternately.
  - To continue verification, press .
7. "Pr.CPY" and "31.F4" are displayed alternately after verification ends.

### NOTE

- When "r-E3" blinks, the set frequency may be incorrect. To continue verification, press .

# 5.19 Copying and verifying parameters using a USB memory

- Inverter parameter settings can be copied to a USB memory device.
- Parameter setting data stored in a USB memory device can be copied to another inverter or verified to see if they differ from the parameter settings of another inverter.
- Parameter settings can also be imported to a personal computer and edited in FR Configurator2.

## ◆ Changes in the USB memory copy operation states

- Insert the USB memory device into the inverter. The USB memory mode is displayed and the USB memory operations are enabled.

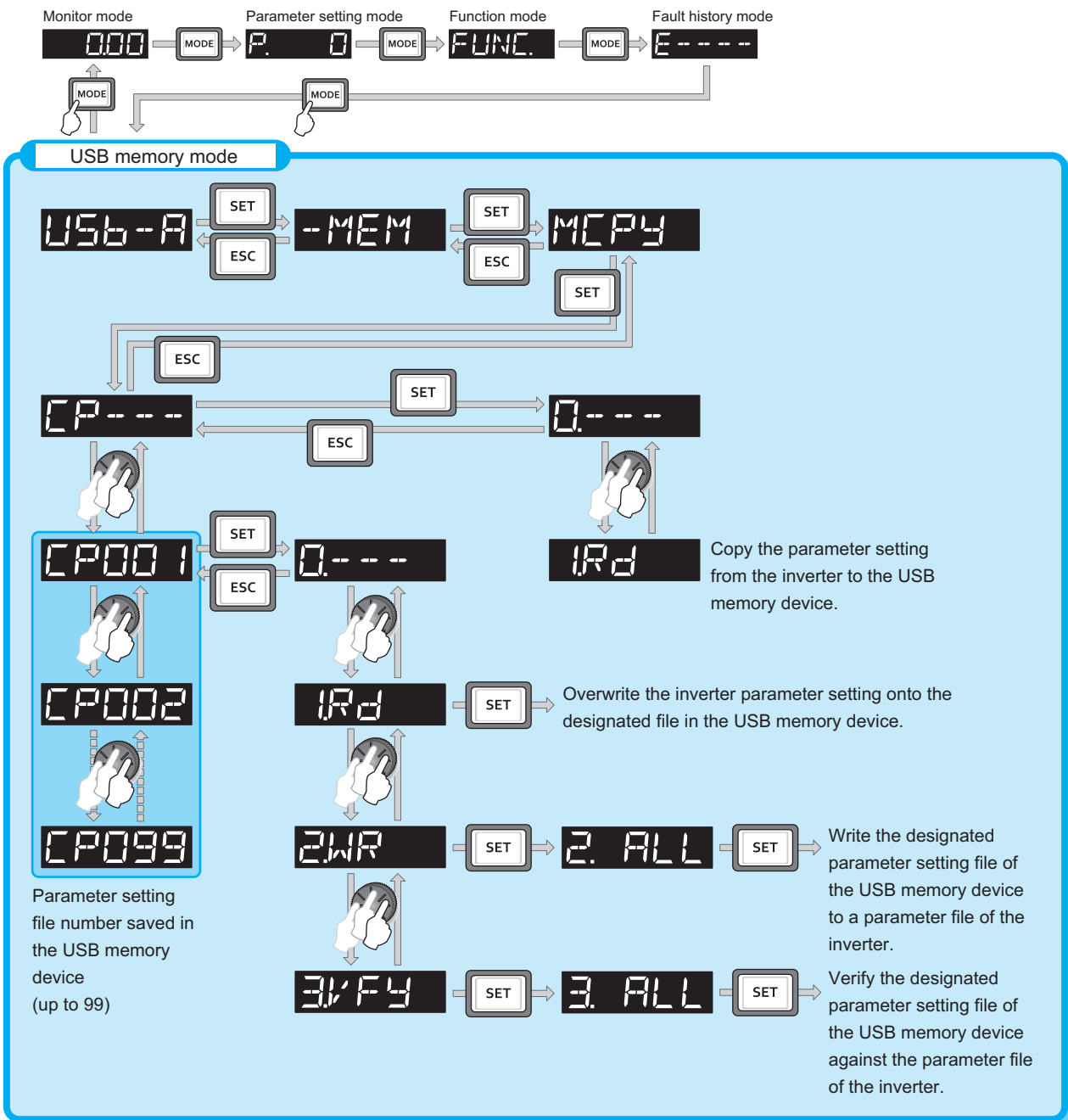





## NOTE

- When parameter settings are copied to the USB memory without specifying a parameter setting file number in the USB memory, numbers are automatically assigned.
- Up to 99 files can be saved in the USB memory. When the USB memory already has 99 files, attempting copying of another file to the USB memory causes the file quantity error (rE7).
- Refer to the Instruction Manual of FR Configurator2 for the details on importing files to FR Configurator2.
- While password protection is enabled, parameter copy and parameter verification cannot be performed. (Refer to [page 348](#).)



## ◆ Procedure for copying parameters to the USB memory

### Operating procedure

1. Insert the USB memory device into the copy source inverter.
2. USB memory mode  
Press **MODE** to change to the USB memory mode.
3. Displaying the file selection screen  
Press **SET** three times to display "CP -- -- --" (file selection screen) and press **SET**. (To overwrite files on the USB memory, display the file selection screen, turn  to select the file number, and press **SET**.)
4. Copying to the USB memory  
Turn  to change to "IRD". Press **SET** to copy the parameter settings at the copy source to the USB memory. (It takes about 15 seconds to copy all the settings. During copying, "IRD" blinks.)  
"IRD" and the file number are displayed alternately after copying ends.

## ◆ Procedure for copying parameters from the USB memory to the inverter

### Operating procedure

1. Insert the USB memory device into the destination inverter.
2. USB memory mode  
Press **MODE** to change to the USB memory mode.
3. Displaying the file selection screen  
Press **SET** three times to display "CP -- -- --" (file selection screen).
4. Selecting the file number  
Turn  to select the file number to copy to the inverter, and press **SET**.
5. Turn  to display "2WR" and press **SET**. "2. ALL" appears.
6. Writing to the inverter  
Press **SET** to start writing the parameter settings stored in the USB memory to the destination inverter. (It takes about 15 seconds to copy all the settings. During copying, "2. ALL" blinks.)  
"2. ALL" and the file number are displayed alternately after copying ends.
  - Perform this step while the inverter is stopped.
7. When parameters are written to the destination inverter, reset the inverter before operation by, for example, turning the power supply OFF.









- "r-E 1" or "r-E 2" appears when a USB memory device error occurred. Check the connection of the USB memory device and try the operation again.
- "CP" and "000" are displayed alternately when parameter copy is performed between the FR-A820-03160(55K) or lower or FR-A840-01800(55K) or lower inverters and the FR-A820-03800(75K) or higher or FR-A840-02160(75K) or higher inverters. When CP and 0.00 are displayed alternately, set **Pr.989 Parameter copy alarm release** as shown below (initial value).

Pr.989 setting	Operation
10	Cancels the warning of FR-A820-03160(55K) or lower and FR-A840-01800(55K) or lower.
100	Cancels the warning of FR-A820-03800(75K) or higher and FR-A840-02160(75K) or higher.

- After setting **Pr.989**, perform setting of **Pr.9, Pr.30, Pr.51, Pr.56, Pr.57, Pr.61, Pr.70, Pr.72, Pr.80, Pr.82, Pr.90 to Pr.94, Pr.453, Pr.455, Pr.458 to Pr.462, Pr.557, Pr.859, Pr.860**, and Pr.893 again.
- When the destination inverter is other than the FR-A800 series or when Parameter copy is attempted after the parameter copy reading was stopped, the model error "r-E 4" appears.
- Refer to the parameter list on [page 864](#) for the availability of parameter copy.
- When the power is turned OFF or an operation panel is disconnected, etc. during parameter copy writing, write again or check the setting values by parameter verification.
- When parameters are copied from a different-capacity inverter, there are parameters with different initial values depending on the inverter capacity, so the setting values of some parameters will be automatically changed. After performing a parameter copy from a different-capacity inverter, check all the parameter settings. (Refer to the parameter list ([page 166](#)) for details on parameters with different initial values depending on individual inverter capacity.)

## ◆ Procedure for verifying parameters in the USB memory

### Operating procedure

1. Copy the parameter settings of the verification source inverter to the USB memory according to the procedure on [page 748](#).
2. Move the USB memory device to the inverter to be verified.
3. Turning ON the power of the inverter  
The operation panel is in the monitor mode.
4. USB memory mode  
Press  to change to the USB memory mode.
5. Displaying the file selection screen  
Press  three times to display "CP -- -- --" (file selection screen).
6. Selecting the file number  
Turn  to select the file number to be verified, and press .
7. Parameter verification  
Turn  to display the setting "31FY" (Parameter copy verification mode), and press   
"3. ALL" appears.  
Press  to start verification of the parameter settings copied to the USB memory and the parameter settings of the verification destination inverter. (It takes about 15 seconds to verify all the settings. During verification, "3. ALL" blinks.)
  - If there are different parameters, the different parameter number and "r-E 3" are displayed alternately.
  - To continue verification, press .

8. The verified file number and "3. ALL" are displayed alternately after verification ends.







 **NOTE**

- When "r-EE" blinks, the set frequency may be incorrect. To continue verification, press .

# 5.20 Checking parameters changed from their initial values (initial value change list)

Parameters changed from their initial values can be displayed.

## Operating procedure

1. Turning ON the power of the inverter  
The operation panel is in the monitor mode.
2. Selecting the parameter setting mode  
Press  to choose the parameter setting mode. (The parameter number read previously appears.)
3. Selecting a parameter  
Turn  to "Pr-CHG" (Initial value change list), and press .  
"Pr. -- -- --" appears.
4. Checking the Initial value change list  
Turn . The parameter numbers that have been changed from their initial value appear in order.
  - When  is pressed with a changed parameter displayed, the parameter settings can be changed as they are. (Parameter numbers are no longer displayed in the list when they are returned to their initial values.)Other changed parameters appear by turning .
  - The indication returns to "Pr. -- -- --" when the last changed parameter is displayed.

### NOTE

- The calibration parameters (C0 (Pr.900) to C7 (Pr.905), C42 (Pr.934) to C45 (Pr.935)) are not displayed even when these are changed from the initial settings.
- Only the simple mode parameters are displayed when the simple mode is set (Pr.160 ="9999").
- Only user groups are displayed when user groups are set (Pr.160 ="1").
- Pr.160 is displayed independently of whether the setting value is changed or not.
- Parameter setting using the Initial value change list is also possible.

# 5.21 CC-Link IE Field Network (FR-A800-GF)

## 5.21.1 Cyclic transmission

Data communication is available periodically among stations on the same network. Link devices (RX, RY, RWr, and RWw) are used.

### ◆ Data flow and link device assignment (master and slave stations (except for local stations))

One-to-one communication is possible between the master and slave stations.

The status information of the link devices (RY and RWw) of the master station is output to the external device of the slave station, and the input status information from the external device of the slave station is stored in the link devices (RX and RWr) of the master station.

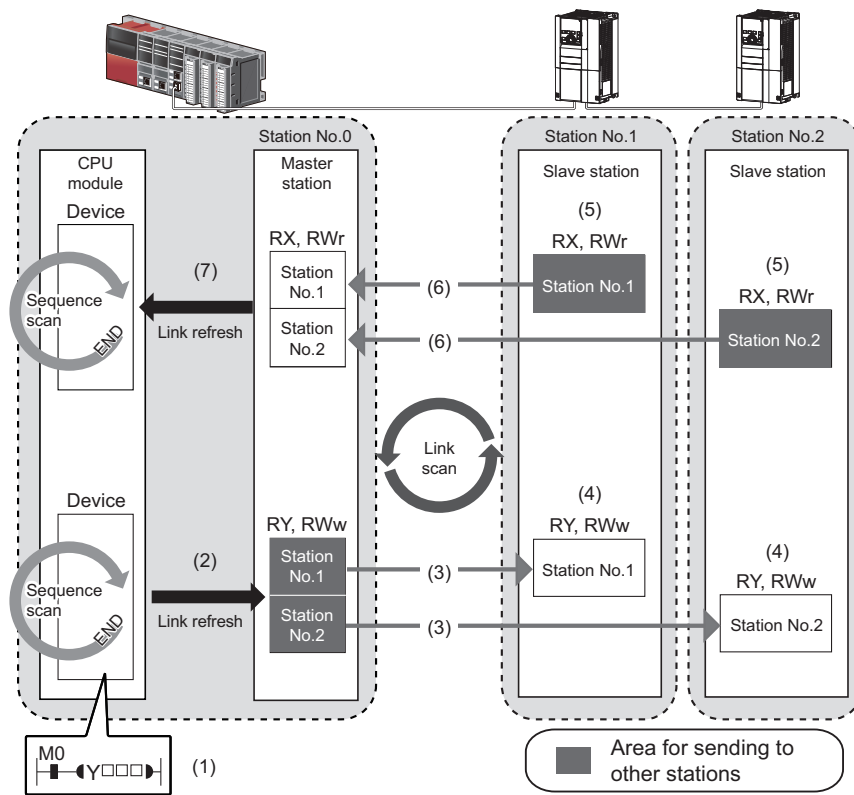

Status	No.	Description
Output from the master station	(1)	The device of the CPU module turns ON.
	(2)	The device status data of the CPU module are stored in the link devices (RY and RWw) of the master station by link refresh.
	(3)	The status data of the link devices (RY and RWw) of the master station are stored in the link devices (RY and RWw) of each slave station by link scan.
	(4)	The inverter starts according to the link device (RY and RWw) conditions (input signals such as STF and STR) of the slave station.
Input from the slave station	(5)	Inverter conditions (output signals such as RUN and SU, monitoring) are stored in the link devices (RX and RWr) of the slave station.
	(6)	The status data of the link devices (RX and RWr) of the slave station are stored in the link devices (RX and RWr) of the master station by link scan.
	(7)	The status data of the link devices (RX and RWr) of the master station are stored in the devices of the CPU module by link refresh.

**NOTE**

- Refer to the MELSEC iQ-R, MELSEC-Q, or MELSEC-L CC-Link IE Field Network Master/Local Module User's Manual for the detailed assignment methods for the link devices and link refresh.

## 5.21.2 I/O signal list

### ◆ Remote I/O (64 points (fixed))

Device No. <sup>*5</sup>	Signal	Refer to page	Device No. <sup>*5</sup>	Signal	Refer to page
RYn0	Forward rotation command <sup>*2</sup>	756	RXn0	Forward running	758
RYn1	Reverse rotation command <sup>*2</sup>	756	RXn1	Reverse running	758
RYn2	High-speed operation command (terminal RH function) <sup>*1</sup>	756	RXn2	Running (terminal RUN function) <sup>*3</sup>	758
RYn3	Middle-speed operation command (terminal RM function) <sup>*1</sup>	756	RXn3	Up to frequency (terminal SU function) <sup>*3</sup>	758
RYn4	Low-speed operation command (terminal RL function) <sup>*1</sup>	756	RXn4	Overload alarm (terminal OL function) <sup>*3</sup>	758
RYn5	Jog operation selection (terminal JOG function) <sup>*1</sup>	756	RXn5	Instantaneous power failure (terminal IPF function) <sup>*3</sup>	758
RYn6	Second function selection (terminal RT function) <sup>*1</sup>	756	RXn6	Frequency detection (terminal FU function) <sup>*3</sup>	758
RYn7	Current input selection (terminal AU function) <sup>*1</sup>	756	RXn7	Error (terminal ABC1 function) <sup>*3</sup>	758
RYn8	Selection of automatic restart after instantaneous power failure (terminal CS function) <sup>*1</sup>	756	RXn8	— (terminal ABC2 function) <sup>*3</sup>	758
RYn9	Output stop (terminal MRS function) <sup>*1</sup>	756	RXn9 to RXnF	Reserved	—
RYnA	Start self-holding selection (terminal STOP function) <sup>*1</sup>	756			
RYnB	Reset (terminal RES function) <sup>*1</sup>	756	RX(n+1)0	<b>Pr.313</b> assignment function (DO0) <sup>*4</sup>	758
RYnC to RYnF	Reserved	—	RX(n+1)1	<b>Pr.314</b> assignment function (DO1) <sup>*4</sup>	758
RY(n+1)0 to RY(n+1)2			RX(n+1)2	<b>Pr.315</b> assignment function (DO2) <sup>*4</sup>	758
RY(n+1)3 to RY(n+1)F	Reserved	—	RX(n+1)3 to RX(n+1)F	Reserved	—
RY(n+2)0	Monitor command	756	RX(n+2)0	Monitoring	758
RY(n+2)1	Frequency setting command (RAM)	756	RX(n+2)1	Frequency setting completion (RAM)	758
RY(n+2)2	Frequency setting command (RAM, EEPROM)	756	RX(n+2)2	Frequency setting completion (RAM, EEPROM)	758
RY(n+2)3	Torque command / torque limit (RAM)	757	RX(n+2)3	Torque command / torque limit setting completion (RAM)	758
RY(n+2)4	Torque command / torque limit (RAM, EEPROM)	757	RX(n+2)4	Torque command / torque limit setting completion (RAM, EEPROM)	758
RY(n+2)5	Instruction code execution request	757	RX(n+2)5	Instruction code execution completed	758
RY(n+2)6 to RY(n+3)9	Reserved	—	RX(n+2)6 to RX(n+3)9	Reserved	—
RY(n+3)A	Error reset request flag	757	RX(n+3)A	Error status flag	758
RY(n+3)B to RY(n+3)F	Reserved	—	RX(n+3)B	Remote station ready	758
			RX(n+3)C to RX(n+3)F	Reserved	—

\*1 These signals are set in the initial setting. Using **Pr.180 to Pr.189**, input signals assigned to the device numbers can be changed. (Refer to [page 521](#).)

\*2 The signals are fixed. They cannot be changed using parameters.

\*3 These signals are set in the initial setting. Using **Pr.190 to Pr.196**, output signals assigned to the device numbers can be changed. (Refer to [page 473](#).)

\*4 Output signal can be assigned using **Pr.313 to Pr.315**. (Refer to [page 473](#).)

\*5 "n" indicates a value determined by the station number setting.

## ◆ Remote register (128 words (fixed))

Address <sup>*3</sup>	Description		Refer to page
	Upper 8 bits	Lower 8 bits	
RWwn	Set frequency (0.01 Hz increments)		759
RWwn+1	Reserved		—
RWwn+2	Torque command / torque limit		759
RWwn+3	Reserved		—
RWwn+4	PID set point (0.01% increments) <sup>*1</sup>		759
RWwn+5	PID measured value (0.01% increments) <sup>*1</sup>		759
RWwn+6	PID deviation (0.01% increments) <sup>*1</sup>		759
RWwn+7 to RWwn+F	Reserved		—
RWwn+10	Link parameter extended setting	Instruction code <sup>*2</sup>	759
RWwn+11	Write data		759
RWwn+12	Link parameter extended setting	Instruction code <sup>*2</sup>	759
RWwn+13	Write data		759
RWwn+14	Link parameter extended setting	Instruction code <sup>*2</sup>	759
RWwn+15	Write data		759
RWwn+16	Link parameter extended setting	Instruction code <sup>*2</sup>	759
RWwn+17	Write data		759
RWwn+18	Link parameter extended setting	Instruction code <sup>*2</sup>	759
RWwn+19	Write data		759
RWwn+1A	Link parameter extended setting	Instruction code <sup>*2</sup>	759
RWwn+1B	Write data		759
RWwn+1C to RWwn+1F	Reserved		—
RWwn+20	Reserved		—
RWwn+21	Fault history No.		759
RWwn+22 to RWwn+25	Reserved		—
RWwn+26	Monitor code 1		759
RWwn+27	Monitor code 2		759
RWwn+28	Monitor code 3		759
RWwn+29	Monitor code 4		759
RWwn+2A	Monitor code 5		759
RWwn+2B	Monitor code 6		759
RWwn+2C	Monitor code 7		759
RWwn+2D	Monitor code 8		759
RWwn+2E	Monitor code 9		759
RWwn+2F	Monitor code 10		759
RWwn+30 to RWwn+39	Reserved		—

Address <sup>*3</sup>	Description		Refer to page
	Upper 8 bits	Lower 8 bits	
RWrn	Reply code		760
RWrn+1	Reserved		—
RWrn+2	Reply code		760
RWrn+3	Reserved		—
RWrn+4	Reply code		760
RWrn+5	Reply code		760
RWrn+6	Reply code		760
RWrn+7 to RWrn+F	Reserved		—
RWrn+10	Reply code		760
RWrn+11	Read data <sup>*2</sup>		760
RWrn+12	Reply code		760
RWrn+13	Read data <sup>*2</sup>		760
RWrn+14	Reply code		760
RWrn+15	Read data <sup>*2</sup>		760
RWrn+16	Reply code		760
RWrn+17	Read data <sup>*2</sup>		760
RWrn+18	Reply code		760
RWrn+19	Read data <sup>*2</sup>		760
RWrn+1A	Reply code		760
RWrn+1B	Read data <sup>*2</sup>		760
RWrn+1C to RWrn+1F	Reserved		—
RWrn+20	Error status		760
RWrn+21	Fault history No.	Fault record (fault data)	760
RWrn+22	Fault record (output frequency)		760
RWrn+23	Fault record (output current)		760
RWrn+24	Fault record (output voltage)		760
RWrn+25	Fault record (energization time)		760
RWrn+26	First monitor value		760
RWrn+27	Second monitor value		760
RWrn+28	Third monitor value		760
RWrn+29	Fourth monitor value		760
RWrn+2A	Fifth monitor value		760
RWrn+2B	Sixth monitor value		760
RWrn+2C	Seventh monitor value		760
RWrn+2D	Eighth monitor value		760
RWrn+2E	Ninth monitor value		760
RWrn+2F	Tenth monitor value		760
RWrn+30	Output frequency		760
RWrn+31	Reserved		—
RWrn+32	Output current		760
RWrn+33	Output voltage		760
RWrn+34	Reserved		—
RWrn+35	Frequency setting value		760
RWrn+36	Motor speed		760
RWrn+37	Motor torque		760
RWrn+38	Converter output voltage		760
RWrn+39	Regenerative brake duty		760

Address <sup>*3</sup>	Description		Refer to page
	Upper 8 bits	Lower 8 bits	
RWwn+3A to RWwn+73	Reserved		—

Address <sup>*3</sup>	Description		Refer to page
	Upper 8 bits	Lower 8 bits	
RWrm+3A	Electric thermal relay function load factor		760
RWrm+3B	Output current peak value		760
RWrm+3C	Converter output voltage peak value		760
RWrm+3D	Input power		760
RWrm+3E	Output power		760
RWrm+3F	Input terminal status		760
RWrm+40	Output terminal status		760
RWrm+41	Load meter		760
RWrm+42	Motor excitation current		760
RWrm+43	Position pulse		760
RWrm+44	Cumulative energization time		760
RWrm+45	Reserved		—
RWrm+46	Orientation status		760
RWrm+47	Actual operation time		760
RWrm+48	Motor load factor		760
RWrm+49	Cumulative power		760
RWrm+4A	Position command (lower)		760
RWrm+4B	Position command (upper)		760
RWrm+4C	Current position (lower)		760
RWrm+4D	Current position (upper)		760
RWrm+4E	Droop pulse (lower)		760
RWrm+4F	Droop pulse (upper)		760
RWrm+50	Torque command		760
RWrm+51	Torque current command		760
RWrm+52	Motor output		760
RWrm+53	Feedback pulse monitor		760
RWrm+54	Torque monitor		760
RWrm+55	Reserved		—
RWrm+56	Trace status		760
RWrm+57	Reserved		—
RWrm+58	PLC function user monitor 1		760
RWrm+59	PLC function user monitor 2		760
RWrm+5A	PLC function user monitor 3		760
RWrm+5B	Station number (RS-485 terminals)		760
RWrm+5C	Station number (PU)		760
RWrm+5D	Station number (CC-Link)		760
RWrm+5E	Motor temperature		760
RWrm+5F to RWrm+61	Reserved		—
RWrm+62	Power saving effect		760
RWrm+63	Cumulative energy saving		760
RWrm+64	PID set point		760
RWrm+65	PID measured value		760
RWrm+66	PID deviation		760
RWrm+67 to RWrm+69	Reserved		—
RWrm+6A	Option input terminal status 1		760
RWrm+6B	Option input terminal status 2		760
RWrm+6C	Option output terminal status		760
RWrm+6D	Motor thermal load factor		760
RWrm+6E	Inverter thermal load factor		760
RWrm+6F	Reserved		—
RWrm+70	PTC thermistor value		760
RWrm+71	Reserved		—
RWrm+72			
RWrm+73	PID measured value 2		760



Address <sup>*3</sup>	Description		Refer to page
	Upper 8 bits	Lower 8 bits	
RWwn+74 to RWwn+7F	Reserved		—

Address <sup>*3</sup>	Description		Refer to page
	Upper 8 bits	Lower 8 bits	
RWrn+74 to RWrn+76	Reserved		—
RWrn+77	Cumulative pulse		760
RWrn+78	Cumulative pulse overflow times		760
RWrn+79	Cumulative pulse (control terminal option)		760
RWrn+7A	Cumulative pulse overflow times (control terminal option)		760
RWrn+7B to RWrn+7F	Reserved		—

\*1 When Pr.128 = "50, 51, 60, or 61", the register is valid.

\*2 Instructions will be processed in the order they are received. Thus, the read value of an instruction may differ at different timings if other writing requests are being made.

\*3 "n" indicates a value determined by the station number setting.

## 5.21.3 Details of the remote input and output signals

The following device numbers are for the station number 1.

For the station number 2 and later, the device numbers are different. (Refer to the manual for the CC-Link master module for the correspondence between device numbers and station numbers.)

### ◆ Output signals (from the master module to the inverter)

Output signals from the master module are as follows. (Input signals to the inverter)

Device No.	Signal	Description	
RY0	Forward rotation command	0: Stop command 1: Forward rotation start	<ul style="list-style-type: none"> <li>When "1" is set, a start command is input to the inverter. When "1" is set in RY0 and RY1, a stop command is input.</li> <li>The signals are fixed. They cannot be changed using parameters.</li> </ul>
RY1	Reverse rotation command	0: Stop command 1: Reverse rotation start	
RY2	High-speed operation command (terminal RH function)	<ul style="list-style-type: none"> <li>Functions assigned to terminals RH, RM, RL, JOG, RT, AU, CS, MRS, STOP and RES are activated.</li> <li>These signals are set in the initial setting. Using Pr.180 to Pr.189, input signals assigned to the device numbers can be changed. Some signals are not controllable via network depending on the settings of Pr.338 and Pr.339. For example, RYB reset (terminal RES function) cannot be controlled via network.</li> </ul>	
RY3	Middle-speed operation command (terminal RM function)		
RY4	Low-speed operation command (terminal RL function)		
RY5	Jog operation selection (terminal JOG function)		
RY6	Second function selection (terminal RT function)		
RY7	Current input selection (terminal AU function)		
RY8	Selection of automatic restart after instantaneous power failure (terminal CS function)		
RY9	Output stop (terminal MRS function)		
RYA	Start self-holding selection (terminal STOP function)		
RYB	Reset (terminal RES function)		
RY20	Monitor command	When "1" is set in the monitor command (R20), the monitored value is set in the remote register RWr26 to RWr2F, and "1" is set in the monitoring (RX20). While "1" is set in the monitor command (RY20), the monitored data is always updated.	
RY21	Frequency setting command (RAM)	When "1" is set in the frequency setting command (RY21), the set frequency (RWw0) is written to RAM of the inverter. While "1" is set, the set frequency (RWw0) is always applied. After the writing completes, "1" is set in the frequency setting completion (RX21).	
RY22	Frequency setting command (RAM, EEPROM)	When "1" is set in the frequency setting command (RY22), the set frequency (RWw0) is written to RAM and EEPROM of the inverter. After the writing completes, "1" is set in the frequency setting completion (RX22). To change the frequency consecutively, be sure to write data to the inverter RAM.	

Device No.	Signal	Description
RY23	Torque command / torque limit (RAM)	<p>When "1" is set in the torque command / torque limit (RY23), the set torque command / torque limit (RWw2) is written to RAM of the inverter. After the writing completes, "1" is set in the torque command / torque limit setting completion (RX23). The following value is written to RAM.</p> <ul style="list-style-type: none"> <li>• During torque control<sup>*1</sup>: Torque command value</li> <li>• During speed control / position control: Torque limit value</li> </ul>
RY24	Torque command / torque limit (RAM, EEPROM)	<p>When "1" is set in the torque command / torque limit (RY24), the set torque command / torque limit (RWw2) is written to RAM and EEPROM of the inverter. After the writing completes, "1" is set in the torque command / torque limit setting completion (RX24). The following value is written to RAM and EEPROM.</p> <ul style="list-style-type: none"> <li>• During torque control<sup>*1</sup>: Torque command value</li> <li>• During speed control / position control: Torque limit value</li> </ul> <p>To change the torque command or the torque limit consecutively, be sure to write data to the inverter RAM.</p>
RY25	Instruction code execution request	<p>When "1" is set in the instruction code execution request (RY25), processes corresponding to the instruction codes set to RWw10, 12, 14, 16, 18 and 1A are executed. "1" is set in the instruction code execution completed (RX25) after completion of instruction codes. When an instruction code execution error occurs, a value other than "0" is set in the reply code (RWw10, 12, 14, 16, 18, and 1A).</p>
RY3A	Error reset request flag	<p>When "1" is set in the error reset request flag (RY3A) at an inverter fault, the inverter is reset, then "0" is set in the error status flag (RX3A). Refer to <a href="#">page 669</a> for operation conditions of inverter reset.</p>

\*1 Torque control cannot be performed with a PM motor.

## ◆ Input signals (from the inverter to the master module)

Input signals to the master module are as follows. (Output signals from the inverter)

Device No.	Signal	Description
RX0	Forward running	0: Other than forward running (during stop or reverse rotation) 1: Forward running
RX1	Reverse running	0: Other than reverse running (during stop or forward rotation) 1: Reverse running
RX2	Running (terminal RUN function)	<ul style="list-style-type: none"> <li>• Functions assigned to terminals RUN, SU, OL, IPF, FU, ABC1 and ABC2 are activated.</li> <li>• These signals are set in the initial setting. Using <b>Pr.190 to Pr.196</b>, output signals assigned to the device numbers can be changed.</li> </ul>
RX3	Up to frequency (terminal SU function)	
RX4	Overload alarm (terminal OL function)	
RX5	Instantaneous power failure (terminal IPF function)	
RX6	Frequency detection (terminal FU function)	
RX7	Error (terminal ABC1 function)	
RX8	— (terminal ABC2 function)	<ul style="list-style-type: none"> <li>• Functions assigned to <b>Pr.313 to Pr.315</b> are activated.</li> <li>• No signal is assigned in the initial setting. Use <b>Pr.313 to Pr.315</b> to assign signals.</li> </ul>
RX10	— (DO0 function)	
RX11	— (DO1 function)	
RX12	— (DO2 function)	
RX20	Monitoring	After "1" is set in the monitor command (RY20), and the monitored value is set in the remote register RWr26 to RWr2F, "1" is set in this signal. When "0" is set in the monitor command (RY20), "0" is set in this signal.
RX21	Frequency setting completion (RAM)	After "1" is set in the frequency setting command (RY21) and the set frequency is written to the inverter RAM, "1" is set in this signal. When "0" is set in the frequency setting command (RY21), "0" is set in this signal.
RX22	Frequency setting completion (RAM, EEPROM)	After "1" is set in the frequency setting command (RY22) and the set frequency is written to the inverter RAM and EEPROM, "1" is set in this signal. When "0" is set in the frequency setting command (RY22), "0" is set in this signal.
RX23	Torque command / torque limit setting completion (RAM)	After "1" is set in the torque command / torque limit (RY23) and the torque command / torque limit value is written to the inverter RAM, "1" is set in this signal. When "0" is set in the torque command / torque limit (RY23), "0" is set in this signal.
RX24	Torque command / torque limit setting completion (RAM, EEPROM)	After "1" is set in the torque command / torque limit (RY24) and the torque command / torque limit value is written to the inverter RAM and EEPROM, "1" is set in this signal. When "0" is set in the torque command / torque limit (RY24), "0" is set in this signal.
RX25	Instruction code execution completed	After "1" is set in the instruction code execution request (RY25) and the processes corresponding to the instruction codes (RWW10, 12, 14, 16, 18 and 1A) are executed, "1" is set in this signal. When "0" is set in the instruction code execution request (RY25), "0" is set in this signal.
RX3A	Error status flag	When an inverter error occurs (protective function is activated), "1" is set in this signal.
RX3B	Remote station ready	When the inverter goes into the ready status upon completion of initial setting after power-on or hardware reset, "1" is set in this signal. When an inverter error occurs (protective function is activated), "0" is set in this signal. The signal is used as an interlock during the write to/read from the master module.

### 5.21.4 Details of the remote register

The following device numbers are for the station number 1.

For the station number 2 and later, the device numbers are different. (Refer to the manual for the CC-Link master module for the correspondence between device numbers and station numbers.)

## ◆ Remote register (from the master module to the inverter)

Device No.	Signal	Description
RWw0	Set frequency <sup>*1*2</sup>	<ul style="list-style-type: none"> <li>Specify the set frequency or rotations per minute (machine speed). At this time, whether to write to RAM or EEPROM is decided with the RY21 and RY22 settings. After setting the set frequency in this register, set "1" in RY21 or RY22 to write the frequency. After writing of frequency is completed, "1" is set in RX21 or RX22 in response to the input command.</li> <li>The setting range is 0 to 590.00 Hz (0.01 Hz increments). Write "59000" when setting 590.00 Hz.</li> </ul>
RWw2 <sup>*5</sup>	Torque command value	Specify the torque command value / torque limit value. Set <b>Pr.804 Torque command source selection</b> = "1, 3, 5, or 6" to activate this signal under Real sensorless vector control, Vector control, and PM sensorless vector control. The value is written to the inverter either by RY23 or RY24. <b>Pr.805 Torque command value (RAM)</b> and <b>Pr.806 Torque command value (RAM, EEPROM)</b> are updated as well. The setting range and the setting increment depend on the <b>Pr.804</b> setting. (Refer to <a href="#">page 762</a> .)
	Torque limit value	
RWw4	PID set point <sup>*3</sup>	Set the PID action set point. Setting range: 0 to 100.00%
RWw5	PID measured value <sup>*3</sup>	Set the PID measured value. Setting range: 0 to 100.00%
RWw6	PID deviation <sup>*3</sup>	Set the PID deviation. Setting range: -100.00 to 100.00%
RWw10, RWw12, RWw14, RWw16, RWw18, RWw1A	Link parameter extended setting / instruction code	Set an instruction code (refer to <a href="#">page 760</a> ) for an operation such as operation mode switching, parameter read/write, error reference, and error clear in the lower eight bits. The instructions are executed in the following order by setting "1" in RY25 after completing the register setting: RWw10, 12, 14, 16, 18, then 1A. After completing the execution up to RWw1A, "1" is set in RX25. Set HFFFF to disable an instruction by RWw10 to 1A. Set the link parameter extended setting in the upper 8 bits. Example) When reading <b>Pr.160</b> , instruction code is H0200.
RWw11, RWw13, RWw15, RWw17, RWw19, RWw1B	Write data	Set the data specified by the instruction code of RWw10, 12, 14, 16, 18 and 1A (when required). RWw10 and 11, 12 and 13, 14 and 15, 16 and 17, 18 and 19, and 1A and 1B correspond each other. Set "1" in RY25 after setting the instruction codes (RWw10, 12, 14, 16, 18 and 1A) and the corresponding register. Set "0" when the write data is not required.
RWw21	Fault history No. <sup>*4</sup>	Set the individual fault number of the fault history that you want to read. Fault records can be read back to the eighth latest fault. Last two digits: H00 (latest fault) to H07 (eighth latest fault) Set H08 to HFF to make the fault history No. to "0".
RWw26	Monitor code 1 <sup>*4</sup>	Set the monitor code to be monitored. By setting "1" in RY20 after setting, the specified monitor data is stored in RWr26 to RWr2F. If a monitor code out of the setting range is set, no item is monitored (the monitor value is fixed to 0). The monitor codes are the same as those of the RS-485 communication dedicated monitor. (Refer to <a href="#">page 446</a> .) When the remote registers RWw26 to 2F are used for monitoring, H01 (output frequency) and H05 (set frequency) always indicate the frequency regardless of the settings of <b>Pr.37</b> , <b>Pr.144</b> , and <b>Pr.811</b> .
RWw27	Monitor code 2 <sup>*4</sup>	
RWw28	Monitor code 3 <sup>*4</sup>	
RWw29	Monitor code 4 <sup>*4</sup>	
RWw2A	Monitor code 5 <sup>*4</sup>	
RWw2B	Monitor code 6 <sup>*4</sup>	
RWw2C	Monitor code 7 <sup>*4</sup>	
RWw2D	Monitor code 8 <sup>*4</sup>	
RWw2E	Monitor code 9 <sup>*4</sup>	
RWw2F	Monitor code 10 <sup>*4</sup>	

\*1 The rotation speed command or the machine speed command is selected according to the combination of **Pr.37**, **Pr.144**, and **Pr.811**. (Refer to [page 444](#).)

\*2 When **Pr.541 Frequency command sign selection** = "1", the set frequency is a signed value. When the setting value is negative, the command is the inverse from the start command. Setting range: -327.68 Hz to 327.67 Hz (-327.68 to 327.67), 0.01 Hz increments. (Refer to [page 699](#).)

\*3 When **Pr.128** = "50, 51, 60, or 61", the register is valid. If the data outside the range is set, the previous setting is retained. (Refer to [page 601](#).)

\*4 Write data is in hexadecimal, and only two digits are valid. (The upper two digits are ignored.)

\*5 The value in RWw2 is used as the torque limit value during speed control or position control, and as the torque command value during torque control. (Torque control cannot be performed with a PM motor.) To use the value as the torque limit value, set **Pr.810** = "2".

## ◆ Remote register (from the inverter to the master module)

Device No.	Signal	Description
RWr0	Reply code	When "1" is set in RY21 or RY22, the following reply codes are set for the frequency setting command. The setting value "0" is set normally, and a value other than "0" is set at an error. H0000: Normal H0001: Write mode fault H0003: Setting range fault
RWr2	Reply code	When "1" is set in RY23 or RY24, the following reply codes are set for the torque command / torque limit. The setting value "0" is set normally, and a value other than "0" is set at an error. H0000: Normal H0003: Setting range fault
RWr4, RWr5, RWr6	Reply code	When the PID command (RWw4 to RWw6) is set, the following reply code is set for the PID command. The setting value "0" is set normally, and a value other than "0" is set at an error. H0000: Normal H0003: Setting range fault
RWr10, RWr12, RWr14, RWr16, RWr18, RWr1A	Reply code	When "1" is set in RY25, the following reply codes corresponding to the instruction code RWw10, 12, 14, 16, 18, and 1A are set. The setting value "0" is set normally, and a value other than "0" is set at an error. H0000: Normal H0001: Write mode fault H0002: Parameter selection fault H0003: Setting range fault
RWr11, RWr13, RWr15, RWr17, RWr19, RWr1B	Read data	In a normal reply, a replay code for the instruction code is set.
RWr20	Error status	The setting value "0" is set during normal inverter operation, and the data code of the corresponding error is set at an error. (For the data codes or details of fault records, refer to <a href="#">page 776.</a> )
RWr21	Fault record (fault data)	The data code of fault history No. specified by RWw21 is stored in the lower 8 bits. Lower 8 bits of RWw21 will be reverted back to the upper 8 bits.
RWr22	Fault record (output frequency)	The output frequency of the fault history No. specified in RWw21 is stored.
RWr23	Fault record (output current)	The output current of the fault history No. specified in RWw21 is always stored.
RWr24	Fault record (output voltage)	The output voltage of the fault history No. specified in RWw21 is always stored.
RWr25	Fault record (energization time)	The energization time of the fault history No. specified in RWw21 is always stored.
RWr26	First monitor value	When "1" is set in RY20, the monitor value specified to the corresponding monitor code (RWw26 to RWw2F) is stored. The output frequency, output current, and output voltage monitors are held at an inverter failure.
RWr27	Second monitor value	
RWr28	Third monitor value	
RWr29	Fourth monitor value	
RWr2A	Fifth monitor value	
RWr2B	Sixth monitor value	
RWr2C	Seventh monitor value	
RWr2D	Eighth monitor value	
RWr2E	Ninth monitor value	
RWr2F	Tenth monitor value	
RWr30 to RWr7F	Monitor value	Fixed monitored data are saved regardless of the RY20 setting. The output frequency, output current, and output voltage monitors are held at an inverter failure.

## ◆ Instruction code

Set instruction codes using the remote register (RWw). (Refer to [page 759.](#))



Item	Read/write	Instruction code	Data description
Parameter clear All parameter clear	Write	HFC	All parameters return to initial values. Whether to clear communication parameters or not can be selected according to the data. <ul style="list-style-type: none"> <li>Parameter clear H9696: Communication parameters are cleared. H5A5A<sup>*5</sup>: Communication parameters are not cleared.</li> <li>All parameter clear H9966: Communication parameters are cleared. H55AA<sup>*5</sup>: Communication parameters are not cleared.</li> </ul> For details on whether or not to clear parameters, refer to <a href="#">page 864</a> . When clear is performed with H9696 or H9966, communication related parameter settings also return to the initial values. When resuming the operation, set the parameters again. Performing a clear will clear the instruction code HEC, HF3, and HFF settings.
Inverter reset	Write	HFD	H9696: Resets the inverter.
Second parameter changing <sup>*6</sup>	Read	H6C	Read or write of bias and gain parameters (instruction codes H5E to H61 and HDE to HE1 with the link parameter extended setting = "1", H11 to H23 and H91 to HA3 with the link parameter extended setting = "9").
	Write	HEC	H00: Frequency <sup>*7</sup> H01: Parameter-set analog value H02: Analog value input from terminal

- \*1 When "100" is set in **Pr.52 Operation panel main monitor selection**, set frequency is monitored during a stop and output frequency is monitored during running.
- \*2 When position control is selected, the number of pulses is monitored when **Pr.430** ≠ "9999".
- \*3 Write data is in hexadecimal, and only two digits are valid. (The upper two digits are ignored.)
- \*4 Setting from the remote register (RWw0) is also available.
- \*5 Turning OFF the power supply while clearing parameters with H5A5A or H55AA returns the communication parameter settings to the initial settings.
- \*6 Reading or writing is available when the link parameter extended setting = "1 or 9".
- \*7 The gain frequency can be also written using **Pr.125** (instruction code: H99) or **Pr.126** (instruction code: H9A).

**NOTE**

- When a 32-bit parameter setting or monitored value is read and the read value exceeds HFFFF, the reply data will be HFFFF.

## ◆ Torque command / torque limit through CC-Link IE Field Network communication

- Torque commands can be given or the torque can be limited via CC-Link IE Field Network under Real sensorless vector control, Vector control, or PM sensorless vector control. The value is used to limit the torque during speed control or position control, and to give a torque command during torque control. To limit the torque, set **Pr.810** = "2". The torque command / torque limit setting method can be selected using **Pr.804 Torque command source selection**. (Torque control cannot be performed with a PM motor.)
- For setting the torque limit parameters, refer to [page 245](#), and for setting the torque command parameters, refer to [page 283](#).
- Set the torque command value or the torque limit value in RWw2. The RWw2 function is switched according to the **Pr.804** and **Pr.810** settings and the control mode.

Pr.804 setting	Pr.810 setting	RWw2 function	
		Speed control / position control	Torque control
1, 3, 5, 6	2	Torque limit	Torque command
	0, 1	RWw2 disabled	Torque command
0, 4	—	RWw2 disabled	RWw2 disabled

- Relationship between the **Pr.804** setting, the setting range, and the actual torque command / torque limit (when setting is made from CC-Link IE Field Network communication)

Pr.804 setting	Setting range	Actual torque command	Actual torque limit
1, 3	600 to 1400 (1% increments) <sup>*1</sup>	-400 to 400%	0 to 400%
5, 6	-32768 to 32767 (two's complement) <sup>*1</sup>	-327.68 to 327.67%	0 to 327.67%

\*1 The torque limit setting is defined as an absolute value.



- Torque command / torque limit setting method

Setting method	Setting procedure
Writing in RWw2	1. Set the torque command / torque limit value in RWw2. 2. Set "1" in RY23 (or RY24).
Writing in Pr.805 or Pr.806	1. Set link parameter extended setting = H08 for RWw10 (12, 14, 16, 18, 1A). 2. Set H85 or H86 as the instruction code. 3. Set the torque command / torque limit value in RWw11 (13, 15, 17, 19, 1B). 4. Set "1" in RY25.

## 5.21.5 Programming examples

The following explains the programming examples for controlling the inverter with sequence programs.

Item	Program example	Refer to page
Reading the inverter status	Reading the inverter status from the buffer memory of the master station	765
Setting the operation mode	Selecting the Network operation mode	765
Setting the operation commands	Commanding the forward rotation and middle speed signals	766
Setting the monitoring function	Monitoring the output frequency	766
Reading a parameter value	Reading the value of <b>Pr.7 Acceleration time</b>	767
Writing a parameter value	Setting "3.0 s" in <b>Pr.7 Acceleration time</b>	767
Setting the set frequency (set speed)	Setting to 50.00 Hz	768
Reading the fault records	Reading the inverter faults	769
Inverter reset	Resetting the inverter when an inverter error occurs	769

- System configuration for programming example

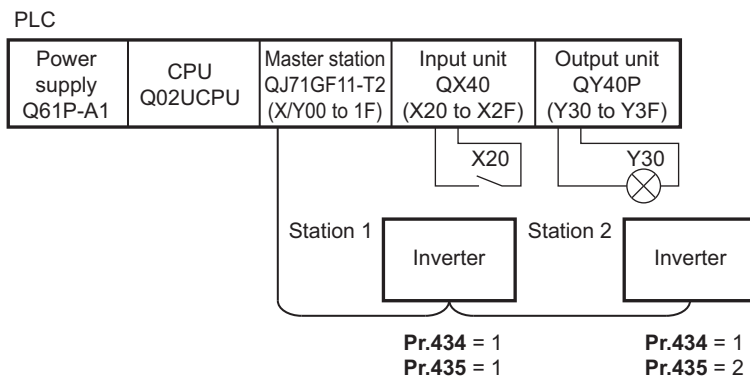

- In the programming example, network parameters of the master station are set as follows. (Network parameters (module 1))

Item	Setting condition
Network type	CC-Link IE Field (master station)
Start I/O	0000
Network No.	1
Total number of (slave) stations	2
Mode	Online (standard mode)
Network configuration	Refer to the following.
Refresh parameter	Refer to the following.



- Network configuration (assignment method: start/end)

Item	Setting condition	
	Module 1	Module 2
Station number	1	2
Station type	Intelligent device station	Intelligent device station
RX/RX setting	Start	0000
	End	003F
RWw/RWr setting	Start	0000
	End	007F
Reserved station / error invalid station	No setting	No setting

- Refresh parameters (assignment method: start/end)

Link side			Master side		
Device name	Start	End	Device name	Start	End
SB	0000	01FF	SB	0000	01FF
SW	0000	01FF	SW	0000	01FF
RX	0000	007F	X	1000	107F
RY	0000	007F	Y	1000	107F
RWr	0000	00FF	W	000000	0000FF
RWw	0000	00FF	W	000100	0001FF

- Remote I/O (RX and RY) transmitted between the programmable controller CPU and intelligent device stations

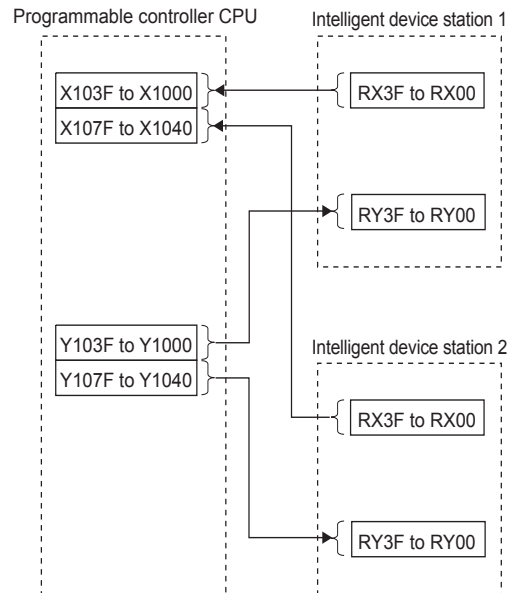

- Remote registers (RWw and RWr) transmitted between the programmable controller CPU and the intelligent device stations

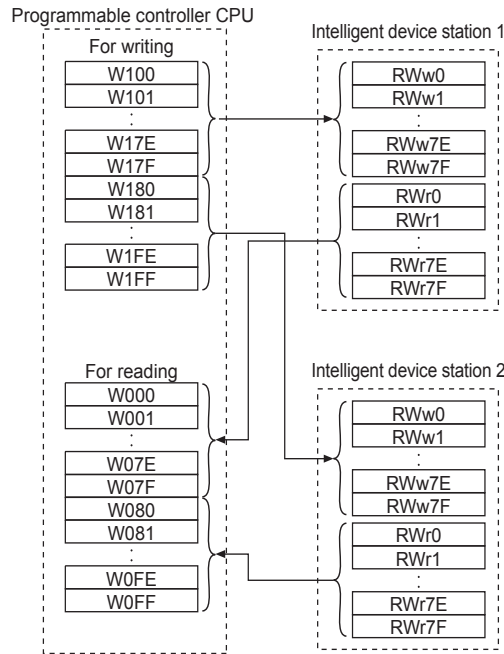

### ◆ Programming example for reading the inverter status

The following program turns ON the signal Y00 of the output unit when the station 1 inverter starts running.

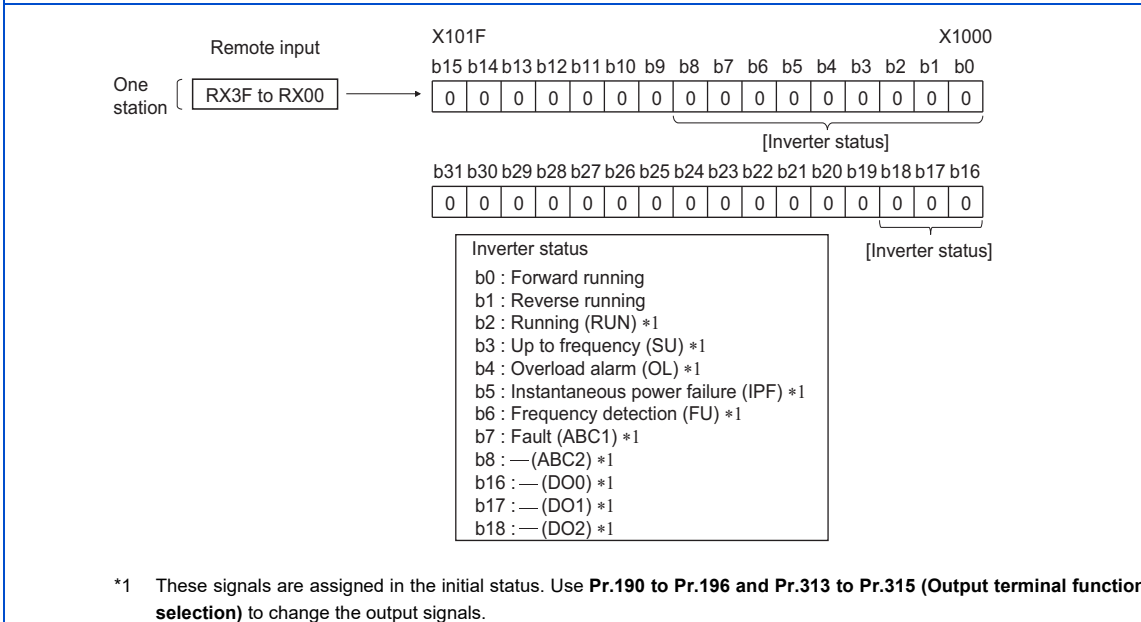
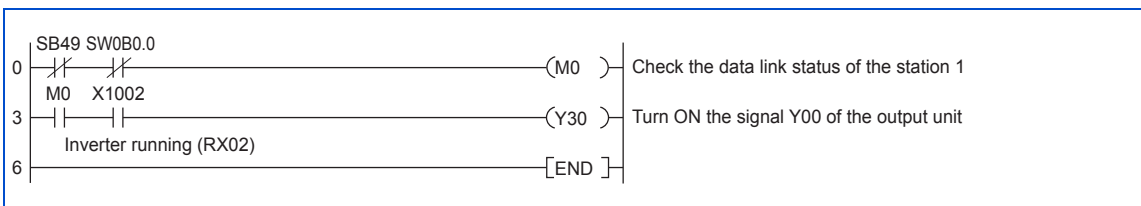

### ◆ Programming example for setting the operation mode

The following explains a program to write various data to the inverter.

The following program changes the operation mode of the station 1 inverter to network operation.

- Operation mode write code: HFB (hexadecimal)
- Network operation set data: H0000 (hexadecimal) (Refer to [page 760.](#))



Example) The output frequency of 60 Hz is indicated as "H1770 (6000)".

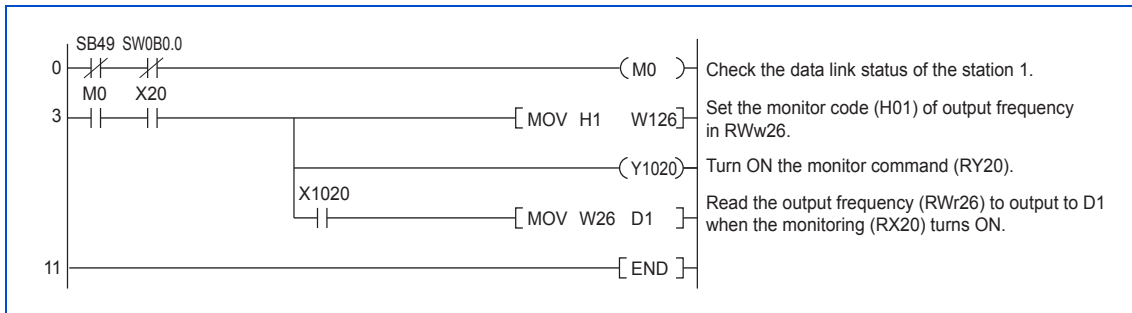

## ◆ Programming example for the parameter reading

The following program reads **Pr.7 Acceleration time** of the station 1 inverter to output to D1.

- **Pr.7 Acceleration time** reading instruction code: H07 (hexadecimal)
- Refer to [page 864](#) for details on the parameter instruction code.
- The reply code (RWr10) to the instruction code execution is set in D2. (Refer to [page 760](#) for the reply code (RWr10).)

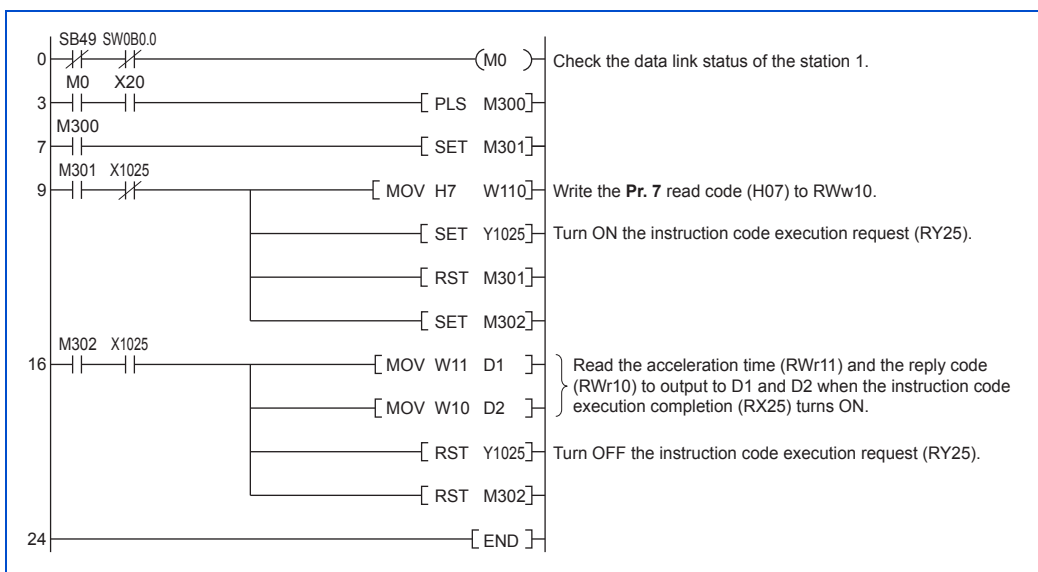

### NOTE

- For the parameter assigned the number of 100 or higher, change the link parameter extended setting (set it to the one other than H00). Refer to [page 864](#) for the settings.

## ◆ Programming example for the parameter writing

The following program changes the setting value in **Pr.7 Acceleration time** of the station 1 inverter to 3.0 seconds.

- Acceleration time writing instruction code: H87 (hexadecimal)
- Acceleration time setting data: K30 (decimal)

For details on instruction codes of each parameter, refer to the list of parameters (function codes) and instruction codes under different control modes (on [page 864](#)).

The reply code (RWr10) to the instruction code execution is set in D2. (Refer to [page 760](#) for the reply code (RWr10).)

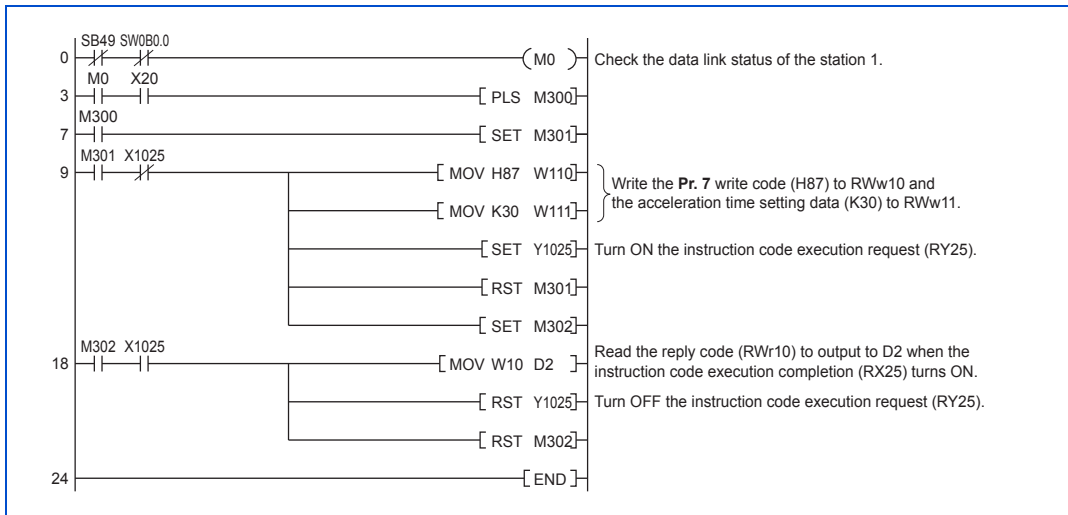

**NOTE**

- For the parameter assigned the number of 100 or higher, change the link parameter extended setting (set it to the one other than H00). Refer to [page 864](#) for the settings.
- For other functions, refer to the instruction codes (refer to [page 760](#)).

**◆ Programming example for setting the running frequency**

The following program changes the running frequency of the station 1 inverter to 50.00 Hz.

- Set frequency: K5000 (decimal)
- The reply code (RWr10) to the instruction code execution is set in D2. (Refer to [page 760](#) for the reply code (RWr0).)

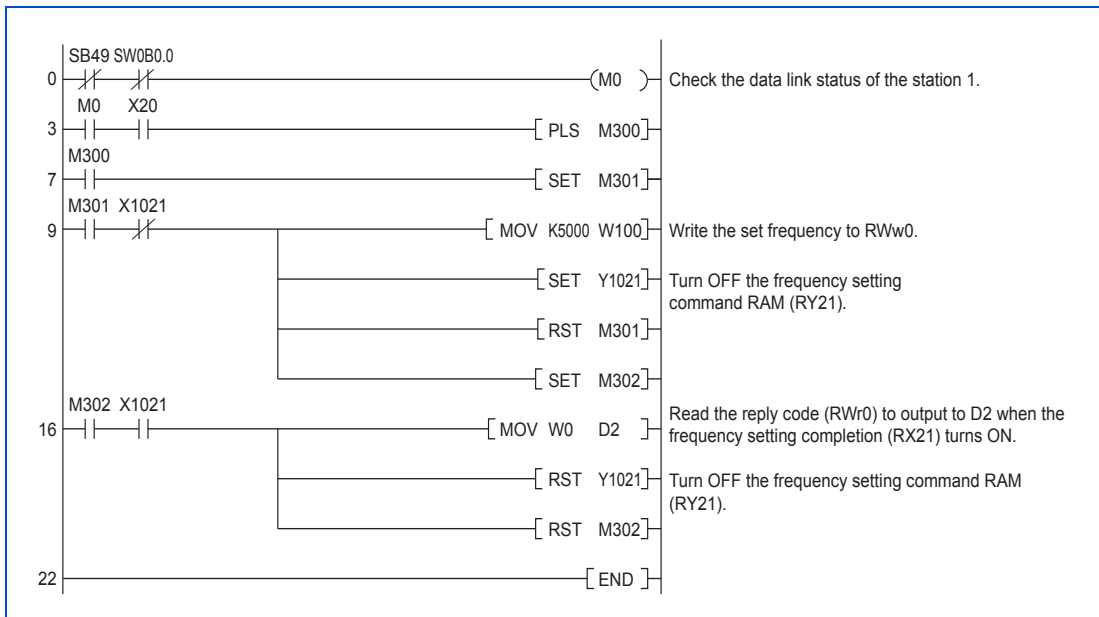

**NOTE**

- To change the set frequency continuously from a programmable controller, check that the frequency setting complete (for example, X1021) turns ON, and the reply code from the intelligent register is H0000. Then change the setting data (for example, W100) continuously.
- To write the set frequency to the EEPROM, change the following points in the program shown above.
  - Frequency setting command (from Y1021 to Y1022)
  - Frequency setting completion (from X1021 to X1022)

<Timing chart for writing to the RAM>

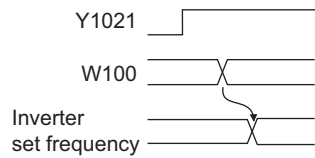

<Timing chart for writing to the EEPROM>

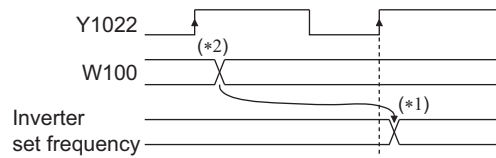

Apply to the inverter when the command Y1022 turns ON.

\*1 To the EEPROM, a writing is performed only once after the command Y1022 turns ON.

\*2 If the set data is changed at the command Y1022 ON, the change is not applied to the inverter.

## ◆ Programming example for the fault record reading

The following program reads the fault records of the station 1 inverter to output to D1.

- Fault history No. 1 and 2 reading instruction code: H74 (hexadecimal)

For the error code, refer to [page 776](#).

The reply code (RWr10) to the instruction code execution is set in D2. (Refer to [page 760](#) for the reply code (RWr10).)

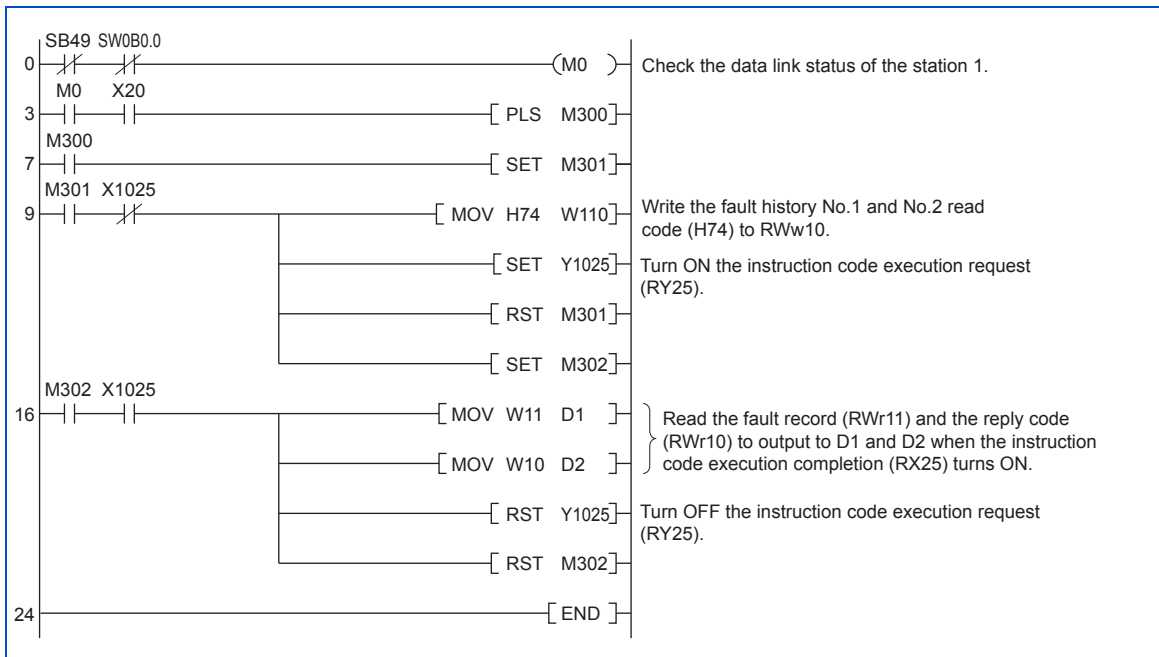

## ◆ Programming example for resetting the inverter at an inverter fault

The following program resets the station 1 inverter at an inverter fault.

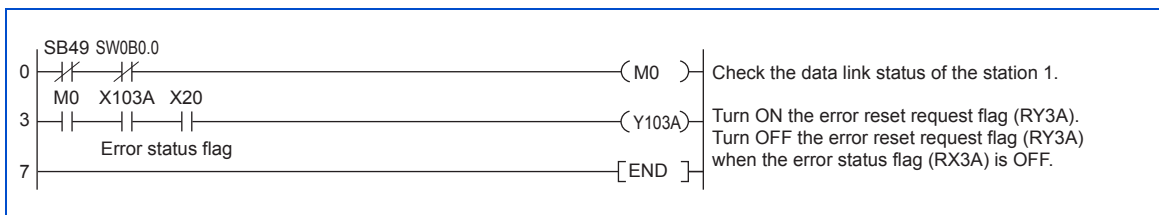

### NOTE

- The inverter reset with the flag RY3A shown above is enabled at an inverter fault only.
- When **Pr.349 Communication reset selection/Ready bit status selection** = "0 or 100", inverter reset is available independently of the operation mode.
- When using the instruction code execution request (RY25) with the instruction code (HFD) and data (H9696) to reset the inverter, set a value other than "0" in **Pr.340 Communication startup mode selection** or change the operation mode to the Network operation mode. (For the program example, refer to [page 765](#).)

## 5.21.6 Instructions

### ◆ Programming instructions

- Since the buffer memory data of the master station is kept transferred (refreshed) to/from the inverters, the TO instruction need not be executed every scan in response to data write or read requests. (The execution of the TO instruction every scan does not pose any problem.)
- If the FROM/TO instruction is executed frequently, data may not be written reliably. When transferring data between the inverter and sequence program via the buffer memory, perform the handshake to confirm that data has been written without error.

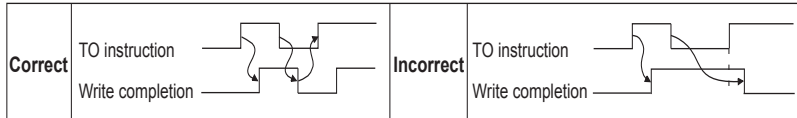

### ◆ Operating and handling instructions

- The commands only from the programmable controller can be accepted during CC-Link IE Field Network communication. The run command from external and parameter unit is ignored.
- If multiple inverters have the same station number, the communication cannot be performed properly.
- The inverter protective function (E.OP1) is activated if data communication stops for more than the time set in **Pr.500 Communication error execution waiting time** due to a programmable controller fault, an open Ethernet cable etc. during CC-Link IE Field Network operation.
- If the programmable controller (master station) is reset during CC-Link IE Field Network operation or if the programmable controller is powered off, data communication stops and the inverter protective function (E.OP1) is activated. To reset the programmable controller (master station), switch the operation mode to the External operation once, then reset the programmable controller.
- When **Pr.340** = "0 (initial value)", any inverter whose main power is restored is reset to return to the External operation mode. To resume the Network operation, therefore, set the operation mode to the Network operation using the sequence program. Set a value other than "0" in **Pr.340** to start in the Network operation mode after inverter reset.

## 5.21.7 Troubleshooting

Description	Point to be checked
Operation mode does not switch to the Network operation mode.	Check for looseness of the connector between the CC-Link IE Field Network communication circuit board and the inverter's control circuit board. Check that the Ethernet cable is installed correctly. (Check for contact fault, break in the cable, etc.)
	Check that <b>Pr.434 Network number (CC-Link IE)</b> and <b>Pr.435 Station number (CC-Link IE)</b> are correctly set. (Check that their settings match with the program, that the network number is set within the range, that no overlapping stations exist, and that the station number is set within the range.)
	Check that the inverter is in the External operation mode.
	Check that the operation mode switching program is running.
	Check that the operation mode switching program has been written correctly.
Inverter does not start in the Network operation mode.	Check that the inverter starting program is running.
	Check that the inverter starting program has been written correctly.
	Check that <b>Pr.338 Communication operation command source</b> is not set to External.

# CHAPTER 6 PROTECTIVE FUNCTIONS

- 6.1 Inverter fault and alarm indications .....772
- 6.2 Reset method for the protective functions .....773
- 6.3 Check and clear of the fault history .....774
- 6.4 List of fault displays .....776
- 6.5 Causes and corrective actions.....779
- 6.6 Check first when you have a trouble.....800



# 6 PROTECTIVE FUNCTIONS

This chapter explains the "PROTECTIVE FUNCTIONS" that operate in this product.

Always read the instructions before use.

## 6.1 Inverter fault and alarm indications

- When the inverter detects a fault, depending on the nature of the fault, the operation panel displays an error message or warning, or a protective function is activated to shut off the inverter output.
- When any fault occurs, take an appropriate corrective action, then reset the inverter, and resume the operation. Restarting the operation without a reset may break or damage the inverter.
- When a protective function is activated, note the following points.

Item	Description
Fault output signal	Opening the magnetic contactor (MC) provided on the input side of the inverter at a fault occurrence shuts off the control power to the inverter, therefore, the fault output will not be retained.
Fault or alarm indication	When a protective function is activated, the operation panel displays a fault indication.
Operation restart method	While a protective function is activated, the inverter output is kept shutoff. Reset the inverter to restart the operation.

- Inverter fault or alarm indications are categorized as follows.

Displayed item	Description
Error message	A message regarding operational fault and setting fault by the operation panel and the parameter unit. The inverter output is not shut off.
Warning	The inverter output is not shut off even when a warning is displayed. However, failure to take appropriate measures will lead to a fault.
Alarm	The inverter output is not shut off. An Alarm (LF) signal can also be output with a parameter setting.
Fault	When a protective function is activated, the inverter output is shut off and a Fault (ALM) signal is output.

### NOTE

- The last eight faults can be displayed on the operation panel. (Fault history) (For the operation, refer to [page 774](#).)

## 6.2 Reset method for the protective functions

Reset the inverter by performing any of the following operations. Note that the accumulated heat value of the electronic thermal relay function and the number of retries are cleared (erased) by resetting the inverter.

The inverter recovers about 1 second after the reset is released.

- On the operation panel, press  to reset the inverter. (This operation is valid only when a protective function for a fault is activated. (Refer to [page 785](#) of the Instruction Manual for faults.))

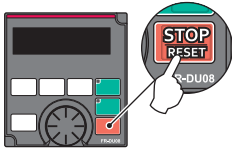

- Switch the power OFF once, then switch it ON again.

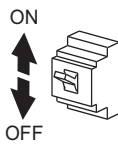

- Turn ON the Reset (RES) signal for 0.1 second or more. (If the RES signal is kept ON, "Err" appears (blinks) to indicate that the inverter is in a reset status.)

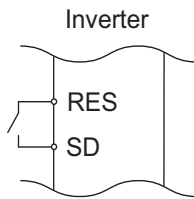

### NOTE

- OFF status of the start signal must be confirmed before resetting the inverter fault. Resetting an inverter fault with the start signal ON restarts the motor suddenly.

# 6.3 Check and clear of the fault history

The operation panel stores the fault indications which appear when a protective function is activated to display the fault record for the past 8 faults (fault history).

## ◆ Check for the fault history

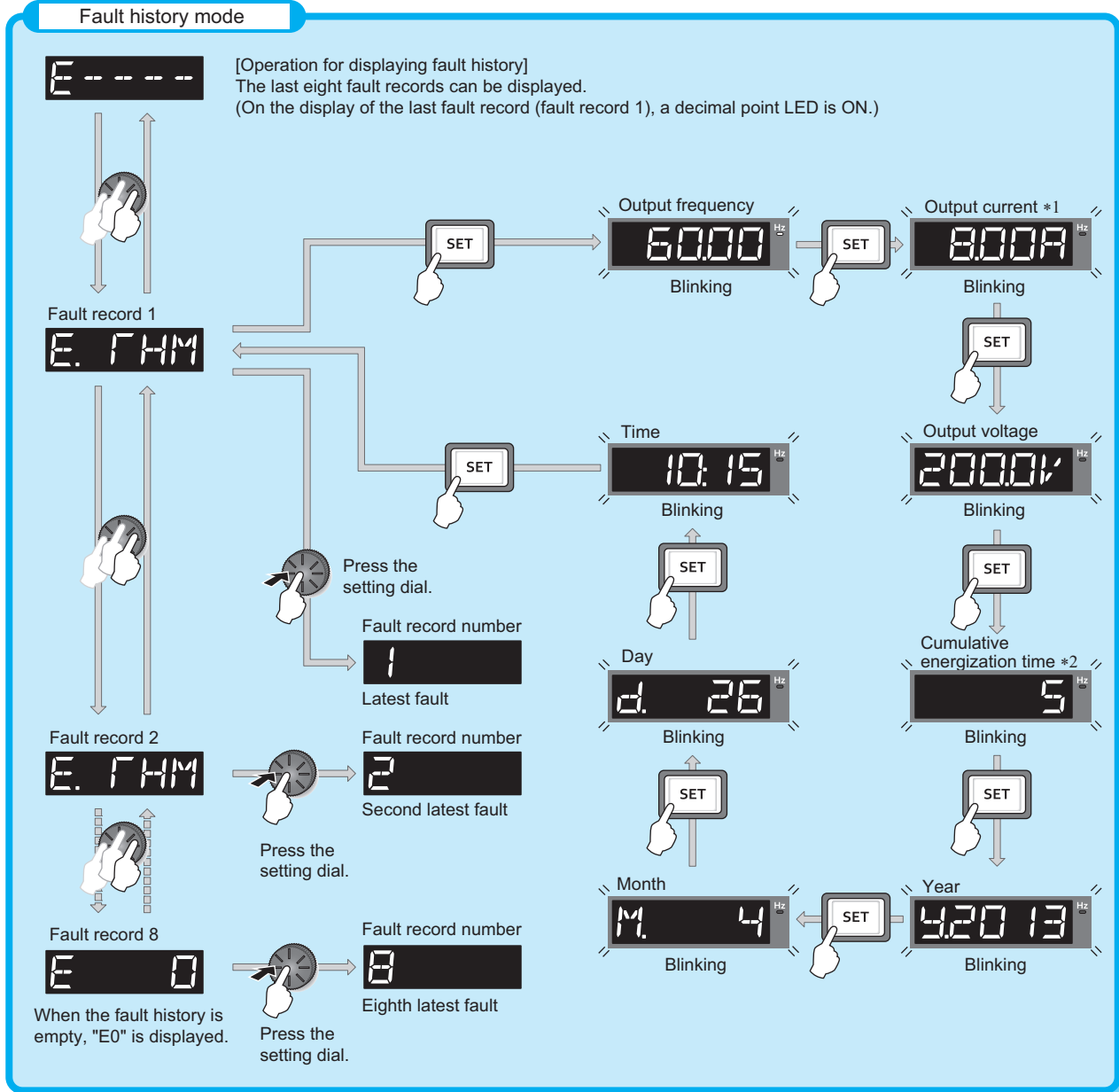
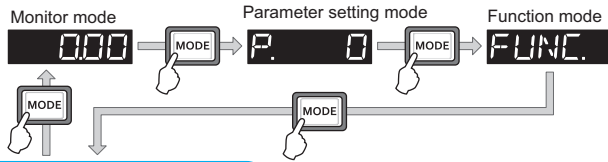









\*1 When an overcurrent trip occurs by an instantaneous overcurrent, the monitored current value saved in the fault history may be lower than the actual current that has flowed.  
 \*2 The cumulative energization time and actual operation time are accumulated from 0 to 65535 hours, then cleared, and accumulated again from 0.

## ◆ Fault history clearing procedure

### Point

- Set **Err.CL Fault history clear** = "1" to clear the fault history.

### Operating procedure

- 1.** Turning ON the power of the inverter  
The operation panel is in the monitor mode.
- 2.** Selecting the parameter setting mode  
Press  to choose the parameter setting mode. (The parameter number read previously appears.)
- 3.** Selecting the parameter number  
Turn  until "Err.CL" (Fault history clear) appears. Press  to read the present set value. "0" (initial value) appears.
- 4.** Fault history clear  
Turn  to change the set value to "1". Press  to start clearing.  
"1" and "Err.CL" are displayed alternately after parameters are cleared.
  - Turn  to read another parameter.
  - Press  to show the setting again.
  - Press  twice to show the next parameter.

## 6.4 List of fault displays

If the displayed message does not correspond to any of the following or if you have any other problem, contact your sales representative.

### ◆ Error message

- A message regarding operational fault and setting fault by the operation panel and the parameter unit is displayed. The inverter output is not shut off.

Operation panel indication	Name	Refer to page
HOLD	Operation panel lock	779
LOCd	Password locked	779
Er 1 to Er 4 Er 8	Parameter write error	779, 780
rE 1 to rE 8	Copy operation fault	780, 781
Err.	Error	781

### ◆ Warning

- The inverter output is not shut off even when a warning is displayed. However, failure to take appropriate measures will lead to a fault.

Operation panel indication	Name	Refer to page
OL	Stall prevention (overcurrent)	782
oL	Stall prevention (overvoltage)	782
Rb	Regenerative brake pre-alarm	782
TH	Electronic thermal relay function pre-alarm	783
PS	PU stop	783
SL	Speed limit indication	783
CP	Parameter copy	783
SA	Safety stop	783
Mf 1 to Mf 3	Maintenance signal output	784
UF	USB host error	784
HP 1	Home position return setting error	784
HP 2	Home position return uncompleted	784
HP 3	Home position return parameter setting error	784

Operation panel indication	Name	Refer to page
CF	Continuous operation during communication fault	784
LdF	Load fault warning	784

### ◆ Alarm

- The inverter output is not shut off. An Alarm (LF) signal can also be output with a parameter setting.

Operation panel indication	Name	Refer to page
FN	Fan alarm	785
FN2	Internal fan alarm	785

### ◆ Fault

- When a protective function is activated, the inverter output is shut off and a Fault (ALM) signal is output.
- The data code is used for checking the fault detail via communication or with **Pr.997 Fault initiation**.

#### ■ Data code 16 to 199

Operation panel indication	Name	Data code	Refer to page
E. OC 1	Overcurrent trip during acceleration	16 (H10)	785
E. OC 2	Overcurrent trip during constant speed	17 (H11)	786
E. OC 3	Overcurrent trip during deceleration or stop	18 (H12)	786
E. OV 1	Regenerative overvoltage trip during acceleration	32 (H20)	787
E. OV 2	Regenerative overvoltage trip during constant speed	33 (H21)	787
E. OV 3	Regenerative overvoltage trip during deceleration or	34 (H22)	787
E. THF	Inverter overload trip (electronic thermal relay)	48 (H30)	787
E. THM	Motor overload trip (electronic thermal relay)	49 (H31)	788
E. FIN	Heat sink overheat	64 (H40)	788
E. IPF	Instantaneous power failure	80 (H50)	788
E. UVF	Undervoltage	81 (H51)	789
E. ILF	Input phase loss	82 (H52)	789
E. OLF	Stall prevention stop	96 (H60)	789
E. SOF	Loss of synchronism detection	97 (H61)	790
E. LUP	Upper limit fault detection	98 (H62)	790
E. LDN	Lower limit fault detection	99 (H63)	790

Operation panel indication	Name	Data code	Refer to page
E. bE	Brake transistor alarm detection	112 (H70)	790
E. GF	Output side earth (ground) fault overcurrent	128 (H80)	790
E. LF	Output phase loss	129 (H81)	791
E. OHT	External thermal relay operation	144 (H90)	791
E. PTC	PTC thermistor operation	145 (H91)	791
E. OPI	Option fault	160 (HA0)	791
E. OP1	Communication option fault	161 (HA1)	792
E. OP2		162 (HA2)	
E. OP3		163 (HA3)	
E. 16		164 (HA4)	
E. 17	165 (HA5)	792	
E. 18	User definition error by the PLC function		166 (HA6)
E. 19	167 (HA7)		
E. 20	168 (HA8)		
E. PE	Parameter storage device fault (control circuit board)	176 (HB0)	792
E. PUE	PU disconnection	177 (HB1)	792
E. REF	Retry count excess	178 (HB2)	793
E. PE2	Parameter storage device fault (main circuit board)	179 (HB3)	793
E. CPU	CPU fault	192 (HC0)	793
E. CFE	Operation panel power supply short circuit/RS-485	193 (HC1)	793
E. P24	24 VDC power fault	194 (HC2)	793
E. Cd0	Abnormal output current detection	196 (HC4)	794
E. IOH	Inrush current limit circuit fault	197 (HC5)	794
E. SER	Communication fault (inverter)	198 (HC6)	794
E. AIE	Analog input fault	199 (HC7)	794

#### ■ Data code 200 or more

Operation panel indication	Name	Data code	Refer to page
E. USB	USB communication fault	200 (HC8)	794
E. SAF	Safety circuit fault	201 (HC9)	795
E. Pbf	Internal circuit fault	202 (HCA)	795
E. 13		253 (HFD)	

Operation panel indication	Name	Data code	Refer to page
E. OS	Overspeed occurrence	208 (HD0)	795
E. OSd	Speed deviation excess detection	209 (HD1)	795
E. ECF	Signal loss detection	210 (HD2)	796
E. Od	Excessive position fault	211 (HD3)	796
E. ECA	Orientation encoder no-signal	212 (HD4)	796
E. Mb1	Brake sequence fault	213 (HD5)	797
E. Mb2		214 (HD6)	
E. Mb3		215 (HD7)	
E. Mb4		216 (HD8)	
E. Mb5		217 (HD9)	
E. Mb6		218 (HDA)	
E. Mb7		219 (HDB)	
E. EP	Encoder phase fault	220 (HDC)	797
E. MP	Magnetic pole position unknown	222 (HDE)	797
E. EF	External fault during output operation	224 (HE0)	797
E. IAH	Abnormal internal temperature	225 (HE1)	797
E. LCI	4 mA input fault	228 (HE4)	797
E. PCH	Pre-charge fault	229 (HE5)	798
E. PId	PID signal fault	230 (HE6)	798
E. 1	Option fault	241 (HF1)	798
E. 2		242 (HF2)	
E. 3		243 (HF3)	
E. 5	CPU fault	245 (HF5)	793
E. 6		246 (HF6)	
E. 7		247 (HF7)	
E. 11	Opposite rotation deceleration fault	251 (HFB)	799

#### ◆ Others

- The fault history and the operation status of the inverter are displayed. It is not a fault indication.

Operation panel indication	Name	Refer to page
E. - - - -	Fault history	774
E. 0	No fault history	799



Operation panel indication	Name	Refer to page
EV	24 V external power supply operation	799
Rd	Backup in progress	799
WR	Restoration in progress	799

If faults other than the above appear, contact your sales representative.

## 6.5 Causes and corrective actions

### ◆ Error message

A message regarding operational troubles is displayed. Output is not shut off.

Operation panel indication	HOLD	HOLD
Name	Operation panel lock	
Description	Operation lock is set. Operation other than  is invalid. (Refer to <a href="#">page 341</a> .)	
Check point	-----	
Corrective action	Press  for 2 seconds to release the lock.	

Operation panel indication	LOCD	LOCD
Name	Password locked	
Description	Password function is active. Display and setting of parameters are restricted.	
Check point	-----	
Corrective action	Enter the password in <b>Pr.297 Password lock/unlock</b> to unlock the password function before operating. (Refer to <a href="#">page 348</a> .)	

Operation panel indication	Er1	Er 1
Name	Write disable error	
Description	<ul style="list-style-type: none"> <li>Parameter setting was attempted while <b>Pr.77 Parameter write selection</b> is set to disable parameter write.</li> <li>Overlapping range has been set for the frequency jump.</li> <li>Overlapping range has been set for the adjustable 5 points V/F.</li> <li>The PU and inverter cannot make normal communication.</li> <li>IPM parameter initialization was attempted while <b>Pr.72 PWM frequency selection</b> = "25".</li> </ul>	
Check point	<ul style="list-style-type: none"> <li>Check the <b>Pr.77</b> setting. (Refer to <a href="#">page 345</a>.)</li> <li>Check the settings of <b>Pr.31 to Pr.36 (frequency jump)</b>. (Refer to <a href="#">page 429</a>.)</li> <li>Check the settings of <b>Pr.100 to Pr.109 (adjustable 5 points V/F)</b>. (Refer to <a href="#">page 713</a>.)</li> <li>Check the connection of PU and the inverter.</li> <li>Check the <b>Pr.72</b> setting. A sine wave filter cannot be used under PM sensorless vector control.</li> </ul>	

Operation panel indication	Er2	Er 2
Name	Write error during operation	
Description	Parameter write was attempted while <b>Pr.77 Parameter write selection</b> = "0".	
Check point	<ul style="list-style-type: none"> <li>Check that the inverter is stopped.</li> </ul>	
Corrective action	<ul style="list-style-type: none"> <li>After stopping the operation, make parameter setting.</li> <li>When setting <b>Pr.77</b> = "2", parameter write is enabled during operation. (Refer to <a href="#">page 345</a>.)</li> </ul>	

Operation panel indication	Er3	Er 3
Name	Calibration error	
Description	Analog input bias and gain calibration values have been set too close.	
Check point	Check the settings of the <b>calibration parameters C3, C4, C6, and C7</b> (calibration functions). (Refer to <a href="#">page 505</a> .)	

Operation panel indication	Er4	Er 4
Name	Mode designation error	
Description	<ul style="list-style-type: none"> <li>Parameter setting was attempted in the External or NET operation mode while <b>Pr.77 Parameter write selection</b> = "1".</li> <li>Parameter write was attempted when the command source is not at the operation panel (FR-DU08).</li> </ul>	
Check point	<ul style="list-style-type: none"> <li>Check that the operation mode is the PU operation mode.</li> <li>Check that the <b>Pr.551 PU mode operation command source selection</b> setting is correct.</li> </ul>	
Corrective action	<ul style="list-style-type: none"> <li>After setting the operation mode to the "PU operation mode", make parameter setting. (Refer to <a href="#">page 389</a>.)</li> <li>When <b>Pr.77</b> = "2", parameter write is enabled regardless of the operation mode. (Refer to <a href="#">page 345</a>.)</li> <li>Set <b>Pr.551</b> = "2". (Refer to <a href="#">page 400</a>.)</li> </ul>	



<b>Operation panel indication</b>	<b>Er8</b>	<b>Er8</b>
<b>Name</b>	USB memory device operation error	
<b>Description</b>	<ul style="list-style-type: none"> <li>• An operation command was given during the USB memory device operation.</li> <li>• A copy operation (writing) was performed while the PLC function was in the RUN state.</li> <li>• A copy operation was attempted for a password locked project.</li> </ul>	
<b>Check point</b>	<ul style="list-style-type: none"> <li>• Check if the USB memory device is operating.</li> <li>• Check if the PLC function is in the RUN state.</li> <li>• Check if the project data is locked with a password.</li> </ul>	
<b>Corrective action</b>	<ul style="list-style-type: none"> <li>• Perform the operation after the USB memory device operation is completed.</li> <li>• Stop the PLC function. (Refer to <a href="#">page 646</a> and the PLC function programming manual.)</li> <li>• Unlock the password of the project data using FR Configurator2. (Refer to the Instruction Manuals of FR Configurator2 and GX Works2.)</li> </ul>	

<b>Operation panel indication</b>	<b>rE1</b>	<b>rE1</b>
<b>Name</b>	Parameter read error	
<b>Description</b>	<ul style="list-style-type: none"> <li>• A failure has occurred at the operation panel side EEPROM while reading the copied parameters.</li> <li>• A failure has occurred in the USB memory device while copying the parameters or reading the PLC function project data.</li> </ul>	
<b>Check point</b>	<ul style="list-style-type: none"> <li>• -----</li> </ul>	
<b>Corrective action</b>	<ul style="list-style-type: none"> <li>• Perform parameter copy again. (Refer to <a href="#">page 744</a> and <a href="#">page 747</a>.)</li> <li>• Perform PLC function project data copy again. (Refer to <a href="#">page 646</a>.)</li> <li>• The USB memory device may be faulty. Replace the USB memory device.</li> <li>• The operation panel (FR-DU08) may be faulty. Contact your sales representative.</li> </ul>	

<b>Operation panel indication</b>	<b>rE2</b>	<b>rE2</b>
<b>Name</b>	Parameter write error	
<b>Description</b>	<ul style="list-style-type: none"> <li>• Parameter copy from the operation panel to the inverter was attempted during operation.</li> <li>• A failure has occurred at the operation panel side EEPROM while writing the copied parameters.</li> <li>• A failure has occurred in the USB memory device while writing the copied parameters or PLC function project data.</li> </ul>	
<b>Check point</b>	<ul style="list-style-type: none"> <li>• Check that the inverter is stopped.</li> </ul>	
<b>Corrective action</b>	<ul style="list-style-type: none"> <li>• After stopping the operation, perform parameter copy again. (Refer to <a href="#">page 744</a>.)</li> <li>• The operation panel (FR-DU08) may be faulty. Contact your sales representative.</li> <li>• Perform parameter copy or PLC project data copy again. (Refer to <a href="#">page 646</a> and <a href="#">page 747</a>.)</li> <li>• The USB memory device may be faulty. Replace the USB memory device.</li> </ul>	

<b>Operation panel indication</b>	<b>rE3</b>	<b>rE3</b>
<b>Name</b>	Parameter verification error	
<b>Description</b>	<ul style="list-style-type: none"> <li>• The data in the inverter are different from the data in the operation panel.</li> <li>• A failure has occurred at the operation panel side EEPROM during parameter verification.</li> <li>• A failure has occurred in the USB memory device during parameter verification.</li> <li>• The data in the inverter are different from the data in the USB memory device or the personal computer (FR Configurator2).</li> </ul>	
<b>Check point</b>	<ul style="list-style-type: none"> <li>• Check the parameter setting of the source inverter against the setting of the destination inverter.</li> </ul>	
<b>Corrective action</b>	<ul style="list-style-type: none"> <li>• Continue the verification by pressing <input type="button" value="SET"/>.</li> <li>• Perform parameter verification again. (Refer to <a href="#">page 746</a>.)</li> <li>• The operation panel (FR-DU08) may be faulty. Contact your sales representative.</li> <li>• The USB memory device may be faulty. Replace the USB memory device.</li> <li>• Verify the PLC function project data again. (Refer to <a href="#">page 646</a>.)</li> </ul>	

Operation panel indication	rE4	rE4
Name	Model error	
Description	<ul style="list-style-type: none"> <li>The series of the source inverter used to copy or verify parameters is not the same as the target inverter.</li> <li>The operation panel data was incorrect when attempting to verify parameters or copy parameters from the operation panel to the inverter.</li> </ul>	
Check point	<ul style="list-style-type: none"> <li>Check that the source inverter being used to verify or copy parameters is the same series as the target inverter.</li> <li>Check that the copying of parameters was not interrupted due to a loss of power to the inverter or the operation panel being disconnected.</li> </ul>	
Corrective action	<ul style="list-style-type: none"> <li>Use a source inverter that is the same series (FR-A800 series) as the target inverter.</li> <li>Try to copy the parameters to the operation panel from the inverter again.</li> </ul>	

Operation panel indication	rE5	rE5
Name	File error	
Description	<ul style="list-style-type: none"> <li>The data in the USB memory device may be damaged.</li> </ul>	
Check point	<ul style="list-style-type: none"> <li>-----</li> </ul>	
Corrective action	<ul style="list-style-type: none"> <li>Delete the copy file in the USB memory device and perform parameter copy again.</li> </ul>	

Operation panel indication	rE6	rE6
Name	File error	
Description	<ul style="list-style-type: none"> <li>The parameter copy file in the USB memory device cannot be recognized.</li> <li>An error has occurred in the file system during transfer of the PLC function data or writing to RAM.</li> </ul>	
Check point	<ul style="list-style-type: none"> <li>-----</li> </ul>	
Corrective action	<ul style="list-style-type: none"> <li>Perform parameter copy again. (Refer to <a href="#">page 747</a>.)</li> <li>Copy the PLC function project data again. (Refer to <a href="#">page 646</a>.)</li> </ul>	

Operation panel indication	rE7	rE7
Name	File quantity error	
Description	<ul style="list-style-type: none"> <li>A parameter copy was attempted to the USB memory device in which the copy files from 001 to 099 had already been saved.</li> </ul>	
Check point	<ul style="list-style-type: none"> <li>Check if the number of copy files in the USB memory device has reached 99.</li> </ul>	
Corrective action	<ul style="list-style-type: none"> <li>Delete the copy file in the USB memory device and perform parameter copy again. (Refer to <a href="#">page 747</a>.)</li> </ul>	

Operation panel indication	rE8	rE8
Name	No PLC function project file	
Description	The specified PLC function project file does not exist in the USB memory device.	
Check point	<ul style="list-style-type: none"> <li>Check that the file exists in the USB memory device.</li> <li>Check that the folder name and the file name in the USB memory device is correct.</li> </ul>	
Corrective action	The data in the USB memory device may be damaged.	

Operation panel indication	Err.	Err.
Description	<ul style="list-style-type: none"> <li>The RES signal is turned ON.</li> <li>The operation panel and inverter cannot make normal communication (contact faults of the connector).</li> <li>This error may occur when the voltage at the input side of the inverter drops.</li> <li>When using a separate power source for the control circuit power (R1/L11, S1/L21) from the main circuit power (R/L1, S/L2, T/L3), this error may appear at turning ON of the main circuit. It is not a fault.</li> </ul>	
Corrective action	<ul style="list-style-type: none"> <li>Turn OFF the RES signal.</li> <li>Check the connection between the operation panel and the inverter.</li> <li>Check the voltage on the input side of the inverter.</li> </ul>	

## ◆ Warning





Output is not shut off when a protective function is activated.

Operation panel indication	OL		FR-LU08 indication	OL
<b>Name</b>	Stall prevention (overcurrent)			
<b>Description</b>	<ul style="list-style-type: none"> <li>When the output current of the inverter increases, the stall prevention (overcurrent) function is activated.</li> <li>The following section explains about the stall prevention (overcurrent) function.</li> </ul>			
	During acceleration	When the output current (output torque under Real sensorless vector control or Vector control) of the inverter exceeds the stall prevention level ( <b>Pr.22 Stall prevention operation level</b> , etc.), this function stops the increase in frequency until the overload current decreases to prevent the inverter from resulting in overcurrent trip. When the overload current is reduced below stall prevention operation level, this function increases the frequency again.		
	During constant-speed operation	When the output current (output torque under Real sensorless vector control or Vector control) of the inverter exceeds the stall prevention level ( <b>Pr.22 Stall prevention operation level</b> , etc.), this function reduces frequency until the overload current decreases to prevent the inverter from resulting in overcurrent trip. When the overload current is reduced below stall prevention operation level, this function increases the frequency up to the set value.		
	During deceleration	When the output current (output torque under Real sensorless vector control or Vector control) of the inverter exceeds the stall prevention level ( <b>Pr.22 Stall prevention operation level</b> , etc.), this function stops the decrease in frequency until the overload current decreases to prevent the inverter from resulting in overcurrent trip. When the overload current is reduced below stall prevention operation level, this function decreases the frequency again.		
<b>Check point</b>	<ul style="list-style-type: none"> <li>Check that the <b>Pr.0 Torque boost</b> setting is not too large.</li> <li>The <b>Pr.7 Acceleration time</b> and Pr.8 Deceleration time settings may be too short.</li> <li>Check that the load is not too heavy.</li> <li>Check for any failures in peripheral devices.</li> <li>Check that the <b>Pr.13 Starting frequency</b> is not too large.</li> <li>Check that <b>Pr.22 Stall prevention operation level</b> is appropriate.</li> </ul>			
<b>Corrective action</b>	<ul style="list-style-type: none"> <li>Gradually increase or decrease the <b>Pr.0</b> setting by 1% at a time and check the motor status. (Refer to <a href="#">page 706</a>.)</li> <li>Set a larger value in <b>Pr.7</b> and Pr.8. (Refer to <a href="#">page 367</a>.)</li> <li>Reduce the load.</li> <li>Try Advanced magnetic flux vector control, Real sensorless vector control, or Vector control.</li> <li>Change the <b>Pr.14 Load pattern selection</b> setting.</li> <li>The stall prevention operation current can be set in <b>Pr.22 Stall prevention operation level</b>. (Initial value is 150%.) The acceleration/deceleration time may change. Increase the stall prevention operation level with <b>Pr.22 Stall prevention operation level</b>, or disable stall prevention with <b>Pr.156 Stall prevention operation selection</b>. (Use <b>Pr.156</b> to set either operation continued or not at OL operation.)</li> </ul>			

Operation panel indication	oL		FR-LU08 indication	oL
<b>Name</b>	Stall prevention (overvoltage)			
<b>Description</b>	<ul style="list-style-type: none"> <li>When the output voltage of the inverter increases, the stall prevention (overvoltage) function is activated.</li> <li>The regeneration avoidance function is activated due to excessive regenerative power of the motor. (Refer to <a href="#">page 732</a>.)</li> <li>The following section explains the stall prevention (overvoltage) function.</li> </ul>			
	During deceleration	If the regenerative power of the motor becomes excessive to exceed the regenerative power consumption capability, this function stops decreasing the frequency to prevent overvoltage trip. As soon as the regenerative power has reduced, deceleration resumes.		
<b>Check point</b>	<ul style="list-style-type: none"> <li>Check for sudden speed reduction.</li> <li>Check if the regeneration avoidance function (<b>Pr.882 to Pr.886</b>) is being used. (Refer to <a href="#">page 732</a>.)</li> </ul>			
<b>Corrective action</b>	The deceleration time may change. Increase the deceleration time using <b>Pr.8 Deceleration time</b> .			

Operation panel indication	RB		FR-LU08 indication	RB
<b>Name</b>	Regenerative brake pre-alarm (Standard models only)			
<b>Description</b>	Appears if the regenerative brake duty reaches or exceeds 85% of the <b>Pr.70 Special regenerative brake duty</b> value. If the regenerative brake duty reaches 100%, a regenerative overvoltage (E. OV[ ]) occurs.			
<b>Check point</b>	<ul style="list-style-type: none"> <li>Check if the brake resistor duty is not too high.</li> <li>Check that the <b>Pr.30 Regenerative function selection</b> and Pr.70 settings are correct.</li> </ul>			
<b>Corrective action</b>	<ul style="list-style-type: none"> <li>Set the deceleration time longer.</li> <li>Check the <b>Pr.30</b> and Pr.70 settings. (Refer to <a href="#">page 724</a>.)</li> </ul>			

Operation panel indication	TH		FR-LU08 indication	TH
Name	Electronic thermal relay function pre-alarm			
Description	Appears if the cumulative value of the electronic thermal O/L relay reaches or exceeds 85% of the preset level of <b>Pr.9 Electronic thermal O/L relay</b> . If the specified value is reached, the protection circuit is activated to shut off the inverter output.			
Check point	<ul style="list-style-type: none"> <li>• Check for large load or sudden acceleration.</li> <li>• Check that the <b>Pr.9</b> setting is appropriate. (Refer to <a href="#">page 415</a>.)</li> </ul>			
Corrective action	<ul style="list-style-type: none"> <li>• Reduce the load and frequency of operation.</li> <li>• Set an appropriate value in <b>Pr.9</b>. (Refer to <a href="#">page 415</a>.)</li> </ul>			

Operation panel indication	PS		FR-LU08 indication	PS
Name	PU stop			
Description	<ul style="list-style-type: none"> <li>• The motor is stopped using  under the mode other than the PU operation mode. (To enable  under the mode other than the PU operation mode, set <b>Pr.75 Reset selection/disconnected PU detection/PU stop selection</b>. Refer to <a href="#">page 336</a> for details.)</li> <li>• The motor is stopped by the emergency stop function.</li> </ul>			
Check point	<ul style="list-style-type: none"> <li>• Check for a stop made by pressing  of the operation panel.</li> <li>• Check for whether the X92 signal is OFF.</li> </ul>			
Corrective action	<ul style="list-style-type: none"> <li>• Turn the start signal OFF and release with .</li> <li>• Turn ON the X92 signal and OFF the start signal for release.</li> </ul>			

Operation panel indication	SL		FR-LU08 indication	SL
Name	Speed limit indication (output during speed limit)			
Description	Output if the speed limit level is exceeded during torque control.			
Check point	<ul style="list-style-type: none"> <li>• Check that the torque command is not larger than required.</li> <li>• Check if the speed limit level is set too low.</li> </ul>			
Corrective action	<ul style="list-style-type: none"> <li>• Decrease the torque command value.</li> <li>• Increase the speed limit level.</li> </ul>			

Operation panel indication	CP		FR-LU08 indication	CP
Name	Parameter copy			
Description	Appears when parameter copy is performed between the FR-A820-03160(55K) or lower / FR-A840-01800(55K) or lower inverters and the FR-A820-03800(75K) or higher / FR-A840-02160(75K) or higher inverters.			
Check point	Resetting of <b>Pr.9, Pr.30, Pr.51, Pr.56, Pr.57, Pr.61, Pr.70, Pr.72, Pr.80, Pr.82, Pr.90 to Pr.94, Pr.453, Pr.455, Pr.458 to Pr.462, Pr.557, Pr.859, Pr.860, and Pr.893</b> is necessary.			
Corrective action	Set the initial value in <b>Pr.989 Parameter copy alarm release</b> .			

Operation panel indication	SA		FR-LU08 indication	—
Name	Safety stop			
Description	Appears when safety stop function is activated (during output shutoff). (Refer to <a href="#">page 82</a> .)			
Check point	<ul style="list-style-type: none"> <li>• Check if an emergency stop device is activated.</li> <li>• Check if the shorting wire between S1 and PC or between S2 and PC is disconnected when not using the safety stop function.</li> </ul>			
Corrective action	<ul style="list-style-type: none"> <li>• An emergency stop device is active when using the safety stop function. Identify the cause of emergency stop, ensure the safety and restart the system.</li> <li>• When not using the safety stop function, short across terminals S1 and PC and across S2 and PC with shorting wire for the inverter to run.</li> <li>• If "SA" is indicated when wires across S1 and SIC and across S2 and SIC are both conducted while using the safety stop function (drive enabled), internal failure might be the cause. Check the wiring of terminals S1, S2, and SIC and contact your sales representative if the wiring has no fault.</li> </ul>			

Operation panel indication	MT1 to MT3	MF 1 to MF 3	FR-LU08 indication	MT1 to MT3
Name	Maintenance signal output			
Description	Appears when the inverter's cumulative energization time reaches or exceeds the parameter set value. Set the time until the MT is displayed using <b>Pr.504 Maintenance timer 1 warning output set time (MT1)</b> , <b>Pr.687 Maintenance timer 2 warning output set time (MT2)</b> , and <b>Pr.689 Maintenance timer 3 warning output set time (MT3)</b> . MT does not appear when the settings of <b>Pr.504</b> , <b>Pr.687</b> , and <b>Pr.689</b> are initial values (9999).			
Check point	The set time of maintenance timer has been exceeded. (Refer to <a href="#">page 363</a> .)			
Corrective action	Take appropriate countermeasures according to the purpose of the maintenance timer setting. Setting "0" in <b>Pr.503 Maintenance timer 1</b> , <b>Pr.686 Maintenance timer 2</b> , and <b>Pr.688 Maintenance timer 3</b> clears the indication.			

Operation panel indication	UF	UF	FR-LU08 indication	UF
Name	USB host error			
Description	Appears when an excessive current flows into the USB A connector.			
Check point	Check if a USB device other than a USB memory device is connected to the USB A connector.			
Corrective action	<ul style="list-style-type: none"> <li>• If a device other than a USB memory device is connected to the USB A connector, remove the device.</li> <li>• Setting <b>Pr.1049 USB host reset</b> = "1" or inverter reset clears the UF indication.</li> </ul>			

Operation panel indication	HP1 to HP3	HP 1 to HP 3	FR-LU08 indication	HP1 to HP3
Name	Home position return error			
Description	Appears when an error occurs during the home position return operation under position control. For the details, refer to <a href="#">page 313</a> .			
Check point	Identify the cause of the error occurrence.			
Corrective action	Check the parameter setting, and check that the input signal is correct.			

Operation panel indication	CF	CF	FR-LU08 indication	CF
Name	Continuous operation during communication fault			
Description	Appears when the operation continues while an error is occurring in the communication line or communication option (when <b>Pr.502</b> = "4").			
Check point	<ul style="list-style-type: none"> <li>• Check for a break in the communication cable.</li> <li>• Check for communication option faults.</li> </ul>			
Corrective action	<ul style="list-style-type: none"> <li>• Check the connection of communication cable.</li> <li>• Replace the communication option.</li> </ul>			

Operation panel indication	LDF	LdF	FR-LU08 indication	LDF
Name	Load fault warning			
Description	Appears when the load is deviated from the detection width set in <b>Pr.1488 Upper limit warning detection width</b> or <b>Pr.1489 Lower limit warning detection width</b> .			
Check point	<ul style="list-style-type: none"> <li>• Check if too much load is applied to the equipment, or if the load is too light.</li> <li>• Check that the load characteristics settings are correct.</li> </ul>			
Corrective action	<ul style="list-style-type: none"> <li>• Inspect the equipment.</li> <li>• Set the load characteristics (<b>Pr.1481 to Pr.1487</b>) correctly.</li> </ul>			

## ◆ Alarm

Output is not shut off when a protective function is activated. The Alarm (LF) signal can be output depending on the parameter setting. (Set "98" in **Pr.190 to Pr.196 (Output terminal function selection)**. Refer to [page 473.](#))

Operation panel indication	FN		FR-LU08 indication	FN
Name	Fan alarm			
Description	For the inverter that contains a cooling fan, FN appears on the operation panel when the cooling fan stops due to a fault, low rotation speed, or different operation from the setting of <b>Pr.244 Cooling fan operation selection</b> .			
Check point	When the cooling fan is replaced, check that the fan is not installed upside down. Check the cooling fan for a failure.			
Corrective action	Install the fan correctly. (Refer to <a href="#">page 815.</a> ) If the fan alarm still occurs after the fan is installed correctly, the fan may be faulty. Contact your sales representative.			

Operation panel indication	FN2		FR-LU08 indication	FN2
Name	Internal fan alarm (IP55 compatible models only)			
Description	FN2 appears on the operation panel when the internal air circulation fan stops due to a fault or low rotation speed.			
Check point	Check the internal air circulation fan for a failure.			
Corrective action	The fan may be faulty. Contact your sales representative.			

## ◆ Fault

When a protective function is activated, the inverter output is shut off and a Fault signal is output.

Operation panel indication	E.OC1		FR-LU08 indication	OC During Acc
Name	Overcurrent trip during acceleration			
Description	When the inverter output current reaches or exceeds approximately 235%*1 of the rated current during acceleration, the protection circuit is activated and the inverter output is shut off.			
Check point	<ul style="list-style-type: none"> <li>• Check for sudden speed acceleration.</li> <li>• Check if the downward acceleration time is too long in a lift application.</li> <li>• Check for output short-circuit.</li> <li>• Check that the <b>Pr.3 Base frequency</b> setting is not 60 Hz when the motor rated frequency is 50 Hz.</li> <li>• Check if the stall prevention operation level is set too high. Check if the fast-response current limit operation is disabled.</li> <li>• Check that the regenerative driving is not performed frequently. (Check if the output voltage becomes larger than the V/F reference voltage at regenerative driving and overcurrent occurs due to increase in the motor current.)</li> <li>• Check that the power supply for RS-485 terminal is not shorted (under Vector control).</li> <li>• Check that the encoder wiring and the specifications (encoder power supply, resolution, differential/complementary) are correct. Check also that the motor wiring (U, V, W) is correct (under Vector control).</li> <li>• Check that the rotation direction is not switched from forward to reverse rotation (or from reverse to forward) during torque control under Real sensorless vector control.</li> <li>• Check that the inverter capacity matches with the motor capacity. (PM sensorless vector control)</li> <li>• Check if a start command is given to the inverter while the motor is coasting. (PM sensorless vector control)</li> </ul>			
Corrective action	<ul style="list-style-type: none"> <li>• Set the acceleration time longer. (Shorten the downward acceleration time of the lift.)</li> <li>• If "E.OC1" always appears at start, disconnect the motor once and restart the inverter. If "E.OC1" still appears, contact your sales representative.</li> <li>• Check the wiring to make sure that output short circuit does not occur.</li> <li>• Set 50 Hz in <b>Pr.3 Base frequency</b>. (Refer to <a href="#">page 707.</a>)</li> <li>• Lower the stall prevention operation level. Activate the fast-response current limit operation. (Refer to <a href="#">page 431.</a>)</li> <li>• Set the base voltage (rated voltage of the motor, etc.) in <b>Pr.19 Base frequency voltage</b>. (Refer to <a href="#">page 707.</a>)</li> <li>• Check RS-485 terminal connection (under Vector control).</li> <li>• Check the wiring and specifications of the encoder and the motor. Perform the setting according to the specifications of the encoder and the motor (under vector control). (Refer to <a href="#">page 87.</a>)</li> <li>• Prevent the motor from switching the rotation direction from forward to reverse (or from reverse to forward) during torque control under Real sensorless vector control.</li> <li>• Choose inverter and motor capacities that match. (PM sensorless vector control)</li> <li>• Input a start command after the motor stops. Alternatively, use the automatic restart after instantaneous power failure/flying start function. (Refer to <a href="#">page 635.</a>) (PM sensorless vector control)</li> </ul>			

\*1 Differs according to ratings. The rating can be changed using **Pr.570 Multiple rating setting**. (Refer to [page 343.](#))  
148% for SLD rating, 170% for LD rating, 235% for ND rating (initial setting), and 280% for HD rating

<b>Operation panel indication</b>	<b>E.OC2</b>	<b>E. OC2</b>	<b>FR-LU08 indication</b>	<b>OC During Cnst Spd</b>
<b>Name</b>	Overcurrent trip during constant speed			
<b>Description</b>	When the inverter output current reaches or exceeds approximately 235% <sup>*2</sup> of the rated current during constant-speed operation, the protection circuit is activated and the inverter output is shut off.			
<b>Check point</b>	<ul style="list-style-type: none"> <li>• Check for sudden load change.</li> <li>• Check for a short-circuit in the output circuit.</li> <li>• Check if the stall prevention operation level is set too high. Check if the fast-response current limit operation is disabled.</li> <li>• Check that the power supply for RS-485 terminal is not shorted (under Vector control).</li> <li>• Check that the rotation direction is not switched from forward to reverse rotation (or from reverse to forward) during torque control under Real sensorless vector control.</li> <li>• Check that the inverter capacity matches with the motor capacity. (PM sensorless vector control)</li> <li>• Check if a start command is given to the inverter while the motor is coasting. (PM sensorless vector control)</li> </ul>			
<b>Corrective action</b>	<ul style="list-style-type: none"> <li>• Keep the load stable.</li> <li>• Check the wiring to make sure that output short circuit does not occur.</li> <li>• Lower the stall prevention operation level. Activate the fast-response current limit operation. (Refer to <a href="#">page 431.</a>)</li> <li>• Check RS-485 terminal connection (under Vector control).</li> <li>• Prevent the motor from switching the rotation direction from forward to reverse (or from reverse to forward) during torque control under Real sensorless vector control.</li> <li>• Choose inverter and motor capacities that match. (PM sensorless vector control)</li> <li>• Input a start command after the motor stops. Alternatively, use the automatic restart after instantaneous power failure/flying start function. (Refer to <a href="#">page 635.</a>) (PM sensorless vector control)</li> </ul>			

\*2 Differs according to ratings. The rating can be changed using **Pr.570 Multiple rating setting**. (Refer to [page 343.](#))  
148% for SLD rating, 170% for LD rating, 235% for ND rating (initial setting), and 280% for HD rating

<b>Operation panel indication</b>	<b>E.OC3</b>	<b>E. OC3</b>	<b>FR-LU08 indication</b>	<b>OC During Dec</b>
<b>Name</b>	Overcurrent trip during deceleration or stop			
<b>Description</b>	When the inverter output current reaches or exceeds approximately 235% <sup>*3</sup> of the rated current during deceleration (other than acceleration or constant speed), the protection circuit is activated and the inverter output is shut off.			
<b>Check point</b>	<ul style="list-style-type: none"> <li>• Check for sudden speed reduction.</li> <li>• Check for a short-circuit in the output circuit.</li> <li>• Check for too fast operation of the motor's mechanical brake.</li> <li>• Check if the stall prevention operation level is set too high. Check if the fast-response current limit operation is disabled.</li> <li>• Check that the power supply for RS-485 terminal is not shorted (under Vector control).</li> <li>• Check that the rotation direction is not switched from forward to reverse rotation (or from reverse to forward) during torque control under Real sensorless vector control.</li> <li>• Check that the inverter capacity matches with the motor capacity. (PM sensorless vector control)</li> <li>• Check if a start command is given to the inverter while the motor is coasting. (PM sensorless vector control)</li> </ul>			
<b>Corrective action</b>	<ul style="list-style-type: none"> <li>• Set the deceleration time longer.</li> <li>• Check the wiring to make sure that output short circuit does not occur.</li> <li>• Check the mechanical brake operation.</li> <li>• Lower the stall prevention operation level. Activate the fast-response current limit operation. (Refer to <a href="#">page 431.</a>)</li> <li>• Check RS-485 terminal connection (under Vector control).</li> <li>• Prevent the motor from switching the rotation direction from forward to reverse (or from reverse to forward) during torque control under Real sensorless vector control.</li> <li>• Choose inverter and motor capacities that match. (PM sensorless vector control)</li> <li>• Input a start command after the motor stops. Alternatively, use the automatic restart after instantaneous power failure/flying start function. (Refer to <a href="#">page 635.</a>) (PM sensorless vector control)</li> </ul>			

\*3 Differs according to ratings. The rating can be changed using **Pr.570 Multiple rating setting**. (Refer to [page 343.](#))  
148% for SLD rating, 170% for LD rating, 235% for ND rating (initial setting), and 280% for HD rating



Operation panel indication	E.OV1	E. OV 1	FR-LU08 indication	OV During Acc
Name	Regenerative overvoltage trip during acceleration			
Description	If regenerative power causes the inverter's internal main circuit DC voltage to reach or exceed the specified value, the protection circuit is activated to stop the inverter output. The circuit may also be activated by a surge voltage produced in the power supply system.			
Check point	<ul style="list-style-type: none"> <li>• Check for too slow acceleration. (e.g. during downward acceleration in vertical lift load)</li> <li>• Check that the <b>Pr.22 Stall prevention operation level</b> is not set to the no load current or lower.</li> <li>• Check if the stall prevention operation is frequently activated in an application with a large load inertia.</li> </ul>			
Corrective action	<ul style="list-style-type: none"> <li>• Set the acceleration time shorter.</li> <li>• Use the regeneration avoidance function (<b>Pr.882 to Pr.886</b>). (Refer to <a href="#">page 732</a>.)</li> <li>• Set a value larger than the no load current in <b>Pr.22</b>.</li> <li>• Set <b>Pr.154 Voltage reduction selection during stall prevention operation</b> = "10 or 11". (Refer to <a href="#">page 431</a>.)</li> </ul>			

Operation panel indication	E.OV2	E. OV 2	FR-LU08 indication	OV During Cnst Spd
Name	Regenerative overvoltage trip during constant speed			
Description	If regenerative power causes the inverter's internal main circuit DC voltage to reach or exceed the specified value, the protection circuit is activated to stop the inverter output. The circuit may also be activated by a surge voltage produced in the power supply system.			
Check point	<ul style="list-style-type: none"> <li>• Check for sudden load change.</li> <li>• Check that the <b>Pr.22 Stall prevention operation level</b> is not set to the no load current or lower.</li> <li>• Check if the stall prevention operation is frequently activated in an application with a large load inertia.</li> <li>• Check that acceleration/deceleration time is not too short.</li> </ul>			
Corrective action	<ul style="list-style-type: none"> <li>• Keep the load stable.</li> <li>• Use the regeneration avoidance function (<b>Pr.882 to Pr.886</b>). (Refer to <a href="#">page 732</a>.)</li> <li>• Use the brake unit, multifunction regeneration converter (FR-XC), or power regeneration common converter (FR-CV) as required.</li> <li>• Set a value larger than the no load current in <b>Pr.22</b>.</li> <li>• Set <b>Pr.154 Voltage reduction selection during stall prevention operation</b> = "10 or 11". (Refer to <a href="#">page 431</a>.)</li> <li>• Set the acceleration/deceleration time longer. (Under Vector control or Advanced magnetic flux vector control, the output torque can be increased. However, sudden acceleration may cause an overshoot in speed, resulting in an occurrence of overvoltage.)</li> </ul>			

Operation panel indication	E.OV3	E. OV 3	FR-LU08 indication	OV During Dec
Name	Regenerative overvoltage trip during deceleration or stop			
Description	If regenerative power causes the inverter's internal main circuit DC voltage to reach or exceed the specified value, the protection circuit is activated to stop the inverter output. The circuit may also be activated by a surge voltage produced in the power supply system.			
Check point	<ul style="list-style-type: none"> <li>• Check for sudden speed reduction.</li> <li>• Check if the stall prevention operation is frequently activated in an application with a large load inertia.</li> </ul>			
Corrective action	<ul style="list-style-type: none"> <li>• Set the deceleration time longer. (Set the deceleration time which matches the moment of inertia of the load.)</li> <li>• Make the brake cycle longer.</li> <li>• Use the regeneration avoidance function (<b>Pr.882 to Pr.886</b>). (Refer to <a href="#">page 732</a>.)</li> <li>• Use the brake unit, multifunction regeneration converter (FR-XC), or power regeneration common converter (FR-CV) as required.</li> <li>• Set <b>Pr.154 Voltage reduction selection during stall prevention operation</b> = "10 or 11". (Refer to <a href="#">page 431</a>.)</li> </ul>			

Operation panel indication	E.THT	E. THT	FR-LU08 indication	Inv. overload trip
Name	Inverter overload trip (Electronic thermal O/L relay) <sup>*4</sup>			
Description	If the temperature of the output transistor elements exceeds the protection level with a rated output current or higher flowing without the overcurrent trip (E.OC[]), the inverter output is stopped. (Overload capacity 150% 60 s)			
Check point	<ul style="list-style-type: none"> <li>• Check that acceleration/deceleration time is not too short.</li> <li>• Check that torque boost setting is not too large (small).</li> <li>• Check that load pattern selection setting is appropriate for the load pattern of the using machine.</li> <li>• Check the motor for the use under overload.</li> <li>• Check that the encoder wiring and the specifications (encoder power supply, resolution, differential/complementary) are correct. Check also that the motor wiring (U, V, W) is correct (under Vector control).</li> </ul>			
Corrective action	<ul style="list-style-type: none"> <li>• Set the acceleration/deceleration time longer.</li> <li>• Adjust the torque boost setting.</li> <li>• Set the load pattern selection setting according to the load pattern of the using machine.</li> <li>• Reduce the load.</li> <li>• Check the wiring and specifications of the encoder and the motor. Perform the setting according to the specifications of the encoder and the motor (under vector control). (Refer to <a href="#">page 87</a>.)</li> </ul>			



\*4 Resetting the inverter initializes the internal cumulative heat value of the electronic thermal O/L relay function.

Operation panel indication	E.THM	E. THM	FR-LU08 indication	Motor Ovrload
Name	Motor overload trip (electronic thermal relay function) <sup>*5</sup>			
Description	The electronic thermal O/L relay function in the inverter detects motor overload, which is caused by overload or reduced cooling capability during low-speed operation. When the cumulative heat value reaches 85% of the <b>Pr.9 Electronic thermal O/L relay</b> setting, pre-alarm (TH) is output. When the accumulated value reaches the specified value, the protection circuit is activated to stop the inverter output. When the inverter is used to drive a dedicated motor, such as a multiple-pole motor, or several motors, the motor cannot be protected by the electronic thermal O/L relay. Install an external thermal relay on the inverter output side.			
Check point	<ul style="list-style-type: none"> <li>• Check the motor for the use under overload.</li> <li>• Check that the setting of <b>Pr.71 Applied motor</b> for motor selection is correct. (Refer to <a href="#">page 528</a>.)</li> <li>• Check that the stall prevention operation setting is correct.</li> </ul>			
Corrective action	<ul style="list-style-type: none"> <li>• Reduce the load.</li> <li>• For a constant-torque motor, set the constant-torque motor in <b>Pr.71</b>.</li> <li>• Set the stall prevention operation level accordingly. (Refer to <a href="#">page 431</a>.)</li> </ul>			

\*5 Resetting the inverter initializes the internal cumulative heat value of the electronic thermal relay function.

Operation panel indication	E.FIN	E. FIN	FR-LU08 indication	Heatsink overheat
Name	Heat sink overheat			
Description	When the heat sink overheats, the temperature sensor is activated, and the inverter output is stopped. The FIN signal can be output when the temperature becomes approximately 85% of the heat sink overheat protection operation temperature. For the terminal used for the FIN signal output, assign the function by setting "26 (positive logic) or 126 (negative logic)" from <b>Pr.190 to Pr.196 (Output terminal function selection)</b> . (Refer to <a href="#">page 473</a> .)			
Check point	<ul style="list-style-type: none"> <li>• Check for too high surrounding air temperature.</li> <li>• Check for heat sink clogging.</li> <li>• Check that the cooling fan is not stopped. (Check that FN is not displayed on the operation panel.)</li> </ul>			
Corrective action	<ul style="list-style-type: none"> <li>• Set the surrounding air temperature to within the specifications.</li> <li>• Clean the heat sink.</li> <li>• Replace the cooling fan.</li> </ul>			

Operation panel indication	E.IPF	E. IPF	FR-LU08 indication	Instant Pwr failure
Name	Instantaneous power failure (Standard models and IP55 compatible models only)			
Description	If a power failure occurs (or when power input to the inverter is shut off) for longer than 15 ms <sup>*6</sup> , the instantaneous power failure protective function is activated to shut off the inverter output in order to prevent the control circuit from malfunctioning. If a power failure persists for 100 ms or longer, the fault warning output is not provided, and the inverter restarts if the start signal is ON upon power restoration. (The inverter continues operating if an instantaneous power failure is within 15 ms <sup>*6</sup> .) In some operating status (load magnitude, acceleration/deceleration time setting, etc.), overcurrent or other protection may be activated upon power restoration. When instantaneous power failure protection is activated, the IPF signal is output. (Refer to <a href="#">page 628</a> and <a href="#">page 635</a> .)			
Check point	Find the cause of instantaneous power failure occurrence.			
Corrective action	<ul style="list-style-type: none"> <li>• Remedy the instantaneous power failure.</li> <li>• Prepare a backup power supply for instantaneous power failure.</li> <li>• Set the function of automatic restart after instantaneous power failure (<b>Pr.57</b>). (Refer to <a href="#">page 628</a> and <a href="#">page 635</a>.)</li> </ul>			

\*6 10 ms for IP55 compatible models

<b>Operation panel indication</b>	<b>E.UVT</b>	<b>E. UVF</b>	<b>FR-LU08 indication</b>	<b>Under Voltage</b>
<b>Name</b>	Undervoltage (Standard models and IP55 compatible models only)			
<b>Description</b>	<p>If the power supply voltage of the inverter decreases, the control circuit will not perform normal functions. In addition, the motor torque will be insufficient and/or heat generation will increase. To prevent this, if the power supply voltage decreases to about 150 VAC (300 VAC for the 400 V class) or below, this function shuts off the inverter output.</p> <p>When a jumper is not connected across P/+ and P1, the undervoltage protective function is activated.</p> <p>When undervoltage protection is activated, the IPF signal is output. (Refer to <a href="#">page 628</a> and <a href="#">page 635</a>.)</p>			
<b>Check point</b>	<ul style="list-style-type: none"> <li>• Check if a high-capacity motor is driven.</li> <li>• Check if the jumper is connected across terminals P/+ and P1.</li> </ul>			
<b>Corrective action</b>	<ul style="list-style-type: none"> <li>• Check the devices on the power supply line such as the power supply itself. If this function is activated due to unstable voltage in the power supply, change the undervoltage level (DC bus voltage value). (Refer to <a href="#">page 425</a>.)</li> <li>• Do not remove the jumper across terminals P/+ and P1 except when connecting a DC reactor.</li> <li>• If the problem still persists after taking the above measure, contact your sales representative.</li> </ul>			

<b>Operation panel indication</b>	<b>E.ILF</b>	<b>E. ILF</b>	<b>FR-LU08 indication</b>	<b>Input phase loss</b>
<b>Name</b>	Input phase loss (Standard models and IP55 compatible models only)			
<b>Description</b>	<p>When <b>Pr.872 Input phase loss protection selection</b> is enabled ("1") and one of the three-phase power input is lost, the inverter output is shut off. This protective function is not available when <b>Pr.872</b> is set to the initial value (<b>Pr.872</b> = "0"). (Refer to <a href="#">page 426</a>.)</p>			
<b>Check point</b>	Check for a break in the cable for the three-phase power supply input.			
<b>Corrective action</b>	<ul style="list-style-type: none"> <li>• Wire the cables properly.</li> <li>• Repair a break portion in the cable.</li> </ul>			

<b>Operation panel indication</b>	<b>E.OLT</b>	<b>E. OLF</b>	<b>FR-LU08 indication</b>	<b>Stall prevention STP</b>
<b>Name</b>	Stall prevention stop			
<b>Description</b>	<p><b>V/F</b> <b>Magnetic flux</b></p> <p>If the output frequency has fallen to 0.5 Hz by stall prevention operation and remains for 3 seconds, a fault (E.OLT) appears and the inverter is shut off. OL appears while stall prevention is being activated.</p> <p><b>Sensorless Vector PM</b></p> <p>When speed control is performed, a fault (E.OLT) appears and the inverter output is shut off if frequency drops to the <b>Pr.865 Low speed detection</b> (initial value is 1.5 Hz) setting by torque limit operation and the output torque exceeds the <b>Pr.874 OLT level setting</b> (initial value is 150%) setting and remains 3 seconds.</p>			
<b>Check point</b>	<ul style="list-style-type: none"> <li>• Check the motor for the use under overload.</li> <li>• Check that the <b>Pr.865</b> and <b>Pr.874</b> values are correct. (Check the <b>Pr.22 Stall prevention operation level</b> setting under V/F control and Advanced magnetic flux vector control.)</li> <li>• Check if a motor is connected under PM sensorless vector control.</li> </ul>			
<b>Corrective action</b>	<ul style="list-style-type: none"> <li>• Reduce the load.</li> <li>• Change the <b>Pr.22</b>, <b>Pr.865</b>, and <b>Pr.874</b> values. (Check the <b>Pr.22</b> setting under V/F control and Advanced magnetic flux vector control.)</li> <li>• For the test operation without connecting a motor, select the PM sensorless vector control test operation. (Refer to <a href="#">page 224</a>.)</li> <li>• Also check that the stall prevention (overcurrent) warning (OL) or the stall prevention (overvoltage) warning (oL) countermeasure is taken.</li> </ul>			

Operation panel indication	E.SOT 	E. SOT	FR-LU08 indication	Motor Step Out
Name	Loss of synchronism detection			
Description	The inverter output is shut off when the motor operation is not synchronized. (This function is only available under PM sensorless vector control.)			
Check point	<ul style="list-style-type: none"> <li>• Check that the PM motor is not driven overloaded.</li> <li>• Check if a start command is given to the inverter while the PM motor is coasting.</li> <li>• Check if a motor is connected under PM sensorless vector control.</li> <li>• Check if a PM motor other than the MM-CF series is driven.</li> </ul>			
Corrective action	<ul style="list-style-type: none"> <li>• Set the acceleration time longer.</li> <li>• Reduce the load.</li> <li>• If the inverter restarts during coasting, set <b>Pr.57 Restart coasting time</b> ≠ "9999", and select the automatic restart after instantaneous power failure.</li> <li>• Check the connection of the IPM motor.</li> <li>• For the test operation without connecting a motor, select the PM sensorless vector control test operation. (Refer to <a href="#">page 224</a>.)</li> <li>• Drive an IPM motor (MM-CF series).</li> <li>• When driving an IPM motor other than MM-CF series, offline auto tuning must be performed. (Refer to <a href="#">page 551</a>.)</li> </ul>			

Operation panel indication	E.LUP	E. LUP	FR-LU08 indication	Upper limit fault
Name	Upper limit fault detection			
Description	The inverter output is shut off when the load exceeds the upper limit fault detection range. This protective function is not available in the initial setting of <b>Pr.1490</b> ( <b>Pr.1490</b> = "9999").			
Check point	<ul style="list-style-type: none"> <li>• Check if too much load is applied to the equipment.</li> <li>• Check that the load characteristics settings are correct.</li> </ul>			
Corrective action	<ul style="list-style-type: none"> <li>• Inspect the equipment.</li> <li>• Set the load characteristics (<b>Pr.1481 to Pr.1487</b>) correctly.</li> </ul>			

Operation panel indication	E.LDN	E. LDN	FR-LU08 indication	Lower limit fault
Name	Lower limit fault detection			
Description	The inverter output is shut off when the load falls below the lower limit fault detection range. This protective function is not available in the initial setting of <b>Pr.1491</b> ( <b>Pr.1491</b> = "9999").			
Check point	<ul style="list-style-type: none"> <li>• Check if the equipment load is too light.</li> <li>• Check that the load characteristics settings are correct.</li> </ul>			
Corrective action	<ul style="list-style-type: none"> <li>• Inspect the equipment.</li> <li>• Set the load characteristics (<b>Pr.1481 to Pr.1487</b>) correctly.</li> </ul>			

Operation panel indication	E.BE	E. bE	FR-LU08 indication	Brake transistor err
Name	Brake transistor alarm detection			
Description	<ul style="list-style-type: none"> <li>• The inverter output is shut off if a fault due to damage of the brake transistor and such occurs in the brake circuit. <u>In such a case, the power supply to the inverter must be shut off immediately.</u></li> <li>• Appears when an internal circuit fault occurred for separated converter types and IP55 compatible models.</li> </ul>			
Check point	<ul style="list-style-type: none"> <li>• Reduce the load inertia.</li> <li>• Check that the brake duty is proper.</li> </ul>			
Corrective action	Replace the inverter.			

Operation panel indication	E.GF	E. GF	FR-LU08 indication	Ground Fault
Name	Output side earth (ground) fault overcurrent			
Description	The inverter output is shut off if an earth (ground) fault overcurrent flows due to an earth (ground) fault that occurred on the inverter's output side (load side).			
Check point	Check for a ground fault in the motor and connection cable.			
Corrective action	Remedy the earth (ground) fault portion.			

Operation panel indication	E.LF		FR-LU08 indication	Output phase loss
Name	Output phase loss			
Description	The inverter output is shut off if one of the three phases (U, V, W) on the inverter's output side (load side) is lost.			
Check point	<ul style="list-style-type: none"> <li>• Check the wiring. (Check that the motor is normally operating.)</li> <li>• Check that the capacity of the motor used is not smaller than that of the inverter.</li> <li>• Check if a start command is given to the inverter while the motor is coasting. (PM sensorless vector control)</li> </ul>			
Corrective action	<ul style="list-style-type: none"> <li>• Wire the cables properly.</li> <li>• Input a start command after the motor stops. Alternatively, use the automatic restart after instantaneous power failure/flying start function (<a href="#">page 635</a>). (PM sensorless vector control)</li> </ul>			

Operation panel indication	E.OHT		FR-LU08 indication	Ext TH relay oper
Name	External thermal relay operation			
Description	The inverter output is shut off if the external thermal relay provided for motor overheat protection or the internally mounted thermal relay in the motor, etc. switches ON (contacts open). This function is available when "7" (OH signal) is set in any of <b>Pr.178 to Pr.189 (Input terminal function selection)</b> . This protective function is not available in the initial status. (OH signal is not assigned.)			
Check point	<ul style="list-style-type: none"> <li>• Check for motor overheating.</li> <li>• Check that the value "7" (OH signal) is set correctly to any of <b>Pr.178 to Pr.189 (Input terminal function selection)</b>.</li> </ul>			
Corrective action	<ul style="list-style-type: none"> <li>• Reduce the load and operation duty.</li> <li>• Even if the relay contacts are reset automatically, the inverter will not restart unless it is reset.</li> </ul>			

Operation panel indication	E.PTC		FR-LU08 indication	PTC thermistor oper
Name	PTC thermistor operation			
Description	The inverter output is shut off if resistance of the PTC thermistor connected between terminal 2 and terminal 10 is equal to or higher than the <b>Pr.561 PTC thermistor protection level</b> setting for a continuous time equal to or longer than the setting value in <b>Pr.1016 PTC thermistor protection detection time</b> . When the initial value ( <b>Pr.561</b> = "9999") is set, this protective function is not available.			
Check point	<ul style="list-style-type: none"> <li>• Check the connection with the PTC thermistor.</li> <li>• Check the <b>Pr.561</b> and <b>Pr.1016</b> settings.</li> <li>• Check the motor for operation under overload.</li> </ul>			
Corrective action	Reduce the load.			

Operation panel indication	E.OPT		FR-LU08 indication	Option Fault
Name	Option fault			
Description	<ul style="list-style-type: none"> <li>• Appears if the AC power supply is accidentally connected to terminal R/L1, S/L2, or T/L3 when a high power factor converter (FR-HC2), multifunction regeneration converter (FR-XC in common bus regeneration mode), or power regeneration common converter (FR-CV) is connected to the inverter while <b>Pr.30 Regenerative function selection</b> = "2".</li> <li>• Appears when torque command by the plug-in option is selected using <b>Pr.804 Torque command source selection</b> and no plug-in option is mounted. This function is available under torque control.</li> <li>• Appears when either one of a Vector control compatible plug-in option or a control terminal option (FR-A8TP) is not installed during machine end orientation control.</li> <li>• Appears when the switch for manufacturer setting of the plug-in option is changed.</li> <li>• Appears when a communication option is connected while <b>Pr.296 Password lock level</b> = "0 or 100".</li> </ul>			
Check point	<ul style="list-style-type: none"> <li>• Check that the AC power supply is not connected to terminal R/L1, S/L2, or T/L3 when the FR-HC2, FR-XC (in common bus regeneration mode), or FR-CV is connected to the inverter while <b>Pr.30</b> = "2".</li> <li>• Check that the plug-in option for torque command setting is connected.</li> <li>• Check that the Vector control plug-in option and the control terminal option (FR-A8TP) are installed correctly.</li> <li>• Check that the <b>Pr.393 Orientation selection</b> and <b>Pr.862 Encoder option selection</b> settings are correct.</li> <li>• Check for the password lock with a setting of <b>Pr.296</b> = "0, 100".</li> </ul>			
Corrective action	<ul style="list-style-type: none"> <li>• Check the <b>Pr.30</b> setting and wiring with the FR-HC2, FR-XC, or FR-CV.</li> <li>• The inverter may be damaged if the AC power supply is connected to terminal R/L1, S/L2, or T/L3 when a high power factor converter is connected. Contact your sales representative.</li> <li>• Check for connection of the plug-in option. Check the <b>Pr.804</b> setting.</li> <li>• Install the Vector control plug-in option and the control terminal option (FR-A8TP) correctly. Set <b>Pr.393</b> and <b>Pr.862</b> correctly. (Refer to <a href="#">page 585</a>.)</li> <li>• Set the switch on the plug-in option, which is for manufacturer setting, back to the initial setting. (Refer to the Instruction Manual of each option.)</li> <li>• To apply the password lock when installing a communication option, set <b>Pr.296</b> ≠ "0, 100". (Refer to <a href="#">page 348</a>.)</li> </ul>			

Operation panel indication	E.OP1 to E.OP3	E. OP 1 to	FR-LU08 indication	Option1 Fault to Option3 Fault
Name	Communication option fault			
Description	<ul style="list-style-type: none"> <li>The inverter output is shut off if a communication line error occurs in the communication option.</li> <li>This function stops the inverter output when a communication line error occurs on the CC-Link IE Field network communication circuit board of the FR-A800-GF.</li> <li>When the FR-A8APR is installed to the inverter and a motor with a resolver is used, the inverter output is shut off if the FR-A8APR fails or the wiring of the resolver is not properly connected.</li> </ul>			
Check point	<ul style="list-style-type: none"> <li>Check for an incorrect option function setting and operation.</li> <li>Check that the plug-in option is plugged into the connector securely.</li> <li>For the FR-A800-GF, check that the CC-Link IE Field Network communication circuit board is securely installed to the connector of the inverter control circuit board.</li> <li>Check for a break in the communication cable.</li> <li>Check that the terminating resistor is fitted properly.</li> <li>Check that the wiring of the resolver is correct. (When the FR-A8APR is used.)</li> </ul>			
Corrective action	<ul style="list-style-type: none"> <li>Check the option function setting, etc.</li> <li>Connect the plug-in option securely.</li> <li>Connect the CC-Link IE Field Network communication circuit board of the FR-A800-GF securely.</li> <li>Check the connection of communication cable.</li> <li>Check the wiring of the resolver (when the FR-A8APR is used).</li> <li>If the fault occurs again when the inverter is reset, contact your sales representative.</li> </ul>			

Operation panel indication	E.16 to E.20	E. 16 to E. 20	FR-LU08 indication	Fault 16 to Fault 20
Name	User definition error by the PLC function			
Description	<p>The protective function is activated by setting "16 to 20" in the special register SD1214 for the PLC function. The inverter output is shut off when the protective function is activated.</p> <p>The protective function is activated when the PLC function is enabled. This protective function is not available in the initial setting (Pr.414 = "0").</p> <p>Any character string can be displayed on FR-LU08 or FR-PU07 by sequence programs.</p>			
Check point	<ul style="list-style-type: none"> <li>Check if "16 to 20" is set in the special register SD1214.</li> </ul>			
Corrective action	<ul style="list-style-type: none"> <li>Set a value other than "16 to 20" in the special register SD1214.</li> </ul>			

Operation panel indication	E.PE	E. PE	FR-LU08 indication	Corrupt Memory
Name	Parameter storage device fault (control circuit board)			
Description	The inverter output is shut off if a fault occurs in the parameter stored. (EEPROM failure)			
Check point	Check for too many number of parameter write times.			
Corrective action	<p>Contact your sales representative.</p> <p>Set "1" in <b>Pr.342 Communication EEPROM write selection</b> (write to RAM) for the operation which requires frequent parameter writing via communication, etc. Note that writing to RAM goes back to the initial status at power OFF.</p>			

Operation panel indication	E.PUE	E. PUE	FR-LU08 indication	PU disconnection
Name	PU disconnection			
Description	<ul style="list-style-type: none"> <li>The inverter output is shut off if communication between the inverter and PU is suspended, e.g. the operation panel or parameter unit is disconnected, when the disconnected PU disconnection function is valid in <b>Pr.75 Reset selection/disconnected PU detection/PU stop selection</b>.</li> <li>The inverter output is shut off if communication errors occurred consecutively for more than permissible number of retries when <b>Pr.121 PU communication retry count</b> ≠ "9999" during the RS-485 communication via the PU connector.</li> <li>The inverter output is shut off if communication is broken within the period of time set in <b>Pr.122 PU communication check time interval</b> during the RS-485 communication via the PU connector.</li> </ul>			
Check point	<ul style="list-style-type: none"> <li>Check that the operation panel or the parameter unit is connected properly.</li> <li>Check the <b>Pr.75</b> setting.</li> </ul>			
Corrective action	Fit the operation panel or the parameter unit securely.			

Operation panel indication	E.RET	E. RET	FR-LU08 indication	Retry count excess
Name	Retry count excess			
Description	The inverter output is shut off if the operation cannot be resumed properly within the number of retries set in <b>Pr.67 Number of retries at fault occurrence</b> . This function is available when <b>Pr.67</b> is set. This protective function is not available in the initial setting ( <b>Pr.67</b> = "0").			
Check point	Find the cause of the fault occurrence.			
Corrective action	Eliminate the cause of the fault preceding this fault indication.			

Operation panel indication	E.PE2	E. PE2	FR-LU08 indication	PR storage alarm
Name	Parameter storage device fault (main circuit board)			
Description	The inverter output is shut off if a fault occurs in the parameter stored. (EEPROM failure)			
Check point	-----			
Corrective action	Contact your sales representative.			

Operation panel indication	E.CPU	E. CPU	FR-LU08 indication	CPU Fault
	E. 5	E. 5		Fault 5
	E. 6	E. 6		Fault 6
	E. 7	E. 7		Fault 7
Name	CPU fault			
Description	The inverter output is shut off if the communication fault of the built-in CPU occurs.			
Check point	Check for devices producing excess electrical noises around the inverter.			
Corrective action	<ul style="list-style-type: none"> <li>Take measures against noises if there are devices producing excess electrical noises around the inverter.</li> <li>Contact your sales representative.</li> </ul>			

Operation panel indication	E.CTE	E. CTE	FR-LU08 indication	Circuit fault
Name	Operation panel power supply short circuit/RS-485 terminals power supply short circuit			
Description	<ul style="list-style-type: none"> <li>When the power supply for the operation panel (PU connector) is shorted, the power output is shutdown and the inverter output is shut off. The use of the operation panel (parameter unit) and the RS-485 communication via the PU connector are disabled. To reset, enter the RES signal from the terminal, reset through communication via the RS-485 terminals, or switch power OFF then ON again.</li> <li>When the power supply for the RS-485 terminals are short circuited, this function shuts off the power output. At this time, communication from the RS-485 terminals cannot be made. To reset, use  on the operation panel, enter the RES signal, or switch power OFF then ON again.</li> </ul>			
Check point	<ul style="list-style-type: none"> <li>Check that the PU connector cable is not shorted.</li> <li>Check that the RS-485 terminals are connected correctly.</li> </ul>			
Corrective action	<ul style="list-style-type: none"> <li>Check PU and the cable.</li> <li>Check the connection of the RS-485 terminals.</li> </ul>			

Operation panel indication	E.P24	E. P24	FR-LU08 indication	24 VDC power fault
Name	24 VDC power fault			
Description	<ul style="list-style-type: none"> <li>When the 24 VDC power output from the PC terminal is shorted, this function shuts off the power output. At this time, all external contact inputs switch OFF. The inverter cannot be reset by entering the RES signal. To reset it, use the operation panel, or switch power OFF, then ON again.</li> </ul>			
Check point	<ul style="list-style-type: none"> <li>Check for a short circuit in the PC terminal output.</li> <li>Check that the 24 V external power supply voltage is correct.</li> </ul>			
Corrective action	<ul style="list-style-type: none"> <li>Repair the short-circuited portion.</li> <li>Supply the power at 24 V. (If the power with insufficient voltage is supplied to the 24 V input circuit for a long time, the inverter internal circuit may heat up. Although it will not damage the inverter, supply power at the correct voltage.)</li> </ul>			

Operation panel indication	E.CDO	E. CDO	FR-LU08 indication	OC detect level
Name	Abnormal output current detection			
Description	The inverter output is shut off if the output current exceeds the <b>Pr.150 Output current detection level</b> setting. This functions is available when "1" is set in <b>Pr.167 Output current detection operation selection</b> . When the initial value ( <b>Pr.167</b> = "0") is set, this protective function is not available.			
Check point	Check the settings of <b>Pr.150, Pr.151 Output current detection signal delay time, Pr.166 Output current detection signal retention time, and Pr.167</b> . (Refer to <a href="#">page 487</a> .)			

Operation panel indication	E.IOH	E. IOH	FR-LU08 indication	Inrush overheat
Name	Inrush current limit circuit fault (Standard models and IP55 compatible models only)			
Description	The inverter output is shut off when the resistor of the inrush current limit circuit is overheated. The inrush current limit circuit is faulty.			
Check point	<ul style="list-style-type: none"> <li>• Check that frequent power ON/OFF is not repeated.</li> <li>• Check if the input side fuse (5A) in the power supply circuit of the inrush current limit circuit contactor (FR-A840-03250(110K) or higher) is blown.</li> <li>• Check that the power supply circuit of inrush current limit circuit contactor is not damaged.</li> </ul>			
Corrective action	Configure a circuit where frequent power ON/OFF is not repeated. If the problem still persists after taking the above measure, contact your sales representative.			

Operation panel indication	E.SER	E. SER	FR-LU08 indication	VFD Comm error
Name	Communication fault (inverter)			
Description	The inverter output is shut off when communication error occurs consecutively for the permissible number of retries or more when <b>Pr.335 RS-485 communication retry count</b> ≠ "9999" during RS-485 communication through the RS-485 terminals. The inverter output is also shut off if communication is broken for the period of time set in <b>Pr.336 RS-485 communication check time interval</b> .			
Check point	Check the RS-485 terminal wiring.			
Corrective action	Perform wiring of the RS-485 terminals properly.			

Operation panel indication	E.AIE	E. AIE	FR-LU08 indication	Analog input fault
Name	Analog input fault			
Description	The inverter output is shut off when a 30 mA or higher current or a 7.5 V or higher voltage is input to terminal 2 while the current input is selected by <b>Pr.73 Analog input selection</b> , or to terminal 4 while the current input is selected by <b>Pr.267 Terminal 4 input selection</b> .			
Check point	Check the <b>Pr.73, Pr.267</b> , and the voltage/current input switch settings. (Refer to <a href="#">page 496</a> .)			
Corrective action	Either give a current less than 30 mA, or set <b>Pr.73, Pr.267</b> , and the voltage/current input switch to the voltage input and input a voltage.			

Operation panel indication	E.USB	E. USB	FR-LU08 indication	USB comm error
Name	USB communication fault			
Description	The inverter output is shut off when the communication is cut off for the time set in <b>Pr.548 USB communication check time interval</b> .			
Check point	<ul style="list-style-type: none"> <li>• Check that the USB communication cable is connected securely.</li> </ul>			
Corrective action	<ul style="list-style-type: none"> <li>• Check the <b>Pr.548</b> setting.</li> <li>• Connect the USB communication cable securely.</li> <li>• Increase the <b>Pr.548</b> setting or set "9999." (Refer to <a href="#">page 701</a>.)</li> </ul>			



Operation panel indication	E.SAF	E. SAF	FR-LU08 indication	Safety circuit fault
Name	Safety circuit fault			
Description	<ul style="list-style-type: none"> <li>The inverter output is shut off when a safety circuit fault occurs.</li> <li>The inverter output is shut off if the either of the wire between S1 and SIC or S2 and SIC becomes non-conductive while using the safety stop function.</li> <li>When the safety stop function is not used, the inverter output is shut off when the shorting wire between terminals S1 and PC or across S2 and PC is disconnected.</li> <li>Settings of the switches (SW3 and SW4) for manufacturer setting may have been changed from the initial settings.</li> </ul>			
Check point	<ul style="list-style-type: none"> <li>Check that the safety relay module or the connection has no fault when using the safety stop function.</li> <li>Check if the shorting wire between S1 and PC or between S2 and PC is disconnected when not using the safety stop function.</li> <li>Check that the initial position of each switch was not changed.</li> </ul>			
Corrective action	<ul style="list-style-type: none"> <li>When using the safety stop function, check that wiring of terminal S1, S2 and SIC is correct and the safety stop input signal source such as a safety relay module is operating properly. Refer to the Safety Stop Function Instruction Manual for causes and countermeasures. (Contact your sales representative for the manual.)</li> <li>When the safety stop function is not used, short across terminals S1 and PC and across S2 and PC with shorting wires. (Refer to <a href="#">page 82</a>.)</li> <li>Set each manufacturer setting switch to the initial position (OFF). (Refer to <a href="#">page 19</a> for the positions of the switches.)</li> </ul>			

Operation panel indication	E.PBT	E. PBT	FR-LU08 indication	PBT fault
	E.13	E. 13		Internal circuit fault
Name	Internal circuit fault			
Description	The inverter output is shut off when an internal circuit fault occurs.			
Corrective action	Contact your sales representative.			

Operation panel indication	E.OS	E. OS	FR-LU08 indication	Overspeed occurrence
Name	Overspeed occurrence			
Description	The inverter output is shut off when the motor speed exceeds the <b>Pr.374 Overspeed detection level</b> under encoder feedback control, Real sensorless vector control, Vector control, and PM sensorless vector control. This protective function is not available in the initial status.			
Check point	<ul style="list-style-type: none"> <li>Check that the <b>Pr.374</b> setting is correct.</li> <li>Check that the setting of <b>Pr.369 (Pr.851) Number of encoder pulses</b> does not differ from the actual number of encoder pulses. (Under encoder feedback control or vector control)</li> <li>Check that the motor temperature is not increased under Real sensorless vector control. (The motor constant may vary due to increase in the motor temperature.)</li> </ul>			
Corrective action	<ul style="list-style-type: none"> <li>Set <b>Pr.374</b> correctly.</li> <li>Set <b>Pr.369 (Pr.851)</b> correctly. (Under encoder feedback control or vector control)</li> <li>When the motor temperature increases, enable the online auto tuning at startup (set <b>Pr.95 (Pr.574) = "1"</b>) (under Real sensorless vector control). To perform the online auto tuning at startup for a lift, use of the Start-time tuning start external input (X28) signal is recommended. (Refer to <a href="#">page 558</a>.)</li> </ul>			

Operation panel indication	E.OSD Vector	E. OSD	FR-LU08 indication	Spd deviation fault
Name	Speed deviation excess detection			
Description	<ul style="list-style-type: none"> <li>The inverter output is shut off if the motor speed is increased or decreased under the influence of the load etc. during Vector control with <b>Pr.285 Overspeed detection frequency</b> set and cannot be controlled in accordance with the speed command value.</li> <li>If the motor is accelerated against the stop command accidentally, the deceleration check function (<b>Pr.690</b>) is activated to stop the inverter output.</li> </ul>			
Check point	<ul style="list-style-type: none"> <li>Check that the settings of <b>Pr.285</b> and <b>Pr.853 Speed deviation time</b> are correct.</li> <li>Check for sudden load change.</li> <li>Check that the setting of <b>Pr.369 (Pr.851) Number of encoder pulses</b> does not differ from the actual number of encoder pulses.</li> </ul>			
Corrective action	<ul style="list-style-type: none"> <li>Set <b>Pr.285</b> and <b>Pr.853</b> correctly.</li> <li>Keep the load stable.</li> <li>Set <b>Pr.369 (Pr.851)</b> correctly.</li> </ul>			



Operation panel indication	E.ECT	E. ECT	FR-LU08 indication	Encoder signal loss
Name	Signal loss detection			
Description	The inverter output is shut off when the encoder signal is shut off under orientation control, encoder feedback control or vector control. This protective function is not available in the initial status.			
Check point	<ul style="list-style-type: none"> <li>• Check for the encoder signal loss.</li> <li>• Check that the encoder specifications are correct.</li> <li>• Check for a loose connector.</li> <li>• Check that the switch setting of a Vector control compatible option is correct.</li> <li>• Check that the power is supplied to the encoder. Alternatively, check that the power is not supplied to the encoder later than the inverter.</li> <li>• Check that the voltage of the power supplied to the encoder is the same as the encoder output voltage.</li> </ul>			
Corrective action	<ul style="list-style-type: none"> <li>• Remedy the signal loss.</li> <li>• Use an encoder that meets the specifications.</li> <li>• Make connection securely.</li> <li>• Make a switch setting of a Vector control compatible option correctly. (Refer to <a href="#">page 88</a>.)</li> <li>• Supply the power to the encoder. Or supply the power to the encoder at the same time when the power is supplied to the inverter.</li> </ul> <p>If the power is supplied to the encoder after sent to the inverter, check that the encoder signal is properly sent and set "0 (initial value)" in <b>Pr.376 Encoder signal loss detection enable/disable selection</b> to disable signal loss detection.</p> <ul style="list-style-type: none"> <li>• Make the voltage of the power supplied to the encoder the same as the encoder output voltage.</li> </ul>			

Operation panel indication	E.OD Vector	E. Od	FR-LU08 indication	Position fault
Name	Excessive position fault			
Description	The inverter output is shut off when the difference between the position command and position feedback exceeds the setting of <b>Pr.427 Excessive level error</b> during position control. This protective function is not available in the initial status.			
Check point	<ul style="list-style-type: none"> <li>• Check that the position detecting encoder mounting orientation matches the parameter.</li> <li>• Check that the load is not large.</li> <li>• Check that the settings of <b>Pr.427</b> and <b>Pr.369 (Pr.851) Number of encoder pulses</b> are correct.</li> </ul>			
Corrective action	<ul style="list-style-type: none"> <li>• Check the parameters.</li> <li>• Reduce the load.</li> <li>• Set <b>Pr.427</b> and <b>Pr.369 (Pr.851)</b> correctly.</li> </ul>			

Operation panel indication	E.ECA Vector	E. ECA	FR-LU08 indication	ENC direction fault
Name	Encoder signal loss for orientation			
Description	The inverter output is shut off when the machine end encoder signal is shut off during machine end orientation control under Vector control. This protective function is not available in the initial status.			
Check point	<ul style="list-style-type: none"> <li>• Check for the encoder signal loss.</li> <li>• Check that the encoder specifications are correct.</li> <li>• Check for a loose connector.</li> <li>• Check that the switch setting of a Vector control compatible option is correct.</li> <li>• Check that the power is supplied to the encoder. Alternatively, check that the power is not supplied to the encoder later than the inverter.</li> <li>• Check that the voltage of the power supplied to the encoder is the same as the encoder output voltage.</li> </ul>			
Corrective action	<ul style="list-style-type: none"> <li>• Remedy the signal loss.</li> <li>• Use an encoder that meets the specifications.</li> <li>• Make connection securely.</li> <li>• Make a switch setting of a Vector control compatible option correctly. (Refer to <a href="#">page 88</a>.)</li> <li>• Supply the power to the encoder. Or supply the power to the encoder at the same time when the power is supplied to the inverter.</li> </ul> <p>If the power is supplied to the encoder after sent to the inverter, check that the encoder signal is properly sent and set "0 (initial value)" in <b>Pr.376 Encoder signal loss detection enable/disable selection</b> to disable signal loss detection.</p> <ul style="list-style-type: none"> <li>• Make the voltage of the power supplied to the encoder the same as the encoder output voltage.</li> </ul>			

Operation panel indication	E.MB1 to 7	E. Mb 1 <sup>to</sup> E. Mb 7	FR-LU08 indication	E.MB1 Fault to E.MB7 Fault
Name	Brake sequence fault			
Description	The inverter output is shut off when a sequence error occurs during use of the brake sequence function ( <b>Pr.278 to Pr.285</b> ). This protective function is not available in the initial status. (The brake sequence function is invalid.) (For details on fault records, refer to <a href="#">page 572</a> .)			
Check point	Find the cause of the fault occurrence.			
Corrective action	Check the set parameters and perform wiring properly.			

Operation panel indication	E.EP Vector	E. EP	FR-LU08 indication	Encoder phase fault
Name	Encoder phase fault			
Description	The inverter output is shut off when the rotation command of the inverter differs from the actual motor rotation direction detected from the encoder during offline auto tuning. This protective function is not available in the initial status.			
Check point	<ul style="list-style-type: none"> <li>• Check for mis-wiring of the encoder cable.</li> <li>• Check if the <b>Pr.359 (Pr.852) Encoder rotation direction</b> setting is incorrect.</li> </ul>			
Corrective action	<ul style="list-style-type: none"> <li>• Perform connection and wiring securely.</li> <li>• Change the <b>Pr.359 (Pr.852)</b> setting.</li> </ul>			

Operation panel indication	E.MP Vector	E. MP	FR-LU08 indication	MagnetPole Pos Fault
Name	Magnetic pole position unknown			
Description	When the offset value between the PM motor home magnetic pole position and the home position of the encoder (position detector) is unknown, the protective circuit is activated to stop the inverter output.			
Check point	<ul style="list-style-type: none"> <li>• Check that the encoder position tuning was performed.</li> <li>• Check that the encoder position tuning ended properly. When <b>Pr.1105 (Pr.887) Encoder magnetic pole position offset = "9999"</b>, the encoder position tuning does not end properly.</li> </ul>			
Corrective action	<ul style="list-style-type: none"> <li>• Perform encoder position tuning with <b>Pr.373 (Pr.871) Encoder position tuning setting/status</b>. (Refer to <a href="#">page 542</a>.)</li> <li>• Remove the cause of the tuning error, and perform tuning again. (Refer to <a href="#">page 542</a>.)</li> </ul>			

Operation panel indication	E.EF	E. EF	FR-LU08 indication	E.EF
Name	External fault during output operation			
Description	When the X32 signal turns OFF (the contact opens) due to an external fault or other factor, the inverter output is shut off. This function is available when "32" is set in any of <b>Pr.178 to Pr.189 (Input terminal function selection)</b> . This protective function is not available in the initial status (X32 signal is not assigned).			
Check point	<ul style="list-style-type: none"> <li>• Check that the X32 signal is OFF.</li> </ul>			
Corrective action	<ul style="list-style-type: none"> <li>• Make sure that there is no problem in starting operation, and turn ON the X32 signal.</li> </ul>			

Operation panel indication	E.IAH	E. IAH	FR-LU08 indication	Abnormal Intl Temp
Name	Abnormal internal temperature (IP55 compatible models only)			
Description	The inverter output is shut off when the inverter internal temperature reaches the specified value or higher.			
Check point	<ul style="list-style-type: none"> <li>• Check for too high surrounding air temperature.</li> <li>• Check if the internal air circulation fan or the cooling fan stops due to a fault.</li> </ul>			
Corrective action	<ul style="list-style-type: none"> <li>• Install an inverter suitable for the installation environment. (Refer to the Instruction Manual (Hardware).)</li> <li>• Replace the internal air circulation fan or the cooling fan.</li> </ul>			

Operation panel indication	E.LCI	E. LCI	FR-LU08 indication	4 mA input fault
Name	4 mA input fault			
Description	The inverter output is shut off when the analog input current is 2 mA or less for the time set in <b>Pr.778 4 mA input check filter</b> . This function is available when <b>Pr.573 4 mA input check selection = "2 or 3"</b> . (Refer to <a href="#">page 517</a> .) This protective function is not available in the initial status.			
Check point	<ul style="list-style-type: none"> <li>• Check for a break in the wiring for the analog current input.</li> <li>• Check that the <b>Pr.778</b> setting is not too short.</li> </ul>			
Corrective action	<ul style="list-style-type: none"> <li>• Check the wiring for the analog current input.</li> <li>• Set the <b>Pr.778</b> setting larger.</li> </ul>			

Operation panel indication	E.PCH	E. PCH	FR-LU08 indication	Pre-charge fault
Name	Pre-charge fault			
Description	The inverter output is shut off when the pre-charge time exceeds <b>Pr.764 Pre-charge time limit</b> . The inverter output is shut off when the measured value exceeds <b>Pr.763 Pre-charge upper detection level</b> during pre-charging. This function is available when <b>Pr.764</b> and <b>Pr.763</b> are set (refer to <a href="#">page 618</a> ). This protective function is not available in the initial status.			
Check point	<ul style="list-style-type: none"> <li>• Check that the <b>Pr.764</b> setting is not too short.</li> <li>• Check that the <b>Pr.763</b> setting is not too small.</li> <li>• Check that the <b>Pr.127 PID control automatic switchover frequency</b> setting is not too low.</li> <li>• Check for a break in the connection to the pump.</li> </ul>			
Corrective action	<ul style="list-style-type: none"> <li>• Set the <b>Pr.764</b> setting longer.</li> <li>• Set the <b>Pr.763</b> setting larger.</li> <li>• Set the <b>Pr.127</b> setting higher.</li> <li>• Check the connection to the pump.</li> </ul>			

Operation panel indication	E.PID	E. PId	FR-LU08 indication	PID signal fault
Name	PID signal fault			
Description	The inverter output is shut off if the measured value exceeds the PID upper limit or PID lower limit parameter setting, or the absolute deviation value exceeds the PID deviation parameter setting during PID control. Set this function in <b>Pr.131 PID upper limit</b> , <b>Pr.132 PID lower limit</b> , <b>Pr.553 PID deviation limit</b> , and <b>Pr.554 PID signal operation selection</b> . (Refer to <a href="#">page 601</a> .) This protective function is not available in the initial status.			
Check point	<ul style="list-style-type: none"> <li>• Check the meter for a failure or break.</li> <li>• Check that the parameter settings are correct.</li> </ul>			
Corrective action	<ul style="list-style-type: none"> <li>• Check that the meter has no failure or break.</li> <li>• Set the parameters correctly.</li> </ul>			

Operation panel indication	E. 1 to E. 3	E. 1 to E. 3	FR-LU08 indication	Fault 1 to Fault 3
Name	Option fault			
Description	<ul style="list-style-type: none"> <li>• The inverter output is shut off when a contact fault is found between the inverter and the plug-in option, or when the communication option is not connected to the connector 1.</li> <li>• For the FR-A800-GF, the inverter output is shut off when a connector contact fault or the like occurs between the CC-Link IE Field network communication circuit board and the inverter control circuit board.</li> <li>• The inverter output is shut off when encoder feedback control is performed while 10 poles or more is set in <b>Pr.144 Speed setting switchover</b>.</li> <li>• Appears when the switch for manufacturer setting of the plug-in option is changed.</li> </ul>			
Check point	<ul style="list-style-type: none"> <li>• Check that the plug-in option is plugged into the connector securely. (1 to 3 indicate connector numbers for connection of options.)</li> <li>• For the FR-A800-GF, check that the CC-Link IE Field Network communication circuit board is securely installed to the connector of the inverter control circuit board.</li> <li>• Check for excessive noise around the inverter.</li> <li>• Check if the communication option is connected to the connector 2 or 3.</li> <li>• For encoder feedback control operation, check that the number of motor poles is correct.</li> </ul>			
Corrective action	<ul style="list-style-type: none"> <li>• Connect the plug-in option securely.</li> <li>• Connect the CC-Link IE Field Network communication circuit board of the FR-A800-GF securely.</li> <li>• Take precautions against noise if there are devices producing excessive electrical noise around the inverter. If the problem still persists after taking the above measure, contact your sales representative.</li> <li>• Connect the communication option to the connector 1.</li> <li>• For encoder feedback control operation, use a motor with 8 poles or less.</li> <li>• Set the switch on the plug-in option, which is for manufacturer setting, back to the initial setting. (Refer to the Instruction Manual of each option.)</li> </ul>			

Operation panel indication	E.11 Sensorless	E. 11	FR-LU08 indication	Opst rot dtct fault
Name	Opposite rotation deceleration fault			
Description	The speed may not decelerate during low speed operation if the rotation direction of the speed command and the estimated speed differ when the rotation is changing from forward to reverse or from reverse to forward during torque control under Real sensorless vector control. The inverter output is shut off when overload occurs due to the un-switched rotation direction. This protective function is not available in the initial status (V/F control). (This function is only available under Real sensorless vector control.)			
Check point	<ul style="list-style-type: none"> <li>Check that the rotation direction is not switched from forward to reverse rotation (or from reverse to forward) during torque control under Real sensorless vector control.</li> </ul>			
Corrective action	<ul style="list-style-type: none"> <li>Prevent the motor from switching the rotation direction from forward to reverse (or from reverse to forward) during torque control under Real sensorless vector control.</li> <li>Contact your sales representative.</li> </ul>			

## ◆ Others

Indicate the status of the inverter. It is not a fault.

Operation panel indication	E.0	E. 0	FR-LU08 indication	No faults
Name	No fault history			
Description	Appears when no fault records are stored. (Appears when the fault history is cleared after the protective function has been activated.)			

Operation panel indication	EV	EV	FR-LU08 indication	—
Name	24 V external power supply operation			
Description	Blinks when the main circuit power supply is off and the 24 V external power supply is being input.			
Check point	<ul style="list-style-type: none"> <li>Power is supplied from a 24 V external power supply.</li> </ul>			
Corrective action	<ul style="list-style-type: none"> <li>Turning ON the power supply (main circuit) of the inverter clears the indication.</li> <li>If the indication is still displayed after turning ON of the power supply (main circuit) of the inverter, the power supply voltage may be low, or the jumper between terminals P/+ and P1 may be disconnected.</li> </ul>			

Operation panel indication	RD	Rd	FR-LU08 indication	Rd
Name	Backup in progress			
Description	The GOT is used for backing up inverter parameters and the data used in the PLC function of inverter. (Refer to <a href="#">page 702.</a> )			

Operation panel indication	WR	WR	FR-LU08 indication	WR
Name	Restoration in progress			
Description	The backup data stored in the GOT is used to restore the data in the inverter. (Refer to <a href="#">page 702.</a> )			

### NOTE

- If protective functions with indication of "Fault" on the FR-LU08 or FR-PU07 are activated, "ERR" appears in the fault history of the FR-LU08 or FR-PU07.
- If faults other than the above appear, contact your sales representative.

## 6.6 Check first when you have a trouble





For Real sensorless vector control and Vector control, also refer to the troubleshooting on [page 261](#) (speed control), [page 295](#) (torque control), and [page 329](#) (position control).

### Point

- If the cause is still unknown after every check, it is recommended to initialize the parameters, set the required parameter values and check again.

### 6.6.1 Motor does not start

Check point	Possible cause	Countermeasure	Refer to page
Main circuit	An appropriate power supply voltage is not applied. (The operation panel display is not operating.)	Power on a molded case circuit breaker (MCCB), an earth leakage circuit breaker (ELB), or a magnetic contactor (MC).	—
		Check for the decreased input voltage, input phase loss, and wiring.	—
		If only the control power is ON when using a separate power source for the control circuit, turn ON the main circuit power.	77
	The motor is not connected properly.	Check the wiring between the inverter and the motor. If the electronic bypass function is active, check the wiring of the magnetic contactor (MC) between the inverter and the motor.	55
The jumper across P/+ to P1 is disconnected. A DC reactor (FR-HEL) is not connected.	Securely fit a jumper across P/+ and P1. When using a DC reactor (FR-HEL), remove the jumper across P/+ to P1, and then connect the DC reactor. Connect the DC reactor securely when required according to the capacity.	55, 109	

Check point	Possible cause	Countermeasure	Refer to page
Input signal	A start signal is not input.	Check the start command source, and input a start signal. PU operation mode:  /  External operation mode: STF/STR signal	393
	Both the forward and reverse rotation start signals (STF, STR) are input simultaneously.	Turn ON only one of the forward and reverse rotation start signals (STF or STR). When the STF and STR signals are turned ON simultaneously in the initial setting, a stop command is given.	68
	Frequency command is zero. (The [FWD] or [REV] LED indicator on the operation panel is blinking.)	Check the frequency command source and input a frequency command.	393
	The AU signal is not ON when terminal 4 is used for frequency setting. (The [FWD] or [REV] LED indicator on the operation panel is blinking.)	Turn ON the AU signal. Turning ON the AU signal activates terminal 4 input.	496
	The Output stop (MRS) signal or Inverter reset (RES) signal is ON. (The [FWD] or [REV] LED indicator on the operation panel is blinking.)	Turn the MRS or RES signal OFF. The inverter starts the operation with a given start command and a frequency command after turning OFF the MRS or RES signal. Before turning OFF, ensure the safety.	68
	The CS signal is OFF while the automatic restart after instantaneous power failure function is selected ( <b>Pr.57 Restart coasting time</b> ≠ 9999). (The [FWD] or [REV] LED indicator on the operation panel is blinking.)	Turn ON the Selection of automatic restart after instantaneous power failure / flying start (CS) signal. When the CS signal is assigned to an input terminal, automatic restart operation is enabled when the CS signal is turned ON.	628
	The jumper connector for selecting sink logic or source logic is incorrectly installed. (The [FWD] or [REV] LED indicator on the operation panel is blinking.)	Check that the control logic switchover jumper connector is correctly installed. If it is not installed correctly, the input signal is not recognized.	72
	The wiring of the encoder is incorrect. (Under encoder feedback control or vector control)	Check the wiring of the encoder.	91
	The voltage/current input switch is not correctly set for the analog input signal (0 to 5 V, 0 to 10 V, or 4 to 20 mA). (The [FWD] or [REV] LED indicator on the operation panel is blinking.)	Set <b>Pr.73 Analog input selection</b> , <b>Pr.267 Terminal 4 input selection</b> , and a voltage/current input switch correctly, then input an analog signal in accordance with the setting.	496
	The  key was pressed. (The operation panel indication is "PS" (PS).)	During the External operation mode, check the method of restarting from a  input stop from PU.	338, 783
For the separated converter type, terminals RDA and SE of the converter unit are not connected to terminals MRS (X10 signal) and SD (PC for source logic) of the inverter respectively.	Check for secure wiring connections.	Refer to the Instruction Manual (Hardware) of the FR-A802.	

Check point	Possible cause	Countermeasure	Refer to page
Parameter setting	Two-wire or three-wire type connection is incorrect.	Check the connection. Use the Start self-holding selection (STP (STOP)) signal when the three-wire type is used.	722
	Under V/F control, <b>Pr.0 Torque boost</b> setting is not appropriate.	Increase the <b>Pr.0</b> setting by 0.5% increments while observing the rotation of a motor. If that makes no difference, decrease the setting.	706
	<b>Pr.78 Reverse rotation prevention selection</b> is set.	Check the <b>Pr.78</b> setting. Set <b>Pr.78</b> when you want to limit the motor rotation to only one direction.	406
	The <b>Pr.79 Operation mode selection</b> setting is incorrect.	Select the operation mode suitable for the input methods of the start command and frequency command.	389
	The bias and gain ( <b>the calibration parameter C2 to C7</b> ) settings are not appropriate.	Check the bias and gain ( <b>the calibration parameter C2 to C7</b> ) settings.	505
	The <b>Pr.13 Starting frequency</b> setting is greater than the set frequency.	Set the frequency higher than the one set in <b>Pr.13</b> . The inverter does not start if the frequency setting signal has a value lower than that of <b>Pr.13</b> .	381, 367
	Zero is set in frequency settings (such as for multi-speed operation). Especially, <b>Pr.1 Maximum frequency</b> is zero.	Set the frequency command according to the application. Set <b>Pr.1</b> higher than the actual frequency used.	411, 428
	<b>Pr.15 Jog frequency</b> is lower than <b>Pr.13 Starting frequency</b> for JOG operation.	The <b>Pr.15</b> setting should be equal to or higher than the <b>Pr.13</b> setting.	381, 382, 410
	The <b>Pr.359 (Pr.852) Encoder rotation direction</b> setting is incorrect under encoder feedback control or under vector control.	If the REV indicator on the operation panel is ON even though the forward-rotation command is given, set <b>Pr.359 (Pr.852) = "1"</b> .	94, 736
	When a Vector control option is used, the option to be used and parameter settings do not match.	Correctly set <b>Pr.862 Encoder option selection</b> according to the option to be used.	226
	Operation mode and a writing device do not correspond.	Check <b>Pr.79 Operation mode selection</b> , <b>Pr.338 Communication operation command source</b> , <b>Pr.339 Communication speed command source</b> , <b>Pr.550 NET mode operation command source selection</b> and <b>Pr.551 PU mode operation command source selection</b> , and select an operation mode suitable for the purpose.	389, 400
	The start signal operation selection is set by <b>Pr.250 Stop selection</b>	Check the <b>Pr.250</b> setting and the connection of the STF and STR signals.	722
	The motor has decelerated to a stop when the power failure time deceleration-to-stop function is selected.	When power is restored, ensure the safety, and turn OFF the start signal once, then turn ON again to restart. When <b>Pr.261 Power failure stop selection = "2 or 12"</b> , the motor automatically restarts after the power is restored.	642
	Auto tuning is being performed.	When offline auto tuning ends, press the  key of the operation panel for the PU operation. For the External operation, turn OFF the start signal (STF or STR). This operation resets the offline auto tuning, and the PU's monitor display returns to the normal indication. (Without this operation, next operation cannot be started.)	532, 542, 551, 638
	The automatic restart after instantaneous power failure function or power failure stop function has been activated. (Performing overload operation during input phase loss may cause voltage insufficiency, and that may result in detection of power failure.)	Set <b>Pr.872 Input phase loss protection selection = "1"</b> (input phase failure protection active). Disable the automatic restart after instantaneous power failure function and power failure stop function. Reduce the load. Increase the acceleration time if the function was activated during acceleration.	426, 628, 635, 642
	The motor test operation is selected under Vector control or PM sensorless vector control.	Check the <b>Pr.800 Control method selection</b> setting.	221
When the FR-HC2, FR-XC, FR-CV, or FR-CC2 is used, the input logic setting of the X10 signal is incorrect.	Set <b>Pr.599 = "0"</b> (initial value for standard models and IP55 compatible models) to use the X10 signal with the NO contact input specification, and <b>Pr.599 = "1"</b> (initial value for separated converter types) to use the X10 signal with the NC contact input specification.	724	
Load	Load is too heavy.	Reduce the load.	—
	The shaft is locked.	Inspect the machine (motor).	—



## 6.6.2 Motor or machine is making abnormal acoustic noise

Check point	Possible cause	Countermeasure	Refer to page
<b>Input signal</b>	Disturbance due to EMI when the frequency or torque command is given through analog input terminal 1, 2, or 4.	Take countermeasures against EMI.	116
<b>Parameter setting</b>		Increase the <b>Pr.74 Input filter time constant</b> setting if steady operation cannot be performed due to EMI.	503
<b>Parameter setting</b>	No carrier frequency noises (metallic noises) are generated.	In the initial setting, <b>Pr.240 Soft-PWM operation selection</b> is enabled to change motor noise to an unoffending complex tone. Therefore, no carrier frequency noises (metallic noises) are generated. Set <b>Pr.240</b> = "0" to disable this function.	356
	The motor noise increases due to activation of the carrier frequency automatic reduction function when the motor is driven overloaded.	Reduce the load. Disable the automatic reduction function by setting <b>Pr.260 PWM frequency automatic switchover</b> = "0". (As the load remains excessive, overload may cause a protective function E.THT.)	356
	Resonance occurs. (Output frequency)	Set <b>Pr.31 to Pr.36</b> , and <b>Pr.552</b> (frequency jump). When it is desired to avoid resonance attributable to the natural frequency of a mechanical system, these parameters allow resonant frequencies to be jumped.	429
	Resonance occurs. (Carrier frequency)	Change the <b>Pr.72 PWM frequency selection</b> setting. Changing the PWM carrier frequency produces an effect on avoiding the resonance frequency of a mechanical system or a motor.	356
		Set a notch filter.	271
	Auto tuning is not performed under Advanced magnetic flux vector control, Real sensorless vector control, or Vector control.	Perform offline auto tuning.	532
	Gain adjustment during PID control is insufficient.	To stabilize the measured value, change the proportional band ( <b>Pr.129</b> ) to a larger value, the integral time ( <b>Pr.130</b> ) to a slightly longer time, and the differential time ( <b>Pr.134</b> ) to a slightly shorter time. Check the calibration of set point and measured value.	601
The gain is too high under Real sensorless vector control, Vector control, or PM sensorless vector control.	During speed control, check the setting of <b>Pr.820 Speed control P gain 2</b> .	254	
	During torque control, check the setting of <b>Pr.824 Torque control P gain 2 (current loop proportional gain)</b> .	294	
<b>Others</b>	Mechanical looseness	Adjust machine/equipment so that there is no mechanical looseness.	—
	Contact the motor manufacturer.		
<b>Motor</b>	Operating with output phase loss	Check the motor wiring.	—

## 6.6.3 Inverter generates abnormal noise

Check point	Possible cause	Countermeasure	Refer to page
<b>Fan</b>	The fan cover was not correctly installed when a cooling fan was replaced.	Install the fan cover correctly.	816



## 6.6.4 Motor generates heat abnormally

Check point	Possible cause	Countermeasure	Refer to page
Motor	The motor fan is not working. (Dust is accumulated.)	Clean the motor fan. Improve the environment.	—
	Phase to phase insulation of the motor is insufficient.	Check the insulation of the motor.	—
Main circuit	The inverter output voltage (U, V, W) are unbalanced.	Check the output voltage of the inverter. Check the insulation of the motor.	821
Parameter setting	The <b>Pr.71 Applied motor</b> setting is incorrect.	Check the <b>Pr.71 Applied motor</b> setting.	528
—	Motor current is too large	Refer to "6.6.11 Motor current is too large".	807

## 6.6.5 Motor rotates in the opposite direction

Check point	Possible cause	Countermeasure	Refer to page
Main circuit	The phase sequence of output terminals U, V and W is incorrect.	Connect the output side terminals (terminals U, V, and W) correctly.	55
Input signal	The start signals (STF and STR signals) are connected improperly.	Check the connection. (STF: forward rotation, STR: reverse rotation)	68, 722
	The polarity of the frequency command is negative during the polarity reversible operation set by <b>Pr.73 Analog input selection</b> .	Check the polarity of the frequency command.	496
Input signal, parameter setting	The torque command is negative during torque control under Vector control.	Check the torque command value.	283

## 6.6.6 Speed greatly differs from the setting

Check point	Possible cause	Countermeasure	Refer to page
Input signal	The frequency setting signal is incorrect.	Measure the input signal level.	—
	The input signal lines are affected by external EMI.	Take countermeasures against EMI, such as using shielded wires for input signal lines.	118
Parameter setting	<b>Pr.1 Maximum frequency, Pr.2 Minimum frequency, Pr.18 High speed maximum frequency</b> , and the <b>calibration parameter C2 to C7</b> settings are not appropriate.	Check the settings of <b>Pr.1, Pr.2, and Pr.18</b> .	428
		Check the <b>calibration parameter C2 to C7</b> settings.	505
	<b>Pr.31 to Pr.36, and Pr.552</b> (frequency jump) settings are not appropriate.	Narrow down the range of frequency jump.	429
Load		Reduce the load weight.	—
Parameter setting	The stall prevention (torque limit) function is activated due to a heavy load.	Set <b>Pr.22 Stall prevention operation level (Torque limit level)</b> higher according to the load. (If <b>Pr.22</b> is set too high, an overcurrent trip (E.OC[]) is likely to occur.)	245, 431
Motor		Check the capacities of the inverter and the motor.	—

## 6.6.7 Acceleration/deceleration is not smooth



Check point	Possible cause	Countermeasure	Refer to page
Parameter setting	The acceleration/deceleration time is too short.	Increase the acceleration/deceleration time.	367
	The torque boost ( <b>Pr.0, Pr.46, Pr.112</b> ) setting is not appropriate under V/F control, so the stall prevention function is activated.	Increase/decrease the <b>Pr.0 Torque boost</b> setting value by 0.5% increments so that stall prevention does not occur.	706
	The base frequency does not match the motor characteristics.	Under V/F control, set <b>Pr.3 Base frequency, Pr.47 Second V/F (base frequency)</b> , and Pr.113 Third V/F (base frequency).	707
		Under Vector control, set <b>Pr.84 Rated motor frequency</b> .	221
	Regeneration avoidance operation is performed.	If the frequency becomes unstable during regeneration avoidance operation, decrease the setting of <b>Pr.886 Regeneration avoidance voltage gain</b> .	732
Load		Reduce the load.	—
Parameter setting	The stall prevention (torque limit) function is activated due to a heavy load.	Set <b>Pr.22 Stall prevention operation level (Torque limit level)</b> higher according to the load. (If <b>Pr.22</b> is set too high, an overcurrent trip (E.OC[]) is likely to occur.)	245, 431
Motor		Check the capacities of the inverter and the motor.	—

## 6.6.8 Speed varies during operation

Under Advanced magnetic flux vector control, Real sensorless vector control, Vector control, and encoder feedback control, the output frequency varies between 0 and 2 Hz as the load fluctuates. This is a normal operation and not a fault.

Check point	Possible cause	Countermeasure	Refer to page
Load	The load varies during an operation.	Select Advanced magnetic flux vector control, Real sensorless vector control, Vector control, or encoder feedback control.	221, 736
Input signal	The frequency setting signal is varying.	Check the frequency setting signal.	—
	The frequency setting signal is affected by EMI.	Set filter to the analog input terminal using <b>Pr.74 Input filter time constant</b> , Pr.822 Speed setting filter 1.	503
		Take countermeasures against EMI, such as using shielded wires for input signal lines.	118
	A malfunction is occurring due to the undesirable current generated when the transistor output unit is connected.	Use terminal PC (terminal SD when source logic) as a common terminal to prevent a malfunction caused by undesirable current.	74
	A multi-speed command signal is chattering.	Take countermeasures to suppress chattering.	—
Parameter setting	The feedback signal from the encoder is affected by EMI.	Run the encoder cable away from any EMI source such as the main circuit and power supply voltage. Earth (ground) the shield of the encoder cable to the enclosure using a metal P-clip or U-clip.	91
	Fluctuation of power supply voltage is too large.	Under V/F control, change the <b>Pr.19 Base frequency voltage</b> setting (approximately by 3%).	707
	The <b>Pr.80 Motor capacity</b> and <b>Pr.81 Number of motor poles</b> settings are not appropriate for the motor capacity under Advanced magnetic flux vector control, Real sensorless vector control, Vector control, or PM sensorless vector control.	Check the settings of <b>Pr.80</b> and <b>Pr.81</b> .	221
	The wiring length exceeds 30 m when Advanced magnetic flux vector control, Real sensorless vector control, Vector control, or PM sensorless vector control is selected.	Perform offline auto tuning.	532
	Under V/F control, wiring is too long and a voltage drop occurs.	In the low-speed range, adjust the <b>Pr.0 Torque boost</b> setting by 0.5% increments.	706
		Change the control method to Advanced magnetic flux vector control or Real sensorless vector control.	221
	Hunting occurs by the generated vibration, for example, when structural rigidity of the load is insufficient.	Disable automatic control functions, such as the energy saving operation, fast-response current limit operation, torque limit, regeneration avoidance function, Advanced magnetic flux vector control, Real sensorless vector control, Vector control, encoder feedback control, droop control, stall prevention, online auto tuning, notch filter, and orientation control. For PID control, set smaller values to <b>Pr.129 PID proportional band</b> and <b>Pr.130 PID integral time</b> . Lower the control gain to increase the stability.	—
Change the <b>Pr.72 PWM frequency selection</b> setting.		356	

## 6.6.9 Operation mode is not changed properly

Check point	Possible cause	Countermeasure	Refer to page
<b>Input signal</b>	The start signal (STF or STR) is ON.	Check that the STF and STR signals are OFF. When either is ON, the operation mode cannot be changed.	68, 722
<b>Parameter setting</b>	The <b>Pr.79 Operation mode selection</b> setting is not appropriate.	When the <b>Pr.79</b> is set to "0 (initial value)", the operation mode is the External operation mode at power ON. To switch to the PU operation mode, press the  key on the operation panel (press the  key on the parameter unit (FR-PU07)). At other settings (1 to 4, 6, 7), the operation mode is limited accordingly.	389
	Operation mode and a writing device do not correspond.	Check <b>Pr.79 Operation mode selection</b> , <b>Pr.338 Communication operation command source</b> , <b>Pr.339 Communication speed command source</b> , <b>Pr.550 NET mode operation command source selection</b> and <b>Pr.551 PU mode operation command source selection</b> , and select an operation mode suitable for the purpose.	389, 400

## 6.6.10 Operation panel (FR-DU08) display is not operating

6

Check point	Possible cause	Countermeasure	Refer to page
<b>Main circuit, control circuit</b>	The power is not input.	Input the power.	46
<b>Front cover</b>	The operation panel is not properly connected to the inverter.	Check if the inverter front cover is installed securely.	33

## 6.6.11 The motor current is too large

Check point	Possible cause	Countermeasure	Refer to page
<b>Parameter setting</b>	The torque boost ( <b>Pr.0</b> , <b>Pr.46</b> , <b>Pr.112</b> ) setting is not appropriate under V/F control, so the stall prevention function is activated.	Increase/decrease the <b>Pr.0 Torque boost</b> setting value by 0.5% increments so that stall prevention does not occur.	706
	The V/F pattern is not appropriate when V/F control is performed. ( <b>Pr.3</b> , <b>Pr.14</b> , <b>Pr.19</b> )	Set the rated frequency of the motor to <b>Pr.3 Base frequency</b> . Use <b>Pr.19 Base frequency voltage</b> to set the base voltage (for example, rated motor voltage).	707
		Change the <b>Pr.14 Load pattern selection</b> setting according to the load characteristic.	708
	The stall prevention (torque limit) function is activated due to a heavy load.	Reduce the load weight.	—
		Set <b>Pr.22 Stall prevention operation level (Torque limit level)</b> higher according to the load. (If <b>Pr.22</b> is set too high, an overcurrent trip (E.OC[]) is likely to occur.)	245, 431
	Offline auto tuning is not performed under Advanced magnetic flux vector control, Real sensorless vector control, or Vector control.	Check the capacities of the inverter and the motor.	—
When PM sensorless vector control is selected for an IPM motor other than MM-CF, offline auto tuning is not performed.	Perform offline auto tuning.	532	
	Perform offline auto tuning for the IPM motor.	551	

## 6.6.12 Speed does not accelerate

Check point	Possible cause	Countermeasure	Refer to page
Input signal	The start command or frequency command is chattering.	Check if the start command and the frequency command are correct.	—
	The wiring length is too long for the analog frequency command, causing a voltage (current) drop.	Perform the bias and gain calibration for the analog input.	505
	The input signal lines are affected by external EMI.	Take countermeasures against EMI, such as using shielded wires for input signal lines.	118
Parameter setting	<b>Pr.1 Maximum frequency, Pr.2 Minimum frequency, Pr.18 High speed maximum frequency</b> , and the calibration parameter <b>C2 to C7</b> settings are not appropriate.	Check the settings of <b>Pr.1</b> and <b>Pr.2</b> . To operate at 120 Hz or higher, set <b>Pr.18 High speed maximum frequency</b> .	428
		Check the <b>calibration parameter C2 to C7</b> settings.	505
	The maximum voltage (current) input value is not set during the External operation. ( <b>Pr.125, Pr.126, Pr.18</b> )	Check the settings of <b>Pr.125 Terminal 2 frequency setting gain frequency</b> and <b>Pr.126 Terminal 4 frequency setting gain frequency</b> . To operate at 120 Hz or higher, set <b>Pr.18</b> .	428, 505
	The torque boost ( <b>Pr.0, Pr.46, Pr.112</b> ) setting is not appropriate under V/F control, so the stall prevention function is activated.	Increase/decrease the <b>Pr.0 Torque boost</b> setting value by 0.5% increments so that stall prevention does not occur.	706
	The V/F pattern is not appropriate when V/F control is performed. ( <b>Pr.3, Pr.14, Pr.19</b> )	Set the rated frequency of the motor to <b>Pr.3 Base frequency</b> . Use <b>Pr.19 Base frequency voltage</b> to set the base voltage (for example, rated motor voltage).	707
		Change the <b>Pr.14 Load pattern selection</b> setting according to the load characteristic.	708
	The stall prevention (torque limit) function is activated due to a heavy load.	Reduce the load weight.	—
		Set <b>Pr.22 Stall prevention operation level (Torque limit level)</b> higher according to the load. (If <b>Pr.22</b> is set too high, an overcurrent trip (E.OC[]) is likely to occur.)	245, 431
	Auto tuning is not performed under Advanced magnetic flux vector control, Real sensorless vector control, or Vector control.	Check the capacities of the inverter and the motor.	—
		Perform offline auto tuning.	532
The setting of pulse train input is not appropriate.	Check the specification of the pulse generator (open collector output or complementary output) and check the adjustment of the pulse train and frequency ( <b>Pr.385 Frequency for zero input pulse</b> and <b>Pr.386 Frequency for maximum input pulse</b> ).	406	
During PID control, the output frequency is automatically controlled so that the measured value equals the set point.		601	
Main circuit	A brake resistor is connected across terminals P/+ and P1 or across P1 and PR by mistake.	Connect an optional brake resistor (FR-ABR) across terminals P/+ and PR.	97

## 6.6.13 Unable to write parameter setting

Check point	Possible cause	Countermeasure	Refer to page
<b>Input signal</b>	Operation is being performed (the STF or STR signal is ON).	Stop the operation. When <b>Pr.77 Parameter write selection</b> = "0 (initial value)", writing is enabled only during a stop.	345
<b>Parameter setting</b>	Parameter setting was attempted in the External operation mode.	Choose the PU operation mode. Or, set <b>Pr.77 Parameter write selection</b> = "2" to enable parameter writing regardless of the operation mode.	345, 389
	Parameter write is disabled by the <b>Pr.77 Parameter write selection</b> setting.	Check the <b>Pr.77</b> setting.	345
	The key lock mode is enabled by the <b>Pr.161 Frequency setting/key lock operation selection</b> setting.	Check the <b>Pr.161</b> setting.	341
	Operation mode and a writing device do not correspond.	Check <b>Pr.79, Pr.338, Pr.339, Pr.550</b> and <b>Pr.551</b> , and select an operation mode suitable for the purpose.	389, 400
	Under PM sensorless vector control, setting "25" in <b>Pr.72 PWM frequency selection</b> was attempted. Or, setting PM sensorless vector control was attempted while <b>Pr.72</b> = "25".	Under PM sensorless vector control, "25" cannot be set in <b>Pr.72</b> . (A sine wave filter (MT-BSL/BSC) cannot be used under PM sensorless vector control.)	356

## 6.6.14 Power lamp is not lit

Check point	Possible cause	Countermeasure	Refer to page
<b>Main circuit, control circuit</b>	The wiring or installation is inadequate.	Check for secure wiring and installation. The power lamp is lit when power is supplied to the control circuit (R1/L11, S1/L21).	54

# MEMO

# CHAPTER 7 PRECAUTIONS FOR MAINTENANCE AND INSPECTION

7.1	Inspection item.....	812
7.2	Measurement of main circuit voltages, currents, and powers.....	821



# 7 PRECAUTIONS FOR MAINTENANCE AND INSPECTION

---

This chapter explains the precautions for maintenance and inspection of this product.

Always read the instructions before use.

For the precautions for maintenance and inspection of the separated converter type inverter, refer to the FR-A802 (Separated Converter Type) Instruction Manual (Hardware).

For the precautions for maintenance and inspection of the IP55 compatible model inverter, refer to the FR-A806 (IP55/UL Type 12 specification) Instruction Manual (Hardware).

## 7.1 Inspection item

---

The inverter is a static unit mainly consisting of semiconductor devices. Daily inspection must be performed to prevent any fault from occurring due to the adverse effects of the operating environment, such as temperature, humidity, dust, dirt and vibration, changes in the parts with time, service life, and other factors.

### ◆ Precautions for maintenance and inspection

When accessing the inverter for inspection, wait for at least 10 minutes after the power supply has been switched OFF. Then, make sure that the voltage across the main circuit terminals P/+ and N/- on the inverter is not more than 30 VDC using a digital multimeter, etc.

### 7.1.1 Daily inspection

Basically, check for the following faults during operation.

- Motor operation fault
- Improper installation environment
- Cooling system fault
- Abnormal vibration, abnormal noise
- Abnormal overheat, discoloration

### 7.1.2 Periodic inspection

Check the areas inaccessible during operation and requiring periodic inspection. Consult us for periodic inspection.

Check and clean the cooling system:

Clean the air filter, etc.

Check the tightening and retighten:

The screws and bolts may become loose due to vibration, temperature changes, etc. Check and tighten them. Tighten them according to the specified tightening torque. (Refer to [page 57](#).)

Check the conductors and insulating materials for corrosion and damage.

Measure the insulation resistance.

Check and change the cooling fan and relay.

#### NOTE

- When using the safety stop function, periodic inspection is required to confirm that safety function of the safety system operates correctly. For more details, refer to the Safety Stop Function Instruction Manual.
-

## 7.1.3 Daily and periodic inspection

Area of inspection	Inspection item	Description	Inspection interval		Corrective action at fault occurrence	Check by user	
			Daily	Periodic <sup>*3</sup>			
General	Surrounding environment	Check the surrounding air temperature, humidity, dirt, corrosive gas, oil mist, etc.	○		Improve the environment.		
	Overall unit	Check for unusual vibration and noise.	○		Check fault location and retighten.		
		Check for dirt, oil, and other foreign material. <sup>*1</sup>	○		Clean.		
	Power supply voltage	Check that the main circuit voltage and control circuit voltage are normal. <sup>*2</sup>	○		Inspect the power supply.		
Main circuit	General	<ul style="list-style-type: none"> <li>• Check with megger (between main circuit terminals and earth (ground) terminal).</li> <li>• Check for loose screws and bolts.</li> <li>• Check for overheat traces on the parts.</li> <li>• Check for stains.</li> </ul>		○	Contact the manufacturer. Retighten. Contact the manufacturer. Clean.		
	Conductors and cables	<ul style="list-style-type: none"> <li>• Check conductors for distortion.</li> <li>• Check cable sheaths for breakage and deterioration (crack, discoloration, etc.).</li> </ul>		○	Contact the manufacturer. Contact the manufacturer.		
	Transformer/reactor	Check for unusual odor and abnormal increase of whining sound.	○		Stop the equipment and contact the manufacturer.		
	Terminal block	Check for a damage.		○	Stop the equipment and contact the manufacturer.		
	Smoothing aluminum electrolytic capacitor	<ul style="list-style-type: none"> <li>• Check for liquid leakage.</li> <li>• Check for safety valve projection and bulge.</li> <li>• Visual check and judge by the life check of the main circuit capacitor. (Refer to <a href="#">page 815.</a>)</li> </ul>		○	Contact the manufacturer. Contact the manufacturer.		
	Relay/contact	Check that the operation is normal and no chattering sound is heard.		○	Contact the manufacturer.		
	Resistor	<ul style="list-style-type: none"> <li>• Check for cracks in the resistor insulator.</li> <li>• Check for a break in the cable.</li> </ul>		○	Contact the manufacturer. Contact the manufacturer.		
Control circuit, protection circuit	Operation check	<ul style="list-style-type: none"> <li>• Check for an output voltage imbalance between phases while operating the inverter alone.</li> <li>• Check that no fault is found in protective and display circuits in a sequence protective operation test.</li> </ul>		○	Contact the manufacturer. Contact the manufacturer.		
	Components check	Overall	<ul style="list-style-type: none"> <li>• Check for unusual odor and discoloration.</li> <li>• Check for serious rust development.</li> </ul>		○	Stop the equipment and contact the manufacturer. Contact the manufacturer.	
		Aluminum electrolytic capacitor	<ul style="list-style-type: none"> <li>• Check for liquid leakage in a capacitor and deformation trace.</li> <li>• Visual check and judge by the life check of the control circuit capacitor. (Refer to <a href="#">page 815.</a>)</li> </ul>		○	Contact the manufacturer.	
Cooling system	Cooling fan	<ul style="list-style-type: none"> <li>• Check for unusual vibration and noise.</li> <li>• Check for loose screws and bolts.</li> <li>• Check for stains.</li> </ul>	○		Replace the fan. Fix with the fan cover fixing screws. Clean.		
	Heat sink	<ul style="list-style-type: none"> <li>• Check for clogging.</li> <li>• Check for stains.</li> </ul>		○	Clean. Clean.		

Area of inspection	Inspection item	Description	Inspection interval		Corrective action at fault occurrence	Check by user
			Daily	Periodic <sup>*3</sup>		
Display	Indication	<ul style="list-style-type: none"> <li>• Check that indications are correct.</li> <li>• Check for stains.</li> </ul>	○	○	Contact the manufacturer. Clean.	
	Meter/counter	Check that readouts are correct.	○		Stop the equipment and contact the manufacturer.	
Load motor	Operation check	Check for vibration and abnormal increase in operation noise.	○		Stop the equipment and contact the manufacturer.	

\*1 Oil component of the heat dissipation grease used inside the inverter may leak out. The oil component, however, is not flammable, corrosive, nor conductive and is not harmful to humans. Wipe off such oil component.

\*2 It is recommended to install a voltage monitoring device for checking the voltage of the power supplied to the inverter.

\*3 One to two years of periodic inspection cycle is recommended. However, it differs according to the installation environment. Consult us for periodic inspection.

### NOTE

- Continuous use of a leaked, deformed, or degraded smoothing aluminum electrolytic capacitor (as shown in the table above) may lead to a burst, breakage, or fire. Replace such capacitor without delay.

## 7.1.4 Checking the inverter and converter modules

### ◆ Preparation

- Disconnect the external power supply cables (R/L1, S/L2, T/L3) and motor cables (U, V, W).
- Prepare a continuity tester. (For the resistance measurement, use the 100 Ω range.)

### ◆ Checking method

Change the polarity of the tester alternately at the inverter terminals R/L1, S/L2, T/L3, U, V, W, P/+, and N/- and check the electric continuity.

### NOTE

- Before measurement, check that the smoothing capacitor is discharged.
- At the time of electric discontinuity, the measured value is almost ∞. When there is an instantaneous electric continuity, due to the smoothing capacitor, the tester may not indicate ∞. At the time of electric continuity, the measured value is several Ω to several tens of Ω. When all measured values are almost the same (although values may not be constant depending on the tester type), it shows that there are no electrical paths with problems.

### ◆ Module device numbers and terminals to be checked

		Tester polarity		Continuity		Tester polarity		Continuity
		⊕	⊖			⊕	⊖	
Converter module	D1	R/L1	P/+	No	D4	R/L1	N/-	Yes
		P/+	R/L1	Yes		N/-	R/L1	No
	D2	S/L2	P/+	No	D5	S/L2	N/-	Yes
		P/+	S/L2	Yes		N/-	S/L2	No
	D3	T/L3	P/+	No	D6	T/L3	N/-	Yes
		P/+	T/L3	Yes		N/-	T/L3	No
Inverter module	TR1	U	P/+	No	TR4	U	N/-	Yes
		P/+	U	Yes		N/-	U	No
	TR3	V	P/+	No	TR6	V	N/-	Yes
		P/+	V	Yes		N/-	V	No
	TR5	W	P/+	No	TR2	W	N/-	Yes
		P/+	W	Yes		N/-	W	No

(Assuming that an analog meter is used.)

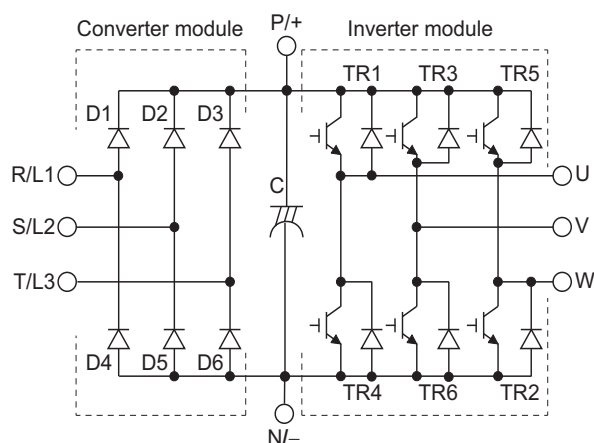

## 7.1.5 Cleaning

Always run the inverter in a clean status.

When cleaning the inverter, gently wipe dirty areas with a soft cloth immersed in neutral detergent or ethanol.

### NOTE

- Do not use solvent, such as acetone, benzene, toluene and alcohol, as these will cause the inverter surface paint to peel off.
- The display, etc. of the operation panel (FR-DU08) and parameter unit (FR-PU07) are vulnerable to detergent and alcohol. Therefore, avoid using them for cleaning.

7

## 7.1.6 Replacement of parts

The inverter consists of many electronic parts such as semiconductor devices.

The following parts may deteriorate with age because of their structures or physical characteristics, leading to reduced performance or fault of the inverter. For preventive maintenance, the parts must be replaced periodically.

Use the life check function as a guidance of parts replacement.

Part name	Estimated lifespan <sup>*1</sup>	Description
Cooling fan	10 years	Replace (as required)
Main circuit smoothing capacitor	10 years <sup>*2</sup>	Replace (as required)
On-board smoothing capacitor	10 years <sup>*2</sup>	Replace the board (as required).
Relays	—	As required
Main circuit fuse inside the inverter (FR-A840-04320(160K) or higher)	10 years	Replace (as required)

\*1 Estimated lifespan for when the yearly average surrounding air temperature is 40°C.  
(without corrosive gas, flammable gas, oil mist, dust and dirt etc.)

\*2 Output current: 80% of the inverter rating

### NOTE

- For parts replacement, contact the nearest Mitsubishi FA center.

## ◆ Inverter parts life display

The inverter diagnoses the main circuit capacitor, control circuit capacitor, cooling fan, and inrush current limit circuit by itself and estimates their lives.

The self-diagnostic warning is output when the life span of each part is near its end. It gives an indication of replacement time.

### Guideline for life judgment using the life warning output

Part	Judgment level
Main circuit capacitor	85% of the initial capacity
Control circuit capacitor	Estimated remaining life 10%
Inrush current limit circuit	Estimated remaining life 10% (Power ON: 100,000 times left)
Cooling fan	Less than the specified speed

**NOTE**

- Refer to [page 359](#) to perform the life check of the inverter parts.

## ◆ Replacement procedure of the cooling fan

The replacement interval of the cooling fan used for cooling the parts generating heat such as the main circuit semiconductor is greatly affected by the surrounding air temperature. When unusual noise and/or vibration are noticed during inspection, the cooling fan must be replaced immediately.

### ■ Removal (FR-A820-00105(1.5K) to 04750(90K), FR-A840-00083(2.2K) to 03610(132K))

1. Push the hooks from above and remove the fan cover.

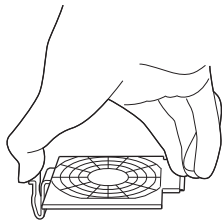

FR-A820-00105(1.5K) to 00250(3.7K)  
FR-A840-00083(2.2K), 00126(3.7K)

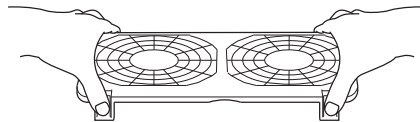

FR-A820-00340(5.5K) to 01540(30K)  
FR-A840-00170(5.5K) to 00770(30K)

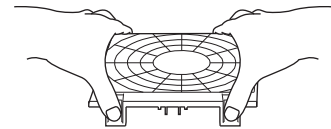

FR-A820-01870(37K) or higher  
FR-A840-00930(37K) to 03610(132K)

2. Disconnect the fan connectors.

3. Remove the fan.

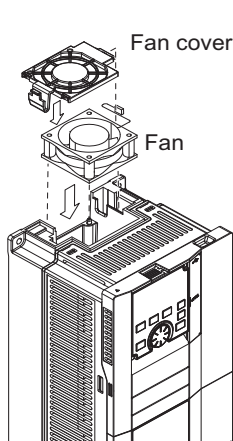

FR-A820-00105(1.5K) to 00250(3.7K)  
FR-A840-00083(2.2K), 00126(3.7K)

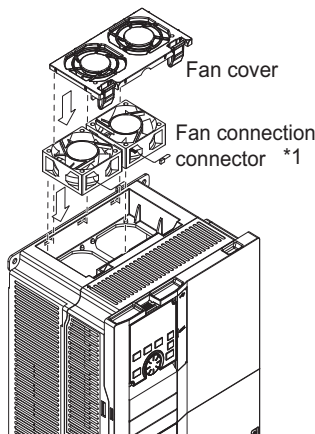

FR-A820-00340(5.5K) to 01540(30K)  
FR-A840-00170(5.5K) to 00770(30K)

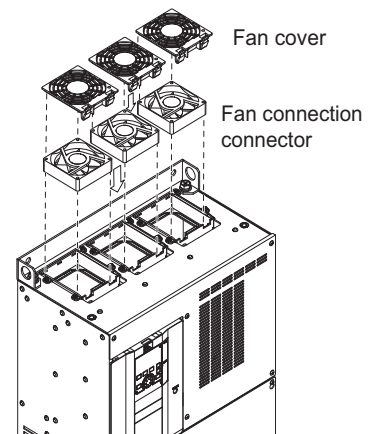

FR-A820-01870(37K) or higher  
FR-A840-00930(37K) to 03610(132K)

\*1 The number of cooling fans differs according to the inverter capacity.

### ■ Installation (FR-A820-00105(1.5K) to 04750(90K), FR-A840-00083(2.2K) to 03610(132K))

1. After confirming the orientation of the fan, install the fan so that the "AIR FLOW" arrow faces up.

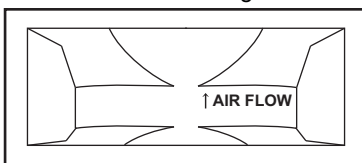

<Fan side face>

## 2. Connect the fan connectors.

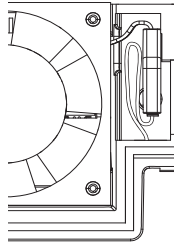

FR-A820-00105(1.5K) to 00250(3.7K)  
FR-A840-00083(2.2K), 00126(3.7K)

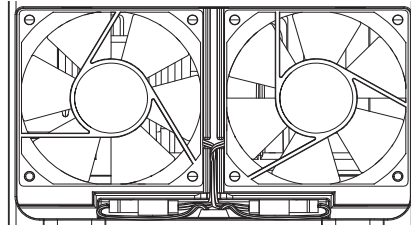

FR-A820-00340(5.5K) to 00770(15K)  
FR-A840-00170(5.5K) to 00380(15K)

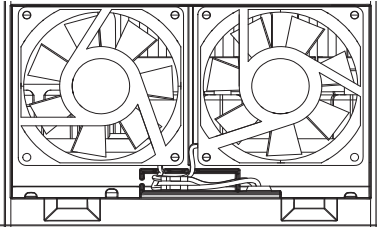

FR-A820-00930(18.5K), 01250(22K)  
FR-A840-00470(18.5K), 00620(22K)

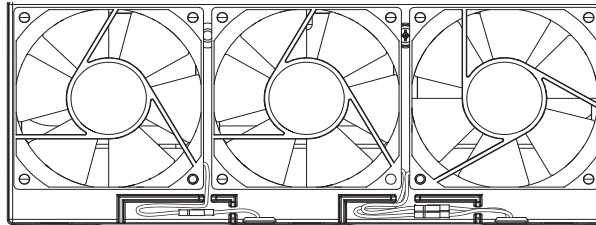

FR-A820-01540(30K)  
FR-A840-00770(30K)

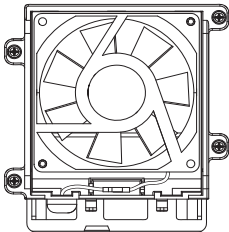

FR-A820-01870(37K), 02330(45K)  
FR-A840-00930(37K) to 01800(55K)

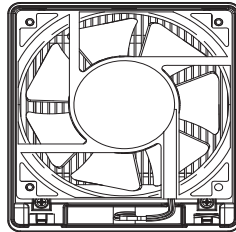

FR-A820-03160(55K) or higher  
FR-A840-02160(75K) to 03610(132K)

## 3. Install the fan cover.

2. Insert hooks until you hear a click sound.

1. Insert hooks into holes.

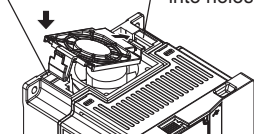

FR-A820-00105(1.5K) to 00250(3.7K)  
FR-A840-00083(2.2K), 00126(3.7K)

1. Insert hooks into holes.

2. Insert hooks until you hear a click sound.

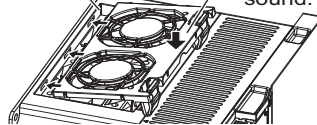

FR-A820-00340(5.5K) to 01540(30K)  
FR-A840-00170(5.5K) to 00770(30K)

1. Insert hooks into holes. 2. Insert hooks until you hear a click sound.



FR-A820-01870(37K) or higher  
FR-A840-00930(37K) to 03610(132K)

### NOTE

- Installing the fan in the opposite direction of air flow may shorten the inverter life.
- Ensure that the cables are not caught when the fan is installed.
- Switch OFF the power before starting the fan replacement work. To prevent an electric shock accident, keep the inverter with its covers on during fans replacement since the inverter circuits are charged with voltage even after power OFF.

### ■ Removal (FR-A840-04320(160K) or higher)

1. Remove the fan cover fixing screws, and remove the fan cover.
2. Disconnect the fan connector and remove the fan block.

**3.** Remove the fan fixing screws, and remove the fan.

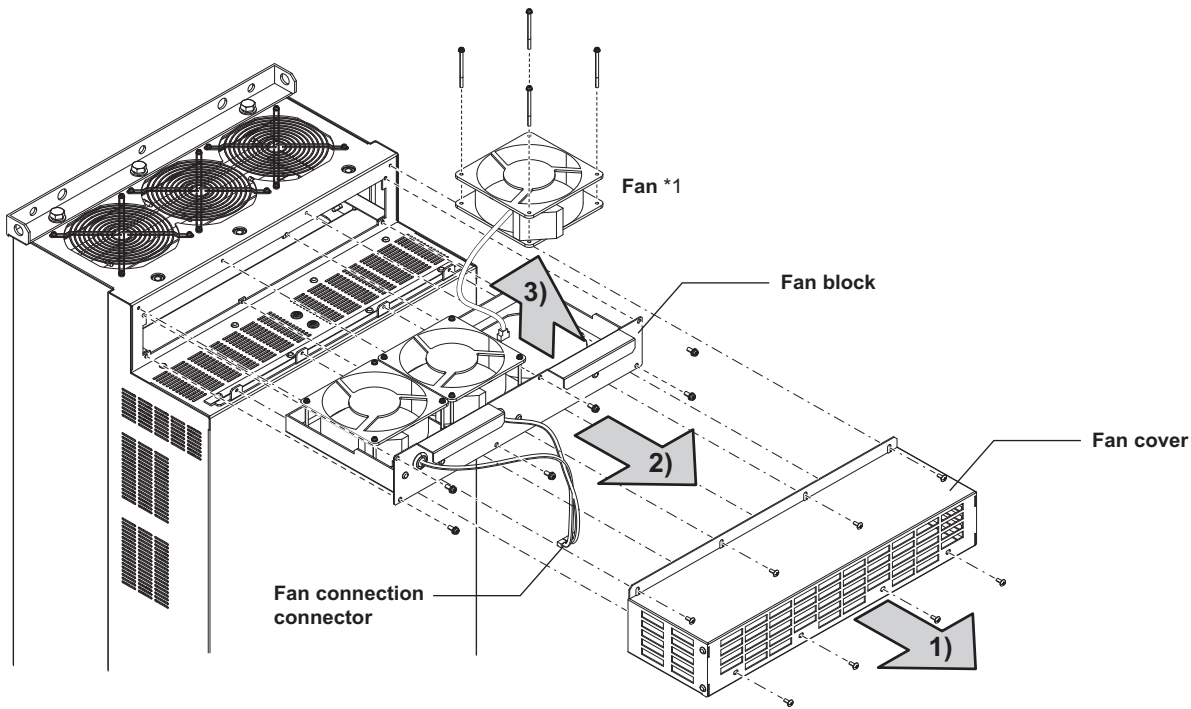

\*1 The number of cooling fans differs according to the inverter capacity.

**■ Installation (FR-A840-04320(160K) or higher)**

**1.** After confirming the orientation of the fan, install the fan so that the "AIR FLOW" arrow faces up.

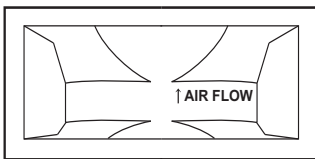

<Fan side face>

**2.** Install fans referring to the above figure.

The tightening torque of the fan fixing screws is 0.73 N·m.

**NOTE**

- Installing the fan in the opposite direction of air flow may shorten the inverter life.
- Ensure that the cables are not caught when the fan is installed.
- Switch OFF the power before starting the fan replacement work. To prevent an electric shock accident, keep the inverter with its covers on during fans replacement since the inverter circuits are charged with voltage even after power OFF.

**◆ Smoothing capacitors**

A large-capacity aluminum electrolytic capacitor is used for smoothing in the DC section of the main circuit, and an aluminum electrolytic capacitor is used for stabilizing the control power in the control circuit. Adverse effects from ripple currents deteriorate capacitors. Replacement intervals of capacitors vary greatly with surrounding temperatures and operating conditions. Replace them roughly every 10 years when used in normal air-conditioned environments.

Inspecting the product visually:

- Case: Check that the sides and bottom of the capacitor have not ruptured.
- Rubber seal: Check for any noticeable bulging or severe cracks.
- Check for external cracks, discoloration, leakage, etc. It is assumed that the capacitor has reached the end of its life when its capacity has dropped below 80% of its rated capacity.

**NOTE**

- The inverter diagnoses the main circuit capacitor and control circuit capacitor by itself and estimates its remaining life. (Refer to [page 359](#).)



## ◆ Relay output terminals

- The contacts of relays deteriorate over time. To prevent faults from occurring, relays must be replaced when they have reached the maximum of switching operations (switching life).
- The control terminal block must be replaced (refer to [page 819](#)) in case of failure of either relay between the relay output terminals C1 and B1 or A1, or terminals C2 and B2 or A2. After replacing the control terminal block, connect the jumper connector to the correct position in accordance with the control logic of input signals. (Refer to [page 72](#).)

## ◆ Main circuit fuse inside the inverter (FR-A840-04320(160K) or higher)

Fuses are used in some inverters. Replacement intervals of fuses vary greatly with surrounding temperatures and operating conditions. Replace them roughly every 10 years when used in normal air-conditioned environments.

## 7.1.7 Removal and reinstallation of the control circuit terminal block

This product has a removable control circuit terminal block, which can be replaced with a new one or a control terminal option.

### ◆ Removal and reinstallation

1. Loosen the two installation screws at the both side of the control circuit terminal block. (These screws cannot be removed.)  
Slide down the control circuit terminal block to remove it.

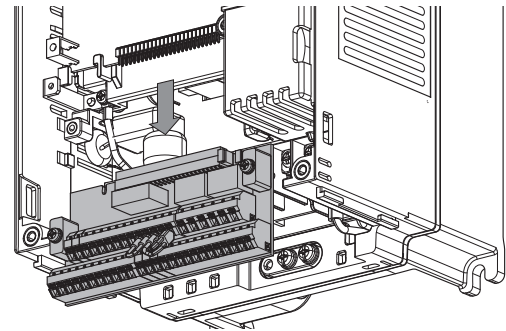
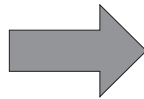
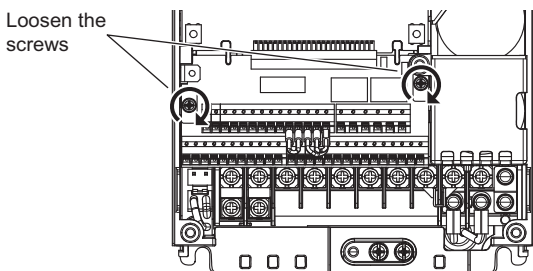

2. Be careful not to bend the pins of the inverter's control circuit connector, reinstall the control circuit terminal block and fix it with the mounting screws.

### NOTE

- Before starting the replacement, power OFF the inverter, wait for at least 10 minutes, and then check that the charge lamp is OFF to ensure safety.

### ◆ Removal and reinstallation precautions

The following are the precautions to remove or reinstall the control circuit terminal block. Observe the following precautions and handle the inverter properly to avoid malfunctions or failures.

- To remove or reinstall the control circuit terminal block, keep it upright so that it is parallel with the inverter.
- To install the control circuit terminal block, slide it upward so that the tongues on the inverter slot into the grooves on the terminal block.



- Check that the terminal block is parallel to the inverter and the pins on the inverter control circuit connector are not bent. After checking proper connection, fix the terminal block in place with two screws.

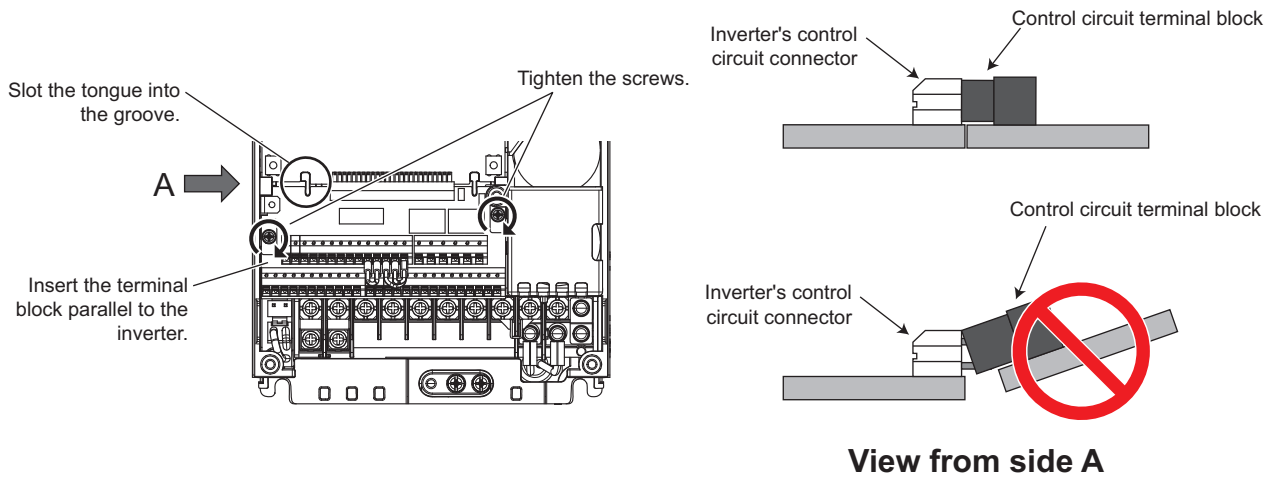

**NOTE**

- Do not tilt the terminal block while tightening the screws or removing it from the inverter. (Otherwise, a stress applied to the control circuit terminal block or the control circuit connector may cause damage to them.)
- After replacing the control terminal block, connect the jumper connector to the correct position in accordance with the control logic of input signals. (Refer to [page 72](#).)

## 7.2 Measurement of main circuit voltages, currents, and powers

Since the voltages and currents on the inverter power supply and output sides include harmonics, measurement data depends on the instruments used and circuits measured. When instruments for commercial frequency are used for measurement, measure the following circuits with the instruments given on the next page.

### NOTE

- When installing meters etc. on the inverter output side  
When the inverter-to-motor wiring length is long, especially in the 400 V class, small-capacity models, the meters and CTs may generate heat due to line-to-line leakage current. Therefore, choose the equipment which has enough allowance for the current rating.  
To measure and display the output voltage and output current of the inverter, it is recommended to use the terminal AM and FM/CA output functions of the inverter.

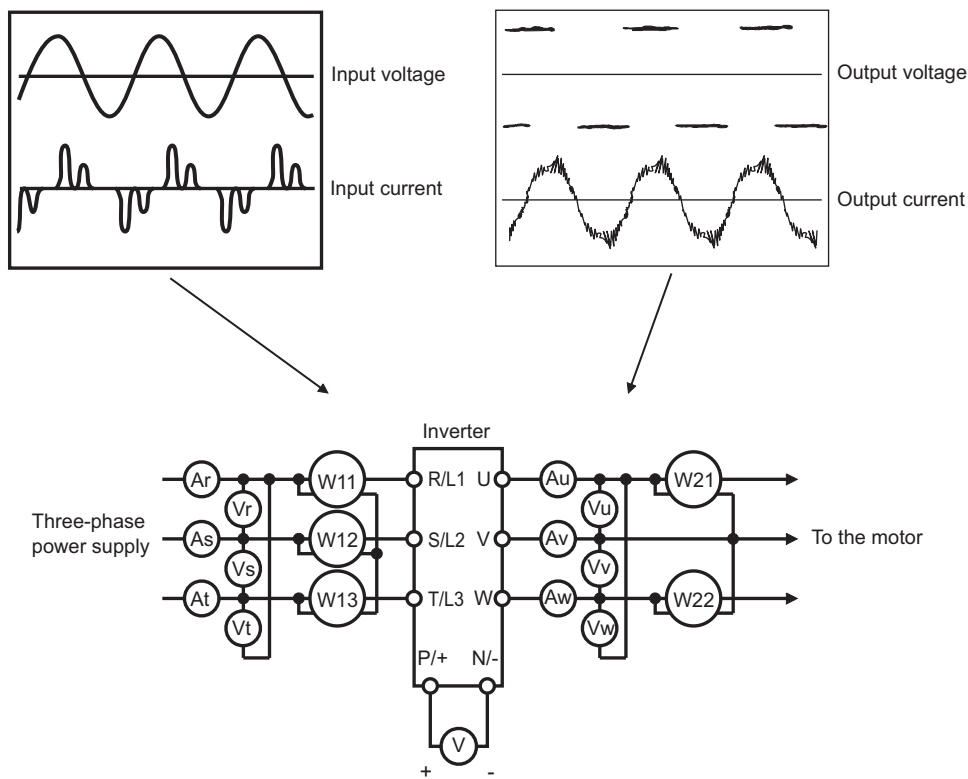

## ◆ Measuring points and instruments

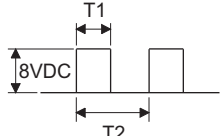
Item	Measuring point	Measuring instrument	Remarks (reference measured value)	
Input voltage V1	Between R/L1 and S/L2, S/L2 and T/L3, and T/L3 and R/L1	Digital power meter (designed for inverter)	Commercial power Within permissible AC voltage fluctuation. (Refer to page 826.)	
Input current I1	Line current at R/L1, S/L2, and T/L3			
Input power P1	At R/L1, S/L2, and T/L3, and between R/L1 and S/ L2, S/L2 and T/L3, and T/ L3 and R/L1		P1 = W11 + W12 + W13 (3-wattmeter method)	
Input power factor Pf1	Calculate after measuring input voltage, input current and input power. $Pf_1 = \frac{P_1}{\sqrt{3}V_1 \times I_1} \times 100\%$			
Output voltage V2	Between U and V, V and W, and W and U	Digital power meter (designed for inverter)*1	Difference between the phases must be within 1% of the maximum output voltage.	
Output current I2	Line current at U, V, and W	Digital power meter (designed for inverter)	Difference between the phases must be within 10%.	
Output power P2	At U, V, and W, and between U and V, and V and W		P2 = W21 + W22 2-wattmeter method (or 3-wattmeter method)	
Output power factor Pf2	Calculate in similar manner to the input power factor. $Pf_2 = \frac{P_2}{\sqrt{3}V_2 \times I_2} \times 100\%$			
Converter output	Between P/+ and N/-	Digital multimeter or other tester	Inverter LED indication 1.35 × V1	
Frequency setting signal	2, and between 4(+) and 5 Between 1(+) and 5	Digital multimeter or other tester, or moving-coil type instrument (internal resistance 50 kΩ or more)	0 to 10 VDC, 4 to 20 mA	
Power supply for a frequency setting potentiometer	Between 10(+) and 5		0 to ±5 VDC and 0 to ±10 VDC	
	Between 10E(+) and 5		5.2 VDC	
Frequency meter signal	Between AM(+) and 5		10 VDC	Terminal 5 is a common terminal.
	Between CA(+) and 5		Approximately 10 VDC at maximum frequency (without frequency meter)	
	Between FM(+) and SD		Approximately 20 mADC at maximum frequency Approximately 5 VDC at maximum frequency (without frequency meter)	Terminal SD is a common terminal.
Start signal, selection signal, reset signal, output stop signal	Between STF, STR, RH, RM, RL, JOG, RT, AU, STP (STOP), CS, RES, or MRS(+) and SD (for sink logic)		Approximately 8VDC  Pulse width T1: Adjust with <b>C0</b> <b>(Pr.900)</b> . Pulse cycle T2: Set with <b>Pr.55</b> (for frequency monitor only).	
Fault signal	Between A1 and C1 Between B1 and C1	Digital multimeter or other tester	Continuity check*2 Normal: discontinuity across A1 and C1 (continuity across B1 and C1) Fault: continuity across A1 and C1 (discontinuity across B1 and C1)	

\*1 Use an FFT to measure the output voltage accurately. A digital multimeter or general measuring instrument cannot measure accurately.

\*2 When the setting of **Pr.195 ABC1 terminal function selection** is the positive logic.

## 7.2.1 Measurement of powers

Use digital power meters (for inverter) both on the inverter's input and output sides.

## 7.2.2 Measurement of voltages

### ◆ Inverter input side

Use a digital power meter (for inverter) on the inverter's input side.

### ◆ Inverter output side

When using a measuring instrument, use a digital power meter for inverters as the inverter outputs PWM-controlled square wave voltage. The value monitored on the operation panel is the inverter-controlled voltage itself. Monitoring values via the operation panel or by outputting the analog signal is recommended as these values are accurate.

## 7.2.3 Measurement of currents

Use a digital power meter (for inverter) both on the inverter's input and output sides.

Since the inverter input current tends to be unbalanced, measurement of three phases is recommended. The correct value cannot be obtained by measuring only one or two phases. On the other hand, the unbalanced ratio of each phase of the output current should be within 10%.

The inverter output current can be monitored on the operation panel. The value displayed on the operation panel is accurate even if the output frequency varies. Hence, it is recommended to monitor values on the operation panel.

## 7.2.4 Measurement of inverter input power factor

Calculate the factor from the effective power and the apparent power. A power-factor meter cannot indicate an exact value.

$$\begin{aligned} \text{Total power factor of the inverter} &= \frac{\text{Effective power}}{\text{Apparent power}} \\ &= \frac{\text{Three-phase input power found by the 3-wattmeter method}}{\sqrt{3} \times V (\text{power supply voltage}) \times I (\text{input current effective value})} \end{aligned}$$

## 7.2.5 Measurement of converter output voltage (between terminals P and N)

The output voltage of the converter can be measured with a voltmeter (such as a digital multimeter) between terminals P and N. The voltage varies according to the power supply voltage. Approximately 270 to 300 VDC (540 to 600 VDC for the 400 V class) is output when no load is connected. The voltage decreases when a load is applied.

When energy is regenerated from the motor during deceleration, for example, the converter output voltage rises to nearly 400 to 450 VDC (800 to 900 VDC for the 400 V class) maximum.

## 7.2.6 Measurement of inverter output frequency

In the initial setting of the FM type inverter, a pulse train proportional to the output frequency is output across the pulse train output terminals FM and SD on the inverter. This pulse train output can be counted by a frequency counter, or a digital multimeter can be used to read the mean value of the pulse train output voltage. When a digital multimeter is used to measure the output frequency, approximately 5 VDC is indicated at the maximum frequency.

For detailed specifications of the pulse train output terminal FM, refer to [page 463](#).

In the initial setting of the CA type inverter, a pulse train proportional to the output frequency is output across the analog current output terminals CA and 5 on the inverter. Measure the current using a digital multimeter.

For detailed specifications of the analog current output terminal CA, refer to [page 465](#).

## 7.2.7 Insulation resistance test using megger

- For the inverter, conduct the insulation resistance test on the main circuit only as follows and do not perform the test on the control circuit.  
(Use a 500 VDC megger.)

### NOTE

- Before performing the insulation resistance test on the external circuit, disconnect the cables from all terminals of the inverter so that the test voltage is not applied to the inverter.
- For the continuity test of the control circuit, use a tester for high resistance range and do not use the megger or buzzer.

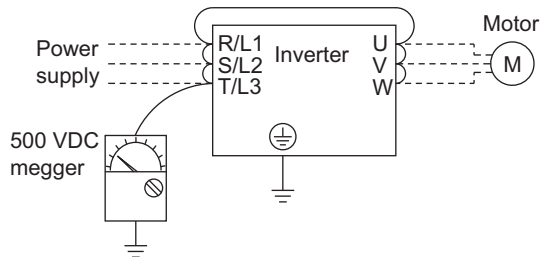

## 7.2.8 Withstand voltage test

Do not conduct a withstand voltage test. Deterioration may occur.

# CHAPTER 8 SPECIFICATIONS

8.1	Inverter rating.....	826
8.2	Motor rating.....	829
8.3	Common specifications.....	835
8.4	Outline dimension drawings.....	837

# 8 SPECIFICATIONS

This chapter explains the specifications of this product.

Always read the instructions before use.

For the separated converter type inverter, refer to "SPECIFICATIONS" in the FR-A802 (Separated Converter Type) Instruction Manual (Hardware).

For the IP55 compatible model inverter, refer to "SPECIFICATIONS" in the FR-A806 (IP55/UL Type12 specification) Instruction Manual (Hardware).

## 8.1 Inverter rating

### ◆ 200 V class

Model FR-A820-□		00046	00077	00105	00167	00250	00340	00490	00630	00770	00930	01250	01540	01870	02330	03160	03800	04750		
		0.4K	0.75K	1.5K	2.2K	3.7K	5.5K	7.5K	11K	15K	18.5K	22K	30K	37K	45K	55K	75K	90K		
Applicable motor capacity (kW) <sup>*1</sup>	SLD	0.75	1.5	2.2	3.7	5.5	7.5	11	15	18.5	22	30	37	45	55	75	90/110	132		
	LD	0.75	1.5	2.2	3.7	5.5	7.5	11	15	18.5	22	30	37	45	55	75	90	110		
	ND (initial setting)	0.4	0.75	1.5	2.2	3.7	5.5	7.5	11	15	18.5	22	30	37	45	55	75	90		
	HD	0.2 <sup>*2</sup>	0.4	0.75	1.5	2.2	3.7	5.5	7.5	11	15	18.5	22	30	37	45	55	75		
Rated capacity (kVA) <sup>*3</sup>	SLD	1.8	2.9	4	6.4	10	13	19	24	29	35	48	59	71	89	120	145	181		
	LD	1.6	2.7	3.7	5.8	8.8	12	17	22	27	32	43	53	65	81	110	132	165		
	ND (initial setting)	1.1	1.9	3	4.2	6.7	9.1	13	18	23	29	34	44	55	67	82	110	132		
	HD	0.6	1.1	1.9	3	4.2	6.7	9.1	13	18	23	29	34	44	55	67	82	110		
Rated current (A)	SLD	4.6	7.7	10.5	16.7	25	34	49	63	77	93	125	154	187	233	316	380	475		
	LD	4.2	7	9.6	15.2	23	31	45	58	70.5	85	114	140	170	212	288	346	432		
	ND (initial setting)	3	5	8	11	17.5	24	33	46	61	76	90	115	145	175	215	288	346		
	HD	1.5	3	5	8	11	17.5	24	33	46	61	76	90	115	145	175	215	288		
Output Overload current rating <sup>*4</sup>	SLD	110% 60 s, 120% 3 s (inverse-time characteristics) at surrounding air temperature of 40°C																		
	LD	120% 60 s, 150% 3 s (inverse-time characteristics) at surrounding air temperature of 50°C																		
	ND (initial setting)	150% 60 s, 200% 3 s (inverse-time characteristics) at surrounding air temperature of 50°C																		
	HD	200% 60 s, 250% 3 s (inverse-time characteristics) at surrounding air temperature of 50°C																		
Rated voltage <sup>*5</sup>		Three-phase 200 to 240 V																		
Regenerative braking		Brake transistor: Built-in FR-BU2 (option)																		
Maximum brake torque <sup>*7</sup>		150% torque, 3% ED <sup>*6</sup>			100% torque, 3% ED <sup>*6</sup>			100% torque, 2% ED <sup>*6</sup>			20% torque, continuous				10% torque, continuous					
when the option FR-ABR is used		150% torque, 10% ED			100% torque, 10% ED				100% torque, 6% ED				—							
Rated input AC voltage/frequency		Three-phase 200 to 240 V, 50/60 Hz																		
Permissible AC voltage fluctuation		170 to 264 V, 50/60 Hz																		
Permissible frequency fluctuation		±5%																		
Power supply Rated input current (A) <sup>*8</sup>	Without DC reactor	SLD	5.3	8.9	13.2	19.7	31.3	45.1	62.8	80.6	96.7	115	151	185	221	269	—	—	—	
		LD	5	8.3	12.2	18.3	28.5	41.6	58.2	74.8	90.9	106	139	178	207	255	—	—	—	
		ND (initial setting)	3.9	6.3	10.6	14.1	22.6	33.4	44.2	60.9	80	96.3	113	150	181	216	266	—	—	
		HD	2.3	3.9	6.3	10.6	14.1	22.6	33.4	44.2	60.9	80	96.3	113	150	181	216	—	—	
	With DC reactor	SLD	4.6	7.7	10.5	16.7	25	34	49	63	77	93	125	154	187	233	316	380	475	
		LD	4.2	7	9.6	15.2	23	31	45	58	70.5	85	114	140	170	212	288	346	432	
		ND (initial setting)	3	5	8	11	17.5	24	33	46	61	76	90	115	145	175	215	288	346	
		HD	1.5	3	5	8	11	17.5	24	33	46	61	76	90	115	145	175	215	288	
	Power supply capacity (kVA) <sup>*9</sup>	Without DC reactor	SLD	2	3.4	5	7.5	12	17	24	31	37	44	58	70	84	103	—	—	—
			LD	1.9	3.2	4.7	7	11	16	22	29	35	41	53	68	79	97	—	—	—
			ND (initial setting)	1.5	2.4	4	5.4	8.6	13	17	23	30	37	43	57	69	82	101	—	—
			HD	0.9	1.5	2.4	4	5.4	8.6	13	17	23	30	37	43	57	69	82	—	—
With DC reactor		SLD	1.8	2.9	4	6.4	10	13	19	24	29	35	48	59	71	89	120	145	181	
		LD	1.6	2.7	3.7	5.8	8.8	12	17	22	27	32	43	53	65	81	110	132	165	
		ND (initial setting)	1.1	1.9	3	4.2	6.7	9.1	13	18	23	29	34	44	55	67	82	110	132	
		HD	0.6	1.1	1.9	3	4.2	6.7	9.1	13	18	23	29	34	44	55	67	82	110	
Protection rating of structure (IEC 60529) <sup>*10</sup>		Enclosed type											Open type (IP00)							
Cooling system		Natural			Forced air															
Approx. mass (kg)		2.0	2.2	3.4	3.4	3.4	6.7	6.7	8.3	15.5	15.5	15.5	22	42	42	54	74	74		

\*1 The applicable motor capacity indicated is the maximum capacity applicable for use of the Mitsubishi Electric standard 4-pole motor.

- \*2 A 0.2 kW motor can be operated under V/F control only.  
 \*3 The rated output capacity is the value with respect to 220 V output voltage.  
 \*4 The percentage of the overload current rating is the ratio of the overload current to the inverter's rated output current. For repeated duty, allow time for the inverter and motor to return to or below the temperatures under 100% load.  
 \*5 The maximum output voltage does not exceed the power supply voltage. The maximum output voltage can be changed within the setting range.  
 However, the maximum point of the voltage waveform at the inverter output side is the power supply voltage multiplied by about  $\sqrt{2}$ .  
 \*6 The built-in brake resistor is used.  
 \*7 Value for the ND rating  
 \*8 The rated input current is the value at a rated output voltage. The input power impedances (including those of the input reactor and cables) affect the value.  
 \*9 The power supply capacity is the value at the rated output current. The input power impedances (including those of the input reactor and cables) affect the value.  
 \*10 FR-DU08: IP40 (except for the PU connector)

## ◆ 400 V class

### ■ 00023 to 01800

Model FR-A840-□		00023	00038	00052	00083	00126	00170	00250	00310	00380	00470	00620	00770	00930	01160	01800		
		0.4K	0.75K	1.5K	2.2K	3.7K	5.5K	7.5K	11K	15K	18.5K	22K	30K	37K	45K	55K		
Applicable motor capacity (kW) <sup>*1</sup>	SLD	0.75	1.5	2.2	3.7	5.5	7.5	11	15	18.5	22	30	37	45	55	75/90		
	LD	0.75	1.5	2.2	3.7	5.5	7.5	11	15	18.5	22	30	37	45	55	75		
	ND (initial setting)	0.4	0.75	1.5	2.2	3.7	5.5	7.5	11	15	18.5	22	30	37	45	55		
	HD	0.2 <sup>*2</sup>	0.4	0.75	1.5	2.2	3.7	5.5	7.5	11	15	18.5	22	30	37	45		
Output	Rated capacity (kVA) <sup>*3</sup>	SLD	1.8	2.9	4	6.3	10	13	19	24	29	36	47	59	71	88	137	
		LD	1.6	2.7	3.7	5.8	8.8	12	18	22	27	33	43	53	65	81	110	
		ND (initial setting)	1.1	1.9	3	4.6	6.9	9.1	13	18	24	29	34	43	54	66	84	
		HD	0.6	1.1	1.9	3	4.6	6.9	9.1	13	18	24	29	34	43	54	66	
	Rated current (A)	SLD	2.3	3.8	5.2	8.3	12.6	17	25	31	38	47	62	77	93	116	180	
		LD	2.1	3.5	4.8	7.6	11.5	16	23	29	35	43	57	70	85	106	144	
		ND (initial setting)	1.5	2.5	4	6	9	12	17	23	31	38	44	57	71	86	110	
		HD	0.8	1.5	2.5	4	6	9	12	17	23	31	38	44	57	71	86	
	Overload current rating <sup>*4</sup>	SLD	110% 60 s, 120% 3 s (inverse-time characteristics) at surrounding air temperature of 40°C															
		LD	120% 60 s, 150% 3 s (inverse-time characteristics) at surrounding air temperature of 50°C															
		ND (initial setting)	150% 60 s, 200% 3 s (inverse-time characteristics) at surrounding air temperature of 50°C															
		HD	200% 60 s, 250% 3 s (inverse-time characteristics) at surrounding air temperature of 50°C															
Rated voltage <sup>*5</sup>		Three-phase 380 to 500 V																
Regenerative braking	Brake transistor	Built-in																
	Maximum brake torque <sup>*7</sup>	100% torque, 2% ED <sup>*6</sup>									20% torque, continuous							
	when the option FR-ABR is used	100% torque, 10% ED									100% torque, 6% ED							
Rated input AC voltage/frequency		Three-phase 380 to 500 V, 50/60 Hz <sup>*11</sup>																
Permissible AC voltage fluctuation		323 to 550 V, 50/60 Hz																
Permissible frequency fluctuation		±5%																
Power supply	Rated input current (A) <sup>*8</sup>	Without DC reactor	SLD	3.2	5.4	7.8	10.9	16.4	22.5	31.7	40.3	48.2	58.4	76.8	97.6	115	141	—
			LD	3	4.9	7.3	10.1	15.1	22.3	31	38.2	44.9	53.9	75.1	89.7	106	130	—
			ND (initial setting)	2.3	3.7	6.2	8.3	12.3	17.4	22.5	31	40.3	48.2	56.5	75.1	91	108	134
			HD	1.4	2.3	3.7	6.2	8.3	12.3	17.4	22.5	31	40.3	48.2	56.5	75.1	91	108
		With DC reactor	SLD	2.3	3.8	5.2	8.3	12.6	17	25	31	38	47	62	77	93	116	180
			LD	2.1	3.5	4.8	7.6	11.5	16	23	29	35	43	57	70	85	106	144
			ND (initial setting)	1.5	2.5	4	6	9	12	17	23	31	38	44	57	71	86	110
			HD	0.8	1.5	2.5	4	6	9	12	17	23	31	38	44	57	71	86
	Power supply capacity (kVA) <sup>*9</sup>	Without DC reactor	SLD	2.5	4.1	5.9	8.3	12	17	24	31	37	44	59	74	88	107	—
			LD	2.3	3.7	5.5	7.7	12	17	24	29	34	41	57	68	81	99	—
			ND (initial setting)	1.7	2.8	4.7	6.3	9.4	13	17	24	31	37	43	57	69	83	102
			HD	1.1	1.7	2.8	4.7	6.3	9.4	13	17	24	31	37	43	57	69	83
		With DC reactor	SLD	1.8	2.9	4	6.3	10	13	19	24	29	36	47	59	71	88	137
			LD	1.6	2.7	3.7	5.8	8.8	12	18	22	27	33	43	53	65	81	110
			ND (initial setting)	1.1	1.9	3	4.6	6.9	9.1	13	18	24	29	34	43	54	66	84
			HD	0.6	1.1	1.9	3	4.6	6.9	9.1	13	18	24	29	34	43	54	66
Protection rating of structure (IEC 60529) <sup>*10</sup>		Enclosed type												Open type (IP00)				
Cooling system		Natural					Forced air											
Approx. mass (kg)		3.0	3.0	3.0	3.4	3.4	6.7	6.7	8.3	8.3	15	15	23	41	41	43		

- \*1 The applicable motor capacity indicated is the maximum capacity applicable for use of the Mitsubishi Electric standard 4-pole motor.  
 \*2 A 0.2 kW motor can be operated under V/F control only.  
 \*3 The rated output capacity is the value with respect to 440 V output voltage.  
 \*4 The percentage of the overload current rating is the ratio of the overload current to the inverter's rated output current. For repeated duty, allow time for the inverter and motor to return to or below the temperatures under 100% load.



- \*5 The maximum output voltage does not exceed the power supply voltage. The maximum output voltage can be changed within the setting range. However, the maximum point of the voltage waveform at the inverter output side is the power supply voltage multiplied by about  $\sqrt{2}$ .
- \*6 The built-in brake resistor is used.
- \*7 Value for the ND rating
- \*8 The rated input current is the value at a rated output voltage. The input power impedances (including those of the input reactor and cables) affect the value.
- \*9 The power supply capacity is the value at the rated output current. The input power impedances (including those of the input reactor and cables) affect the value.
- \*10 FR-DU08: IP40 (except for the PU connector)
- \*11 For the power voltage exceeding 480 V, set **Pr.977 Input voltage mode selection**. (For details, refer to [page 345](#).)
- \*12 The braking capability of the inverter can be improved with a commercial brake resistor. (For details, refer to [page 97](#).)

## ■ 02160 to 06830

Model FR-A840-[]		02160	02600	03250	03610	04320	04810	05470	06100	06830		
		75K	90K	110K	132K	160K	185K	220K	250K	280K		
Applicable motor capacity (kW) <sup>*1</sup>	SLD	110	132	160	185	220	250	280	315	355		
	LD	90	110	132	160	185	220	250	280	315		
	ND (initial setting)	75	90	110	132	160	185	220	250	280		
	HD	55	75	90	110	132	160	185	220	250		
Rated capacity (kVA) <sup>*2</sup>	SLD	165	198	248	275	329	367	417	465	521		
	LD	137	165	198	248	275	329	367	417	465		
	ND (initial setting)	110	137	165	198	248	275	329	367	417		
	HD	84	110	137	165	198	248	275	329	367		
Rated current (A)	SLD	216	260	325	361	432	481	547	610	683		
	LD	180	216	260	325	361	432	481	547	610		
	ND (initial setting)	144	180	216	260	325	361	432	481	547		
	HD	110	144	180	216	260	325	361	432	481		
Overload current rating <sup>*3</sup>	SLD	110% 60 s, 120% 3 s (inverse-time characteristics) at surrounding air temperature of 40°C										
	LD	120% 60 s, 150% 3 s (inverse-time characteristics) at surrounding air temperature of 50°C										
	ND (initial setting)	150% 60 s, 200% 3 s (inverse-time characteristics) at surrounding air temperature of 50°C										
	HD	200% 60 s, 250% 3 s (inverse-time characteristics) at surrounding air temperature of 50°C										
Rated voltage <sup>*4</sup>		Three-phase 380 to 500 V										
Regenerative braking	Brake transistor	FR-BU2 (option)										
	Maximum brake torque <sup>*5</sup> when the option FR-ABR is used	10% torque, continuous										
Rated input AC voltage/frequency		Three-phase 380 to 500 V, 50/60 Hz <sup>*9</sup>										
Permissible AC voltage fluctuation		323 to 550 V, 50/60 Hz										
Permissible frequency fluctuation		±5%										
Power supply	Rated input current (A) <sup>*6</sup>	With DC reactor	SLD	216	260	325	361	432	481	547	610	683
			LD	180	216	260	325	361	432	481	547	610
			ND (initial setting)	144	180	216	260	325	361	432	481	547
			HD	110	144	180	216	260	325	361	432	481
	Power supply capacity (kVA) <sup>*7</sup>	With DC reactor	SLD	165	198	248	275	329	367	417	465	521
			LD	137	165	198	248	275	329	367	417	465
			ND (initial setting)	110	137	165	198	248	275	329	367	417
			HD	84	110	137	165	198	248	275	329	367
	Protection rating of structure (IEC 60529) <sup>*8</sup>		Open type (IP00)									
	Cooling system		Forced air									
	Approx. mass (kg)		52	55	71	78	117	117	166	166	166	

- \*1 The applicable motor capacity indicated is the maximum capacity applicable for use of the Mitsubishi Electric standard 4-pole motor.
- \*2 The rated output capacity is the value with respect to 440 V output voltage.
- \*3 The percentage of the overload current rating is the ratio of the overload current to the inverter's rated output current. For repeated duty, allow time for the inverter and motor to return to or below the temperatures under 100% load.
- \*4 The maximum output voltage does not exceed the power supply voltage. The maximum output voltage can be changed within the setting range. However, the maximum point of the voltage waveform at the inverter output side is the power supply voltage multiplied by about  $\sqrt{2}$ .
- \*5 Value for the ND rating
- \*6 The rated input current is the value at a rated output voltage. The input power impedances (including those of the input reactor and cables) affect the value.
- \*7 The power supply capacity is the value at the rated output current. The input power impedances (including those of the input reactor and cables) affect the value.
- \*8 FR-DU08: IP40 (except for the PU connector)
- \*9 For the power voltage exceeding 480 V, set **Pr.977 Input voltage mode selection**. (For details, refer to [page 345](#).)

## 8.2 Motor rating

### 8.2.1 Vector control dedicated motor SF-V5RU (1500 r/min series)

#### ◆ Motor specifications

##### ■ 200 V class

Motor model: SF-V5RU□□K	1	2	3	5	7	11	15	18	22	30	37	45	55
Applicable inverter model: FR-A820-□□K (ND rating)	2.2	3.7	5.5	7.5	11	15	18.5	22	30	37	45	55	75
Rated output power (kW)	1.5	2.2	3.7	5.5	7.5	11	15	18.5	22	30* <sup>1</sup>	37* <sup>1</sup>	45* <sup>1</sup>	55
Rated current (A)	8.5	11.5	17.6	28.5	37.5	54	72.8	88	102	126	168	198	264
Rated torque (N·m)	9.55	14.1	23.6	35.0	47.7	70.0	95.5	118	140	191	235	286	350
Maximum torque at 150% 60 s (N·m)	14.3	21.1	35.4	52.4	71.6	105	143	176	211	287	353	429	525
Rated speed (r/min)	1500												
Maximum speed (r/min)	3000 <sup>2</sup>												2400
Frame No.	90L	100L	112M	132S	132M	160M	160L	180M	180M	200L	200L	200L	225S
Inertia moment J (×10 <sup>-4</sup> kg·m <sup>2</sup> )	67.5	105	175	275	400	750	875	1725	1875	3250	3625	3625	6850
Noise <sup>5</sup>	75 dB or less									80 dB or less		85 dB or less	
Cooling fan (with thermal protector) <sup>7*</sup> 8	Voltage		Single-phase 200 V 50 Hz / Single-phase 200 to 230 V 60 Hz					Three-phase 200 V 50 Hz / Three-phase 200 to 230 V 60 Hz					
	Input <sup>3</sup>		36/55 W (0.26/0.32 A)		22/28 W (0.11/ 0.13 A)		55/71 W (0.37/0.39 A)			100/156 W (0.47/0.53 A)		85/130 W (0.46/0.52 A)	
	Recommended thermal setting		0.36 A		0.18 A		0.51 A			0.69 A		0.68 A	
Surrounding air temperature and humidity	-10 to +40°C (non-freezing), 90% RH or less (non-condensing)												
Structure (Protection rating)	Totally enclosed forced ventilated (Motor: IP44, Cooling fan: IP23S) <sup>4</sup>												
Detector	Encoder 2048P/R, A phase, B phase, Z phase, +12 V/24 VDC power supply <sup>6</sup>												
Equipment	Encoder, thermal protector, fan												
Insulation class	F												
Vibration rank	V10												
Approx. mass (kg)	24	33	41	52	62	99	113	138	160	238	255	255	320

## ■ 400 V class

Motor model: SF-V5RUH□□K	1	2	3	5	7	11	15	18	22	30	37	45	55
Applicable inverter model: FR-A840-□□K (ND rating)	2.2	2.2	3.7	7.5	11	15	18.5	22	30	37	45	55	75
Rated output power (kW)	1.5	2.2	3.7	5.5	7.5	11	15	18.5	22	30 <sup>*1</sup>	37 <sup>*1</sup>	45 <sup>*1</sup>	55
Rated current (A)	4.2	5.8	8.8	14.5	18.5	27.5	35.5	44	51	67	84	99	132
Rated torque (N·m)	9.55	14.1	23.6	35.0	47.7	70.0	95.5	118	140	191	235	286	350
Maximum torque at 150% 60 s (N·m)	14.3	21.1	35.4	52.4	71.6	105	143	176	211	287	353	429	525
Rated speed (r/min)	1500												
Maximum speed (r/min)	3000 <sup>*2</sup>												2400
Frame No.	90L	100L	112M	132S	132M	160M	160L	180M	180M	200L	200L	200L	225S
Inertia moment J (×10 <sup>-4</sup> kg·m <sup>2</sup> )	67.5	105	175	275	400	750	875	1725	1875	3250	3625	3625	6850
Noise <sup>*5</sup>	75 dB or less									80 dB or less		85 dB or less	
Cooling fan (with thermal protector) <sup>*7*</sup> 8	Voltage		Single-phase 200 V 50 Hz / Single-phase 200 to 230 V 60 Hz					Three-phase 380 to 400 V 50 Hz / Three-phase 400 to 460 V 60 Hz					
	Input <sup>*3</sup>		36/55 W (0.26/0.32 A)		22/28 W (0.11/0.13 A)		55/71 W (0.19/0.19 A)			100/156 W (0.27/0.30 A)		85/130 W (0.23/0.26 A)	
	Recommended thermal setting		0.36 A		0.18 A		0.25 A			0.39 A		0.34 A	
Surrounding air temperature and humidity	-10 to +40°C (non-freezing), 90% RH or less (non-condensing)												
Structure (Protection rating)	Totally enclosed forced ventilated (Motor: IP44, Cooling fan: IP23S) <sup>*4</sup>												
Detector	Encoder 2048P/R, A phase, B phase, Z phase, +12 V/24 VDC power supply <sup>*6</sup>												
Equipment	Encoder, thermal protector, fan												
Insulation class	F												
Vibration rank	V10												
Approx. mass (kg)	24	33	41	52	62	99	113	138	160	238	255	255	320

\*1 80% output in the high-speed range. (The output is reduced when the speed is 2400 r/min or faster.) (Contact us separately for details.)

\*2 The maximum speed of a 3.7 kW motor or less is 3600 r/min. Consult our sales office for use of these motor.

\*3 Power (current) at 50/60 Hz.

\*4 Since a brake motor has a window for gap check, the protection rating of both the cooling fan section and brake section of the motor is IP20. The letter S in IP23S is an additional code indicating that a cooling fan was checked for water protection while it is stationary.

\*5 The value shown is applicable to the motor at high carrier frequency (Pr.72 = 6 and Pr.240 = 0).

\*6 A separate power supply of 12/24 V is required for the encoder. (When the FR-A8TP is installed on the inverter, the 24 V power supply from the FR-A8TP is available.)

\*7 The cooling fan is equipped with a thermal protector. The cooling fan stops when the coil temperature exceeds the specified value in order to protect the fan motor. A restrained cooling fan or degraded fan motor insulation could be causes for the rise in coil temperature. The cooling fan re-starts when the coil temperature drops to normal.

\*8 The cooling fan voltage and input values are the basic specifications of the cooling fan alone and free air values. The input value becomes slightly larger when it is rotated by this motor due to an increased workload, but the cooling fan can be used as it is. When preparing a thermal relay at the user side, use the recommended thermal setting.

## ◆ Motor torque

The torque characteristics of the SF-V5RU series driven by the inverter are shown in graph form as follows.

These are the case of the motor driven by the inverter at ND or HD rating. As the overload capacity decreases in the case of LD or SLD rating, observe the specified range of the inverter.

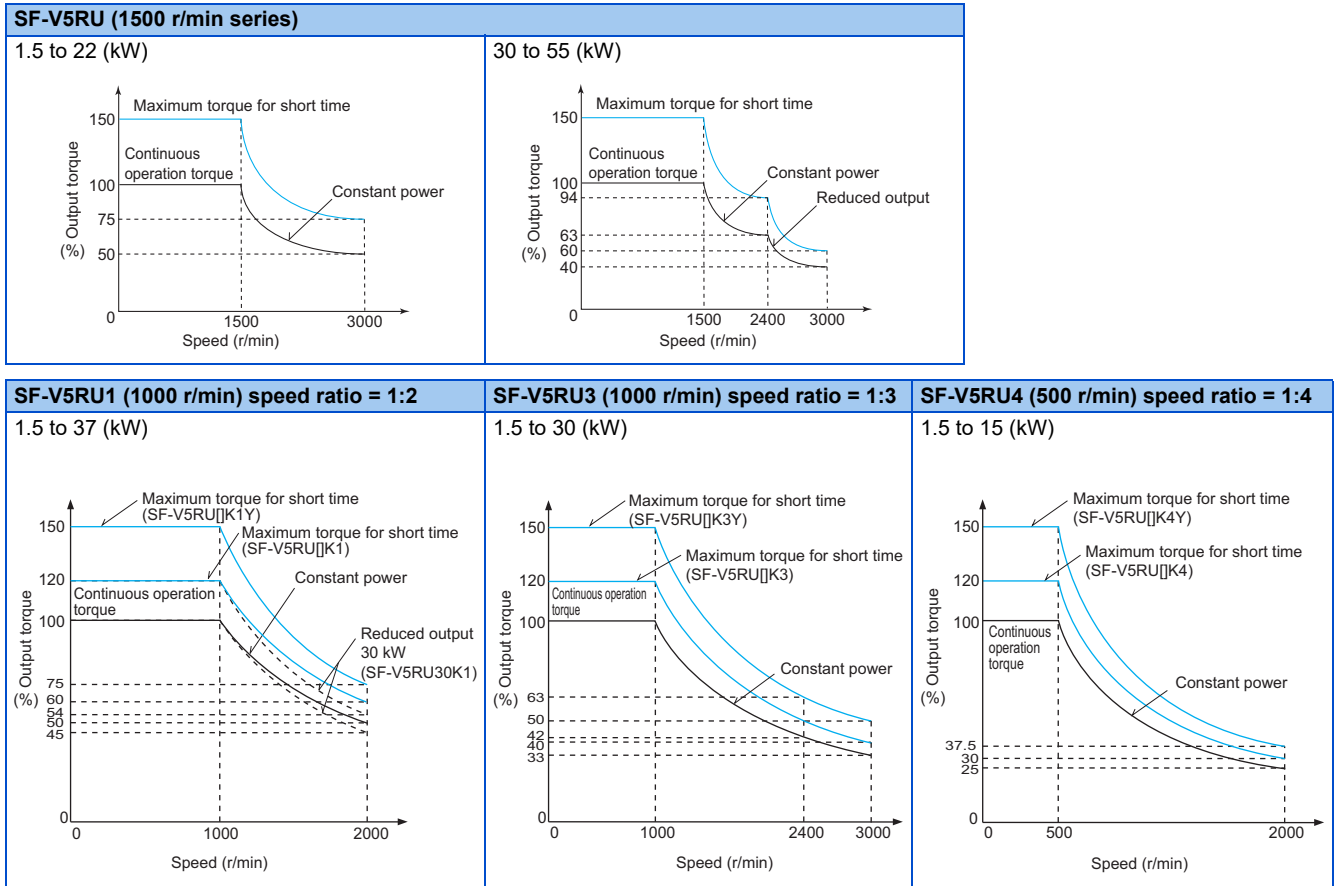

- The maximum speed of the SF-V5RU55K and SF-V5RU30K3 is 2400 r/min.
- The maximum speed of a 3.7 kW motor or less is 3600 r/min. Consult our sales office for use of these motor.
- The maximum speed of a brake motor is 1800 r/min.
- The maximum short-time torque of the SF-V5RU[K1], SF-V5RU[K3], and SF-V5RU[K4] is 120% of the rated torque. The maximum short-time torque of the SF-V5RU[K1Y], SF-V5RU[K3Y], and SF-V5RU[K4Y] is 150% of the rated torque.

## 8.2.2 Vector control dedicated motor SF-THY

### ◆ Motor specifications

Motor model		SF-THY										
Applicable inverter model (ND rating)		FR-A820-□□K	FR-A840-□□K									
		90	90	110	132	160	185	220	280			
Rated output power (kW)		75	75	90	110	132	160	200	250			
Rated torque (N·m)		477	477	572	700	840	1018	1273	1591			
Maximum torque at 150% 60 s (N·m)		715	715	858	1050	1260	1527	1909	2386			
Rated speed (r/min)		1500										
Maximum speed (r/min)		2400	2400	1800								
Frame No.		250MD	250MD	250MD	280MD	280MD	280MD	280L	315H			
Inertia moment J (kg·m <sup>2</sup> )		1.1	1.1	1.7	2.3	2.3	4.0	3.8	5.0			
Noise		90 dB	90 dB			95 dB						
Cooling fan		Voltage							Three-phase 200 V 50 Hz / 200 V 60 Hz / 220 V 60 Hz (400 V class cooling fan is available upon order.)			
		Input (W)		50 Hz	750	400	400	400	400	400	750	750
				60 Hz		750	750	750	750	750	1500	1500
Approx. mass (kg)		610	610	660	870	890	920	1170	1630			
Common specifications		Surrounding air temperature and humidity							-10 to +40°C (non-freezing), 90% RH or less (non-condensing)			
		Structure							Totally enclosed forced ventilated			
		Equipment							Encoder, thermal protector <sup>*2</sup> , fan			
		Insulation class							F			
		Vibration rank							V10			
		Dedicated encoder		Resolution							2048 pulse/rev	
				Power supply voltage							12/24 VDC±10% <sup>*1</sup>	
				Current consumption							90 mA	
Output signal form							Phase A and Phase B: 90 degrees out of phase, Phase Z: 1 pulse/rev					
Output circuit							Complementary (constant voltage output matched by emitter follow)					
		Output voltage							"H" level: 9 V power supply voltage or more (IOH: -20 mA). "L" level: 3 V power supply voltage or less (IOL: 20 mA).			

\*1 The 12/24 V power supply is required for the encoder.

\*2 A motor with a thermal protector is available. Contact your sales representative.

### ◆ Motor torque

The torque characteristics of the SF-THY driven by the inverter are shown in graph form as follows.

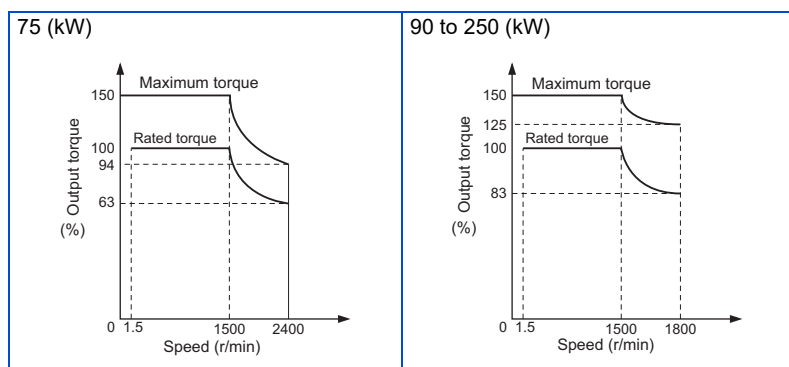

## 8.2.3 IPM motor MM-CF (2000 r/min series)

### ◆ Motor specifications

Motor model: MM-CF□		52(C)(B)	102(C)(B)	152(C)(B)	202(C)(B)	352(C)(B)	502(C)	702(C)
Applicable inverter model: FR-A820□K	SLD	0.4	0.4	0.75	1.5	2.2	3.7	5.5
	LD	0.4	0.4	0.75	1.5	2.2	3.7	5.5
	ND (initial setting)	0.4	0.75	1.5	2.2	3.7	5.5	7.5
	HD	0.75 <sup>*6</sup>	1.5 <sup>*6</sup>	2.2 <sup>*6</sup>	3.7 <sup>*6</sup>	5.5 <sup>*6</sup>	7.5 <sup>*6</sup>	11 <sup>*6</sup>
Continuous characteristics <sup>*1</sup>	Rated output power (kW)	0.5	1.0	1.5	2.0	3.5	5.0	7.0
	Rated torque (N·m)	2.39	4.78	7.16	9.55	16.70	23.86	33.41
Rated speed <sup>*1</sup> (r/min)		2000						
Maximum speed (r/min)		3000						
Instantaneous permissible speed (r/min)		3450 <sup>*7</sup>						
Maximum torque (N·m)		4.78	9.56	14.32	19.09	33.41	47.73	66.82
Inertia moment J <sup>*5</sup> (×10 <sup>-4</sup> kg m <sup>2</sup> )		6.6 (7.0)	13.7 (14.9)	20.0 (21.2)	45.5 (48.9)	85.6 (89.0)	120.0	160.0
Recommended ratio of load inertia moment to motor shaft inertia moment <sup>*2</sup>		100 times max.			50 times max.			
Rated current (A)		1.81	3.70	5.22	7.70	12.5	20.5	27.0
Insulation class		F						
Structure (Protection rating)		Totally enclosed, naturally air-cooled (IP44 <sup>*3</sup> /IP65 <sup>*3*4</sup> )						
Surrounding air temperature and humidity		-10 to +40°C (non-freezing), 90% RH or less (non-condensing)						
Storage temperature and humidity		-20 to +70°C (non-freezing), 90% RH or less (non-condensing)						
Ambience		Indoors (no direct sun light) and free from corrosive gas, flammable gas, oil mist, dust and dirt, etc.						
Altitude		Maximum 1000 m						
Vibration		X: 9.8 m/s <sup>2</sup> , Y: 24.5 m/s <sup>2</sup>						
Approx. mass <sup>*5</sup> (kg)		5.1/7.8	7.2/11	9.3/13	13/20	19/28	27	36

\*1 The rated output power or speed is not guaranteed at low supply voltages.

\*2 It is the case that the load torque is 20% of the motor rating. The permissible load inertia moment ratio is smaller when the load torque is larger. Consult us if the load inertia moment ratio exceeds the above value.

\*3 This does not apply to the shaft through portion.

\*4 The value after the slash is for MM-CF□ J2C.

\*5 The value for MM-CF□ J2B is indicated in parentheses.

\*6 The one-rank higher inverter is designated for high torque in low-speed range.

\*7 **Set 3150 r/min (210 Hz) or less in Pr.374 Overspeed detection level.** The inverter may be damaged by the motor induction voltage if the motor speed exceeds 3150 r/min (210 Hz).

## ◆ Motor torque

Motor capacity	Low speed high torque setting enabled (high frequency superposition control)	
1.5 kW or lower	<p>ND rating</p>	<p>HD rating</p>
2.0 kW or higher	<p>ND rating</p>	<p>HD rating</p> <p>* Zero speed up to a 150% instantaneous output torque</p>

Motor capacity	Low speed high torque setting disabled (current synchronization operation)
All capacities	<p>ND rating</p>

## 8.3 Common specifications

Control	Control method		Soft-PWM control, high carrier frequency PWM control (selectable among V/F control, Advanced magnetic flux vector control, Real sensorless vector control), Optimum excitation control, Vector control <sup>*1</sup> , and PM sensorless vector control
	Output frequency range		0.2 to 590 Hz (The upper-limit frequency is 400 Hz under Advanced magnetic flux vector control, Real sensorless vector control, Vector control <sup>*1</sup> , and PM sensorless vector control.)
	Frequency setting and resolution	Analog input	0.015 Hz/60 Hz at 0 to 10 V/12 bits (terminals 2 and 4). 0.03 Hz/60 Hz at 0 to 5 V/11 bits or 0 to 20 mA/approx. 11 bits (terminals 2 and 4), at 0 to ±10 V/12 bits (terminal 1). 0.06 Hz/60 Hz at 0 to ±5 V/11 bits (terminal 1).
		Digital input	0.01 Hz
	Frequency accuracy	Analog input	Within ±0.2% of the maximum output frequency (25 ± 10°C)
		Digital input	0.01% or less of the set output frequency
	Voltage/frequency characteristics		Base frequency can be set from 0 to 590 Hz. Constant-torque/variable-torque pattern or adjustable 5 points V/F can be selected.
	Starting torque <sup>*2</sup>		SLD rating: 120% 0.3 Hz, LD rating: 150% 0.3 Hz, ND rating: 200% <sup>*3</sup> 0.3 Hz, HD rating: 250% <sup>*3</sup> 0.3 Hz (under Real sensorless vector control) SLD rating: 120% 0 Hz, LD rating: 150% 0 Hz, ND rating: 200% <sup>*3</sup> 0 Hz, HD rating: 250% <sup>*3</sup> 0 Hz (under Vector control <sup>*1</sup> )
	Torque boost		Manual torque boost
	Acceleration/deceleration time setting		0 to 3600 s (acceleration and deceleration can be set individually), linear or S-pattern acceleration/ deceleration mode, backlash countermeasures acceleration/deceleration can be selected.
	DC injection brake (induction motor)		Operation frequency (0 to 120 Hz), operation time (0 to 10 s), operation voltage (0 to 30%) variable
Stall prevention operation level		Activation range of stall prevention operation (SLD rating: 0 to 120%, LD rating: 0 to 150%, ND rating: 0 to 220%, HD rating: 0 to 280%). Whether to use the stall prevention or not can be selected (V/F control, Advanced magnetic flux vector control)	
Torque limit level		Torque limit value can be set (0 to 400% variable). (Real sensorless vector control, Vector control <sup>*1</sup> , PM sensorless vector control)	
Operation	Frequency setting signal	Analog input	Terminals 2 and 4: 0 to 10 V / 0 to 5 V / 4 to 20 mA (0 to 20 mA). Terminal 1: -10 to +10 V / -5 to +5 V.
		Digital input	Input using the setting dial of the operation panel or parameter unit. Input of four-digit BCD (Binary-coded decimal) or 16-bit binary when the option FR-A8AX is installed.
	Start signal		Forward and reverse rotation or start signal automatic self-holding input (3-wire input) can be selected.
	Input signal (12)		Low-speed operation command, Middle-speed operation command, High-speed operation command, Second function selection, Terminal 4 input selection, Jog operation selection, Selection of automatic restart after instantaneous power failure / flying start, Output stop, Start self-holding selection, Forward rotation command, Reverse rotation command, Inverter reset The signal to be input can be changed using <b>Pr.178 to Pr.189 (Input terminal function selection)</b> .
	Pulse train input		100k pulses/s
	Operational function		Maximum frequency, Minimum frequency, multi-speed operation, acceleration/deceleration pattern, thermal protection, DC injection brake, Starting frequency, JOG operation, Output stop (MRS), stall prevention, regeneration avoidance, increased magnetic excitation deceleration, DC feeding <sup>*4</sup> , frequency jump, rotation indication, automatic restart after instantaneous power failure, electronic bypass sequence, remote setting, Automatic acceleration/deceleration, retry function, carrier frequency selection, fast-response current limit, forward/reverse rotation prevention, Operation mode selection, slip compensation, droop control, load torque high-speed frequency control, Speed smoothing control, traverse, auto tuning, applied motor selection, gain tuning, RS-485 communication, PID control, PID pre-charge function, dancer control, Cooling fan operation selection, Stop selection (deceleration stop/coasting), power-failure deceleration stop function, stop-on-contact control, PLC function, life diagnosis, maintenance timer, current average monitoring, multiple rating, orientation control <sup>*1</sup> , speed control, torque control, position control, pre-excitation, torque limit, test operation, 24 V power supply input for control circuit, safety stop function, anti-sway control, CC-Link IE Field Network communication <sup>*11</sup>
	Output signal	Open collector output (5) Relay output (2)	
Pulse train output (FM type inverter)		50k pulses/s	



Indication	For indication on external meters	Pulse train output (FM type inverter)	Max. 2.4 kHz via one terminal (for the indication of inverter output frequency). The item for monitoring can be changed using <b>Pr.54 FM/CA terminal function selection</b> .
		Current output (CA type inverter)	Max. 20 mADC via one terminal (for the indication of inverter output frequency). The item for monitoring can be changed using <b>Pr.54 FM/CA terminal function selection</b> .
		Voltage output	Max. 10 VDC via one terminal (for the indication of inverter output frequency). The item for monitoring can be changed using <b>Pr.158 AM terminal function selection</b> .
	Operation panel (FR-DU08)	Status monitoring	Output frequency, output current, output voltage, and frequency setting value are monitored. The item for monitoring can be changed using <b>Pr.52 Operation panel main monitor selection</b> .
		Fault monitoring	When a protective function is activated, a fault indication is displayed and the output voltage, output current, output frequency, cumulative energization time, date (year, month, day) and time at the occurrence of the fault are stored. Each fault is recorded and the last 8 records can be displayed.
Protective function	Fault	Overcurrent trip during acceleration, Overcurrent trip during constant speed, Overcurrent trip during deceleration or stop, Regenerative overvoltage trip during acceleration, Regenerative overvoltage trip during constant speed, Regenerative overvoltage trip during deceleration or stop, Inverter overload trip (electronic thermal relay function), Motor overload trip (electronic thermal relay function), Heat sink overheat, Instantaneous power failure <sup>*4</sup> , Undervoltage <sup>*4</sup> , Input phase loss <sup>*4*5</sup> , Stall prevention stop, Loss of synchronism detection <sup>*5</sup> , Brake transistor alarm detection <sup>*6</sup> , Upper limit fault detection, Lower limit fault detection, Output side earth (ground) fault overcurrent, Output short circuit, Output phase loss, External thermal relay operation <sup>*5</sup> , PTC thermistor operation <sup>*5</sup> , Option fault, Communication option fault, Parameter storage device fault (control circuit board), PU disconnection, Retry count excess <sup>*5</sup> , CPU fault, Operation panel power supply short circuit/RS-485 terminals power supply short circuit, 24 VDC power fault, Abnormal output current detection <sup>*5</sup> , Inrush current limit circuit fault <sup>*4</sup> , Communication fault (inverter), Analog input fault, USB communication fault, Safety circuit fault, Overspeed occurrence <sup>*5</sup> , Speed deviation excess detection <sup>*1*5</sup> , Signal loss detection <sup>*1*5</sup> , Excessive position fault <sup>*1*5</sup> , Brake sequence fault <sup>*5</sup> , Encoder phase fault <sup>*1*5</sup> , 4 mA input fault <sup>*5</sup> , Pre-charge fault <sup>*5</sup> , PID signal fault <sup>*5</sup> , Option fault, Opposite rotation deceleration fault <sup>*5</sup> , Internal circuit fault, Abnormal internal temperature <sup>*7</sup> , Magnetic pole position unknown <sup>*1</sup> , External fault during output operation <sup>*5</sup>	
	Alarm, warning, error message	Fan alarm, Stall prevention (overcurrent), Stall prevention (overvoltage), Regenerative brake pre-alarm <sup>*5*6</sup> , Electronic thermal relay function pre-alarm, PU stop, Speed limit indication <sup>*5</sup> , Parameter copy, Safety stop, Maintenance signal output <sup>*5</sup> , USB host error, Home position return setting error <sup>*5</sup> , Home position return uncompleted <sup>*5</sup> , Home position return parameter setting error <sup>*5</sup> , Operation panel lock <sup>*5</sup> , Password locked <sup>*5</sup> , Parameter write error, Copy operation error, 24 V external power supply operation, Internal fan alarm <sup>*7</sup> , Continuous operation during communication fault <sup>*5</sup> , Load fault warning	
Environment	Surrounding air temperature	-10 to +50°C (0 to +50°C for the FR-A800-GF) (non-freezing) (LD, ND, HD ratings). -10 to +40°C (0 to +40°C for the FR-A800-GF) (non-freezing) (SLD rating, IP55 compatible models).	
	Surrounding air humidity	95% RH or less (non-condensing) (With circuit board coating (conforming to IEC 60721-3-3 3C2/3S2), IP55 compatible models). 90% RH or less (non-condensing) (Without circuit board coating).	
	Storage temperature <sup>*8</sup>	-20 to +65°C	
	Ambience	Indoors (free from corrosive gas, flammable gas, oil mist, dust and dirt)	
	Altitude/vibration	Maximum 2500 m <sup>*9</sup> , 5.9 m/s <sup>2</sup> or less <sup>*10</sup> at 10 to 55 Hz (directions of X, Y, Z axes)	

\*1 Available when a Vector control compatible option is installed.

\*2 For PM sensorless vector control, refer to [page 863](#).

\*3 For the FR-A820-00340(5.5K) or higher and the FR-A840-00170(5.5K) or higher, the starting torque is initially limited to a level of 150% due to the torque limitation.

\*4 The function is available for standard structure models and IP55 compatible models.

\*5 Not activated in the inverter in the initial state.

\*6 Available only for the standard model.

\*7 Available only for the IP55 compatible model.

\*8 Applicable to conditions for a short time, for example, in transit.

\*9 For the installation at an altitude above 1000 m, consider a 3% reduction in the rated current per 500 m increase in altitude.

\*10 2.9 m/s<sup>2</sup> or less for the FR-A840-04320(160K) or higher.

\*11 Available only for the FR-A800-GF series.

## 8.4 Outline dimension drawings

### 8.4.1 Inverter outline dimension drawings

FR-A820-00046(0.4K), FR-A820-00077(0.75K)(-GF)

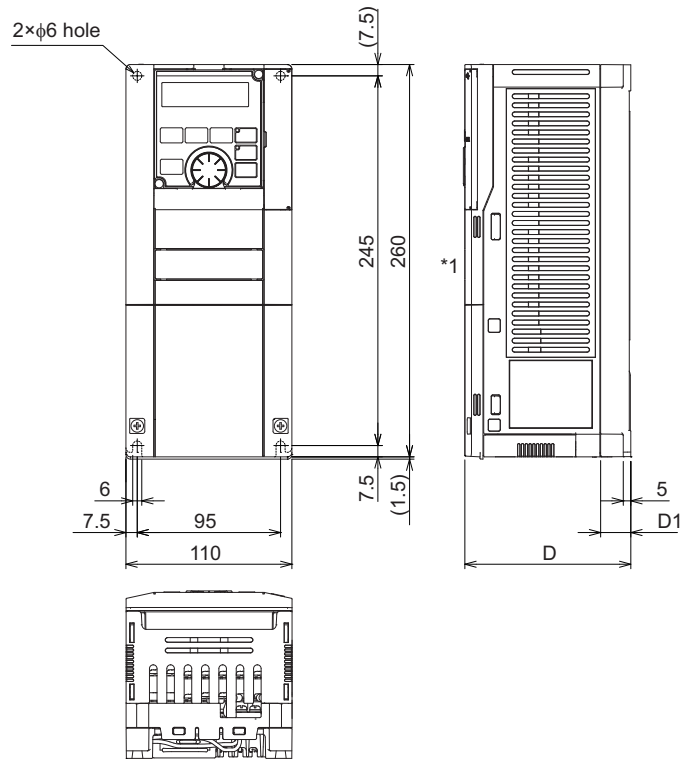

Inverter model	D	D1
FR-A820-00046(0.4K)	110	20
FR-A820-00077(0.75K)	125	35

\*1 The LED display cover attached to the FR-A800-GF in this position has an additional 2.1 mm depth.

(Unit: mm)

FR-A820-00105(1.5K), 00167(2.2K), 00250(3.7K)(-GF)

FR-A840-00023(0.4K), 00038(0.75K), 00052(1.5K), 00083(2.2K), 00126(3.7K)(-GF)

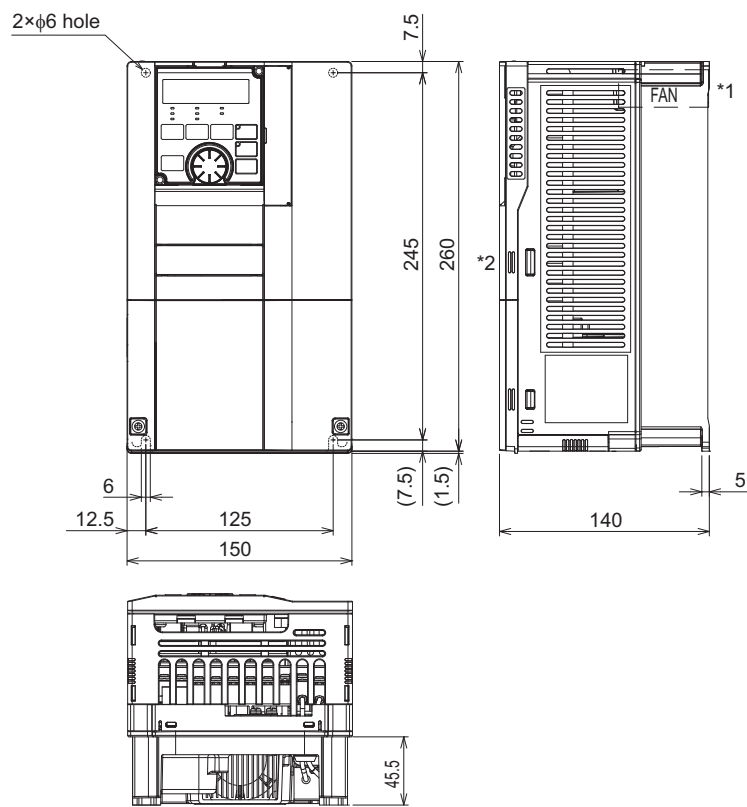

\*1 FR-A840-00023(0.4K) to 00052(1.5K) are not provided with a cooling fan.

\*2 The LED display cover attached to the FR-A800-GF in this position has an additional 2.1 mm depth.

(Unit: mm)

FR-A820-00340(5.5K), 00490(7.5K), 00630(11K)(-GF)  
 FR-A840-00170(5.5K), 00250(7.5K), 00310(11K), 00380(15K)(-GF)

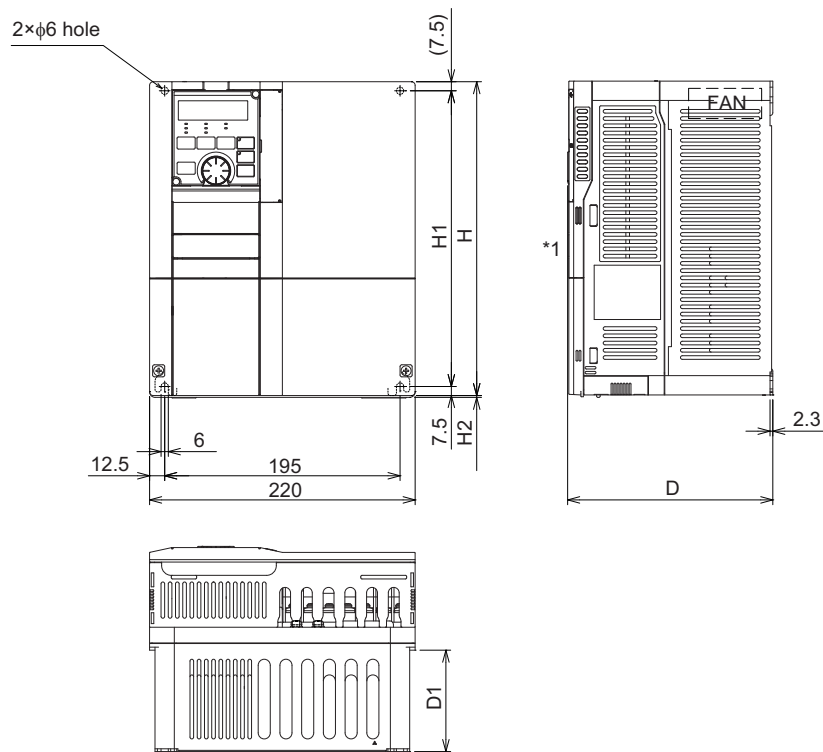

Inverter model	H	H1	H2	D	D1
FR-A820-00340(5.5K), 00490(7.5K) FR-A840-00170(5.5K), 00250(7.5K)	260	245	1.5	170	84
FR-A820-00630(11K) FR-A840-00310(11K), 00380(15K)	300	285	3	190	101.5

\*1 The LED display cover attached to the FR-A800-GF in this position has an additional 2.1 mm depth.

(Unit: mm)

FR-A820-00770(15K), 00930(18.5K), 01250(22K)(-GF)  
 FR-A840-00470(18.5K), 00620(22K)(-GF)

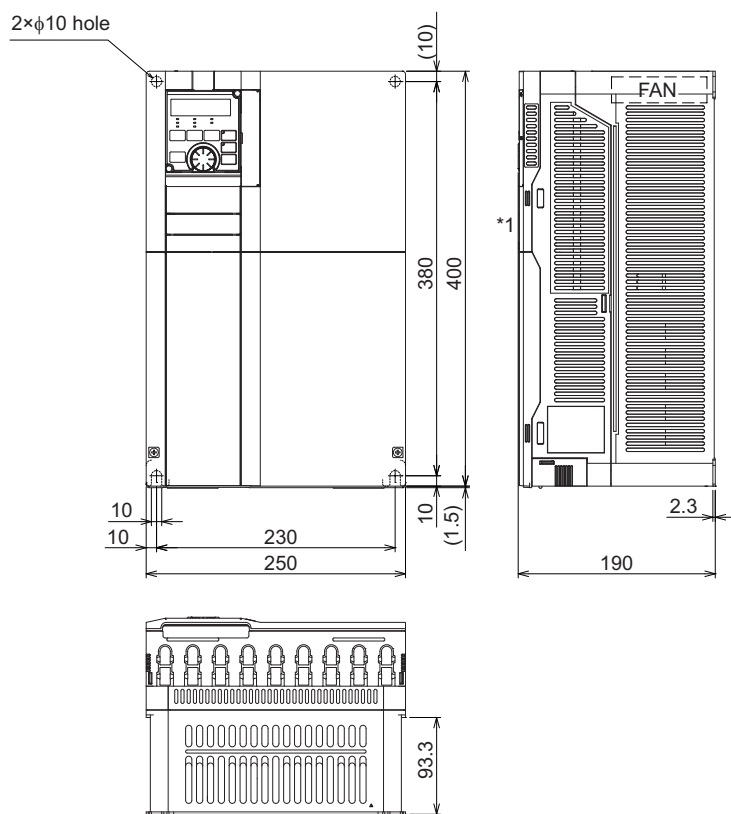

\*1 The LED display cover attached to the FR-A800-GF in this position has an additional 2.1 mm depth.

(Unit: mm)

FR-A820-01540(30K)(-GF)

FR-A840-00770(30K)(-GF)

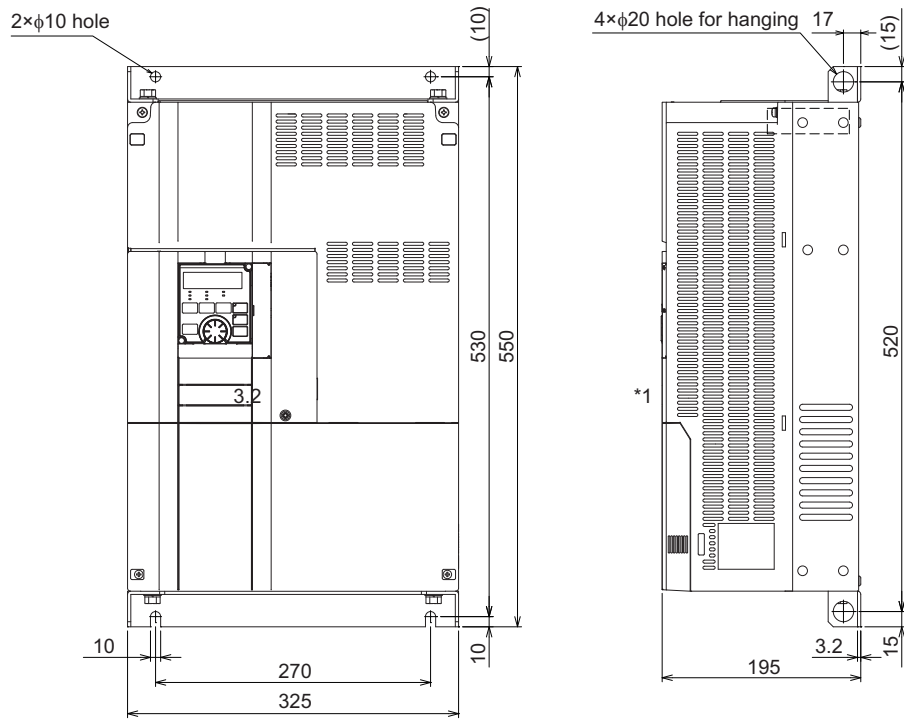

\*1 The LED display cover attached to the FR-A800-GF in this position has an additional 2.1 mm depth.

(Unit: mm)

FR-A820-01870(37K), 02330(45K), 03160(55K), 03800(75K), 04750(90K)(-GF)

FR-A840-00930(37K), 01160(45K), 01800(55K), 02160(75K), 02600(90K), 03250(110K), 03610(132K)(-GF)

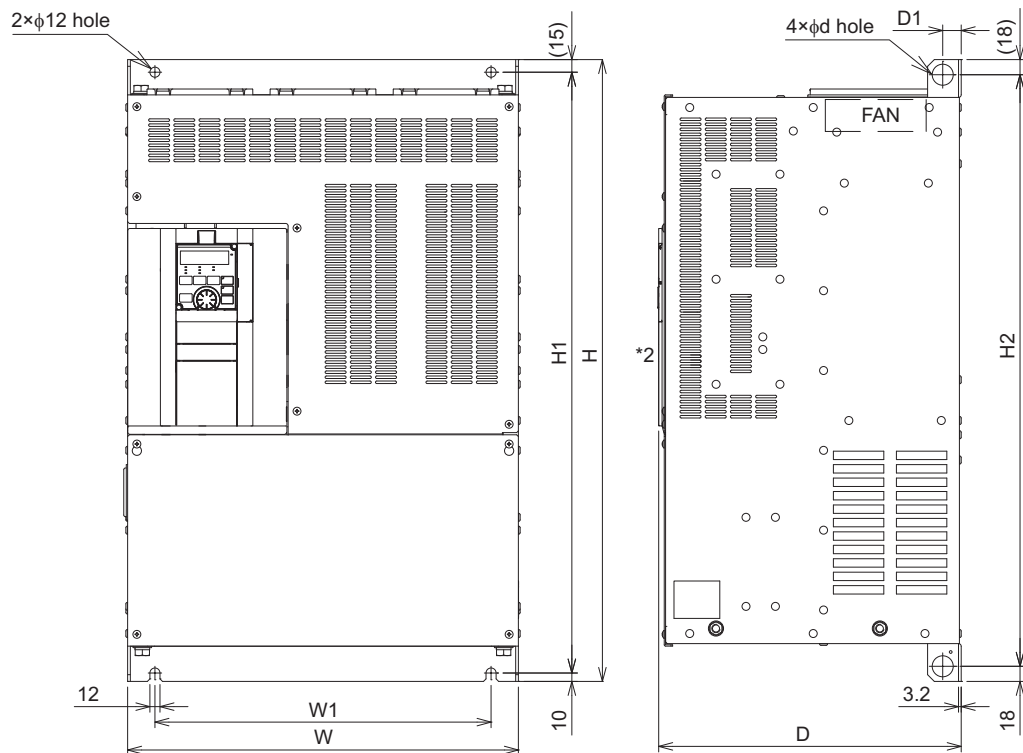

Inverter model	W	W1	H	H1	H2	d	D	D1
FR-A820-01870(37K), 02330(45K) FR-A840-00930(37K), 01160(45K), 01800(55K) <sup>*1</sup>	435	380	550	525	514	25	250	24
FR-A820-03160(55K) <sup>*1</sup>	465	410	700	675	664	25	250	22
FR-A820-03800(75K) <sup>*1</sup> , 04750(90K) <sup>*1</sup>	465	400	740	715	704	24	360	22
FR-A840-02160(75K) <sup>*1</sup> , 02600(90K) <sup>*1</sup>	465	400	620	595	584	24	300	22
FR-A840-03250(110K) <sup>*1</sup> , 03610(132K) <sup>*1</sup>	465	400	740	715	704	25	360	22

\*1 For the FR-A820-03800(75K) or higher, the FR-A840-02160(75K) or higher, or whenever a 75 kW or higher motor is used, always connect a DC reactor (FR-HEL), which is available as an option.

\*2 The LED display cover attached to the FR-A800-GF in this position has an additional 2.1 mm depth.

(Unit: mm)

FR-A840-04320(160K), 04810(185K)(-GF)

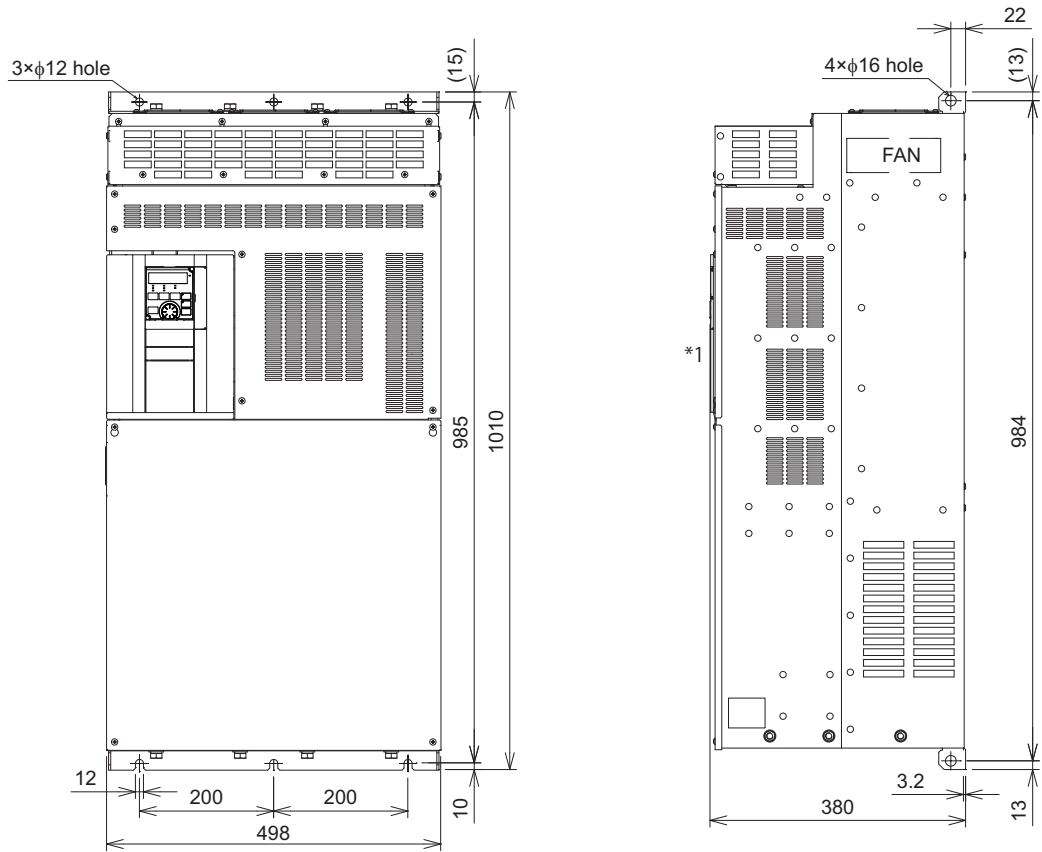

Always connect a DC reactor (FR-HEL), which is available as an option.

\*1 The LED display cover attached to the FR-A800-GF in this position has an additional 2.1 mm depth.

(Unit: mm)



FR-A840-05470(220K), 06100(250K), 06830(280K)(-GF)

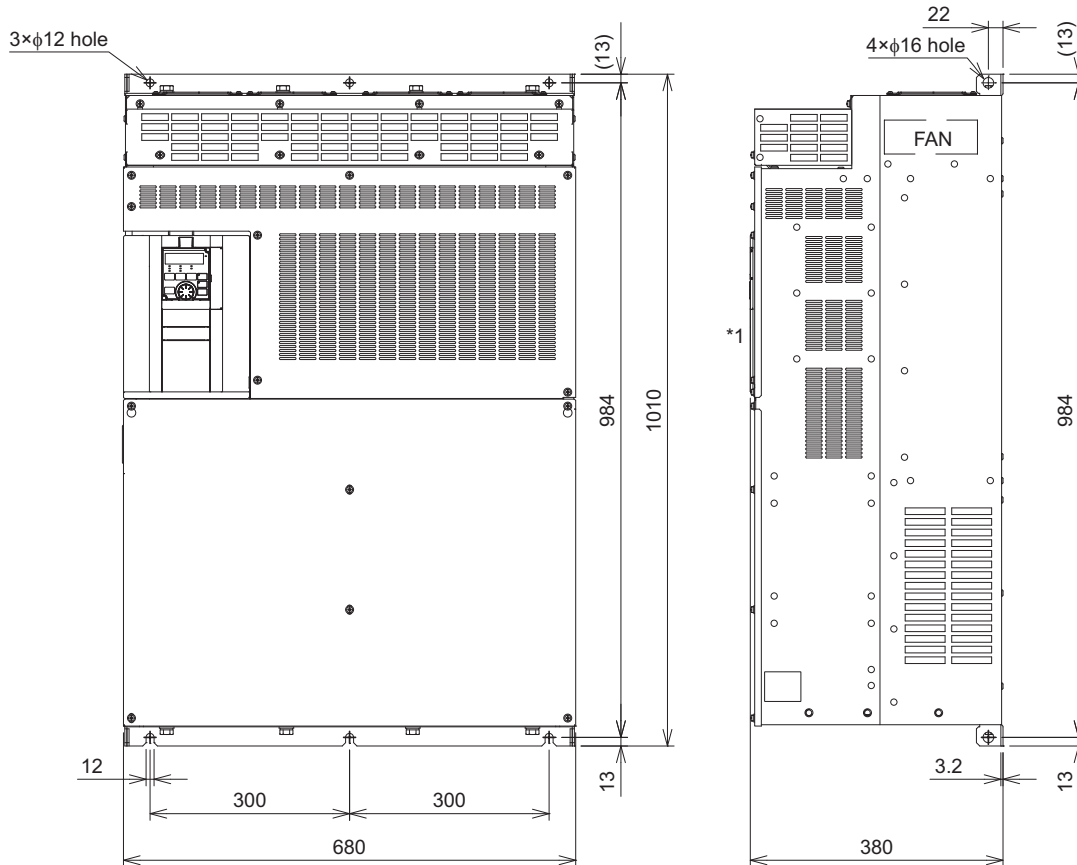

Always connect a DC reactor (FR-HEL), which is available as an option.

\*1 The LED display cover attached to the FR-A800-GF in this position has an additional 2.1 mm depth.

(Unit: mm)

Operation panel (FR-DU08, FR-LU08)

Outline drawing

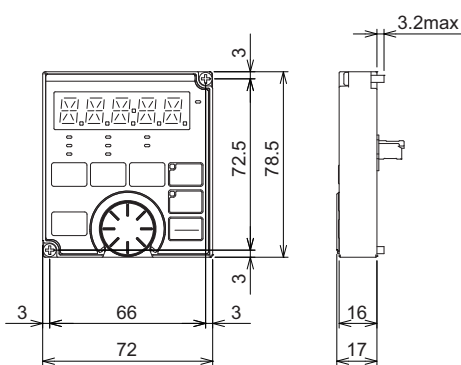

Panel cutting dimension drawing

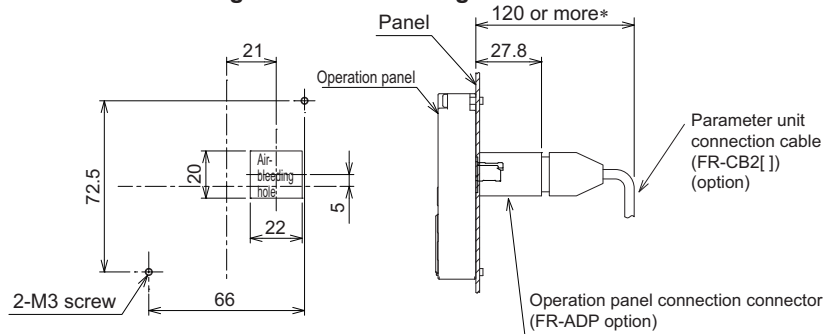

\* Denotes the space required to connect an optional parameter unit connection cable (FR-CB2[ ]). When using another cable, leave the space required for the cable specification.

(Unit: mm)

## 8.4.2 Dedicated motor outline dimension drawings

### ◆ Dedicated motor (SF-V5RU(H)) outline dimension drawings (standard horizontal type)

Frame number: 90L

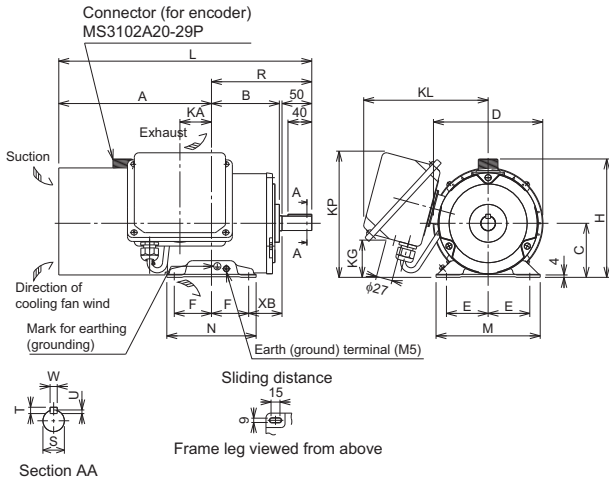

Frame number: 100L, 112M, 132S, 132M

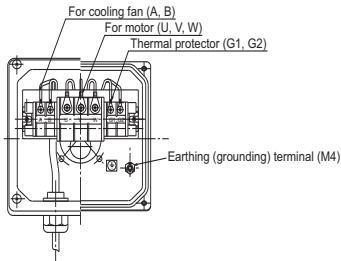
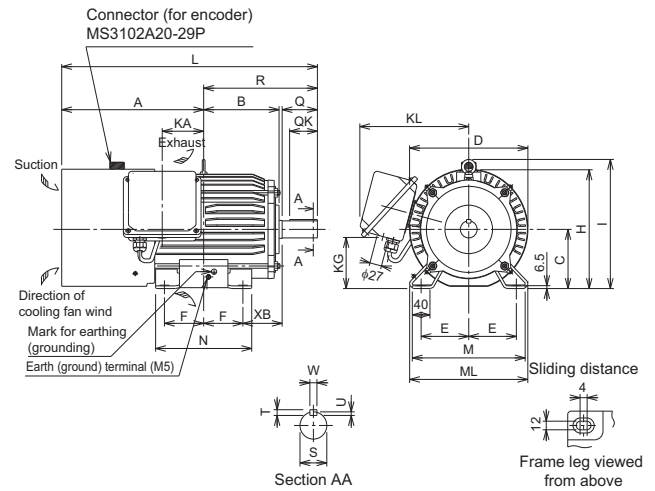

Make sure to earth the earth terminal of the flange section as well as the earth terminal in the terminal box.

8

Dimensions table (Unit: mm)

SF-V5RU □K	SF-V5RU □K1	SF-V5RU □K3	SF-V5RU □K4	Frame No.	Mass (kg)	Motor																			Terminal screw size						
						A	B	C	D	E	F	H	I	KA	KG	KL (KP)	L	M	ML	N	XB	Q	QK	R	S	T	U	W	U, V, W	A, B, (C)	G1, G2
1	—	—	—	90L	24	256.5	114	90	183.6	70	62.5	198	—	53	65	220 (210)	425	175	—	150	56	—	—	168.5	24j6	7	4	8	M6	M4	M4
2	1	—	—	100L	33	284	128	100	207	80	70	203.5	230	65	78	231	477	200	212	180	63	60	45	193	28j6	7	4	8	M6	M4	M4
3	2	1	—	112M	41	278	135	112	228	95	70	226	253	69	93	242	478	230	242	180	70	60	45	200	28j6	7	4	8	M6	M4	M4
5	3	2	—	132S	52	303	152	132	266	108	70	265	288	75	117	256	542	256	268	180	89	80	63	239	38k6	8	5	10	M6	M4	M4
7	5	3	1	132M	62	322	171	132	266	108	89	265	288	94	117	256	580	256	268	218	89	80	63	258	38k6	8	5	10	M6	M4	M4

**Frame Number: 160M, 160L, 180M, 180L**

**Frame number: 200L, 225S**

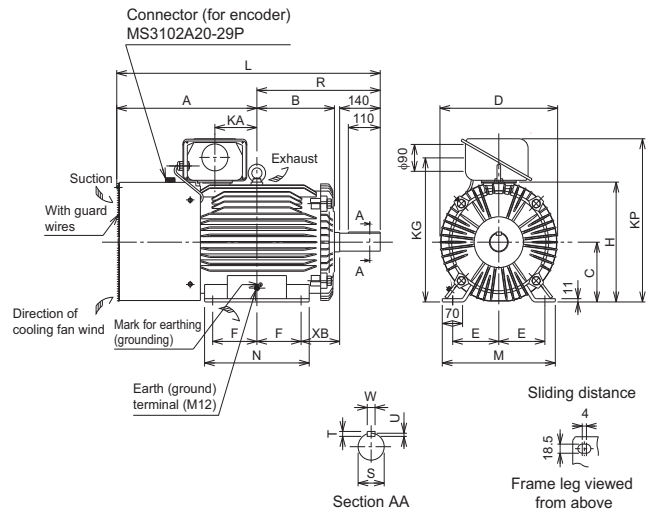
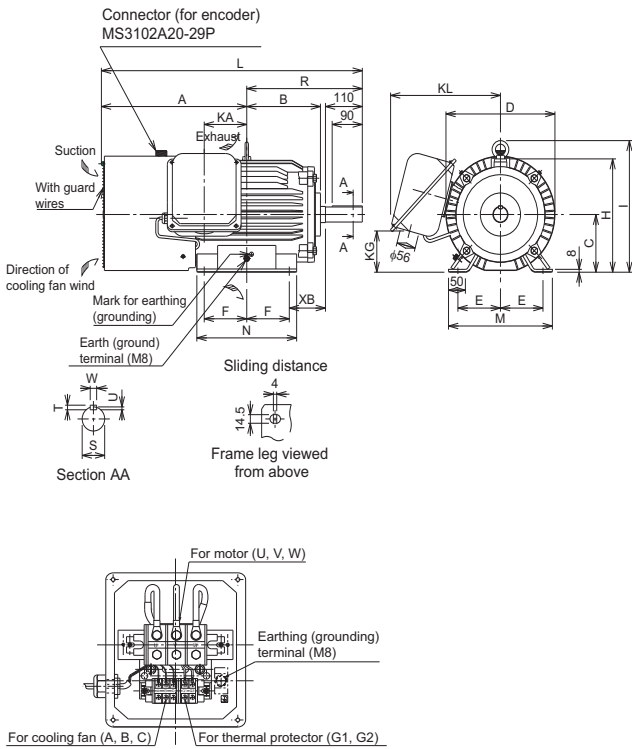

Make sure to earth the earth terminal of the flange section as well as the earth terminal in the terminal box.

**Dimensions table (Unit: mm)**

SF-V5RU [K]	SF-V5RU [K1]	SF-V5RU [K3]	SF-V5RU [K4]	Frame No.	Mass (kg)	Motor																	Terminal screw size								
						A	B	C	D	E	F	H	I	KA	KG	KL (KP)	L	M	ML	N	XB	Q	QK	R	S	T	U	W	U, V, W	A, B, (C)	G1, G2
11	7	5	2	160M	99	412	198	160	318	127	105	316	367	105	115	330	735	310	—	254	108	—	—	323	42k6	8	5	12	M8	M4	M4
15	11	7	3	160L	113	434	220	160	318	127	127	316	367	127	115	330	779	310	—	298	108	—	—	345	42k6	8	5	12	M8	M4	M4
18	—	—	—	180M	138	438.5	225.5	180	363	139.5	120.5	359	410	127	139	352	790	335	—	285	121	—	—	351.5	48k6	9	5.5	14	M8	M4	M4
22	15	11	—		160																										
—	18	15	5	180L	200	457.5	242.5	180	363	139.5	139.5	359	410	146	139	352	828	335	—	323	121	—	—	370.5	55m6	10	6	16	M8	M4	M4
30	—	—	7	200L	238	483.5	267.5	200	406	159	152.5	401	—	145	487	(546)	909	390	—	361	133	—	—	425.5	60m6	11	7	18	M10	M4	M4
37, 45	22, 30	18, 22	—		255																										
55	37	30	11, 15	225S	320	500	277	225	446	178	143	446	—	145	533	(592)	932	428	—	342	149	—	—	432	65m6	11	7	18	M10	M4	M4

**NOTE**

- Install the motor with a frame number 180 or larger on the floor and use it with the shaft horizontal.
- Leave an enough clearance between the fan suction port and wall to ensure adequate cooling. Check that a fan blows air from the opposite load side to the load side.
- The vertical tolerance for the shaft center height is  $0_{-0.5}$ .
- The 400 V class motor has "-H" at the end of its model name.

# ◆ Dedicated motor (SF-V5RU(H)) outline dimension drawings (standard horizontal type with brake)

Frame number: 90L

Frame number: 100L, 112M, 132S, 132M

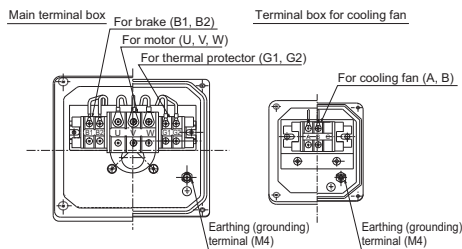
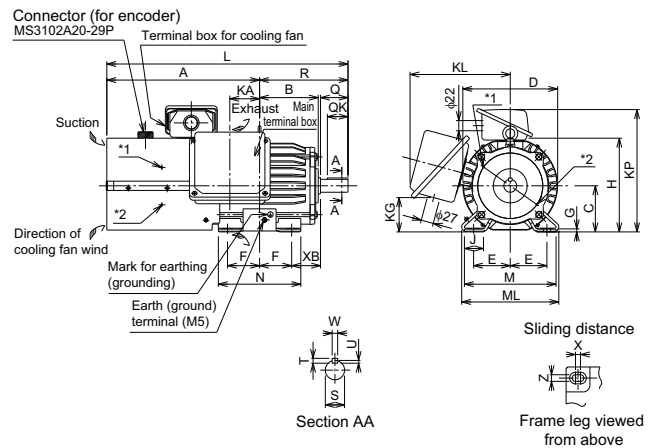
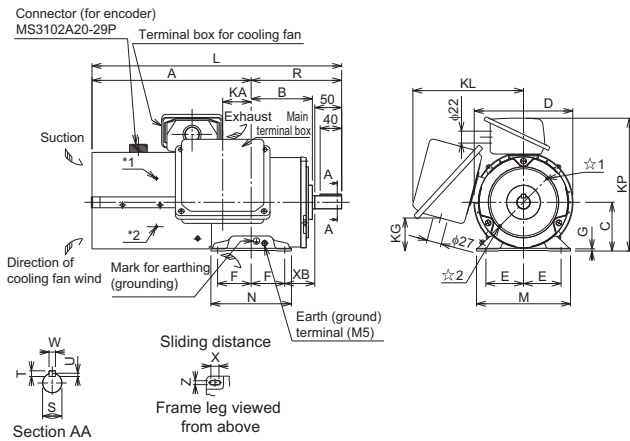

\* indicates an inserting position of a bolt with hex head holes for manual opening.  
Make sure to earth the earth terminal of the flange section as well as the earth terminal in the terminal box.

Dimensions table (Unit: mm)

SF-V5RU [K]B	SF-V5RU [K]1B	SF-V5RU [K]3B	SF-V5RU [K]4B	Frame No.	Mass (kg)	Motor																	Shaft end							Terminal screw size							
						A	B	C	D	E	F	G	H	I	J	KA	KD	KG	KL	KP	L	M	ML	N	X	XB	Z	Q	QK	R	S	T	U	W	U, V, W (C)	G1, G2	B1, B2
1	—	—	—	90L	29	296.5	114	90	183.6	70	62.5	4	—	—	53	27	65	220	245	465	175	—	150	15	56	9	50	40	168.5	24j6	7	4	8	M6	M4	M4	M4
2	1	—	—	100L	46	333.5	128	100	207	80	70	6.5	—	40	65	27	78	231	265	526.5	200	212	180	4	63	12	60	45	193	28j6	7	4	8	M6	M4	M4	M4
3	2	1	—	112M	53	355	135	112	228	95	70	6.5	—	40	69	27	93	242	290	555	230	242	180	4	70	12	60	45	200	28j6	7	4	8	M6	M4	M4	M4
5	3	2	—	132S	70	416	152	132	266	108	70	6.5	—	40	75	27	117	256	329	655	256	268	180	4	89	12	80	63	239	38k6	8	5	10	M6	M4	M4	M4
7	5	3	1	132M	80	435	171	132	266	108	89	6.5	—	40	94	27	117	256	329	693	256	268	218	4	89	12	80	63	258	38k6	8	5	10	M6	M4	M4	M4

**Frame Number: 160M, 160L, 180M, 180L**

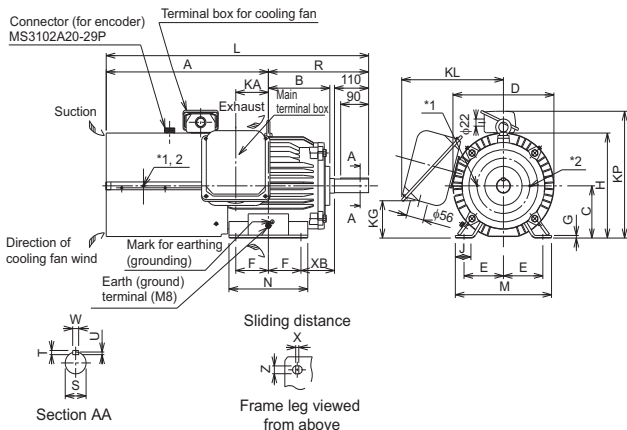

**Frame number: 200L, 225S**

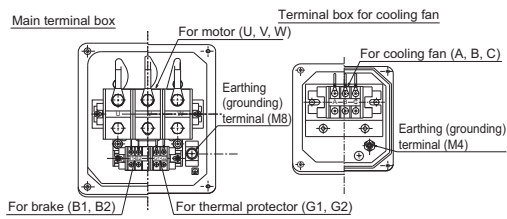
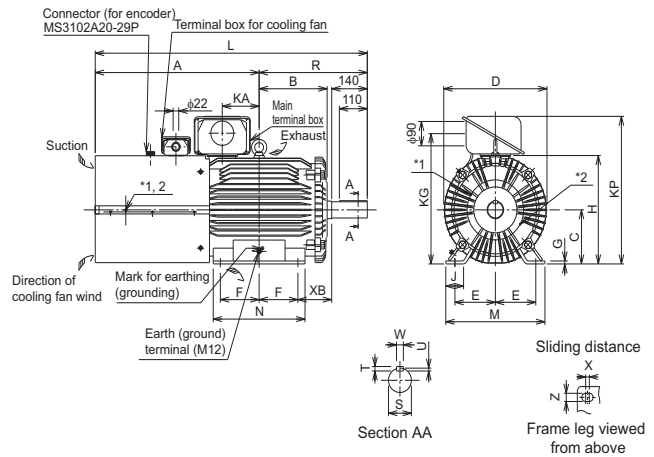

\* indicates an inserting position of a bolt with hex head holes for manual opening.  
Make sure to earth the earth terminal of the flange section as well as the earth terminal in the terminal box.

**Dimensions table (Unit: mm)**

SF-V5RU □KB	SF-V5RU □K1B	SF-V5RU □K3B	SF-V5RU □K4B	Frame No.	Mass (kg)	Motor																Shaft end						Terminal screw size									
						A	B	C	D	E	F	G	H	I	J	KA	KD	KG	KL	KP	L	M	ML	N	X	XB	Z	Q	QK	R	S	T	U	W	U, V, W	A, B, (C)	G1, G2
11	7	5	2	160M	140	522.5	198	160	318	127	105	8	—	50	105	56	115	330	391	845.5	310	—	254	4	108	14.5	110	90	323	42k6	8	5	12	M8	M4	M4	M4
15	11	7	3	160L	155	544.5	220	160	318	127	127	8	—	50	127	56	115	330	391	889.5	310	—	298	4	108	14.5	110	90	345	42k6	8	5	12	M8	M4	M4	M4
18	—	—	—	180M	185	568.5	225.5	180	363	139.5	120.5	8	—	50	127	56	139	352	428	920	335	—	285	4	121	14.5	110	90	351.5	48k6	9	5.5	14	M8	M4	M4	M4
—	18	15	5	180L	255	587.5	242.5	180	363	139.5	139.5	8	—	50	146	56	139	352	428	958	335	—	323	4	121	14.5	110	90	370.5	55m6	10	6	16	M8	M4	M4	M4
30	—	—	7	200L	305	644.5	267.5	200	406	159	152.5	11	—	70	145	90	487	—	546	1070	390	—	361	4	133	18.5	140	110	425.5	60m6	11	7	18	M10	M4	M4	M4
37, 45, 22, 30	18, 22	—	—	200L	330	644.5	267.5	200	406	159	152.5	11	—	70	145	90	487	—	546	1070	390	—	361	4	133	18.5	140	110	425.5	60m6	11	7	18	M10	M4	M4	M4
55	37	30	11, 15	225S	395	659	277	225	446	178	143	11	—	70	145	90	533	—	592	1091	428	—	342	4	149	18.5	140	110	432	65m6	11	7	18	M10	M4	M4	M4

**NOTE**

- Install the motor on the floor and use it with the shaft horizontal.
- Leave an enough clearance between the fan suction port and wall to ensure adequate cooling. Check that a fan blows air from the opposite load side to the load side.
- The vertical tolerance for the shaft center height is  $0_{-0.5}$ .
- The 400 V class motor has "-H" at the end of its model name.
- Since a brake power device is a stand-alone, install it inside the enclosure. (This device should be arranged by the customer. Refer to the FR-A800 catalog.)

# ◆ Dedicated motor (SF-V5RU(H)) outline dimension drawings (flange type)

Frame number: 90L

Frame number: 100L, 112M, 132S, 132M

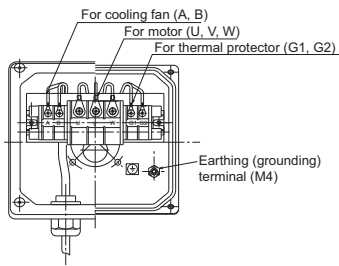
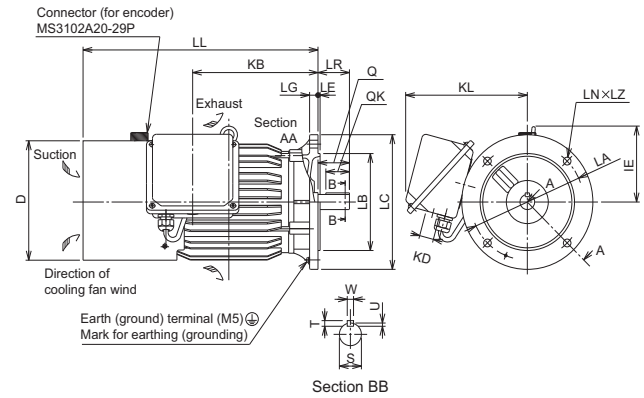
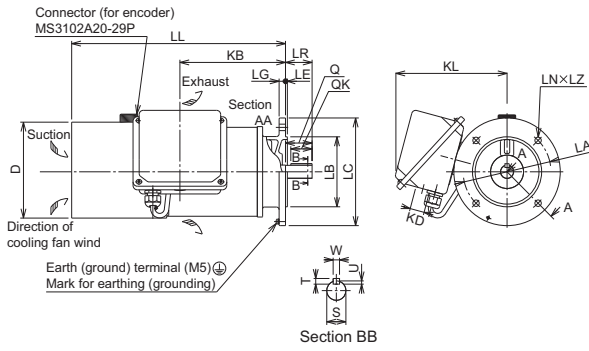

Make sure to earth the earth terminal of the flange section as well as the earth terminal in the terminal box.

Dimensions table (Unit: mm)

SF-V5RU(H) [K]	SF-V5RU(H) [K1]	SF-V5RU(H) [K3]	SF-V5RU(H) [K4]	Flange No.	Frame No.	Mass (kg)	Motor												Shaft end						Terminal screw size				
							D	IE	KB	KD	KL	LA	LB	LC	LE	LG	LL	LN	LZ	LR	Q	QK	S	T	U	W	U, V, W (C)	A, B, (C)	G1, G2
1	—	—	—	FF165	90L	26.5	183.6	—	198.5	27	220	165	130j6	200	3.5	12	402	4	12	50	50	40	24j6	7	4	8	M6	M4	M4
2	1	—	—	FF215	100L	37	207	130	213	27	231	215	180j6	250	4	16	432	4	14.5	60	60	45	28j6	7	4	8	M6	M4	M4
3	2	1	—	FF215	112M	46	228	141	239	27	242	215	180j6	250	4	16	448	4	14.5	60	60	45	28j6	7	4	8	M6	M4	M4
5	3	2	—	FF265	132S	65	266	156	256	27	256	265	230j6	300	4	20	484	4	14.5	80	80	63	38k6	8	5	10	M6	M4	M4
7	5	3	1	FF265	132M	70	266	156	294	27	256	265	230j6	300	4	20	522	4	14.5	80	80	63	38k6	8	5	10	M6	M4	M4



# ◆ Dedicated motor (SF-V5RU(H)) outline dimension drawings (flange type with brake)

Frame number: 90L

Frame number: 100L, 112M, 132S, 132M

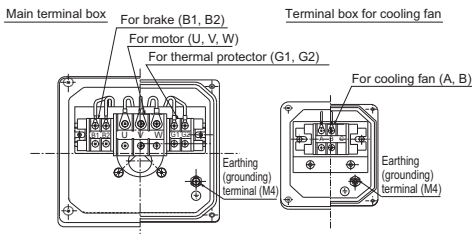
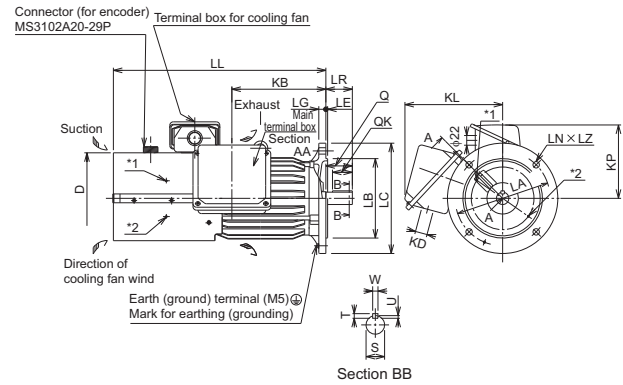
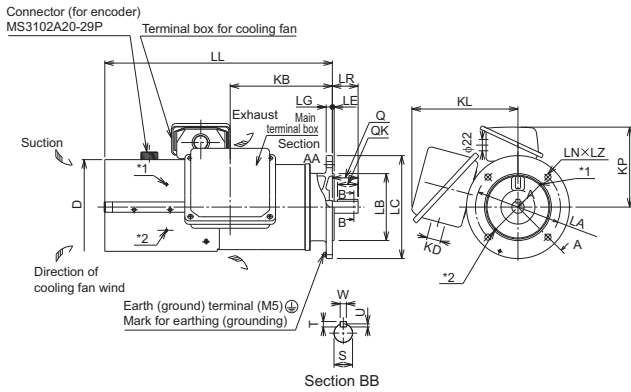

\* indicates an inserting position of a bolt with hex head holes for manual opening.

Make sure to earth the earth terminal of the flange section as well as the earth terminal in the terminal box.

Dimensions table (Unit: mm)

SF-V5RUF [KB]	SF-V5RUF [K1B]	SF-V5RUF [K3B]	SF-V5RUF [K4B]	Flange No.	Frame No.	Mass (kg)	Motor																Shaft end					Terminal screw size			
							D	KB	KD	KL	KP	LA	LB	LC	LE	LG	LL	LN	LZ	LR	Q	QK	S	T	U	W	U, V, W	A, B, (C)	B1, B2	G1, G2	
1	—	—	—	FF165	90L	31.5	183.6	198.5	27	220	155	165	130j6	200	3.5	12	442	4	12	50	50	40	24j6	7	4	8	M6	M4	M4	M4	
2	1	—	—	FF215	100L	50	207	213	27	231	165	215	180j6	250	4	16	481.5	4	14.5	60	60	45	28j6	7	4	8	M6	M4	M4	M4	
3	2	1	—	FF215	112M	58	228	239	27	242	178	215	180j6	250	4	16	525	4	14.5	60	60	45	28j6	7	4	8	M6	M4	M4	M4	
5	3	2	—	FF265	132S	83	266	256	27	256	197	265	230j6	300	4	20	597	4	14.5	80	80	63	38k6	8	5	10	M6	M4	M4	M4	
7	5	3	1	FF265	132M	88	266	294	27	256	197	265	230j6	300	4	20	635	4	14.5	80	80	63	38k6	8	5	10	M6	M4	M4	M4	



Frame number: 160M, 160L

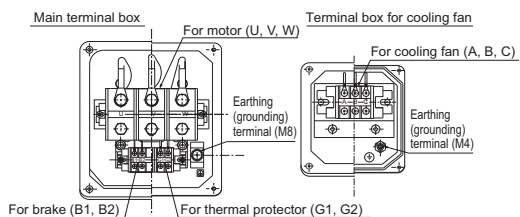
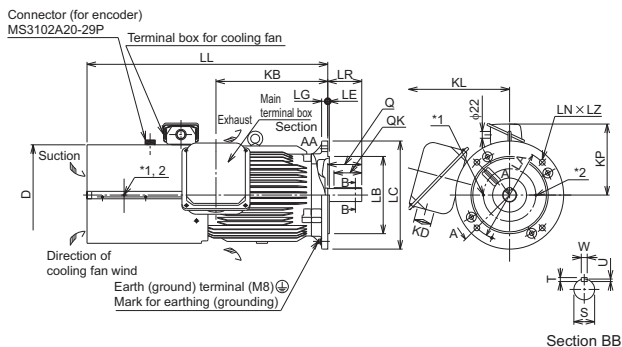

\* indicates an inserting position of a bolt with hex head holes for manual opening.  
 Make sure to earth the earth terminal of the flange section as well as the earth terminal in the terminal box.

Dimensions table (Unit: mm)

SF- V5RUF □KB	SF- V5RUF □K1B	SF- V5RUF □K3B	SF- V5RUF □K4B	Flange No.	Frame No.	Mass (kg)	Motor													Shaft end						Terminal screw size				
							D	KB	KD	KL	KP	LA	LB	LC	LE	LG	LL	LN	LZ	LR	Q	QK	S	T	U	W	U, V, W	A, B, (C)	B1, B2	G1, G2
11	7	5	2	FF300	160M	151	318	318	56	330	231	300	250j6	350	5	20	735.5	4	18.5	110	110	90	42k6	8	5	12	M8	M4	M4	M4
15	11	7	3	FF300	160L	167	318	362	56	330	231	300	250j6	350	5	20	779.5	4	18.5	110	110	90	42k6	8	5	12	M8	M4	M4	M4

**NOTE**

- Install the motor on the wall and use it with the shaft horizontal.
- Leave an enough clearance between the fan suction port and wall to ensure adequate cooling. Check that a fan blows air from the opposite load side to the load side.
- The 400 V class motor has "-H" at the end of its model name.
- Since a brake power device is a stand-alone, install it inside the enclosure. (This device should be arranged by the customer. Refer to the FR-A800 catalog.)

# ◆ Dedicated motor (SF-THY) outline dimension drawings (1500 r/min series)

Frame number: 250MD, 280MD

75 to 160 kW

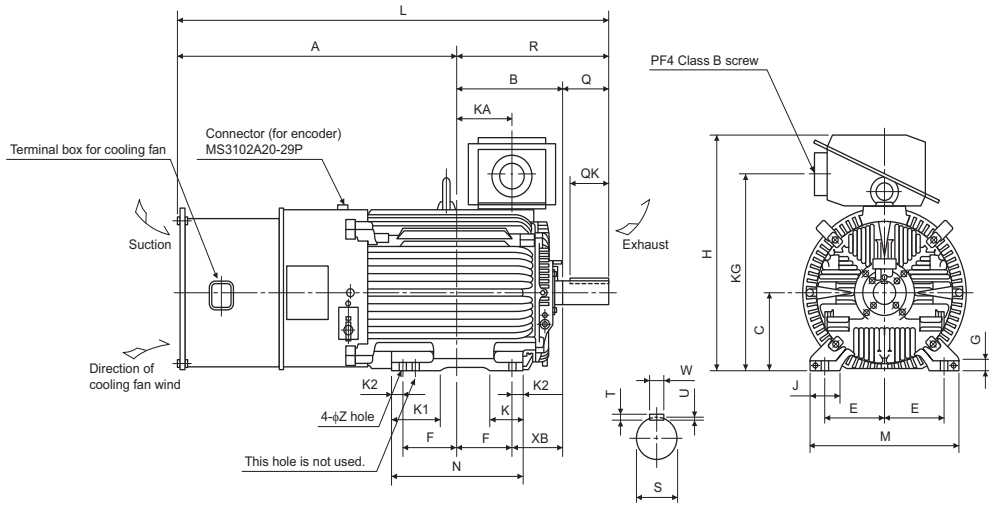

Frame number: 280L, 315H

200 kW, 250 kW

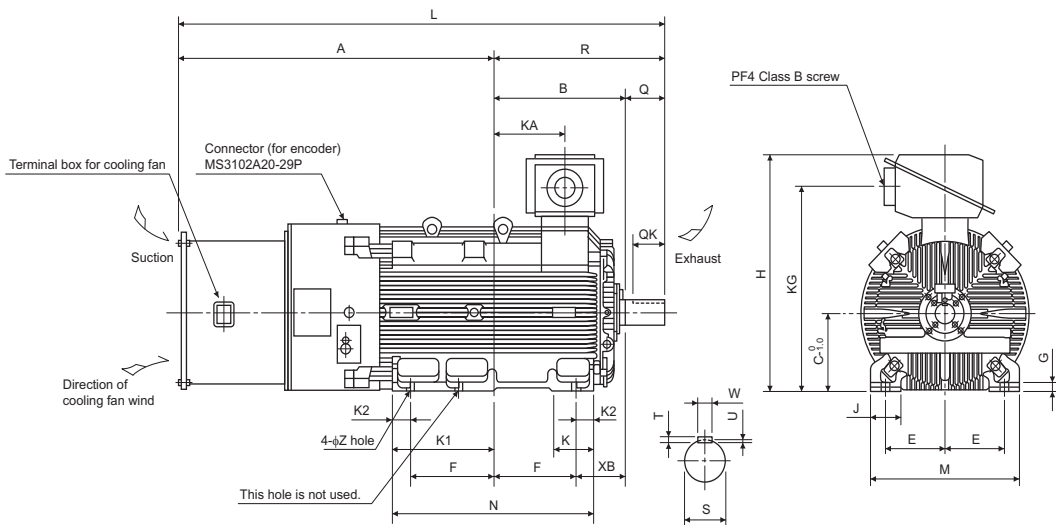

Dimensions table (Unit: mm)

Output	Frame No.	Mass (kg)	Motor																		Shaft end size							
			A	B	C	D	E	F	G	H	J	K	K1	K2	L	M	N	R	Z	XB	KA	KG	Q	QK	S	W	T	U
75	250MD	610	988.5	340.5	250	557	203	174.5	30	775	100	130	168	50	1471	486	449	482.5	24	168	157.5	635	140	110	φ75m6	20	12	7.5
90	250MD	660	988.5	340.5	250	557	203	174.5	30	775	100	130	168	50	1471	486	449	482.5	24	168	157.5	635	140	110	φ75m6	20	12	7.5
110	280MD	870	1049.5	397.5	280	607	228.5	209.5	30	845	110	130	181	40	1619	560	449	569.5	24	190	210.5	705	170	140	φ85m6	22	14	9
132	280MD	890	1049.5	397.5	280	607	228.5	209.5	30	845	110	130	181	40	1619	560	449	569.5	24	190	210.5	705	170	140	φ85m6	22	14	9
160	280MD	920	1049.5	397.5	280	607	228.5	209.5	30	845	110	130	181	40	1619	560	499	569.5	24	190	210.5	705	170	140	φ85m6	22	14	9
200	280L	1170	1210.5	416.5	280	652	228.5	228.5	30	885	110	160	160	75	1799	560	607	588.5	24	190	214.5	745	170	140	φ85m6	22	14	9
250	315H	1630	1343	565	315	717	254	355	35	965	130	175	428	80	2084	636	870	741	28	216	306	825	170	140	φ95m6	25	14	9

## NOTE

- The vertical tolerance for the shaft center height C is  $0_{-0.5}$  for the frame number 250, and  $0_{-1.0}$  for the frame number 280 or larger.

# MEMO

# CHAPTER 9 APPENDIX

9.1	For customers replacing the conventional model with this inverter .....	856
9.2	International standards .....	858
9.3	Acquisition of type certification for ship classification standards (400 V class) .....	858
9.4	Specification comparison between PM sensorless vector control and induction motor control.....	863
9.5	Parameters (functions) and instruction codes under different control methods.....	864
9.6	For customers using HMS network options .....	893
9.7	Ready bit status selection (Pr.349, N240) .....	897

# 9 APPENDIX

APPENDIX provides the reference information for use of this product.

Refer to APPENDIX as required.

## 9.1 For customers replacing the conventional model with this inverter

### 9.1.1 Replacement of the FR-A700 series

#### ◆ Differences and compatibility with the FR-A700 series

Item	FR-A700	FR-A800
<b>Control method</b>	V/F control Advanced magnetic flux vector control Real sensorless vector control Vector control (with plug-in option) PM sensorless vector control (IPM motor)	V/F control Advanced magnetic flux vector control Real sensorless vector control Vector control (with plug-in option / control terminal option) PM sensorless vector control (IPM motor / SPM motor)
<b>Added functions</b>	—	USB host function, safety stop function, etc.
<b>Brake transistor (brake resistor usable)</b>	Built in for the FR-A720-0.4K to 22K. Built in for the FR-A740-0.4K to 22K.	Built in for the FR-A820-00046(0.4K) to 01250(22K). Built in for the FR-A840-00023(0.4K) to 01800(55K).
<b>Maximum output frequency</b>	<b>V/F control</b>	400 Hz
	<b>Advanced magnetic flux vector control</b>	120 Hz
	<b>Real sensorless vector control</b>	120 Hz
	<b>Vector control</b>	120 Hz
	<b>PM sensorless vector control</b>	300 Hz
<b>PID control</b>	Turn the X14 signal ON to enable PID control.	When the X14 signal is not assigned, just set a value in <b>Pr.128</b> to enable PID control. When the X14 signal is assigned, turn the X14 signal ON while <b>Pr.128</b> ≠ "0" to enable PID control. The PID pre-charge function and dancer control are added.
<b>Automatic restart after instantaneous power failure</b>	Turn the CS signal ON to enable restart.	Restart is enabled by turning ON the CS signal, or solely setting <b>Pr.57</b> if the CS signal is not assigned to any input terminal.
<b>Restart coasting time after instantaneous power failure</b>	Time period from restoration of power until the operation is restarted	Time period from occurrence of instantaneous power failure until the operation is restarted
<b>Number of motor poles V/F control switching</b>	The V/F switchover (X18) signal is valid when <b>Pr.81</b> = "12 to 20" (2 to 10 poles).	<b>Pr.81</b> = "12" (12 poles) The X18 signal is valid regardless of the <b>Pr.81</b> setting. (The <b>Pr.81</b> settings "14 to 20" are not available.)
<b>PTC thermistor input</b>	Input through terminal AU (The function of terminal AU is switched by a switch.)	Input through terminal 2 (The function of terminal 2 is switched by the <b>Pr.561</b> setting.)
<b>USB connector</b>	B connector	Mini B connector
<b>Control circuit terminal block</b>	Removable terminal block (screw type)	Removable terminal block (spring clamp type)
<b>Terminal response level</b>	The FR-A800's I/O terminals have better response level than the FR-A700's terminals. By setting <b>Pr.289 Inverter output terminal filter</b> and Pr.699 Input terminal filter, the terminal response level can be compatible with that of FR-A700. Set to approximately 5 to 8 ms and adjust the setting according to the system.	
<b>PU</b>	FR-DU07 (4-digit LED) FR-PU07	FR-DU08 (5-digit LED) FR-LU08 (LCD operation panel) FR-PU07 (Some functions such as Parameter copy are unavailable.) The FR-DU07 is not supported.
<b>Plug-in option</b>	Dedicated plug-in options (not interchangeable)	

Item	FR-A700	FR-A800
Communication option	Connected to the connector 3	Connected to the connector 1
Installation size	For standard structure models, installation size is compatible for all capacities. (Replacement between the same capacities does not require new mounting holes.) For separated converter types, installation size is not compatible. (New mounting holes are required.)	
Converter	Built-in for all capacities	An optional converter unit (FR-CC2) is required for separated converter types.
DC reactor	The 75K or higher comes with a DC reactor (FR-HEL).	For the FR-A820-03800(75K) or higher, the FR-A840-02160(75K) or higher, and when a 75 kW or higher motor is used, select a DC reactor suitable for the applicable motor capacity. (A DC reactor is not included.) Separated converter types (converter unit FR-CC2) and IP55 compatible models have a built-in DC reactor.
Brake unit (75 kW or higher)	FR-BU2, MT-BU5	FR-BU2

### ◆ Installation precautions

- Removal procedure of the front cover is different. (Refer to [page 33](#).)
- Plug-in options of the FR-A700 series are not compatible.
- Operation panel (FR-DU07) cannot be used.

### ◆ Wiring instructions

- The spring clamp type terminal block has changed to the screw type. Use of blade terminals is recommended.

### ◆ Instructions for continuous use of the PU07 (parameter unit) manufactured in September 2015 or earlier

- For the FR-A800 series, many functions (parameters) have been added. When setting these parameters, the parameter names and setting ranges are not displayed.
- Only the parameter with the numbers up to "999" can be read and set. The parameters with the numbers after "999" cannot be read or set.
- Many protective functions have been added for the FR-A800 series. These functions are available, but all faults are displayed as "Fault". When the fault history is checked, "ERR" appears. Added faults will not appear on the parameter unit. (However, MT1 to MT3 are displayed as MT.)
- Parameter copy/verification function are not available.

### ◆ Copying parameter settings

- The FR-A700 series' parameter settings can be easily copied to the FR-A800 series by using the setup software (FR Configurator2). (Not supported by the setup software FR-SW3-SETUP or older.)

## 9.1.2 Replacement of the FR-A500(L) series

### ◆ Installation precautions

- Installation size is compatible for replacing the FR-A520(L)-0.4K to 90K, FR-A540(L)-0.4K to 7.5K, 18.5K to 55K, 110K, 160K, or 220K. New mounting holes are required for replacing models with other capacities.
- To use the same mounting holes of the FR-A540-11K or 15K for the A800 series, the optional installation interchange attachment (FR-AAT) is necessary.
- The external heat sink attachment is not interchangeable.  
The enclosure cut dimensions of the FR-A520-3.7K or lower, FR-A520-30K, FR-A520-55K or higher, FR-A540-3.7K or lower, FR-A540-11K and 15K, and FR-A540-75K or higher are not compatible.

#### NOTE

- For the installation size and the outline dimensions of the separated converter type, refer to the FR-A802 (Separated Converter Type) Instruction Manual (Hardware).

## 9.2 International standards

- For information on compliance with EU Directives or standards including UL or cUL standards, refer to both the Startup and Hardware versions of the Instruction Manual.

## 9.3 Acquisition of type certification for ship classification standards (400 V class)

### 9.3.1 Applicable models

Structure/functionality	Applicable inverter
Standard model	FR-A840-00023(0.4K) to 06830(280K)
Separated converter type	FR-A842-07700(315K) to 12120(500K) FR-CC2-H315 to H500K
IP55 compatible model	FR-A846-00023(0.4K) to 03610(132K)-C2 <sup>*1</sup>

<sup>\*1</sup> FR-A846-00023(0.4K) to 03610(132K)-C3 inverters are not applicable.

### 9.3.2 Details of type certification for standard model / Separated converter type

The inverters can be used in ships, except on the bridge and open deck areas.

#### ◆ Details of certification

Certification body	Certificate number	Compatible from (Manufacture year and month)
NK (Nippon Kaiji Kyokai)	14A020	September 2014
ABS (American Bureau of Shipping)	19-YO1938937-PDA 19-YO1938937-PDAPDP	September 2014
BV (Bureau Veritas)	37962/B0	October 2014
DNV GL (DNV GL AS) <sup>*1</sup>	TAE00000H2	November 2015
LR (Lloyd's Register of British and Foreign Shipping)	LR2002550TA-CERT LR2002550TA-DAD LR2002550TA-Appendix	November 2014
CCS (China Classification Society)	DB15T00005 DB19PTB00014	April 2015
KR (Korean Register of Shipping)	TKY21652-AC002	April 2015

<sup>\*1</sup> From November 2014 to October 2015, the certification body was DNV. (Certificate No.: E-14104)

#### ◆ Precautions

The following are precautions for the system as a whole to be compliant with ship classification standards.

- To use the FR-A840-01800(55K) or lower, set AC voltage/frequency to three-phase 380 to 480 V, 50/60 Hz.
- The applicable inverters have been approved as products for use in enclosure. Install the inverters in enclosures.
- Use the inverters in an environment without corrosive gas or the like. (Inverters with circuit board coating are available for improved environmental resistance. Consult our sales office for more details.)
- For electromagnetic compatibility (EMC), install the recommended EMC filter shown in the following page (manufactured by Soshin Electric Co., Ltd.) or an equivalent at the input side of the inverter.
- Set the built-in EMC filter in the inverter to "enabled" (ON).
- Ensure that the finalized system which includes an inverter complies with the ship classification standards.

## ◆ Noise filter wiring

Install a recommended noise filter (manufactured by Soshin Electric Co., Ltd.) at the input side of the inverter as shown in the following diagram.

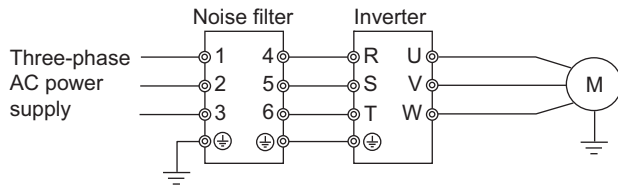

## ◆ Recommended EMC filter (manufactured by Soshin Electric Co., Ltd.)

The following section shows the specifications of recommended EMC filters to be used in combination with inverters.

### ■ Standard model

Inverter model FR-A840-□	Noise filter model			
	SLD	LD	ND	HD
00023(0.4K)	HF3010C-SZA			
00038(0.75K)				
00052(1.5K)				
00083(2.2K)	HF3020C-SZA			
00126(3.7K)				
00170(5.5K)	HF3030C-SZA	HF3020C-SZA		
00250(7.5K)	HF3030C-SZA			
00310(11K)	HF3040C-SZA			
00380(15K)	HF3050C-SZA	HF3040C-SZA		
00470(18.5K)	HF3060C-SZA			
00620(22K)	HF3080C-SZA			
00770(30K)	HF3100C-SZA			
00930(37K)	HF3150C-SZA	HF3100C-SZA		
01160(45K)	HF3150C-SZA			
01800(55K)	HF3200C-SZA			
02160(75K)	HF3250C-SZA			
02600(90K)				
03250(110K)	HF3600C-SJB	HF3300C-SJB		
03610(132K)	HF3600C-SJB	HF3300C-SJB		
04320(160K)	HF3600C-SJB			
04810(185K)				
05470(220K)				
06100(250K)				
06830(280K)	HF31000C-SJB			

### ■ Separated converter type

Inverter model FR-A842-□	Noise filter model			
	SLD	LD	ND	HD
07700(315K)	HF31000C-SJB			
08660(355K)				
09620(400K)				
10940(450K)	HF31200C-SJB			
12120(500K)	HF31600C-SJB			



## ■ Appearance examples and outline dimensions

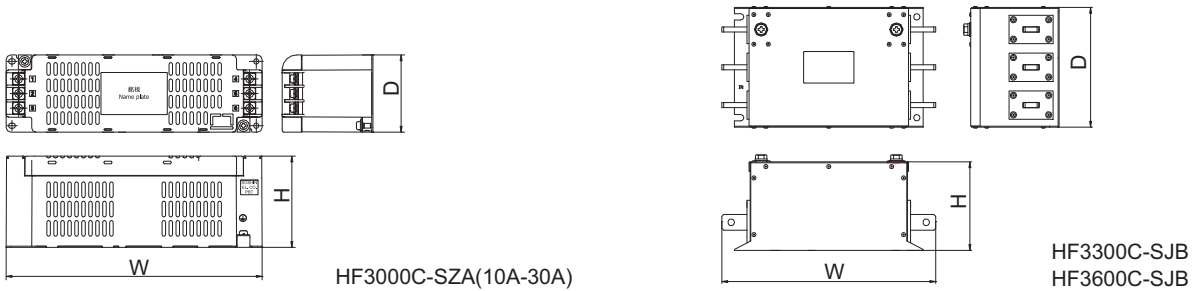

Noise filter model	W	D	H
HF3010C-SZA	220	66	78
HF3020C-SZA			
HF3030C-SZA			
HF3040C-SZA	270	80	84
HF3050C-SZA			
HF3060C-SZA			
HF3080C-SZA	310	100	210
HF3100C-SZA			
HF3150C-SZA	395	110	230
HF3200C-SZA	400	120	260
HF3250C-SZA			
HF3300C-SJB	340	190	140
HF3600C-SJB	390	190	160
HF31000C-SJB			
HF31200C-SJB			
HF31600C-SJB			
HF31600C-SJB	480	200	190

(Unit: mm)

For details on this filter, contact Soshin Electric Co., Ltd.

## 9.3.3 Details of type certification for IP55 compatible model

The inverters can be used in ships, except on the bridge and open deck areas.

### ◆ Details of certification

Certification body	Certificate number	Compatible from (Manufacture year and month)
NK (Nippon Kaiji Kyokai)	14A020	October 2015
ABS (American Bureau of Shipping)	19-YO1938937-PDA 19-YO1938937-PDAPDP	October 2015
BV (Bureau Veritas)	37962/B0	October 2015
LR (Lloyd's Register of British and Foreign Shipping)	LR2002550TA-CERT LR2002550TA-DAD LR2002550TA-Appendix	October 2015
DNV GL (DNV GL AS)	TAE00000H2	November 2015
CCS (China Classification Society)	DB16T00003 DB19PTB00014	April 2016
KR (Korean Register of Shipping)	TKY21652-AC002	April 2016

### ◆ Precautions

The following are precautions for the system as a whole to be compliant with ship classification standards.

- To use the FR-A846-01800(55K)-C2 or lower, set AC voltage/frequency to three-phase 380 to 480 V, 50/60 Hz.
- Set the built-in EMC filter in the inverter to "enabled" (ON).
- Ensure that the finalized system which includes an inverter complies with the ship classification standards.
- For electromagnetic compatibility (EMC), install the recommended ferrite core (shown in the following page) or an equivalent by two turns (passing the cable twice through the core) for wiring of control circuit terminals.

- When the inverter is used in an environment with the surrounding air temperature exceeding 40°C, the rated output current must not exceed the value shown in the following table.

Inverter model FR-A846-[-]C2	Rated output current			
	ND rating		LD rating	
	Surrounding air temperature: 45°C	Surrounding air temperature: 50°C	Surrounding air temperature: 45°C	Surrounding air temperature: 50°C
00023(0.4K)	1.4 A	1.4 A	2.0 A	1.9 A
00038(0.75K)	2.4 A	2.3 A	3.3 A	3.2 A
00052(1.5K)	3.8 A	3.6 A	4.6 A	4.3 A
00083(2.2K)	5.7 A	5.4 A	7.2 A	6.8 A
00126(3.7K)	8.6 A	8.1 A	10.9 A	9.2 A
00170(5.5K)	11.4 A	9.6 A	13.6 A	11.2 A
00250(7.5K)	16 A	15 A	22 A	21 A
00310(11K)	22 A	21 A	28 A	26 A
00380(15K)	29 A	28 A	33 A	28 A
00470(18.5K)	36 A	30 A	37 A	30.1 A
00620(22K)	42 A	40 A	54 A	51 A
00770(30K)	54 A	51 A	67 A	63 A
00930(37K)	67 A	64 A	81 A	77 A
01160(45K)	82 A	77 A	101 A	95 A
01800(55K)	105 A	99 A	137 A	130 A
02160(75K)	137 A	130 A	171 A	162 A
02600(90K)	171 A	162 A	205 A	178 A
03250(110K)	205 A	194 A	247 A	234 A
03610(132K)	247 A	234 A	284 A	244 A

### ◆ Example of installing ferrite cores

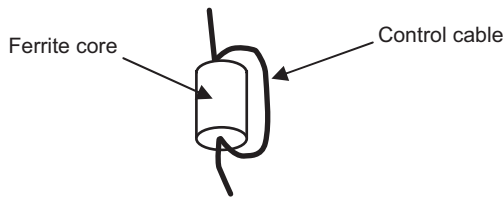

For using one ferrite core



For using two ferrite cores

- The wiring must be contained in the casing.
- When there is more than one bundle of control signal lines, install ferrite cores to each bundle.

### ◆ Recommended ferrite core

Manufacturer: TOKIN Corporation

Model: ESD-SR-250

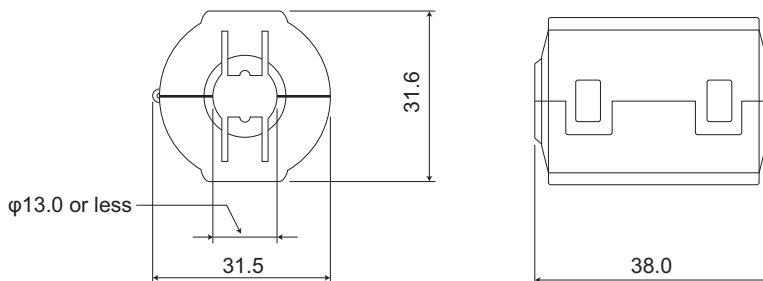

(Unit: mm)

For details on this ferrite core, contact TOKIN Corporation.

## 9.3.4 Wiring for compliance with EMC standards

- When a power supply is provided for the control circuit separately from the main circuit and a capacitive device (such as an EMC filter or a radio noise filter) is connected, connect a noise filter (example: RTMN5006 manufactured by TDK-Lambda Corporation) to the control circuit power supply.

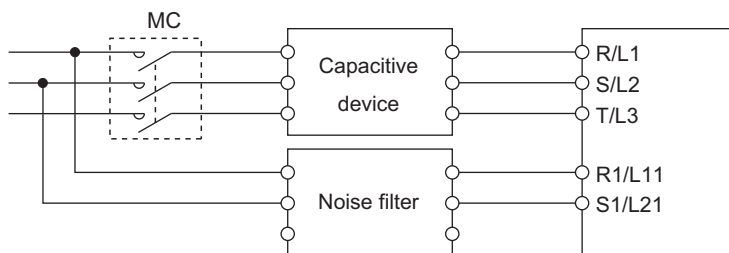

Connect two of the three phases.

- Connect the inverter, noise filter, and motor to the enclosure earth (ground). (It is assumed that the enclosure earth (ground) is connected to the ship hull earth (ground).)
- When the wiring is different from the recommended one, the noise suppression effect may be insufficient (inadequate earthing (grounding)).

## 9.4 Specification comparison between PM sensorless vector control and induction motor control

Item	PM sensorless vector control (MM-CF)		Induction motor control
<b>Applicable motor</b>	IPM motor MM-CF series (0.5 to 7.0 kW) (Refer to <a href="#">page 833.</a> ) IPM motors other than MM-CF (tuning required) <sup>*1</sup>		Induction motor <sup>*1</sup>
<b>Starting torque</b>	High frequency superposition control	200% (when used with MM-CF, 200% for the 1.5 kW or lower, and 150% for the 2.0 kW or higher)	200% (FR-A820-00250(3.7K) or lower and FR-A840-00126(3.7K) or lower). 150% (FR-A820-00340(5.5K) or higher and FR-A840-00126(3.7K) or higher) under Real sensorless vector control and Vector control.
	Current synchronization operation	50%	
<b>Zero speed</b>	High frequency superposition control	Available (Select the HD rating for zero speed 200%.)	Available under Real sensorless vector control and Vector control
	Current synchronization operation	Not available	
<b>Carrier frequency</b>	High frequency superposition control	6 kHz ( <b>Pr.72</b> = "0 to 9"), 10 kHz ( <b>Pr.72</b> = "10 to 13"), 14 kHz ( <b>Pr.72</b> = "14 or 15") (6 kHz in a low-speed range of 10 kHz or higher. 2 kHz is not selectable.)	Any value in the range of 0.75 kHz to 14.5 kHz (FR-A820-03160(55K) or lower and FR-A840-01800(55K) or lower)  0.75 kHz to 6 kHz (FR-A820-03800(75K) or higher, FR-A840-02160(75K) or higher)
	Current synchronization operation	2 kHz ( <b>Pr.72</b> = "0 to 5"), 6 kHz ( <b>Pr.72</b> = "6 to 9"), 10 kHz ( <b>Pr.72</b> = "10 to 13"), 14 kHz ( <b>Pr.72</b> = "14 or 15") (6 kHz in a low-speed range of 10 kHz or higher.)	
<b>Automatic restart after instantaneous power failure</b>	No startup delay time. Using the regeneration avoidance function or retry function together is recommended.		Startup waiting time exists.
<b>Startup delay</b>	Startup delay of about 0.1 second for magnetic pole position detection.		No startup delay (when online auto tuning is not performed at startup).
<b>Driving by the commercial power supply</b>	Cannot be driven by the commercial power supply.		Can be driven by the commercial power supply. (Other than vector control dedicated motor.)
<b>Operation during coasting</b>	While the motor is coasting, potential is generated across motor terminals.		While the motor is coasting, potential is not generated across motor terminals.
<b>Torque control</b>	Not available		Available under Real sensorless vector control and Vector control
<b>Position control</b>	High frequency superposition control	Available (sensorless)	Available under Vector control.
	Current synchronization operation	Not available	

\*1 For the motor capacity, the rated motor current should be equal to or less than the rated inverter current. (It must be 0.4 kW or higher.)  
If a motor with substantially low rated current compared with the inverter rated current is used, speed and torque accuracies may deteriorate due to torque ripples, etc. Set the rated motor current to about 40% or higher of the inverter rated current.

### NOTE

- Before wiring, make sure that the motor is stopped. Otherwise you may get an electric shock.
- Never connect an IPM motor to the commercial power supply.
- No slippage occurs with an IPM motor because of its characteristic. If an IPM motor, which took over an induction motor, is driven at the same speed as for the general-purpose motor, the running speed of the IPM motor becomes faster by the amount of the general-purpose motor's slippage. Adjust the speed command to run the IPM motor at the same speed as the induction motor, as required.

# 9.5 Parameters (functions) and instruction codes under different control methods

- \*1 Instruction codes are used to read and write parameters in accordance with the Mitsubishi inverter protocol of RS-485 communication. (For RS-485 communication, refer to [page 670](#).)
- \*2 Function availability under each control method is shown as follows:
  - : Available
  - ×: Not available
  - Δ: Available with some restrictions
- \*3 If function availability differs between using induction motors with an encoder and using PM motors with an encoder, the function availability using PM motors with an encoder is described in parentheses. Also, a PM motor with an encoder is not available in the torque control mode.
- \*4 For Parameter copy, Parameter clear, and All parameter clear, ○ indicates the function is available, and × indicates the function is not available.
- \*5 Communication parameters that are not cleared by parameter clear or all clear (H5A5A or H55AA) via communication. (For RS-485 communication, refer to [page 670](#).)
- \*6 When a communication option is installed, parameter clear (lock release) during password lock (**Pr.297 Password lock/unlock** ≠ "9999") can be performed only from the communication option.
- \*7 Available when the IPM motor MM-CF series is used and the low-speed range high-torque characteristic is enabled (**Pr.788 Low speed range torque characteristic selection** = "9999 (initial value)").
- \*8 Reading and writing via the PU connector are available.

Symbols in the table indicate parameters that operate when the options are connected.

[AP]FR-A8AP, [AL]FR-A8AL, [TP]FR-A8TP, [APR]FR-A8APR, [APS]FR-A8APS, [APA]FR-A8APA, [AR]FR-A8AR, [AX]FR-A8AX, [AY]FR-A8AY, [AZ]FR-A8AZ, [AVP]FR-A8AVP, [NC]FR-A8NC, [NCE]FR-A8NCE, [NCG]FR-A8NCG, [ND]FR-A8ND, [NP]FR-A8NP, [NF]FR-A8NF, [NS]FR-A8NS

Pr.	Name	Instruction code <sup>*1</sup>			Control method <sup>*2</sup>									Parameter		
		Read	Write	Extended	V/F	Magnetic flux	Vector <sup>*3</sup>			Sensorless		PM		Copy <sup>*4</sup>	Clear <sup>*4</sup>	All clear <sup>*4</sup>
							Speed control	Torque control	Position control	Speed control	Torque control	Speed control	Position control <sup>*7</sup>			
0	Torque boost	00	80	0	○	×	×	×	×	×	×	×	×	○	○	○
1	Maximum frequency	01	81	0	○	○	○	○	○	○	○	○	○	○	○	○
2	Minimum frequency	02	82	0	○	○	○	○	×	○	○	○	×	○	○	○
3	Base frequency	03	83	0	○	×	×	×	×	×	×	×	×	○	○	○
4	Multi-speed setting (high speed)	04	84	0	○	○	○	○	Δ	○	○	○	Δ	○	○	○
5	Multi-speed setting (middle speed)	05	85	0	○	○	○	○	Δ	○	○	○	Δ	○	○	○
6	Multi-speed setting (low speed)	06	86	0	○	○	○	○	Δ	○	○	○	Δ	○	○	○
7	Acceleration time	07	87	0	○	○	○	○	Δ	○	○	○	Δ	○	○	○
8	Deceleration time	08	88	0	○	○	○	○	Δ	○	○	○	Δ	○	○	○
9	Electronic thermal O/L relay	09	89	0	○	○	○	○	○	○	○	○	○	○	○	○
10	DC injection brake operation frequency	0A	8A	0	○	○	○	○	×	○	○	○	×	○	○	○
11	DC injection brake operation time	0B	8B	0	○	○	○	○	×	○	○	○	×	○	○	○
12	DC injection brake operation voltage	0C	8C	0	○	○	×	×	×	×	×	×	×	○	○	○
13	Starting frequency	0D	8D	0	○	○	○	○	×	○	○	○	×	○	○	○
14	Load pattern selection	0E	8E	0	○	×	×	×	×	×	×	×	×	○	○	○
15	Jog frequency	0F	8F	0	○	○	○	○	×	○	○	○	×	○	○	○
16	Jog acceleration/deceleration time	10	90	0	○	○	○	○	×	○	○	○	×	○	○	○
17	MRS input selection	11	91	0	○	○	○	○	○	○	○	○	○	○	○	○
18	High speed maximum frequency	12	92	0	○	○	○	○	○	○	○	○	○	○	○	○
19	Base frequency voltage	13	93	0	○	×	×	×	×	×	×	×	×	○	○	○
20	Acceleration/deceleration reference frequency	14	94	0	○	○	○	○	Δ	○	○	○	Δ	○	○	○

Pr.	Name	Instruction code <sup>*1</sup>					Control method <sup>*2</sup>								Parameter		
		Read	Write	Extended	V/F	Magnetic flux	Vector <sup>*3</sup>			Sensorless		PM			Copy <sup>*4</sup>	Clear <sup>*4</sup>	All clear <sup>*4</sup>
							Speed control	Torque control	Position control	Speed control	Torque control	Speed control <sup>*7</sup>	Position control <sup>*7</sup>				
21	Acceleration/deceleration time increments	15	95	0	○	○	○	○	△	○	○	○	△	○	○	○	
22	Stall prevention operation level (Torque limit level)	16	96	0	○	○	○	○	○	○	○	○	○	○	○	○	
23	Stall prevention operation level compensation factor at double speed	17	97	0	○	○	×	×	×	×	×	×	×	○	○	○	
24	Multi-speed setting (speed 4)	18	98	0	○	○	○	○	△	○	○	○	△	○	○	○	
25	Multi-speed setting (speed 5)	19	99	0	○	○	○	○	△	○	○	○	△	○	○	○	
26	Multi-speed setting (speed 6)	1A	9A	0	○	○	○	○	△	○	○	○	△	○	○	○	
27	Multi-speed setting (speed 7)	1B	9B	0	○	○	○	○	△	○	○	○	△	○	○	○	
28	Multi-speed input compensation selection	1C	9C	0	○	○	○	○	×	○	○	○	×	○	○	○	
29	Acceleration/deceleration pattern selection	1D	9D	0	○	○	○	○	×	○	○	○	×	○	○	○	
30	Regenerative function selection	1E	9E	0	○	○	○	○	○	○	○	○	○	○	○	○	
31	Frequency jump 1A	1F	9F	0	○	○	○	○	×	○	○	○	×	○	○	○	
32	Frequency jump 1B	20	A0	0	○	○	○	○	×	○	○	○	×	○	○	○	
33	Frequency jump 2A	21	A1	0	○	○	○	○	×	○	○	○	×	○	○	○	
34	Frequency jump 2B	22	A2	0	○	○	○	○	×	○	○	○	×	○	○	○	
35	Frequency jump 3A	23	A3	0	○	○	○	○	×	○	○	○	×	○	○	○	
36	Frequency jump 3B	24	A4	0	○	○	○	○	×	○	○	○	×	○	○	○	
37	Speed display	25	A5	0	○	○	○	○	○	○	○	○	○	○	○	○	
41	Up-to-frequency sensitivity	29	A9	0	○	○	○	×	×	○	×	○	×	○	○	○	
42	Output frequency detection	2A	AA	0	○	○	○	△	△	○	△	○	△	○	○	○	
43	Output frequency detection for reverse rotation	2B	AB	0	○	○	○	△	△	○	△	○	△	○	○	○	
44	Second acceleration/deceleration time	2C	AC	0	○	○	○	○	△	○	○	○	△	○	○	○	
45	Second deceleration time	2D	AD	0	○	○	○	○	△	○	○	○	△	○	○	○	
46	Second torque boost	2E	AE	0	○	×	×	×	×	×	×	×	×	○	○	○	
47	Second V/F (base frequency)	2F	AF	0	○	×	×	×	×	×	×	×	×	○	○	○	
48	Second stall prevention operation level	30	B0	0	○	○	×	×	×	×	×	×	×	○	○	○	
49	Second stall prevention operation frequency	31	B1	0	○	○	×	×	×	×	×	×	×	○	○	○	
50	Second output frequency detection	32	B2	0	○	○	○	△	△	○	△	○	△	○	○	○	
51	Second electronic thermal O/L relay	33	B3	0	○	○	○	○	○	○	○	○	○	○	○	○	
52	Operation panel main monitor selection	34	B4	0	○	○	○	○	○	○	○	○	○	○	○	○	
54	FM/CA terminal function selection	36	B6	0	○	○	○	○	○	○	○	○	○	○	○	○	
55	Frequency monitoring reference	37	B7	0	○	○	○	○	○	○	○	○	○	○	○	○	
56	Current monitoring reference	38	B8	0	○	○	○	○	○	○	○	○	○	○	○	○	
57	Restart coasting time	39	B9	0	○	○	○	○	×	○	○	○	×	○	○	○	
58	Restart cushion time	3A	BA	0	○	○	×	×	×	×	×	×	×	○	○	○	
59	Remote function selection	3B	BB	0	○	○	○	○	×	○	○	○	×	○	○	○	
60	Energy saving control selection	3C	BC	0	○	○	×	×	×	×	×	×	×	○	○	○	
61	Reference current	3D	BD	0	○	○	○ (x)	×	×	○	×	×	×	○	○	○	
62	Reference value at acceleration	3E	BE	0	○	○	○ (x)	×	×	○	×	×	×	○	○	○	

Pr.	Name	Instruction code <sup>*1</sup>					Control method <sup>*2</sup>							Parameter		
		Read	Write	Extended	V/F	Magnetic flux	Vector <sup>*3</sup>			Sensorless		PM		Copy <sup>*4</sup>	Clear <sup>*4</sup>	All clear <sup>*4</sup>
							Speed control	Torque control	Position control	Speed control	Torque control	Speed control	Position control <sup>*7</sup>			
63	Reference value at deceleration	3F	BF	0	○	○	○ (x)	x	x	○	x	x	x	○	○	○
64	Starting frequency for elevator mode	40	C0	0	○	x	x	x	x	x	x	x	x	○	○	○
65	Retry selection	41	C1	0	○	○	○	○	x	○	○	○	x	○	○	○
66	Stall prevention operation reduction starting frequency	42	C2	0	○	○	x	x	x	x	x	x	x	○	○	○
67	Number of retries at fault occurrence	43	C3	0	○	○	○	○	x	○	○	○	x	○	○	○
68	Retry waiting time	44	C4	0	○	○	○	○	x	○	○	○	x	○	○	○
69	Retry count display erase	45	C5	0	○	○	○	○	x	○	○	○	x	○	○	○
70	Special regenerative brake duty	46	C6	0	○	○	○	○	○	○	○	○	○	○	○	○
71	Applied motor	47	C7	0	○	○	○	○	○	○	○	○	○	○	○	○
72	PWM frequency selection	48	C8	0	○	○	○	○	○	○	○	○	○	○	○	○
73	Analog input selection	49	C9	0	○	○	○	○	x	○	○	○	x	○	x	○
74	Input filter time constant	4A	CA	0	○	○	○	○	x	○	○	○	x	○	○	○
75	Reset selection/disconnected PU detection/PU stop selection	4B	CB	0	○	○	○	○	○	○	○	○	○	○	x	x
76	Fault code output selection	4C	CC	0	○	○	○	○	○	○	○	○	○	○	○	○
77 <sup>*8</sup>	Parameter write selection	4D	CD	0	○	○	○	○	○	○	○	○	○	○	○	○
78	Reverse rotation prevention selection	4E	CE	0	○	○	○	○	○	○	○	○	○	○	○	○
79 <sup>*8</sup>	Operation mode selection	4F	CF	0	○	○	○	○	○	○	○	○	○	○	○	○
80	Motor capacity	50	D0	0	x	○	○	○	○	○	○	○	○	○	○	○
81	Number of motor poles	51	D1	0	x	○	○	○	○	○	○	○	○	○	○	○
82	Motor excitation current	52	D2	0	x	○	○ (x)	○	○ (x)	○	○	x	x	○	x	○
83	Rated motor voltage	53	D3	0	x	○	○	○	○ (x)	○	○	○	x	○	○	○
84	Rated motor frequency	54	D4	0	x	○	○	○	○	○	○	○	○	○	○	○
85	Excitation current break point	55	D5	0	x	○	x	x	x	○	○	x	x	○	x	○
86	Excitation current low-speed scaling factor	56	D6	0	x	○	x	x	x	○	○	x	x	○	x	○
89	Speed control gain (Advanced magnetic flux vector)	59	D9	0	x	○	x	x	x	x	x	x	x	○	x	○
90	Motor constant (R1)	5A	DA	0	x	○	○	○	○	○	○	○	○	○	x	○
91	Motor constant (R2)	5B	DB	0	x	○	○ (x)	○	○ (x)	○	○	x	x	○	x	○
92	Motor constant (L1)/d-axis inductance (Ld)	5C	DC	0	x	○	○	○	○	○	○	○	○	○	x	○
93	Motor constant (L2)/q-axis inductance (Lq)	5D	DD	0	x	○	○	○	○	○	○	○	○	○	x	○
94	Motor constant (X)	5E	DE	0	x	○	○ (x)	○	○ (x)	○	○	x	x	○	x	○
95	Online auto tuning selection	5F	DF	0	x	○	○ (x)	○	○ (x)	○	○	x	x	○	○	○
96	Auto tuning setting/status	60	E0	0	x	○	○	○	○ (x)	○	○	○	x	○	x	○
100	V/F1 (first frequency)	00	80	1	○	x	x	x	x	x	x	x	x	○	○	○
101	V/F1 (first frequency voltage)	01	81	1	○	x	x	x	x	x	x	x	x	○	○	○
102	V/F2 (second frequency)	02	82	1	○	x	x	x	x	x	x	x	x	○	○	○
103	V/F2 (second frequency voltage)	03	83	1	○	x	x	x	x	x	x	x	x	○	○	○
104	V/F3 (third frequency)	04	84	1	○	x	x	x	x	x	x	x	x	○	○	○
105	V/F3 (third frequency voltage)	05	85	1	○	x	x	x	x	x	x	x	x	○	○	○

Pr.	Name	Instruction code <sup>*1</sup>			Control method <sup>*2</sup>										Parameter		
		Read	Write	Extended	V/F	Magnetic flux	Vector <sup>*3</sup>			Sensorless		PM		Copy <sup>*4</sup>	Clear <sup>*4</sup>	All clear <sup>*4</sup>	
							Speed control	Torque control	Position control	Speed control	Torque control	Speed control <sup>*7</sup>	Position control <sup>*7</sup>				
106	V/F4 (fourth frequency)	06	86	1	○	×	×	×	×	×	×	×	×	○	○	○	
107	V/F4 (fourth frequency voltage)	07	87	1	○	×	×	×	×	×	×	×	×	○	○	○	
108	V/F5 (fifth frequency)	08	88	1	○	×	×	×	×	×	×	×	×	○	○	○	
109	V/F5 (fifth frequency voltage)	09	89	1	○	×	×	×	×	×	×	×	×	○	○	○	
110	Third acceleration/deceleration time	0A	8A	1	○	○	○	○	△	○	○	○	△	○	○	○	
111	Third deceleration time	0B	8B	1	○	○	○	○	△	○	○	○	△	○	○	○	
112	Third torque boost	0C	8C	1	○	×	×	×	×	×	×	×	×	○	○	○	
113	Third V/F (base frequency)	0D	8D	1	○	×	×	△	△	×	△	×	△	○	○	○	
114	Third stall prevention operation level	0E	8E	1	○	○	×	×	×	×	×	×	×	○	○	○	
115	Third stall prevention operation frequency	0F	8F	1	○	○	×	×	×	×	×	×	×	○	○	○	
116	Third output frequency detection	10	90	1	○	○	○	△	△	○	△	○	△	○	○	○	
117	PU communication station number	11	91	1	○	○	○	○	○	○	○	○	○	○	○ <sup>*5</sup>	○ <sup>*5</sup>	
118	PU communication speed	12	92	1	○	○	○	○	○	○	○	○	○	○	○ <sup>*5</sup>	○ <sup>*5</sup>	
119	PU communication stop bit length / data length	13	93	1	○	○	○	○	○	○	○	○	○	○	○ <sup>*5</sup>	○ <sup>*5</sup>	
120	PU communication parity check	14	94	1	○	○	○	○	○	○	○	○	○	○	○ <sup>*5</sup>	○ <sup>*5</sup>	
121	PU communication retry count	15	95	1	○	○	○	○	○	○	○	○	○	○	○ <sup>*5</sup>	○ <sup>*5</sup>	
122	PU communication check time interval	16	96	1	○	○	○	○	○	○	○	○	○	○	○ <sup>*5</sup>	○ <sup>*5</sup>	
123	PU communication waiting time setting	17	97	1	○	○	○	○	○	○	○	○	○	○	○ <sup>*5</sup>	○ <sup>*5</sup>	
124	PU communication CR/LF selection	18	98	1	○	○	○	○	○	○	○	○	○	○	○ <sup>*5</sup>	○ <sup>*5</sup>	
125	Terminal 2 frequency setting gain frequency	19	99	1	○	○	○	○	×	○	○	○	×	○	×	○	
126	Terminal 4 frequency setting gain frequency	1A	9A	1	○	○	○	○	×	○	○	○	×	○	×	○	
127	PID control automatic switchover frequency	1B	9B	1	○	○	○	×	×	○	×	○	×	○	○	○	
128	PID action selection	1C	9C	1	○	○	○	×	×	○	×	○	×	○	○	○	
129	PID proportional band	1D	9D	1	○	○	○	×	×	○	×	○	×	○	○	○	
130	PID integral time	1E	9E	1	○	○	○	×	×	○	×	○	×	○	○	○	
131	PID upper limit	1F	9F	1	○	○	○	×	×	○	×	○	×	○	○	○	
132	PID lower limit	20	A0	1	○	○	○	×	×	○	×	○	×	○	○	○	
133	PID action set point	21	A1	1	○	○	○	×	×	○	×	○	×	○	○	○	
134	PID differential time	22	A2	1	○	○	○	×	×	○	×	○	×	○	○	○	
135	Electronic bypass sequence selection	23	A3	1	○	○	○ (x)	×	×	○	×	×	×	○	○	○	
136	MC switchover interlock time	24	A4	1	○	○	○ (x)	×	×	○	×	×	×	○	○	○	
137	Start waiting time	25	A5	1	○	○	○ (x)	×	×	○	×	×	×	○	○	○	
138	Bypass selection at a fault	26	A6	1	○	○	○ (x)	×	×	○	×	×	×	○	○	○	
139	Automatic switchover frequency from inverter to bypass operation	27	A7	1	○	○	○ (x)	×	×	○	×	×	×	○	○	○	
140	Backlash acceleration stopping frequency	28	A8	1	○	○	○	○	×	○	○	○	×	○	○	○	
141	Backlash acceleration stopping time	29	A9	1	○	○	○	○	×	○	○	○	×	○	○	○	



Pr.	Name	Instruction code <sup>*1</sup>			Control method <sup>*2</sup>									Parameter		
		Read	Write	Extended	V/F	Magnetic flux	Vector <sup>*3</sup>			Sensorless		PM		Copy <sup>*4</sup>	Clear <sup>*4</sup>	All clear <sup>*4</sup>
							Speed control	Torque control	Position control	Speed control	Torque control	Speed control	Position control <sup>*7</sup>			
142	Backlash deceleration stopping frequency	2A	AA	1	○	○	○	○	×	○	○	○	×	○	○	○
143	Backlash deceleration stopping time	2B	AB	1	○	○	○	○	×	○	○	○	×	○	○	○
144	Speed setting switchover	2C	AC	1	○	○	○	○	○	○	○	○	○	○	○	○
145	PU display language selection	2D	AD	1	○	○	○	○	○	○	○	○	○	○	×	×
147	Acceleration/deceleration time switching frequency	2F	AF	1	○	○	○	○	Δ	○	○	○	Δ	○	○	○
148	Stall prevention level at 0 V input	30	B0	1	○	○	×	×	×	×	×	×	×	○	○	○
149	Stall prevention level at 10 V input	31	B1	1	○	○	×	×	×	×	×	×	×	○	○	○
150	Output current detection level	32	B2	1	○	○	○	○	○	○	○	○	○	○	○	○
151	Output current detection signal delay time	33	B3	1	○	○	○	○	○	○	○	○	○	○	○	○
152	Zero current detection level	34	B4	1	○	○	○	○	○	○	○	○	○	○	○	○
153	Zero current detection time	35	B5	1	○	○	○	○	○	○	○	○	○	○	○	○
154	Voltage reduction selection during stall prevention operation	36	B6	1	○	○	×	×	×	×	×	×	×	○	○	○
155	RT signal function validity condition selection	37	B7	1	○	○	○	×	×	○	×	○	×	○	○	○
156	Stall prevention operation selection	38	B8	1	○	○	○	×	×	○	×	○	×	○	○	○
157	OL signal output timer	39	B9	1	○	○	○	○	○	○	○	○	○	○	○	○
158	AM terminal function selection	3A	BA	1	○	○	○	○	○	○	○	○	○	○	○	○
159	Automatic switchover frequency range from bypass to inverter operation	3B	BB	1	○	○	○ (x)	×	×	○	×	×	×	○	○	○
160	User group read selection	00	80	2	○	○	○	○	○	○	○	○	○	○	○	○
161	Frequency setting/key lock operation selection	01	81	2	○	○	○	○	○	○	○	○	○	○	×	○
162	Automatic restart after instantaneous power failure selection	02	82	2	○	○	○	○	×	○	○	○	×	○	○	○
163	First cushion time for restart	03	83	2	○	○	×	×	×	×	×	×	×	○	○	○
164	First cushion voltage for restart	04	84	2	○	○	×	×	×	×	×	×	×	○	○	○
165	Stall prevention operation level for restart	05	85	2	○	○	×	×	×	×	×	×	×	○	○	○
166	Output current detection signal retention time	06	86	2	○	○	○	○	○	○	○	○	○	○	○	○
167	Output current detection operation selection	07	87	2	○	○	○	○	○	○	○	○	○	○	○	○
168	Parameter for manufacturer setting. Do not set.															
169																
170	Watt-hour meter clear	0A	8A	2	○	○	○	○	○	○	○	○	○	○	×	○
171	Operation hour meter clear	0B	8B	2	○	○	○	○	○	○	○	○	○	×	×	×
172	User group registered display/batch clear	0C	8C	2	○	○	○	○	○	○	○	○	○	×	×	×
173	User group registration	0D	8D	2	○	○	○	○	○	○	○	○	○	×	×	×
174	User group clear	0E	8E	2	○	○	○	○	○	○	○	○	○	×	×	×
178	STF terminal function selection	12	92	2	○	○	○	○	○	○	○	○	○	○	×	○
179	STR terminal function selection	13	93	2	○	○	○	○	○	○	○	○	○	○	×	○
180	RL terminal function selection	14	94	2	○	○	○	○	○	○	○	○	○	○	×	○
181	RM terminal function selection	15	95	2	○	○	○	○	○	○	○	○	○	○	×	○
182	RH terminal function selection	16	96	2	○	○	○	○	○	○	○	○	○	○	×	○

Pr.	Name	Instruction code <sup>*1</sup>			Control method <sup>*2</sup>									Parameter			
		Read	Write	Extended	V/F	Magnetic flux	Vector <sup>*3</sup>			Sensorless		PM		Copy <sup>*4</sup>	Clear <sup>*4</sup>	All clear <sup>*4</sup>	
							Speed control	Torque control	Position control	Speed control	Torque control	Speed control <sup>*7</sup>	Position control <sup>*7</sup>				
183	RT terminal function selection	17	97	2	○	○	○	○	○	○	○	○	○	○	○	○	○
184	AU terminal function selection	18	98	2	○	○	○	○	○	○	○	○	○	○	○	○	○
185	JOG terminal function selection	19	99	2	○	○	○	○	○	○	○	○	○	○	○	○	○
186	CS terminal function selection	1A	9A	2	○	○	○	○	○	○	○	○	○	○	○	○	○
187	MRS terminal function selection	1B	9B	2	○	○	○	○	○	○	○	○	○	○	○	○	○
188	STOP terminal function selection	1C	9C	2	○	○	○	○	○	○	○	○	○	○	○	○	○
189	RES terminal function selection	1D	9D	2	○	○	○	○	○	○	○	○	○	○	○	○	○
190	RUN terminal function selection	1E	9E	2	○	○	○	○	○	○	○	○	○	○	○	○	○
191	SU terminal function selection	1F	9F	2	○	○	○	○	○	○	○	○	○	○	○	○	○
192	IPF terminal function selection	20	A0	2	○	○	○	○	○	○	○	○	○	○	○	○	○
193	OL terminal function selection	21	A1	2	○	○	○	○	○	○	○	○	○	○	○	○	○
194	FU terminal function selection	22	A2	2	○	○	○	○	○	○	○	○	○	○	○	○	○
195	ABC1 terminal function selection	23	A3	2	○	○	○	○	○	○	○	○	○	○	○	○	○
196	ABC2 terminal function selection	24	A4	2	○	○	○	○	○	○	○	○	○	○	○	○	○
232	Multi-speed setting (speed 8)	28	A8	2	○	○	○	○	Δ	○	○	○	Δ	○	○	○	○
233	Multi-speed setting (speed 9)	29	A9	2	○	○	○	○	Δ	○	○	○	Δ	○	○	○	○
234	Multi-speed setting (speed 10)	2A	AA	2	○	○	○	○	Δ	○	○	○	Δ	○	○	○	○
235	Multi-speed setting (speed 11)	2B	AB	2	○	○	○	○	Δ	○	○	○	Δ	○	○	○	○
236	Multi-speed setting (speed 12)	2C	AC	2	○	○	○	○	Δ	○	○	○	Δ	○	○	○	○
237	Multi-speed setting (speed 13)	2D	AD	2	○	○	○	○	Δ	○	○	○	Δ	○	○	○	○
238	Multi-speed setting (speed 14)	2E	AE	2	○	○	○	○	Δ	○	○	○	Δ	○	○	○	○
239	Multi-speed setting (speed 15)	2F	AF	2	○	○	○	○	Δ	○	○	○	Δ	○	○	○	○
240	Soft-PWM operation selection	30	B0	2	○	○	○	○	○	○	○	○	○	○	○	○	○
241	Analog input display unit switchover	31	B1	2	○	○	○	○	○	○	○	○	○	○	○	○	○
242	Terminal 1 added compensation amount (terminal 2)	32	B2	2	○	○	○	○	×	○	○	○	×	○	○	○	○
243	Terminal 1 added compensation amount (terminal 4)	33	B3	2	○	○	○	○	×	○	○	○	×	○	○	○	○
244	Cooling fan operation selection	34	B4	2	○	○	○	○	○	○	○	○	○	○	○	○	○
245	Rated slip	35	B5	2	○	×	×	×	×	×	×	×	×	○	○	○	○
246	Slip compensation time constant	36	B6	2	○	×	×	×	×	×	×	×	×	○	○	○	○
247	Constant output range slip compensation selection	37	B7	2	○	×	×	×	×	×	×	×	×	○	○	○	○
248	Self power management selection	38	B8	2	○	○	×	×	×	×	×	○	×	○	○	○	○
249	Earth (ground) fault detection at start	39	B9	2	○	○	×	×	×	×	×	×	×	○	○	○	○
250	Stop selection	3A	BA	2	○	○	○	○	×	○	○	○	×	○	○	○	○
251	Output phase loss protection selection	3B	BB	2	○	○	○	○	○	○	○	○	○	○	○	○	○
252	Override bias	3C	BC	2	○	○	○	○	×	○	○	○	×	○	○	○	○
253	Override gain	3D	BD	2	○	○	○	○	×	○	○	○	×	○	○	○	○
254	Main circuit power OFF waiting time	3E	BE	2	○	○	×	×	×	×	×	○	×	○	○	○	○
255	Life alarm status display	3F	BF	2	○	○	○	○	○	○	○	○	○	×	×	×	×
256	Inrush current limit circuit life display	40	C0	2	○	○	○	○	○	○	○	○	○	×	×	×	×
257	Control circuit capacitor life display	41	C1	2	○	○	○	○	○	○	○	○	○	×	×	×	×
258	Main circuit capacitor life display	42	C2	2	○	○	○	○	○	○	○	○	○	×	×	×	×
259	Main circuit capacitor life measuring	43	C3	2	○	○	○	○	○	○	○	○	○	○	○	○	○

Pr.	Name	Instruction code <sup>*1</sup>			Control method <sup>*2</sup>									Parameter		
		Read	Write	Extended	V/F	Magnetic flux	Vector <sup>*3</sup>			Sensorless		PM		Copy <sup>*4</sup>	Clear <sup>*4</sup>	All clear <sup>*4</sup>
							Speed control	Torque control	Position control	Speed control	Torque control	Speed control	Position control <sup>*7</sup>			
260	PWM frequency automatic switchover	44	C4	2	○	○	○	○	○	○	○	○	○	○	○	○
261	Power failure stop selection	45	C5	2	○	○	○	○	×	○	○	○	×	○	○	○
262	Subtracted frequency at deceleration start	46	C6	2	○	○	○	○	×	○	○	○	×	○	○	○
263	Subtraction starting frequency	47	C7	2	○	○	○	○	×	○	○	○	×	○	○	○
264	Power-failure deceleration time 1	48	C8	2	○	○	○	○	×	○	○	○	×	○	○	○
265	Power-failure deceleration time 2	49	C9	2	○	○	○	○	×	○	○	○	×	○	○	○
266	Power failure deceleration time switchover frequency	4A	CA	2	○	○	○	○	×	○	○	○	×	○	○	○
267	Terminal 4 input selection	4B	CB	2	○	○	○	○	○	○	○	○	○	○	×	○
268	Monitor decimal digits selection	4C	CC	2	○	○	○	○	○	○	○	○	○	○	○	○
269	Parameter for manufacturer setting. Do not set.															
270	Stop-on contact/load torque high-speed frequency control selection	4E	CE	2	○	○	○	×	×	○	×	×	×	○	○	○
271	High-speed setting maximum current	4F	CF	2	○	○	○	×	×	○	×	×	×	○	○	○
272	Middle-speed setting minimum current	50	D0	2	○	○	○	×	×	○	×	×	×	○	○	○
273	Current averaging range	51	D1	2	○	○	○	×	×	○	×	×	×	○	○	○
274	Current averaging filter time constant	52	D2	2	○	○	○	×	×	○	×	×	×	○	○	○
275	Stop-on contact excitation current low-speed scaling factor	53	D3	2	×	○	×	×	×	○	×	×	×	○	○	○
276	PWM carrier frequency at stop-on contact	54	D4	2	×	○	×	×	×	○	×	×	×	○	○	○
278	Brake opening frequency	56	D6	2	○	○	○	×	×	○	×	○	×	○	○	○
279	Brake opening current	57	D7	2	○	○	○	×	×	○	×	○	×	○	○	○
280	Brake opening current detection time	58	D8	2	○	○	○	×	×	○	×	○	×	○	○	○
281	Brake operation time at start	59	D9	2	○	○	○	×	×	○	×	○	×	○	○	○
282	Brake operation frequency	5A	DA	2	○	○	○	×	×	○	×	○	×	○	○	○
283	Brake operation time at stop	5B	DB	2	○	Δ	○	×	×	×	×	○	×	○	○	○
284	Deceleration detection function selection	5C	DC	2	×	Δ	○	×	×	○	×	○	×	○	○	○
285	Overspeed detection frequency (Speed deviation excess detection frequency)	5D	DD	2	×	Δ	○	×	×	×	×	×	×	○	○	○
286	Droop gain	5E	DE	2	×	○	○	×	×	○	×	○	×	○	○	○
287	Droop filter time constant	5F	DF	2	×	×	○	×	×	○	×	○	×	○	○	○
288	Droop function activation selection	60	E0	2	×	○	○	×	×	○	×	○	×	○	○	○
289	Inverter output terminal filter	61	E1	2	○	○	○	○	○	○	○	○	○	○	×	○
290	Monitor negative output selection	62	E2	2	○	○	○	○	○	○	○	○	○	○	○	○
291	Pulse train I/O selection	63	E3	2	○	○	○	○	×	○	○	○	×	○	×	○
292	Automatic acceleration/ deceleration	64	E4	2	Δ	Δ	Δ (x)	×	×	Δ	×	×	×	○	○	○
293	Acceleration/deceleration separate selection	65	E5	2	○	○	○ (x)	×	×	○	×	×	×	○	○	○
294	UV avoidance voltage gain	66	E6	2	○	○	○	○	×	○	○	○	×	○	○	○
295	Frequency change increment amount setting	67	E7	2	○	○	○	○	○	○	○	○	○	○	○	○

Pr.	Name	Instruction code <sup>*1</sup>			Control method <sup>*2</sup>									Parameter				
		Read	Write	Extended	V/F	Magnetic flux	Vector <sup>*3</sup>			Sensorless		PM		Copy <sup>*4</sup>	Clear <sup>*4</sup>	All clear <sup>*4</sup>		
							Speed control	Torque control	Position control	Speed control	Torque control	Speed control <sup>*7</sup>	Position control <sup>*7</sup>					
296	Password lock level	68	E8	2	○	○	○	○	○	○	○	○	○	○	○	○	○	○
297	Password lock/unlock	69	E9	2	○	○	○	○	○	○	○	○	○	○	○	○	○	○ <sup>*6</sup>
298	Frequency search gain	6A	EA	2	○	○	×	×	×	○	○	×	×	○	○	○	○	○
299	Rotation direction detection selection at restarting	6B	EB	2	○	○	×	×	×	○	×	×	×	○	○	○	○	○
300	BCD input bias <sub>[AX]</sub>	00	80	3	○	○	○	○	×	○	○	○	×	○	○	○	○	○
301	BCD input gain <sub>[AX]</sub>	01	81	3	○	○	○	○	×	○	○	○	×	○	○	○	○	○
302	BIN input bias <sub>[AX]</sub>	02	82	3	○	○	○	○	×	○	○	○	×	○	○	○	○	○
303	BIN input gain <sub>[AX]</sub>	03	83	3	○	○	○	○	×	○	○	○	×	○	○	○	○	○
304	Digital/analog input compensation enable/disable selection <sub>[AX]</sub>	04	84	3	○	○	○	○	×	○	○	○	×	○	○	○	○	○
305	Read timing operation selection <sub>[AX]</sub>	05	85	3	○	○	○	○	×	○	○	○	×	○	○	○	○	○
306	Analog output signal selection <sub>[AY]</sub>	06	86	3	○	○	○	○	○	○	○	○	○	○	○	○	○	○
307	Setting for zero analog output <sub>[AY]</sub>	07	87	3	○	○	○	○	○	○	○	○	○	○	○	○	○	○
308	Setting for maximum analog output <sub>[AY]</sub>	08	88	3	○	○	○	○	○	○	○	○	○	○	○	○	○	○
309	Analog output voltage/current signal switchover <sub>[AY]</sub>	09	89	3	○	○	○	○	○	○	○	○	○	○	○	○	○	○
310	Analog meter voltage output selection <sub>[AY]</sub>	0A	8A	3	○	○	○	○	○	○	○	○	○	○	○	○	○	○
311	Setting for zero analog meter voltage output <sub>[AY]</sub>	0B	8B	3	○	○	○	○	○	○	○	○	○	○	○	○	○	○
312	Setting for maximum analog meter voltage output <sub>[AY]</sub>	0C	8C	3	○	○	○	○	○	○	○	○	○	○	○	○	○	○
313	DO0 output selection <sub>[AY] [NC] [NCE] [NCG]</sub>	0D	8D	3	○	○	○	○	○	○	○	○	○	○	○	○	○	○
314	DO1 output selection <sub>[AY] [NC] [NCE] [NCG]</sub>	0E	8E	3	○	○	○	○	○	○	○	○	○	○	○	○	○	○
315	DO2 output selection <sub>[AY] [NC] [NCE] [NCG]</sub>	0F	8F	3	○	○	○	○	○	○	○	○	○	○	○	○	○	○
316	DO3 output selection <sub>[AY]</sub>	10	90	3	○	○	○	○	○	○	○	○	○	○	○	○	○	○
317	DO4 output selection <sub>[AY]</sub>	11	91	3	○	○	○	○	○	○	○	○	○	○	○	○	○	○
318	DO5 output selection <sub>[AY]</sub>	12	92	3	○	○	○	○	○	○	○	○	○	○	○	○	○	○
319	DO6 output selection <sub>[AY]</sub>	13	93	3	○	○	○	○	○	○	○	○	○	○	○	○	○	○
320	RA1 output selection <sub>[AR]</sub>	14	94	3	○	○	○	○	○	○	○	○	○	○	○	○	○	○
321	RA2 output selection <sub>[AR]</sub>	15	95	3	○	○	○	○	○	○	○	○	○	○	○	○	○	○
322	RA3 output selection <sub>[AR]</sub>	16	96	3	○	○	○	○	○	○	○	○	○	○	○	○	○	○
323	AM0 0 V adjustment <sub>[AY]</sub>	17	97	3	○	○	○	○	○	○	○	○	○	○	○	○	○	○
324	AM1 0 mA adjustment <sub>[AY]</sub>	18	98	3	○	○	○	○	○	○	○	○	○	○	○	○	○	○
326	Motor temperature feedback reference <sub>[AZ]</sub>	1A	9A	3	×	×	○ (x)	○ (x)	○ (x)	×	×	×	×	○	○	○	○	○
328	Inverter/converter switching <sub>[AVP]</sub>	1C	9C	3	×	×	×	×	×	×	×	×	×	×	×	×	×	×
329	Digital input unit selection <sub>[AX]</sub>	1D	9D	3	○	○	○	○	×	○	○	○	×	○	○	○	○	○
331	RS-485 communication station number	1F	9F	3	○	○	○	○	○	○	○	○	○	○	○	○	○	○ <sup>*5</sup>
332	RS-485 communication speed	20	A0	3	○	○	○	○	○	○	○	○	○	○	○	○	○	○ <sup>*5</sup>
333	RS-485 communication stop bit length / data length	21	A1	3	○	○	○	○	○	○	○	○	○	○	○	○	○	○ <sup>*5</sup>

Pr.	Name	Instruction code <sup>*1</sup>			Control method <sup>*2</sup>									Parameter		
		Read	Write	Extended	V/F	Magnetic flux	Vector <sup>*3</sup>			Sensorless		PM		Copy <sup>*4</sup>	Clear <sup>*4</sup>	All clear <sup>*4</sup>
							Speed control	Torque control	Position control	Speed control	Torque control	Speed control	Position control <sup>*7</sup>			
334	RS-485 communication parity check selection	22	A2	3	○	○	○	○	○	○	○	○	○	○	○ <sup>*5</sup>	○ <sup>*5</sup>
335	RS-485 communication retry count	23	A3	3	○	○	○	○	○	○	○	○	○	○	○ <sup>*5</sup>	○ <sup>*5</sup>
336	RS-485 communication check time interval	24	A4	3	○	○	○	○	○	○	○	○	○	○	○ <sup>*5</sup>	○ <sup>*5</sup>
337	RS-485 communication waiting time setting	25	A5	3	○	○	○	○	○	○	○	○	○	○	○ <sup>*5</sup>	○ <sup>*5</sup>
338	Communication operation command source	26	A6	3	○	○	○	○	○	○	○	○	○	○	○ <sup>*5</sup>	○ <sup>*5</sup>
339	Communication speed command source	27	A7	3	○	○	○	○	○	○	○	○	○	○	○ <sup>*5</sup>	○ <sup>*5</sup>
340	Communication startup mode selection	28	A8	3	○	○	○	○	○	○	○	○	○	○	○ <sup>*5</sup>	○ <sup>*5</sup>
341	RS-485 communication CR/LF selection	29	A9	3	○	○	○	○	○	○	○	○	○	○	○ <sup>*5</sup>	○ <sup>*5</sup>
342	Communication EEPROM write selection	2A	AA	3	○	○	○	○	○	○	○	○	○	○	○	○
343	Communication error count	2B	AB	3	○	○	○	○	○	○	○	○	○	×	×	×
345	DeviceNet address <sup>[ND]</sup>	2D	AD	3	○	○	○	○	○	○	○	○	○	○	○ <sup>*5</sup>	○ <sup>*5</sup>
346	DeviceNet baud rate <sup>[ND]</sup>	2E	AE	3	○	○	○	○	○	○	○	○	○	○	○ <sup>*5</sup>	○ <sup>*5</sup>
349	Communication reset selection/ Ready bit status selection <sup>[NC][NCE][NCG][ND][NP][NF]</sup>	31	B1	3	○	○	○	○	○	○	○	○	○	○	○ <sup>*5</sup>	○ <sup>*5</sup>
350	Stop position command selection <sup>[AP][AL][TP][APR][APS][APA]</sup>	32	B2	3	○	○	○	×	×	×	×	×	×	○	○	○
351	Orientation speed <sup>[AP][AL][TP][APR][APS][APA]</sup>	33	B3	3	○	○	○	×	×	×	×	×	×	○	○	○
352	Creep speed <sup>[AP][AL][TP][APR][APS][APA]</sup>	34	B4	3	○	○	○	×	×	×	×	×	×	○	○	○
353	Creep switchover position <sup>[AP][AL][TP][APR][APS][APA]</sup>	35	B5	3	○	○	○	×	×	×	×	×	×	○	○	○
354	Position loop switchover position <sup>[AP][AL][TP][APR][APS][APA]</sup>	36	B6	3	○	○	○	×	×	×	×	×	×	○	○	○
355	DC injection brake start position <sup>[AP][AL][TP][APR][APS][APA]</sup>	37	B7	3	○	○	○	×	×	×	×	×	×	○	○	○
356	Internal stop position command <sup>[AP][AL][TP][APR][APS][APA]</sup>	38	B8	3	○	○	○	×	×	×	×	×	×	○	○	○
357	Orientation in-position zone <sup>[AP][AL][TP][APR][APS][APA]</sup>	39	B9	3	○	○	○	×	×	×	×	×	×	○	○	○
358	Servo torque selection <sup>[AP][AL][TP][APR][APS][APA]</sup>	3A	BA	3	○	○	○	×	×	×	×	×	×	○	○	○
359	Encoder rotation direction <sup>[AP][AL][TP][APR][APS][APA]</sup>	3B	BB	3	○	○	(Δ)	○	(Δ)	×	×	×	×	○	○	○
360	16-bit data selection <sup>[AP][AL][TP][APR][APS][APA]</sup>	3C	BC	3	○	○	○	×	×	×	×	×	×	○	○	○
361	Position shift <sup>[AP][AL][TP][APR][APS][APA]</sup>	3D	BD	3	○	○	○	×	×	×	×	×	×	○	○	○
362	Orientation position loop gain <sup>[AP][AL][TP][APR][APS][APA]</sup>	3E	BE	3	○	○	○	×	×	×	×	×	×	○	○	○
363	Completion signal output delay time <sup>[AP][AL][TP][APR][APS][APA]</sup>	3F	BF	3	○	○	○	×	×	×	×	×	×	○	○	○
364	Encoder stop check time <sup>[AP][AL][TP][APR][APS][APA]</sup>	40	C0	3	○	○	○	×	×	×	×	×	×	○	○	○

Pr.	Name	Instruction code <sup>*1</sup>					Control method <sup>*2</sup>								Parameter		
		Read	Write	Extended	V/F	Magnetic flux	Vector <sup>*3</sup>			Sensorless		PM <sup>*4</sup>			Copy <sup>*4</sup>	Clear <sup>*4</sup>	All clear <sup>*4</sup>
							Speed control	Torque control	Position control	Speed control	Torque control	Speed control <sup>*7</sup>	Position control <sup>*7</sup>				
365	Orientation limit [AP] [AL] [TP] [APR] [APS] [APA]	41	C1	3	○	○	○	×	×	×	×	×	×	○	○	○	
366	Recheck time [AP] [AL] [TP] [APR] [APS] [APA]	42	C2	3	○	○	○	×	×	×	×	×	×	○	○	○	
367	Speed feedback range [AP] [AL] [TP] [APR] [APS] [APA]	43	C3	3	○	○	×	×	×	×	×	×	×	○	○	○	
368	Feedback gain [AP] [AL] [TP] [APR] [APS] [APA]	44	C4	3	○	○	×	×	×	×	×	×	×	○	○	○	
369	Number of encoder pulses [AP] [AL] [APA]	45	C5	3	○	○	○ (x)	○	○ (x)	×	×	×	×	○	○	○	
373	Encoder position tuning setting/status [AL] [APR] [APS] [APA]	49	C9	3	×	×	×	○	×	×	×	×	×	○	×	○	
374	Overspeed detection level	4A	CA	3	×	×	○	○	○	○	○	○	○	○	○	○	
376	Encoder signal loss detection enable/disable selection [AP] [AL] [APR] [APS] [APA]	4C	CC	3	×	×	○	○	○	×	×	×	○	○	○	○	
379	SSCNET III rotation direction selection [NS]	4F	CF	3	×	×	○	○	○	×	×	×	×	○	○ <sup>*5</sup>	○ <sup>*5</sup>	
380	Acceleration S-pattern 1	50	D0	3	○	○	○	○	×	○	○	○	×	○	○	○	
381	Deceleration S-pattern 1	51	D1	3	○	○	○	○	×	○	○	○	×	○	○	○	
382	Acceleration S-pattern 2	52	D2	3	○	○	○	○	×	○	○	○	×	○	○	○	
383	Deceleration S-pattern 2	53	D3	3	○	○	○	○	×	○	○	○	×	○	○	○	
384	Input pulse division scaling factor	54	D4	3	○	○	○	○	×	○	○	○	×	○	○	○	
385	Frequency for zero input pulse	55	D5	3	○	○	○	○	×	○	○	○	×	○	○	○	
386	Frequency for maximum input pulse	56	D6	3	○	○	○	○	×	○	○	○	×	○	○	○	
393	Orientation selection [AP] [AL] [TP] [APR] [APS] [APA]	5D	DD	3	×	×	○	×	×	×	×	×	×	○	○	○	
394	Number of machine side gear teeth [AP] [AL] [TP] [APR] [APA]	5E	DE	3	×	×	○	×	×	×	×	×	×	○	○	○	
395	Number of motor side gear teeth [AP] [AL] [TP] [APR] [APA]	5F	DF	3	×	×	○	×	×	×	×	×	×	○	○	○	
396	Orientation speed gain (P term) [AP] [AL] [TP] [APR] [APS] [APA]	60	E0	3	×	×	○	×	×	×	×	×	×	○	○	○	
397	Orientation speed integral time [AP] [AL] [TP] [APR] [APS] [APA]	61	E1	3	×	×	○	×	×	×	×	×	×	○	○	○	
398	Orientation speed gain (D term) [AP] [AL] [TP] [APR] [APS] [APA]	62	E2	3	×	×	○	×	×	×	×	×	×	○	○	○	
399	Orientation deceleration ratio [AP] [AL] [TP] [APR] [APS] [APA]	63	E3	3	×	×	○	×	×	×	×	×	×	○	○	○	
406	High resolution analog input selection [AZ]	06	86	○	○	○	○	○	○	○	○	○	○	○	×	○	
407	Motor temperature detection filter [AZ]	07	87	○	○	○	○	○	○	○	○	○	○	○	○	○	
408	Motor thermistor selection [AZ]	08	88	○	○	○	○	○	○	○	○	○	○	○	○	○	
413	Encoder pulse division ratio [AL]	0D	8D	4	○	○	○	○	○	○	○	○	○	○	○	○	
414	PLC function operation selection	0E	8E	4	○	○	○	○	○	○	○	○	○	○	×	×	
415	Inverter operation lock mode setting	0F	8F	4	○	○	○	○	○	○	○	○	○	○	○	○	
416	Pre-scale function selection	10	90	4	○	○	○	○	○	○	○	○	○	○	○	○	
417	Pre-scale setting value	11	91	4	○	○	○	○	○	○	○	○	○	○	○	○	
418	Extension output terminal filter [AY] [AR]	12	92	4	○	○	○	○	○	○	○	○	○	○	×	○	

Pr.	Name	Instruction code <sup>*1</sup>					Control method <sup>*2</sup>								Parameter		
		Read	Write	Extended	V/F	Magnetic flux	Vector <sup>*3</sup>			Sensorless		PM			Copy <sup>*4</sup>	Clear <sup>*4</sup>	All clear <sup>*4</sup>
							Speed control	Torque control	Position control	Speed control	Torque control	Speed control	Position control <sup>*7</sup>				
419	Position command source selection	13	93	4	x	x	x	x	o	x	x	x	o	o	o	o	
420	Command pulse scaling factor numerator (electronic gear numerator)	14	94	4	x	x	x	x	o	x	x	x	o	o	o	o	
421	Command pulse multiplication denominator (electronic gear denominator)	15	95	4	x	x	x	x	o	x	x	x	o	o	o	o	
422	Position control gain	16	96	4	x	x	x	x	o	x	x	x	o	o	o	o	
423	Position feed forward gain	17	97	4	x	x	x	x	o	x	x	x	o	o	o	o	
424	Position command acceleration/deceleration time constant	18	98	4	x	x	x	x	o	x	x	x	o	o	o	o	
425	Position feed forward command filter	19	99	4	x	x	x	x	o	x	x	x	o	o	o	o	
426	In-position width	1A	9A	4	x	x	x	x	o	x	x	x	o	o	o	o	
427	Excessive level error	1B	9B	4	x	x	x	x	o	x	x	x	o	o	o	o	
428	Command pulse selection	1C	9C	4	x	x	x	x	o	x	x	x	o	o	o	o	
429	Clear signal selection	1D	9D	4	x	x	x	x	o	x	x	x	o	o	o	o	
430	Pulse monitor selection	1E	9E	4	x	x	x	x	o	x	x	x	o	o	o	o	
432	Pulse train torque command bias <sub>AL</sub>	20	A0	4	x	x	x	o	x	x	o	x	x	o	o	o	
433	Pulse train torque command gain <sub>AL</sub>	21	A1	4	x	x	x	o	x	x	o	x	x	o	o	o	
434	Network number (CC-Link IE) <sub>NCE</sub>	22	A2	4	o	o	o	o	o	o	o	o	o	o	o <sup>*5</sup>	o <sup>*5</sup>	
	IP Address 1 <sub>NCG</sub>																
435	Station number (CC-Link IE) <sub>NCE</sub>	23	A3	4	o	o	o	o	o	o	o	o	o	o	o <sup>*5</sup>	o <sup>*5</sup>	
	IP Address 2 <sub>NCG</sub>																
436	IP address 3 <sub>NCG</sub>	24	A4	4	o	o	o	o	o	o	o	o	o	o	o <sup>*5</sup>	o <sup>*5</sup>	
437	IP address 4 <sub>NCG</sub>	25	A5	4	o	o	o	o	o	o	o	o	o	o	o <sup>*5</sup>	o <sup>*5</sup>	
438	Subnet mask 1 <sub>NCG</sub>	26	A6	4	o	o	o	o	o	o	o	o	o	o	o <sup>*5</sup>	o <sup>*5</sup>	
439	Subnet mask 2 <sub>NCG</sub>	27	A7	4	o	o	o	o	o	o	o	o	o	o	o <sup>*5</sup>	o <sup>*5</sup>	
440	Subnet mask 3 <sub>NCG</sub>	28	A8	4	o	o	o	o	o	o	o	o	o	o	o <sup>*5</sup>	o <sup>*5</sup>	
441	Subnet mask 4 <sub>NCG</sub>	29	A9	4	o	o	o	o	o	o	o	o	o	o	o <sup>*5</sup>	o <sup>*5</sup>	
446	Model position control gain	2E	AE	4	x	x	x	x	o	x	x	x	o	o	o	o	
447	Digital torque command bias <sub>AX</sub>	2F	AF	4	x	x	x	o	x	x	o	x	x	o	o	o	
448	Digital torque command gain <sub>AX</sub>	30	B0	4	x	x	x	o	x	x	o	x	x	o	o	o	
449	SSCNET III input filter setting <sub>NS</sub>	31	B1	4	x	x	o	o	o	x	x	x	o	o	o <sup>*5</sup>	o <sup>*5</sup>	
450	Second applied motor	32	B2	4	o	o	o	o	o	o	o	o	o	o	o	o	
451	Second motor control method selection	33	B3	4	o	o	o	o	o	o	o	o	o	o	o	o	
453	Second motor capacity	35	B5	4	x	o	o	o	o	o	o	o	o	o	o	o	
454	Number of second motor poles	36	B6	4	x	o	o	o	o	o	o	o	o	o	o	o	
455	Second motor excitation current	37	B7	4	x	o	o	o	o	o	o	x	x	o	x	o	
456	Rated second motor voltage	38	B8	4	x	o	o	o	o	o	o	o	x	o	o	o	
457	Rated second motor frequency	39	B9	4	x	o	o	o	o	o	o	o	o	o	o	o	
458	Second motor constant (R1)	3A	BA	4	x	o	o	o	o	o	o	o	o	o	x	o	
459	Second motor constant (R2)	3B	BB	4	x	o	o	o	o	o	o	x	x	o	x	o	

Pr.	Name	Instruction code <sup>*1</sup>			Control method <sup>*2</sup>									Parameter		
		Read	Write	Extended	V/F	Magnetic flux	Vector <sup>*3</sup>			Sensorless		PM		Copy <sup>*4</sup>	Clear <sup>*4</sup>	All clear <sup>*4</sup>
							Speed control	Torque control	Position control	Speed control	Torque control	Speed control <sup>*7</sup>	Position control <sup>*7</sup>			
460	Second motor constant (L1) / d-axis inductance (Ld)	3C	BC	4	x	o	o	o	o	o	o	o	o	o	x	o
461	Second motor constant (L2) / q-axis inductance (Lq)	3D	BD	4	x	o	o	o	o	o	o	o	o	o	x	o
462	Second motor constant (X)	3E	BE	4	x	o	o (x)	o	o (x)	o	o	x	x	o	x	o
463	Second motor auto tuning setting/status	3F	BF	4	x	o	o	o	o (x)	o	o	o	x	o	x	o
464	Digital position control sudden stop deceleration time	40	C0	4	x	x	x	x	o	x	x	x	o	o	o	o
465	First target position lower 4 digits	41	C1	4	x	x	x	x	o	x	x	x	o	o	o	o
466	First target position upper 4 digits	42	C2	4	x	x	x	x	o	x	x	x	o	o	o	o
467	Second target position lower 4 digits	43	C3	4	x	x	x	x	o	x	x	x	o	o	o	o
468	Second target position upper 4 digits	44	C4	4	x	x	x	x	o	x	x	x	o	o	o	o
469	Third target position lower 4 digits	45	C5	4	x	x	x	x	o	x	x	x	o	o	o	o
470	Third target position upper 4 digits	46	C6	4	x	x	x	x	o	x	x	x	o	o	o	o
471	Fourth target position lower 4 digits	47	C7	4	x	x	x	x	o	x	x	x	o	o	o	o
472	Fourth target position upper 4 digits	48	C8	4	x	x	x	x	o	x	x	x	o	o	o	o
473	Fifth target position lower 4 digits	49	C9	4	x	x	x	x	o	x	x	x	o	o	o	o
474	Fifth target position upper 4 digits	4A	CA	4	x	x	x	x	o	x	x	x	o	o	o	o
475	Sixth target position lower 4 digits	4B	CB	4	x	x	x	x	o	x	x	x	o	o	o	o
476	Sixth target position upper 4 digits	4C	CC	4	x	x	x	x	o	x	x	x	o	o	o	o
477	Seventh target position lower 4 digits	4D	CD	4	x	x	x	x	o	x	x	x	o	o	o	o
478	Seventh target position upper 4 digits	4E	CE	4	x	x	x	x	o	x	x	x	o	o	o	o
479	Eighth target position lower 4 digits	4F	CF	4	x	x	x	x	o	x	x	x	o	o	o	o
480	Eighth target position upper 4 digits	50	D0	4	x	x	x	x	o	x	x	x	o	o	o	o
481	Ninth target position lower 4 digits	51	D1	4	x	x	x	x	o	x	x	x	o	o	o	o
482	Ninth target position upper 4 digits	52	D2	4	x	x	x	x	o	x	x	x	o	o	o	o
483	Tenth target position lower 4 digits	53	D3	4	x	x	x	x	o	x	x	x	o	o	o	o
484	Tenth target position upper 4 digits	54	D4	4	x	x	x	x	o	x	x	x	o	o	o	o
485	Eleventh target position lower 4 digits	55	D5	4	x	x	x	x	o	x	x	x	o	o	o	o
486	Eleventh target position upper 4 digits	56	D6	4	x	x	x	x	o	x	x	x	o	o	o	o
487	Twelfth target position lower 4 digits	57	D7	4	x	x	x	x	o	x	x	x	o	o	o	o
488	Twelfth target position upper 4 digits	58	D8	4	x	x	x	x	o	x	x	x	o	o	o	o
489	Thirteenth target position lower 4 digits	59	D9	4	x	x	x	x	o	x	x	x	o	o	o	o



Pr.	Name	Instruction code <sup>*1</sup>					Control method <sup>*2</sup>								Parameter		
		Read	Write	Extended	V/F	Magnetic flux	Vector <sup>*3</sup>			Sensorless		PM			Copy <sup>*4</sup>	Clear <sup>*4</sup>	All clear <sup>*4</sup>
							Speed control	Torque control	Position control	Speed control	Torque control	Speed control	Position control <sup>*7</sup>				
490	Thirteenth target position upper 4 digits	5A	DA	4	x	x	x	x	o	x	x	x	o	o	o	o	
491	Fourteenth target position lower 4 digits	5B	DB	4	x	x	x	x	o	x	x	x	o	o	o	o	
492	Fourteenth target position upper 4 digits	5C	DC	4	x	x	x	x	o	x	x	x	o	o	o	o	
493	Fifteenth target position lower 4 digits	5D	DD	4	x	x	x	x	o	x	x	x	o	o	o	o	
494	Fifteenth target position upper 4 digits	5E	DE	4	x	x	x	x	o	x	x	x	o	o	o	o	
495	Remote output selection	5F	DF	4	o	o	o	o	o	o	o	o	o	o	o	o	
496	Remote output data 1	60	E0	4	o	o	o	o	o	o	o	o	o	x	x	x	
497	Remote output data 2	61	E1	4	o	o	o	o	o	o	o	o	o	x	x	x	
498	PLC function flash memory clear	62	E2	4	o	o	o	o	o	o	o	o	o	x	x	x	
499	SSCNET III operation selection <sup>[NS]</sup>	63	E3	4	x	x	o	o	o	x	x	x	o	o	o <sup>*5</sup>	o <sup>*5</sup>	
500	Communication error execution waiting time <sup>[NC NCE NCG ND NP NF]</sup>	00	80	5	o	o	o	o	o	o	o	o	o	o	o	o	
501	Communication error occurrence count display <sup>[NC NCE NCG ND NP NF]</sup>	01	81	5	o	o	o	o	o	o	o	o	o	x	o	o	
502	Stop mode selection at communication error	02	82	5	o	o	o	o	o	o	o	o	o	o	o	o	
503	Maintenance timer 1	03	83	5	o	o	o	o	o	o	o	o	o	x	x	x	
504	Maintenance timer 1 warning output set time	04	84	5	o	o	o	o	o	o	o	o	o	o	x	o	
505	Speed setting reference	05	85	5	o	o	o	o	o	o	o	o	o	o	o	o	
506	Display estimated main circuit capacitor residual life	06	86	5	o	o	o	o	o	o	o	o	o	x	x	x	
507	Display/reset ABC1 relay contact life	07	87	5	o	o	o	o	o	o	o	o	o	x	x	x	
508	Display/reset ABC2 relay contact life	08	88	5	o	o	o	o	o	o	o	o	o	x	x	x	
516	S-pattern time at a start of acceleration	10	90	5	o	o	o	o	x	o	o	o	x	o	o	o	
517	S-pattern time at a completion of acceleration	11	91	5	o	o	o	o	x	o	o	o	x	o	o	o	
518	S-pattern time at a start of deceleration	12	92	5	o	o	o	o	x	o	o	o	x	o	o	o	
519	S-pattern time at a completion of deceleration	13	93	5	o	o	o	o	x	o	o	o	x	o	o	o	
522	Output stop frequency	16	96	5	o	o	o	o	o	o	o	o	o	o	o	o	
539	MODBUS RTU communication check time interval	27	A7	5	o	o	o	o	o	o	o	o	o	o	o <sup>*5</sup>	o <sup>*5</sup>	
541	Frequency command sign selection <sup>[NC NCE NCG NP]</sup>	29	A9	5	o	o	o	x	x	o	x	o	x	o	o <sup>*5</sup>	o <sup>*5</sup>	
542	Communication station number (CC-Link) <sup>[NC]</sup>	2A	AA	5	o	o	o	o	o	o	o	o	o	o	o <sup>*5</sup>	o <sup>*5</sup>	
543	Baud rate selection (CC-Link) <sup>[NC]</sup>	2B	AB	5	o	o	o	o	o	o	o	o	o	o	o <sup>*5</sup>	o <sup>*5</sup>	
544	CC-Link extended setting <sup>[NC]</sup>	2C	AC	5	o	o	o	o	o	o	o	o	o	o	o <sup>*5</sup>	o <sup>*5</sup>	
547	USB communication station number	2F	AF	5	o	o	o	o	o	o	o	o	o	o	o <sup>*5</sup>	o <sup>*5</sup>	

Pr.	Name	Instruction code <sup>*1</sup>			Control method <sup>*2</sup>									Parameter		
		Read	Write	Extended	V/F	Magnetic flux	Vector <sup>*3</sup>			Sensorless		PM		Copy <sup>*4</sup>	Clear <sup>*4</sup>	All clear <sup>*4</sup>
							Speed control	Torque control	Position control	Speed control	Torque control	Speed control <sup>*7</sup>	Position control <sup>*7</sup>			
548	USB communication check time interval	30	B0	5	○	○	○	○	○	○	○	○	○	○	○ <sup>*5</sup>	○ <sup>*5</sup>
549	Protocol selection	31	B1	5	○	○	○	○	○	○	○	○	○	○	○ <sup>*5</sup>	○ <sup>*5</sup>
550	NET mode operation command source selection	32	B2	5	○	○	○	○	○	○	○	○	○	○	○ <sup>*5</sup>	○ <sup>*5</sup>
551	PU mode operation command source selection	33	B3	5	○	○	○	○	○	○	○	○	○	○	○ <sup>*5</sup>	○ <sup>*5</sup>
552	Frequency jump range	34	B4	5	○	○	○	○	×	○	○	○	×	○	○	○
553	PID deviation limit	35	B5	5	○	○	○	×	×	○	×	○	×	○	○	○
554	PID signal operation selection	36	B6	5	○	○	○	×	×	○	×	○	×	○	○	○
555	Current average time	37	B7	5	○	○	○	○	○	○	○	○	○	○	○	○
556	Data output mask time	38	B8	5	○	○	○	○	○	○	○	○	○	○	○	○
557	Current average value monitor signal output reference current	39	B9	5	○	○	○	○	○	○	○	○	○	○	○	○
560	Second frequency search gain	3C	BC	5	○	○	×	×	×	○	○	×	×	○	×	○
561	PTC thermistor protection level	3D	BD	5	○	○	○	○	○	○	○	○	○	○	×	○
563	Energization time carrying-over times	3F	BF	5	○	○	○	○	○	○	○	○	○	×	×	×
564	Operating time carrying-over times	40	C0	5	○	○	○	○	○	○	○	○	○	×	×	×
565	Second motor excitation current break point	41	C1	5	×	○	×	×	×	○	○	×	×	○	×	○
566	Second motor excitation current low-speed scaling factor	42	C2	5	×	○	×	×	×	○	○	×	×	○	×	○
569	Second motor speed control gain	45	C5	5	×	○	×	×	×	×	×	×	×	○	×	○
570	Multiple rating setting	46	C6	5	○	○	○	○	○	○	○	○	○	○	×	×
571	Holding time at a start	47	C7	5	○	○	○	○	×	○	○	○	×	○	○	○
573	4 mA input check selection	49	C9	5	○	○	○	○	×	○	○	○	×	○	○	○
574	Second motor online auto tuning	4A	CA	5	×	○	○ (x)	○	○ (x)	○	○	×	×	○	○	○
575	Output interruption detection time	4B	CB	5	○	○	○	×	×	○	×	○	×	○	○	○
576	Output interruption detection level	4C	CC	5	○	○	○	×	×	○	×	○	×	○	○	○
577	Output interruption cancel level	4D	CD	5	○	○	○	×	×	○	×	○	×	○	○	○
592	Traverse function selection	5C	DC	5	○	○	○	×	×	○	×	○	×	○	○	○
593	Maximum amplitude amount	5D	DD	5	○	○	○	×	×	○	×	○	×	○	○	○
594	Amplitude compensation amount during deceleration	5E	DE	5	○	○	○	×	×	○	×	○	×	○	○	○
595	Amplitude compensation amount during acceleration	5F	DF	5	○	○	○	×	×	○	×	○	×	○	○	○
596	Amplitude acceleration time	60	E0	5	○	○	○	×	×	○	×	○	×	○	○	○
597	Amplitude deceleration time	61	E1	5	○	○	○	×	×	○	×	○	×	○	○	○
598	Undervoltage level	62	E2	5	○	○	○ (x)	○	○ (x)	○	○	×	×	○	○	○
599	X10 terminal input selection	63	E3	5	○	○	○	○	○	○	○	○	○	○	○	○
600	First free thermal reduction frequency 1	00	80	6	○	○	○	○	○	○	○	○	○	○	○	○
601	First free thermal reduction ratio 1	01	81	6	○	○	○	○	○	○	○	○	○	○	○	○
602	First free thermal reduction frequency 2	02	82	6	○	○	○	○	○	○	○	○	○	○	○	○
603	First free thermal reduction ratio 2	03	83	6	○	○	○	○	○	○	○	○	○	○	○	○

Pr.	Name	Instruction code <sup>*1</sup>					Control method <sup>*2</sup>								Parameter		
		Read	Write	Extended	V/F	Magnetic flux	Vector <sup>*3</sup>			Sensorless		PM			Copy <sup>*4</sup>	Clear <sup>*4</sup>	All clear <sup>*4</sup>
							Speed control	Torque control	Position control	Speed control	Torque control	Speed control	Position control <sup>*7</sup>				
604	First free thermal reduction frequency 3	04	84	6	○	○	○	○	○	○	○	○	○	○	○	○	○
606	Power failure stop external signal input selection	06	86	6	○	○	○	○	×	○	○	○	×	○	○	○	
607	Motor permissible load level	07	87	6	○	○	○	○	○	○	○	○	○	○	○	○	
608	Second motor permissible load level	08	88	6	○	○	○	○	○	○	○	○	○	○	○	○	
609	PID set point/deviation input selection	09	89	6	○	○	○	×	×	○	×	○	×	○	○	○	
610	PID measured value input selection	0A	8A	6	○	○	○	×	×	○	×	○	×	○	○	○	
611	Acceleration time at a restart	0B	8B	6	○	○	○	×	×	○	×	○	×	○	○	○	
617	Reverse rotation excitation current low-speed scaling factor	11	91	6	×	○	×	×	×	○	○	×	×	○	×	○	
635	Cumulative pulse clear signal selection <input type="checkbox"/> AP <input type="checkbox"/> AL <input type="checkbox"/> TP <input type="checkbox"/> APR <input type="checkbox"/> APS <input type="checkbox"/> APA	23	A3	6	○	○	○	○	○	○	○	○	○	○	○	○	
636	Cumulative pulse division scaling factor <input type="checkbox"/> AP <input type="checkbox"/> AL <input type="checkbox"/> TP <input type="checkbox"/> APR <input type="checkbox"/> APS <input type="checkbox"/> APA	24	A4	6	○	○	○	○	○	○	○	○	○	○	○	○	
637	Control terminal option-Cumulative pulse division scaling factor <input type="checkbox"/> AP <input type="checkbox"/> AL <input type="checkbox"/> TP <input type="checkbox"/> APR <input type="checkbox"/> APS <input type="checkbox"/> APA	25	A5	6	○	○	○	○	○	○	○	○	○	○	○	○	
638	Cumulative pulse storage <input type="checkbox"/> AP <input type="checkbox"/> AL <input type="checkbox"/> TP <input type="checkbox"/> APR <input type="checkbox"/> APS <input type="checkbox"/> APA	26	A6	6	○	○	○	○	○	○	○	○	○	○	○	○	
639	Brake opening current selection	27	A7	6	×	○	○	×	×	○	×	○	×	○	○	○	
640	Brake operation frequency selection	28	A8	6	×	×	○	×	×	○	×	○	×	○	○	○	
641	Second brake sequence operation selection	29	A9	6	○	○	○	×	×	○	×	○	×	○	○	○	
642	Second brake opening frequency	2A	AA	6	○	○	○	×	×	○	×	○	×	○	○	○	
643	Second brake opening current	2B	AB	6	○	○	○	×	×	○	×	○	×	○	○	○	
644	Second brake opening current detection time	2C	AC	6	○	○	○	×	×	○	×	○	×	○	○	○	
645	Second brake operation time at start	2D	AD	6	○	○	○	×	×	○	×	○	×	○	○	○	
646	Second brake operation frequency	2E	AE	6	○	○	○	×	×	○	×	○	×	○	○	○	
647	Second brake operation time at stop	2F	AF	6	○	○	○	×	×	○	×	○	×	○	○	○	
648	Second deceleration detection function selection	30	B0	6	×	Δ	○	×	×	○	×	○	×	○	○	○	
650	Second brake opening current selection	32	B2	6	×	○	○	×	×	○	×	○	×	○	○	○	
651	Second brake operation frequency selection	33	B3	6	×	×	○	×	×	○	×	○	×	○	○	○	
653	Speed smoothing control	35	B5	6	○	×	×	×	×	×	×	×	×	○	○	○	
654	Speed smoothing cutoff frequency	36	B6	6	○	×	×	×	×	×	×	×	×	○	○	○	
655	Analog remote output selection	37	B7	6	○	○	○	○	○	○	○	○	○	○	○	○	
656	Analog remote output 1	38	B8	6	○	○	○	○	○	○	○	○	○	×	×	×	
657	Analog remote output 2	39	B9	6	○	○	○	○	○	○	○	○	○	×	×	×	
658	Analog remote output 3	3A	BA	6	○	○	○	○	○	○	○	○	○	×	×	×	



Pr.	Name	Instruction code <sup>*1</sup>					Control method <sup>*2</sup>							Parameter		
		Read	Write	Extended	V/F	Magnetic flux	Vector <sup>*3</sup>			Sensorless		PM		Copy <sup>*4</sup>	Clear <sup>*4</sup>	All clear <sup>*4</sup>
							Speed control	Torque control	Position control	Speed control	Torque control	Speed control	Position control <sup>*7</sup>			
721	Starting magnetic pole position detection pulse width	15	95	7	x	x	x	x	x	x	x	o	o	o	x	o
724	Motor inertia (exponent)	18	98	7	x	x	o	x	o	o	x	o	o	o	o	o
725	Motor protection current level	19	99	7	x	x	x (o)	x	x (o)	x	x	o	o	o	o	o
738	Second motor induced voltage constant (phi f)	26	A6	7	x	x	x (o)	x	x (o)	x	x	o	o	o	x	o
739	Second motor Ld decay ratio	27	A7	7	x	x	x (o)	x	x (o)	x	x	o	o	o	x	o
740	Second motor Lq decay ratio	28	A8	7	x	x	x (o)	x	x (o)	x	x	o	o	o	x	o
741	Second starting resistance tuning compensation	29	A9	7	x	x	x	x	x	x	x	o	o	o	x	o
742	Second motor magnetic pole detection pulse width	2A	AA	7	x	x	x	x	x	x	x	o	o	o	x	o
743	Second motor maximum frequency	2B	AB	7	x	x	x (o)	x	x (o)	x	x	o	o	o	o	o
744	Second motor inertia (integer)	2C	AC	7	x	x	o	x	o	o	x	o	o	o	o	o
745	Second motor inertia (exponent)	2D	AD	7	x	x	o	x	o	o	x	o	o	o	o	o
746	Second motor protection current level	2E	AE	7	x	x	x (o)	x	x (o)	x	x	o	o	o	o	o
747	Second motor low-speed range torque characteristic selection	2F	AF	7	x	x	x	x	x	x	x	o	o	o	o	o
750	Motor temperature detection level [AZ]	32	B2	7	o	o	o	o	o	o	o	o	o	o	o	o
751	Reference motor temperature [AZ]	33	B3	7	o	o	o	o	o	o	o	o	o	o	o	o
753	Second PID action selection	35	B5	7	o	o	o	x	x	o	x	o	x	o	o	o
754	Second PID control automatic switchover frequency	36	B6	7	o	o	o	x	x	o	x	o	x	o	o	o
755	Second PID action set point	37	B7	7	o	o	o	x	x	o	x	o	x	o	o	o
756	Second PID proportional band	38	B8	7	o	o	o	x	x	o	x	o	x	o	o	o
757	Second PID integral time	39	B9	7	o	o	o	x	x	o	x	o	x	o	o	o
758	Second PID differential time	3A	BA	7	o	o	o	x	x	o	x	o	x	o	o	o
759	PID unit selection	3B	BB	7	o	o	o	x	x	o	x	o	x	o	o	o
760	Pre-charge fault selection	3C	BC	7	o	o	o	x	x	o	x	o	x	o	o	o
761	Pre-charge ending level	3D	BD	7	o	o	o	x	x	o	x	o	x	o	o	o
762	Pre-charge ending time	3E	BE	7	o	o	o	x	x	o	x	o	x	o	o	o
763	Pre-charge upper detection level	3F	BF	7	o	o	o	x	x	o	x	o	x	o	o	o
764	Pre-charge time limit	40	C0	7	o	o	o	x	x	o	x	o	x	o	o	o
765	Second pre-charge fault selection	41	C1	7	o	o	o	x	x	o	x	o	x	o	o	o
766	Second pre-charge ending level	42	C2	7	o	o	o	x	x	o	x	o	x	o	o	o
767	Second pre-charge ending time	43	C3	7	o	o	o	x	x	o	x	o	x	o	o	o
768	Second pre-charge upper detection level	44	C4	7	o	o	o	x	x	o	x	o	x	o	o	o
769	Second pre-charge time limit	45	C5	7	o	o	o	x	x	o	x	o	x	o	o	o
774	Operation panel monitor selection 1	4A	CA	7	o	o	o	o	o	o	o	o	o	o	o	o
775	Operation panel monitor selection 2	4B	CB	7	o	o	o	o	o	o	o	o	o	o	o	o
776	Operation panel monitor selection 3	4C	CC	7	o	o	o	o	o	o	o	o	o	o	o	o

Pr.	Name	Instruction code <sup>*1</sup>			Control method <sup>*2</sup>									Parameter			
		Read	Write	Extended	V/F	Magnetic flux	Vector <sup>*3</sup>			Sensorless		PM		Copy <sup>*4</sup>	Clear <sup>*4</sup>	All clear <sup>*4</sup>	
							Speed control	Torque control	Position control	Speed control	Torque control	Speed control <sup>*7</sup>	Position control <sup>*7</sup>				
777	4 mA input fault operation frequency	4D	CD	7	○	○	○	○	○	○	○	○	○	○	○	○	○
778	4 mA input check filter	4E	CE	7	○	○	○	○	○	○	○	○	○	○	○	○	○
779	Operation frequency during communication error	4F	CF	7	○	○	○	○	○	○	○	○	○	○	○	○	○
788	Low speed range torque characteristic selection	58	D8	7	×	×	×	×	×	×	×	○	○	○	○	○	○
791	Acceleration time in low-speed range	5B	DB	7	×	×	×	×	×	×	×	○	○	○	○	○	○
792	Deceleration time in low-speed range	5C	DC	7	×	×	×	×	×	×	×	○	○	○	○	○	○
799	Pulse increment setting for output power	63	E3	7	○	○	○	○	○	○	○	○	○	○	○	○	○
800	Control method selection	00	80	8	○	○	○	○	○	○	○	○	○	○	○	○	○
802	Pre-excitation selection	02	82	8	×	×	○	×	×	×	×	×	×	○	○	○	○
803	Constant output range torque characteristic selection	03	83	8	×	×	○ (x)	○	○ (x)	○	○	×	×	○	○	○	○
804	Torque command source selection	04	84	8	×	×	○	○	×	○	○	×	×	○	○	○	○
805	Torque command value (RAM)	05	85	8	×	×	×	○	×	×	○	×	×	×	○	○	○
806	Torque command value (RAM, EEPROM)	06	86	8	×	×	×	○	×	×	○	×	×	○	○	○	○
807	Speed limit selection	07	87	8	×	×	×	○	×	×	○	×	×	○	○	○	○
808	Forward rotation speed limit/speed limit	08	88	8	×	×	×	○	×	×	○	×	×	○	○	○	○
809	Reverse rotation speed limit/reverse-side speed limit	09	89	8	×	×	×	○	×	×	○	×	×	○	○	○	○
810	Torque limit input method selection	0A	8A	8	×	×	○	○	○	○	○	○	○	○	○	○	○
811	Set resolution switchover	0B	8B	8	○	○	○	○	○	○	○	○	○	○	○	○	○
812	Torque limit level (regeneration)	0C	8C	8	×	×	○	○	○	○	○	○	○	○	○	○	○
813	Torque limit level (3rd quadrant)	0D	8D	8	×	×	○	○	○	○	○	○	○	○	○	○	○
814	Torque limit level (4th quadrant)	0E	8E	8	×	×	○	○	○	○	○	○	○	○	○	○	○
815	Torque limit level 2	0F	8F	8	×	×	○	○	○	○	○	○	○	○	○	○	○
816	Torque limit level during acceleration	10	90	8	×	×	○	○	○	○	○	○	○	○	○	○	○
817	Torque limit level during deceleration	11	91	8	×	×	○	○	○	○	○	○	○	○	○	○	○
818	Easy gain tuning response level setting	12	92	8	×	×	○	×	○	○	×	○	○	○	○	○	○
819	Easy gain tuning selection	13	93	8	×	×	○	×	○	○	×	○	○	○	×	○	○
820	Speed control P gain 1	14	94	8	×	×	○	×	○	○	×	○	○	○	○	○	○
821	Speed control integral time 1	15	95	8	×	×	○	×	○	○	×	○	○	○	○	○	○
822	Speed setting filter 1	16	96	8	×	×	○	○	×	○	○	○	×	○	○	○	○
823	Speed detection filter 1 [AP] [AL] [TP] [APR] [APS] [APA]	17	97	8	×	×	○	○	○	×	×	×	×	○	○	○	○
824	Torque control P gain 1 (current loop proportional gain)	18	98	8	×	×	○	○	○	○	○	○	○	○	○	○	○
825	Torque control integral time 1 (current loop integral time)	19	99	8	×	×	○	○	○	○	○	○	○	○	○	○	○
826	Torque setting filter 1	1A	9A	8	×	×	○	○	○	○	○	○	○	○	○	○	○
827	Torque detection filter 1	1B	9B	8	×	×	○	○	○	○	○	○	○	○	○	○	○
828	Model speed control gain	1C	9C	8	×	×	○	×	○	○	×	○	○	○	○	○	○

Pr.	Name	Instruction code <sup>*1</sup>					Control method <sup>*2</sup>								Parameter		
		Read	Write	Extended	V/F	Magnetic flux	Vector <sup>*3</sup>			Sensorless		PM			Copy <sup>*4</sup>	Clear <sup>*4</sup>	All clear <sup>*4</sup>
							Speed control	Torque control	Position control	Speed control	Torque control	Speed control	Position control <sup>*7</sup>				
829	Number of machine end encoder pulses	1D	9D	8	○	○	○	×	×	×	×	×	×	○	○	○	
830	Speed control P gain 2	1E	9E	8	×	×	○	×	○	○	×	○	○	○	○	○	
831	Speed control integral time 2	1F	9F	8	×	×	○	×	○	○	×	○	○	○	○	○	
832	Speed setting filter 2	20	A0	8	×	×	○	○	×	○	○	○	×	○	○	○	
833	Speed detection filter 2[AP AL TP APR APS APA]	21	A1	8	×	×	○	×	○	×	×	×	○	○	○	○	
834	Torque control P gain 2 (current loop proportional gain)	22	A2	8	×	×	○	○	○	○	○	○	○	○	○	○	
835	Torque control integral time 2 (current loop integral time)	23	A3	8	×	×	○	○	○	○	○	○	○	○	○	○	
836	Torque setting filter 2	24	A4	8	×	×	○	○	○	○	○	○	○	○	○	○	
837	Torque detection filter 2	25	A5	8	×	×	○	○	○	○	○	○	○	○	○	○	
838	DA1 terminal function selection[AZ]	26	A6	8	○	○	○	○	○	○	○	○	○	○	○	○	
839	DA1 output filter[AZ]	27	A7	8	○	○	○	○	○	○	○	○	○	○	○	○	
840	Torque bias selection	28	A8	8	×	×	○ (x)	×	×	○	×	×	×	○	○	○	
841	Torque bias 1	29	A9	8	×	×	○ (x)	×	×	○	×	×	×	○	○	○	
842	Torque bias 2	2A	AA	8	×	×	○ (x)	×	×	○	×	×	×	○	○	○	
843	Torque bias 3	2B	AB	8	×	×	○ (x)	×	×	○	×	×	×	○	○	○	
844	Torque bias filter	2C	AC	8	×	×	○ (x)	×	×	○	×	×	×	○	○	○	
845	Torque bias operation time	2D	AD	8	×	×	○ (x)	×	×	○	×	×	×	○	○	○	
846	Torque bias balance compensation	2E	AE	8	×	×	○ (x)	×	×	○	×	×	×	○	○	○	
847	Fall-time torque bias terminal 1 bias	2F	AF	8	×	×	○ (x)	×	×	○	×	×	×	○	○	○	
848	Fall-time torque bias terminal 1 gain	30	B0	8	×	×	○ (x)	×	×	○	×	×	×	○	○	○	
849	Analog input offset adjustment	31	B1	8	○	○	○	○	○	○	○	○	○	○	○	○	
850	Brake operation selection	32	B2	8	×	×	×	×	×	○	○	×	×	○	○	○	
851	Control terminal option-Number of encoder pulses[TP]	33	B3	8	○	○	○ (x)	○	○ (x)	×	×	×	×	○	○	○	
852	Control terminal option-Encoder rotation direction[TP]	34	B4	8	○	○	○ (x)	○	○ (x)	×	×	×	×	○	○	○	
853	Speed deviation time[AP AL TP APR APS APA]	35	B5	8	×	×	○	×	×	×	×	×	×	○	○	○	
854	Excitation ratio	36	B6	8	×	×	○ (x)	○	○ (x)	○	○	×	×	○	○	○	
855	Control terminal option-Signal loss detection enable/disable selection[TP]	37	B7	8	×	×	○ (x)	○	○ (x)	×	×	×	×	○	○	○	
857	DA1-0V adjustment[AZ]	39	B9	8	○	○	○	○	○	○	○	○	○	○	×	○	
858	Terminal 4 function assignment	3A	BA	8	○	○	○	○	○	○	○	○	○	○	×	○	
859	Torque current/Rated PM motor current	3B	BB	8	×	○	○	○	○	○	○	○	○	○	×	○	
860	Second motor torque current/Rated PM motor current	3C	BC	8	×	○	○	○	○	○	○	○	○	○	×	○	
862	Encoder option selection[AP AL TP APR APS APA]	3E	BE	8	○	○	○	○	○	×	×	×	×	○	○	○	

Pr.	Name	Instruction code <sup>*1</sup>			Control method <sup>*2</sup>									Parameter			
		Read	Write	Extended	V/F	Magnetic flux	Vector <sup>*3</sup>			Sensorless		PM		Copy <sup>*4</sup>	Clear <sup>*4</sup>	All clear <sup>*4</sup>	
							Speed control	Torque control	Position control	Speed control	Torque control	Speed control <sup>*7</sup>	Position control <sup>*7</sup>				
863	Control terminal option—Encoder pulse division ratio [TP]	3F	BF	8	○	○	○	○	○	○	○	○	○	○	○	○	○
864	Torque detection	40	C0	8	×	×	○	○	○	○	○	○	○	○	○	○	○
865	Low speed detection	41	C1	8	○	○	○	○	○	○	○	○	○	○	○	○	○
866	Torque monitoring reference	42	C2	8	×	○	○	○	○	○	○	○	○	○	○	○	○
867	AM output filter	43	C3	8	○	○	○	○	○	○	○	○	○	○	○	○	○
868	Terminal 1 function assignment	44	C4	8	○	○	○	○	○	○	○	○	○	○	×	○	○
869	Current output filter	45	C5	8	○	○	○	○	○	○	○	○	○	○	○	○	○
870	Speed detection hysteresis	46	C6	8	○	○	○	○	○	○	○	○	○	○	○	○	○
871	Control terminal option—Encoder position tuning setting/status [TP]	47	C7	8	×	×	×	×	×	×	×	×	×	○	×	○	○
872	Input phase loss protection selection	48	C8	8	○	○	○	○	○	○	○	○	○	○	○	○	○
873	Speed limit [AP] [AL] [TP] [APR] [APS] [APA]	49	C9	8	×	×	○	×	×	×	×	×	×	○	○	○	○
874	OLT level setting	4A	CA	8	×	×	○	×	○	○	×	○	○	○	○	○	○
875	Fault definition	4B	CB	8	○	○	○	○	×	○	○	○	×	○	○	○	○
876	Thermal protector input [TP]	4C	CC	8	○	○	○	○	○	○	○	○	○	○	○	○	○
877	Speed feed forward control/model adaptive speed control selection	4D	CD	8	×	×	○	×	○	○	×	○	○	○	○	○	○
878	Speed feed forward filter	4E	CE	8	×	×	○	×	○	○	×	○	○	○	○	○	○
879	Speed feed forward torque limit	4F	CF	8	×	×	○	×	○	○	×	○	○	○	○	○	○
880	Load inertia ratio	50	D0	8	×	×	○	×	○	○	×	○	○	○	×	○	○
881	Speed feed forward gain	51	D1	8	×	×	○	×	○	○	×	○	○	○	○	○	○
882	Regeneration avoidance operation selection	52	D2	8	○	○	○	×	×	○	×	○	×	○	○	○	○
883	Regeneration avoidance operation level	53	D3	8	○	○	○	×	×	○	×	○	×	○	○	○	○
884	Regeneration avoidance at deceleration detection sensitivity	54	D4	8	○	○	○	×	×	○	×	○	×	○	○	○	○
885	Regeneration avoidance compensation frequency limit value	55	D5	8	○	○	○	×	×	○	×	○	×	○	○	○	○
886	Regeneration avoidance voltage gain	56	D6	8	○	○	○	×	×	○	×	○	×	○	○	○	○
887	Control terminal option—Encoder magnetic pole position offset [TP]	57	D7	8	×	×	×	×	×	×	×	×	×	○	×	○	○
888	Free parameter 1	58	D8	8	○	○	○	○	○	○	○	○	○	○	×	×	○
889	Free parameter 2	59	D9	8	○	○	○	○	○	○	○	○	○	○	×	×	○
891	Cumulative power monitor digit shifted times	5B	DB	8	○	○	○	○	○	○	○	○	○	○	○	○	○
892	Load factor	5C	DC	8	○	○	○	○	○	○	○	○	○	○	○	○	○
893	Energy saving monitor reference (motor capacity)	5D	DD	8	○	○	○	○	○	○	○	○	○	○	○	○	○
894	Control selection during commercial power-supply operation	5E	DE	8	○	○	○	○	○	○	○	○	○	○	○	○	○
895	Power saving rate reference value	5F	DF	8	○	○	○	○	○	○	○	○	○	○	○	○	○
896	Power unit cost	60	E0	8	○	○	○	○	○	○	○	○	○	○	○	○	○
897	Power saving monitor average time	61	E1	8	○	○	○	○	○	○	○	○	○	○	○	○	○



Pr.	Name	Instruction code <sup>*1</sup>			Control method <sup>*2</sup>									Parameter			
		Read	Write	Extended	V/F	Magnetic flux	Vector <sup>*3</sup>			Sensorless		PM		Copy <sup>*4</sup>	Clear <sup>*4</sup>	All clear <sup>*4</sup>	
							Speed control	Torque control	Position control	Speed control	Torque control	Speed control	Position control <sup>*7</sup>				
898	Power saving cumulative monitor clear	62	E2	8	○	○	○	○	○	○	○	○	○	○	○	○	○
899	Operation time rate (estimated value)	63	E3	8	○	○	○	○	○	○	○	○	○	○	○	○	○
C0 (900)	FM/CA terminal calibration	5C	DC	1	○	○	○	○	○	○	○	○	○	○	○	○	○
C1 (901)	AM terminal calibration	5D	DD	1	○	○	○	○	○	○	○	○	○	○	○	○	○
C2 (902)	Terminal 2 frequency setting bias frequency	5E	DE	1	○	○	○	○	○	○	○	○	○	○	○	○	○
C3 (902)	Terminal 2 frequency setting bias	5E	DE	1	○	○	○	○	○	○	○	○	○	○	○	○	○
125 (903)	Terminal 2 frequency setting gain frequency	5F	DF	1	○	○	○	○	○	○	○	○	○	○	○	○	○
C4 (903)	Terminal 2 frequency setting gain	5F	DF	1	○	○	○	○	○	○	○	○	○	○	○	○	○
C5 (904)	Terminal 4 frequency setting bias frequency	60	E0	1	○	○	○	○	○	○	○	○	○	○	○	○	○
C6 (904)	Terminal 4 frequency setting bias	60	E0	1	○	○	○	○	○	○	○	○	○	○	○	○	○
126 (905)	Terminal 4 frequency setting gain frequency	61	E1	1	○	○	○	○	○	○	○	○	○	○	○	○	○
C7 (905)	Terminal 4 frequency setting gain	61	E1	1	○	○	○	○	○	○	○	○	○	○	○	○	○
C12 (917)	Terminal 1 bias frequency (speed)	11	91	9	×	×	○	○	○	○	○	○	○	○	○	○	○
C13 (917)	Terminal 1 bias (speed)	11	91	9	×	×	○	○	○	○	○	○	○	○	○	○	○
C14 (918)	Terminal 1 gain frequency (speed)	12	92	9	×	×	○	○	○	○	○	○	○	○	○	○	○
C15 (918)	Terminal 1 gain (speed)	12	92	9	×	×	○	○	○	○	○	○	○	○	○	○	○
C16 (919)	Terminal 1 bias command (torque/magnetic flux)	13	93	9	×	×	○	○	○	○	○	○	○	○	○	○	○
C17 (919)	Terminal 1 bias (torque/magnetic flux)	13	93	9	×	×	○	○	○	○	○	○	○	○	○	○	○
C18 (920)	Terminal 1 gain command (torque/magnetic flux)	14	94	9	×	×	○	○	○	○	○	○	○	○	○	○	○
C19 (920)	Terminal 1 gain (torque/magnetic flux)	14	94	9	×	×	○	○	○	○	○	○	○	○	○	○	○
C29 (925)	Motor temperature detection calibration (analog input) <u>[AZ]</u>	19	99	9	○	○	○	○	○	○	○	○	○	○	○	○	○
C30 (926)	Terminal 6 bias frequency (speed) <u>[AZ]</u>	1A	9A	9	○	○	○	○	○	○	○	○	○	○	○	○	○
C31 (926)	Terminal 6 bias (speed) <u>[AZ]</u>	1A	9A	9	○	○	○	○	○	○	○	○	○	○	○	○	○
C32 (927)	Terminal 6 gain frequency (speed) <u>[AZ]</u>	1B	9B	9	○	○	○	○	○	○	○	○	○	○	○	○	○
C33 (927)	Terminal 6 gain (speed) <u>[AZ]</u>	1B	9B	9	○	○	○	○	○	○	○	○	○	○	○	○	○
C34 (928)	Terminal 6 bias command (torque) <u>[AZ]</u>	1C	9C	9	×	×	○	○	○	○	○	×	×	○	○	○	○
C35 (928)	Terminal 6 bias (torque) <u>[AZ]</u>	1C	9C	9	×	×	○	○	○	○	○	×	×	○	○	○	○
C36 (929)	Terminal 6 gain command (torque) <u>[AZ]</u>	1D	9D	9	×	×	○	○	○	○	○	×	×	○	○	○	○

Pr.	Name	Instruction code <sup>*1</sup>					Control method <sup>*2</sup>								Parameter		
		Read	Write	Extended	V/F	Magnetic flux	Vector <sup>*3</sup>			Sensorless		PM <sup>*7</sup>			Copy <sup>*4</sup>	Clear <sup>*4</sup>	All clear <sup>*4</sup>
							Speed control	Torque control	Position control	Speed control	Torque control	Speed control	Position control				
C37 (929)	Terminal 6 gain (torque) <u>AZ</u>	1D	9D	9	×	×	○	○	○	○	○	○	×	×	○	×	○
C8 (930)	Current output bias signal	1E	9E	9	○	○	○	○	○	○	○	○	○	○	○	○	○
C9 (930)	Current output bias current	1E	9E	9	○	○	○	○	○	○	○	○	○	○	○	○	○
C10 (931)	Current output gain signal	1F	9F	9	○	○	○	○	○	○	○	○	○	○	○	○	○
C11 (931)	Current output gain current	1F	9F	9	○	○	○	○	○	○	○	○	○	○	○	○	○
C38 (932)	Terminal 4 bias command (torque/magnetic flux)	20	A0	9	×	×	○	○	○	○	○	○	○	○	○	×	○
C39 (932)	Terminal 4 bias (torque/magnetic flux)	20	A0	9	×	×	○	○	○	○	○	○	○	○	○	×	○
C40 (933)	Terminal 4 gain command (torque/magnetic flux)	21	A1	9	×	×	○	○	○	○	○	○	○	○	○	×	○
C41 (933)	Terminal 4 gain (torque/magnetic flux)	21	A1	9	×	×	○	○	○	○	○	○	○	○	○	×	○
C42 (934)	PID display bias coefficient	22	A2	9	○	○	○	×	×	○	×	○	×	○	○	×	○
C43 (934)	PID display bias analog value	22	A2	9	○	○	○	×	×	○	×	○	×	○	○	×	○
C44 (935)	PID display gain coefficient	23	A3	9	○	○	○	×	×	○	×	○	×	○	○	×	○
C45 (935)	PID display gain analog value	23	A3	9	○	○	○	×	×	○	×	○	×	○	○	×	○
977	Input voltage mode selection	4D	CD	9	○	○	○	○	○	○	○	○	○	○	○	×	×
989	Parameter copy alarm release	59	D9	9	○	○	○	○	○	○	○	○	○	○	○	×	○
990	PU buzzer control	5A	DA	9	○	○	○	○	○	○	○	○	○	○	○	○	○
991	PU contrast adjustment	5B	DB	9	○	○	○	○	○	○	○	○	○	○	○	×	○
992	Operation panel setting dial push monitor selection	5C	DC	9	○	○	○	○	○	○	○	○	○	○	○	○	○
994	Droop break point gain	5E	DE	9	×	○	○	×	×	○	×	○	×	○	○	○	○
995	Droop break point torque	5F	DF	9	×	○	○	×	×	○	×	○	×	○	○	○	○
997	Fault initiation	61	E1	9	○	○	○	○	○	○	○	○	○	○	×	○	○
998	PM parameter initialization	62	E2	9	○	○	○	○	○	○	○	○	○	○	○	○	○
999	Automatic parameter setting	63	E3	9	○	○	○	○	○	○	○	○	○	○	×	×	○
1000	Direct setting selection	00	80	A	○	○	○	○	○	○	○	○	○	○	○	○	○
1002	Lq tuning target current adjustment coefficient	02	82	A	×	×	×	×	×	×	×	○	×	○	○	○	○
1003	Notch filter frequency	03	83	A	×	×	○	×	○	○	×	○	○	○	○	○	○
1004	Notch filter depth	04	84	A	×	×	○	×	○	○	×	○	○	○	○	○	○
1005	Notch filter width	05	85	A	×	×	○	×	○	○	×	○	○	○	○	○	○
1006	Clock (year)	06	86	A	○	○	○	○	○	○	○	○	○	○	×	×	×
1007	Clock (month, day)	07	87	A	○	○	○	○	○	○	○	○	○	○	×	×	×
1008	Clock (hour, minute)	08	88	A	○	○	○	○	○	○	○	○	○	○	×	×	×
1015	Integral stop selection at limited frequency	0F	8F	A	○	○	○	×	×	○	×	○	×	○	○	○	○
1016	PTC thermistor protection detection time	10	90	A	○	○	○	○	○	○	○	○	○	○	○	×	○
1018	Monitor with sign selection	12	92	A	○	○	○	○	○	○	○	○	○	○	○	○	○
1019	Analog meter voltage negative output selection <u>AY</u>	13	93	A	○	○	○	○	○	○	○	○	○	○	○	○	○
1020	Trace operation selection	14	94	A	○	○	○	○	○	○	○	○	○	○	○	○	○

Pr.	Name	Instruction code <sup>*1</sup>					Control method <sup>*2</sup>							Parameter		
		Read	Write	Extended	V/F	Magnetic flux	Vector <sup>*3</sup>			Sensorless		PM		Copy <sup>*4</sup>	Clear <sup>*4</sup>	All clear <sup>*4</sup>
							Speed control	Torque control	Position control	Speed control	Torque control	Speed control	Position control <sup>*7</sup>			
1021	Trace mode selection	15	95	A	○	○	○	○	○	○	○	○	○	○	○	○
1022	Sampling cycle	16	96	A	○	○	○	○	○	○	○	○	○	○	○	○
1023	Number of analog channels	17	97	A	○	○	○	○	○	○	○	○	○	○	○	○
1024	Sampling auto start	18	98	A	○	○	○	○	○	○	○	○	○	○	○	○
1025	Trigger mode selection	19	99	A	○	○	○	○	○	○	○	○	○	○	○	○
1026	Number of sampling before trigger	1A	9A	A	○	○	○	○	○	○	○	○	○	○	○	○
1027	Analog source selection (1ch)	1B	9B	A	○	○	○	○	○	○	○	○	○	○	○	○
1028	Analog source selection (2ch)	1C	9C	A	○	○	○	○	○	○	○	○	○	○	○	○
1029	Analog source selection (3ch)	1D	9D	A	○	○	○	○	○	○	○	○	○	○	○	○
1030	Analog source selection (4ch)	1E	9E	A	○	○	○	○	○	○	○	○	○	○	○	○
1031	Analog source selection (5ch)	1F	9F	A	○	○	○	○	○	○	○	○	○	○	○	○
1032	Analog source selection (6ch)	20	A0	A	○	○	○	○	○	○	○	○	○	○	○	○
1033	Analog source selection (7ch)	21	A1	A	○	○	○	○	○	○	○	○	○	○	○	○
1034	Analog source selection (8ch)	22	A2	A	○	○	○	○	○	○	○	○	○	○	○	○
1035	Analog trigger channel	23	A3	A	○	○	○	○	○	○	○	○	○	○	○	○
1036	Analog trigger operation selection	24	A4	A	○	○	○	○	○	○	○	○	○	○	○	○
1037	Analog trigger level	25	A5	A	○	○	○	○	○	○	○	○	○	○	○	○
1038	Digital source selection (1ch)	26	A6	A	○	○	○	○	○	○	○	○	○	○	○	○
1039	Digital source selection (2ch)	27	A7	A	○	○	○	○	○	○	○	○	○	○	○	○
1040	Digital source selection (3ch)	28	A8	A	○	○	○	○	○	○	○	○	○	○	○	○
1041	Digital source selection (4ch)	29	A9	A	○	○	○	○	○	○	○	○	○	○	○	○
1042	Digital source selection (5ch)	2A	AA	A	○	○	○	○	○	○	○	○	○	○	○	○
1043	Digital source selection (6ch)	2B	AB	A	○	○	○	○	○	○	○	○	○	○	○	○
1044	Digital source selection (7ch)	2C	AC	A	○	○	○	○	○	○	○	○	○	○	○	○
1045	Digital source selection (8ch)	2D	AD	A	○	○	○	○	○	○	○	○	○	○	○	○
1046	Digital trigger channel	2E	AE	A	○	○	○	○	○	○	○	○	○	○	○	○
1047	Digital trigger operation selection	2F	AF	A	○	○	○	○	○	○	○	○	○	○	○	○
1048	Display-off waiting time	30	B0	A	○	○	○	○	○	○	○	○	○	○	○	○
1049	USB host reset	31	B1	A	○	○	○	○	○	○	○	○	○	×	○	○
1072	DC brake judgment time for anti-sway control operation	48	C8	A	○	○	○	×	×	○	×	○	×	○	○	○
1073	Anti-sway control operation selection	49	C9	A	○	○	○	×	×	○	×	○	×	○	○	○
1074	Anti-sway control frequency	4A	CA	A	○	○	○	×	×	○	×	○	×	○	○	○
1075	Anti-sway control depth	4B	CB	A	○	○	○	×	×	○	×	○	×	○	○	○
1076	Anti-sway control width	4C	CC	A	○	○	○	×	×	○	×	○	×	○	○	○
1077	Rope length	4D	CD	A	○	○	○	×	×	○	×	○	×	○	○	○
1078	Trolley weight	4E	CE	A	○	○	○	×	×	○	×	○	×	○	○	○
1079	Load weight	4F	CF	A	○	○	○	×	×	○	×	○	×	○	○	○
1103	Deceleration time at emergency stop	03	83	B	○	○	○	○	○	○	○	○	○	○	○	○
1105	Encoder magnetic pole position offset [AL] [APR] [APS] [APA]	05	85	B	×	×	×	×	×	×	×	×	×	○	×	○
1106	Torque monitor filter	06	86	B	○	○	○	○	○	○	○	○	○	○	○	○
1107	Running speed monitor filter	07	87	B	○	○	○	○	○	○	○	○	○	○	○	○
1108	Excitation current monitor filter	08	88	B	○	○	○	○	○	○	○	○	○	○	○	○
1109	PROFIBUS communication command source selection [NP]	09	89	B	×	○	○	○	○	○	○	○	○	○	○ <sup>*5</sup>	○ <sup>*5</sup>
1110	PROFIBUS format selection [NP]	0A	8A	B	○	○	○	○	○	○	○	○	○	○	○ <sup>*5</sup>	○ <sup>*5</sup>
1113	Speed limit method selection	0D	8D	B	×	×	×	○	×	×	○	×	×	○	○	○

Pr.	Name	Instruction code <sup>*1</sup>		Control method <sup>*2</sup>										Parameter		
		Read	Write	Extended	V/F	Magnetic flux	Vector <sup>*3</sup>			Sensorless		PM		Copy <sup>*4</sup>	Clear <sup>*4</sup>	All clear <sup>*4</sup>
							Speed control	Torque control	Position control	Speed control	Torque control	Speed control <sup>*7</sup>	Position control <sup>*7</sup>			
1114	Torque command reverse selection	0E	8E	B	x	x	x	o	x	x	o	x	x	o	o	o
1115	Speed control integral term clear time	0F	8F	B	x	x	o	x	o	o	x	o	o	o	o	o
1116	Constant output range speed control P gain compensation	10	90	B	x	x	o	x	o	o	x	o	o	o	o	o
1117	Speed control P gain 1 (per-unit system)	11	91	B	x	x	o	x	o	o	x	o	o	o	o	o
1118	Speed control P gain 2 (per-unit system)	12	92	B	x	x	o	x	o	o	x	o	o	o	o	o
1119	Model speed control gain (per-unit system)	13	93	B	x	x	o	x	o	o	x	o	o	o	o	o
1121	Per-unit speed control reference frequency	15	95	B	x	x	o	x	o	o	x	o	o	o	o	o
1134	PID upper limit manipulated value	22	A2	B	o	o	o	x	x	o	x	o	x	o	o	o
1135	PID lower limit manipulated value	23	A3	B	o	o	o	x	x	o	x	o	x	o	o	o
1136	Second PID display bias coefficient	24	A4	B	o	o	o	x	x	o	x	o	x	o	x	o
1137	Second PID display bias analog value	25	A5	B	o	o	o	x	x	o	x	o	x	o	x	o
1138	Second PID display gain coefficient	26	A6	B	o	o	o	x	x	o	x	o	x	o	x	o
1139	Second PID display gain analog value	27	A7	B	o	o	o	x	x	o	x	o	x	o	x	o
1140	Second PID set point/deviation input selection	28	A8	B	o	o	o	x	x	o	x	o	x	o	o	o
1141	Second PID measured value input selection	29	A9	B	o	o	o	x	x	o	x	o	x	o	o	o
1142	Second PID unit selection	2A	AA	B	o	o	o	x	x	o	x	o	x	o	o	o
1143	Second PID upper limit	2B	AB	B	o	o	o	x	x	o	x	o	x	o	o	o
1144	Second PID lower limit	2C	AC	B	o	o	o	x	x	o	x	o	x	o	o	o
1145	Second PID deviation limit	2D	AD	B	o	o	o	x	x	o	x	o	x	o	o	o
1146	Second PID signal operation selection	2E	AE	B	o	o	o	x	x	o	x	o	x	o	o	o
1147	Second output interruption detection time	2F	AF	B	o	o	o	x	x	o	x	o	x	o	o	o
1148	Second output interruption detection level	30	B0	B	o	o	o	x	x	o	x	o	x	o	o	o
1149	Second output interruption cancel level	31	B1	B	o	o	o	x	x	o	x	o	x	o	o	o
1150	PLC function user parameters 1	32	B2	B	o	o	o	o	o	o	o	o	o	o	o	o
1151	PLC function user parameters 2	33	B3	B	o	o	o	o	o	o	o	o	o	o	o	o
1152	PLC function user parameters 3	34	B4	B	o	o	o	o	o	o	o	o	o	o	o	o
1153	PLC function user parameters 4	35	B5	B	o	o	o	o	o	o	o	o	o	o	o	o
1154	PLC function user parameters 5	36	B6	B	o	o	o	o	o	o	o	o	o	o	o	o
1155	PLC function user parameters 6	37	B7	B	o	o	o	o	o	o	o	o	o	o	o	o
1156	PLC function user parameters 7	38	B8	B	o	o	o	o	o	o	o	o	o	o	o	o
1157	PLC function user parameters 8	39	B9	B	o	o	o	o	o	o	o	o	o	o	o	o
1158	PLC function user parameters 9	3A	BA	B	o	o	o	o	o	o	o	o	o	o	o	o
1159	PLC function user parameters 10	3B	BB	B	o	o	o	o	o	o	o	o	o	o	o	o
1160	PLC function user parameters 11	3C	BC	B	o	o	o	o	o	o	o	o	o	o	o	o
1161	PLC function user parameters 12	3D	BD	B	o	o	o	o	o	o	o	o	o	o	o	o

Pr.	Name	Instruction code <sup>*1</sup>			Control method <sup>*2</sup>									Parameter		
		Read	Write	Extended	V/F	Magnetic flux	Vector <sup>*3</sup>			Sensorless		PM		Copy <sup>*4</sup>	Clear <sup>*4</sup>	All clear <sup>*4</sup>
							Speed control	Torque control	Position control	Speed control	Torque control	Speed control	Position control <sup>*7</sup>			
1162	PLC function user parameters 13	3E	BE	B	o	o	o	o	o	o	o	o	o	o	o	o
1163	PLC function user parameters 14	3F	BF	B	o	o	o	o	o	o	o	o	o	o	o	o
1164	PLC function user parameters 15	40	C0	B	o	o	o	o	o	o	o	o	o	o	o	o
1165	PLC function user parameters 16	41	C1	B	o	o	o	o	o	o	o	o	o	o	o	o
1166	PLC function user parameters 17	42	C2	B	o	o	o	o	o	o	o	o	o	o	o	o
1167	PLC function user parameters 18	43	C3	B	o	o	o	o	o	o	o	o	o	o	o	o
1168	PLC function user parameters 19	44	C4	B	o	o	o	o	o	o	o	o	o	o	o	o
1169	PLC function user parameters 20	45	C5	B	o	o	o	o	o	o	o	o	o	o	o	o
1170	PLC function user parameters 21	46	C6	B	o	o	o	o	o	o	o	o	o	o	o	o
1171	PLC function user parameters 22	47	C7	B	o	o	o	o	o	o	o	o	o	o	o	o
1172	PLC function user parameters 23	48	C8	B	o	o	o	o	o	o	o	o	o	o	o	o
1173	PLC function user parameters 24	49	C9	B	o	o	o	o	o	o	o	o	o	o	o	o
1174	PLC function user parameters 25	4A	CA	B	o	o	o	o	o	o	o	o	o	o	o	o
1175	PLC function user parameters 26	4B	CB	B	o	o	o	o	o	o	o	o	o	o	o	o
1176	PLC function user parameters 27	4C	CC	B	o	o	o	o	o	o	o	o	o	o	o	o
1177	PLC function user parameters 28	4D	CD	B	o	o	o	o	o	o	o	o	o	o	o	o
1178	PLC function user parameters 29	4E	CE	B	o	o	o	o	o	o	o	o	o	o	o	o
1179	PLC function user parameters 30	4F	CF	B	o	o	o	o	o	o	o	o	o	o	o	o
1180	PLC function user parameters 31	50	D0	B	o	o	o	o	o	o	o	o	o	o	o	o
1181	PLC function user parameters 32	51	D1	B	o	o	o	o	o	o	o	o	o	o	o	o
1182	PLC function user parameters 33	52	D2	B	o	o	o	o	o	o	o	o	o	o	o	o
1183	PLC function user parameters 34	53	D3	B	o	o	o	o	o	o	o	o	o	o	o	o
1184	PLC function user parameters 35	54	D4	B	o	o	o	o	o	o	o	o	o	o	o	o
1185	PLC function user parameters 36	55	D5	B	o	o	o	o	o	o	o	o	o	o	o	o
1186	PLC function user parameters 37	56	D6	B	o	o	o	o	o	o	o	o	o	o	o	o
1187	PLC function user parameters 38	57	D7	B	o	o	o	o	o	o	o	o	o	o	o	o
1188	PLC function user parameters 39	58	D8	B	o	o	o	o	o	o	o	o	o	o	o	o
1189	PLC function user parameters 40	59	D9	B	o	o	o	o	o	o	o	o	o	o	o	o
1190	PLC function user parameters 41	5A	DA	B	o	o	o	o	o	o	o	o	o	o	o	o
1191	PLC function user parameters 42	5B	DB	B	o	o	o	o	o	o	o	o	o	o	o	o
1192	PLC function user parameters 43	5C	DC	B	o	o	o	o	o	o	o	o	o	o	o	o
1193	PLC function user parameters 44	5D	DD	B	o	o	o	o	o	o	o	o	o	o	o	o
1194	PLC function user parameters 45	5E	DE	B	o	o	o	o	o	o	o	o	o	o	o	o
1195	PLC function user parameters 46	5F	DF	B	o	o	o	o	o	o	o	o	o	o	o	o
1196	PLC function user parameters 47	60	E0	B	o	o	o	o	o	o	o	o	o	o	o	o
1197	PLC function user parameters 48	61	E1	B	o	o	o	o	o	o	o	o	o	o	o	o
1198	PLC function user parameters 49	62	E2	B	o	o	o	o	o	o	o	o	o	o	o	o
1199	PLC function user parameters 50	63	E3	B	o	o	o	o	o	o	o	o	o	o	o	o
1220	Target position/speed selection	14	94	C	x	x	x	x	o	x	x	x	o	o	o	o
1221	Start command edge detection selection	15	95	C	x	x	x	x	o	x	x	x	o	o	o	o
1222	First positioning acceleration time	16	96	C	x	x	x	x	o	x	x	x	o	o	o	o
1223	First positioning deceleration time	17	97	C	x	x	x	x	o	x	x	x	o	o	o	o
1224	First positioning dwell time	18	98	C	x	x	x	x	o	x	x	x	o	o	o	o
1225	First positioning sub-function	19	99	C	x	x	x	x	o	x	x	x	o	o	o	o
1226	Second positioning acceleration time	1A	9A	C	x	x	x	x	o	x	x	x	o	o	o	o
1227	Second positioning deceleration time	1B	9B	C	x	x	x	x	o	x	x	x	o	o	o	o
1228	Second positioning dwell time	1C	9C	C	x	x	x	x	o	x	x	x	o	o	o	o

Pr.	Name	Instruction code <sup>*1</sup>		Control method <sup>*2</sup>										Parameter		
		Read	Write	Extended	V/F	Magnetic flux	Vector <sup>*3</sup>			Sensorless		PM		Copy <sup>*4</sup>	Clear <sup>*4</sup>	All clear <sup>*4</sup>
							Speed control	Torque control	Position control	Speed control	Torque control	Speed control <sup>*7</sup>	Position control <sup>*7</sup>			
1229	Second positioning sub-function	1D	9D	C	x	x	x	x	o	x	x	x	o	o	o	o
1230	Third positioning acceleration time	1E	9E	C	x	x	x	x	o	x	x	x	o	o	o	o
1231	Third positioning deceleration time	1F	9F	C	x	x	x	x	o	x	x	x	o	o	o	o
1232	Third positioning dwell time	20	A0	C	x	x	x	x	o	x	x	x	o	o	o	o
1233	Third positioning sub-function	21	A1	C	x	x	x	x	o	x	x	x	o	o	o	o
1234	Fourth positioning acceleration time	22	A2	C	x	x	x	x	o	x	x	x	o	o	o	o
1235	Fourth positioning deceleration time	23	A3	C	x	x	x	x	o	x	x	x	o	o	o	o
1236	Fourth positioning dwell time	24	A4	C	x	x	x	x	o	x	x	x	o	o	o	o
1237	Fourth positioning sub-function	25	A5	C	x	x	x	x	o	x	x	x	o	o	o	o
1238	Fifth positioning acceleration time	26	A6	C	x	x	x	x	o	x	x	x	o	o	o	o
1239	Fifth positioning deceleration time	27	A7	C	x	x	x	x	o	x	x	x	o	o	o	o
1240	Fifth positioning dwell time	28	A8	C	x	x	x	x	o	x	x	x	o	o	o	o
1241	Fifth positioning sub-function	29	A9	C	x	x	x	x	o	x	x	x	o	o	o	o
1242	Sixth positioning acceleration time	2A	AA	C	x	x	x	x	o	x	x	x	o	o	o	o
1243	Sixth positioning deceleration time	2B	AB	C	x	x	x	x	o	x	x	x	o	o	o	o
1244	Sixth positioning dwell time	2C	AC	C	x	x	x	x	o	x	x	x	o	o	o	o
1245	Sixth positioning sub-function	2D	AD	C	x	x	x	x	o	x	x	x	o	o	o	o
1246	Seventh positioning acceleration time	2E	AE	C	x	x	x	x	o	x	x	x	o	o	o	o
1247	Seventh positioning deceleration time	2F	AF	C	x	x	x	x	o	x	x	x	o	o	o	o
1248	Seventh positioning dwell time	30	B0	C	x	x	x	x	o	x	x	x	o	o	o	o
1249	Seventh positioning sub-function	31	B1	C	x	x	x	x	o	x	x	x	o	o	o	o
1250	Eighth positioning acceleration time	32	B2	C	x	x	x	x	o	x	x	x	o	o	o	o
1251	Eighth positioning deceleration time	33	B3	C	x	x	x	x	o	x	x	x	o	o	o	o
1252	Eighth positioning dwell time	34	B4	C	x	x	x	x	o	x	x	x	o	o	o	o
1253	Eighth positioning sub-function	35	B5	C	x	x	x	x	o	x	x	x	o	o	o	o
1254	Ninth positioning acceleration time	36	B6	C	x	x	x	x	o	x	x	x	o	o	o	o
1255	Ninth positioning deceleration time	37	B7	C	x	x	x	x	o	x	x	x	o	o	o	o
1256	Ninth positioning dwell time	38	B8	C	x	x	x	x	o	x	x	x	o	o	o	o
1257	Ninth positioning sub-function	39	B9	C	x	x	x	x	o	x	x	x	o	o	o	o
1258	Tenth positioning acceleration time	3A	BA	C	x	x	x	x	o	x	x	x	o	o	o	o
1259	Tenth positioning deceleration time	3B	BB	C	x	x	x	x	o	x	x	x	o	o	o	o
1260	Tenth positioning dwell time	3C	BC	C	x	x	x	x	o	x	x	x	o	o	o	o
1261	Tenth positioning sub-function	3D	BD	C	x	x	x	x	o	x	x	x	o	o	o	o
1262	Eleventh positioning acceleration time	3E	BE	C	x	x	x	x	o	x	x	x	o	o	o	o
1263	Eleventh positioning deceleration time	3F	BF	C	x	x	x	x	o	x	x	x	o	o	o	o
1264	Eleventh positioning dwell time	40	C0	C	x	x	x	x	o	x	x	x	o	o	o	o

Pr.	Name	Instruction code <sup>*1</sup>					Control method <sup>*2</sup>							Parameter		
		Read	Write	Extended	V/F	Magnetic flux	Vector <sup>*3</sup>			Sensorless		PM		Copy <sup>*4</sup>	Clear <sup>*4</sup>	All clear <sup>*4</sup>
							Speed control	Torque control	Position control	Speed control	Torque control	Speed control	Position control <sup>*7</sup>			
1265	Eleventh positioning sub-function	41	C1	C	x	x	x	x	o	x	x	x	o	o	o	o
1266	Twelfth positioning acceleration time	42	C2	C	x	x	x	x	o	x	x	x	o	o	o	o
1267	Twelfth positioning deceleration time	43	C3	C	x	x	x	x	o	x	x	x	o	o	o	o
1268	Twelfth positioning dwell time	44	C4	C	x	x	x	x	o	x	x	x	o	o	o	o
1269	Twelfth positioning sub-function	45	C5	C	x	x	x	x	o	x	x	x	o	o	o	o
1270	Thirteenth positioning acceleration time	46	C6	C	x	x	x	x	o	x	x	x	o	o	o	o
1271	Thirteenth positioning deceleration time	47	C7	C	x	x	x	x	o	x	x	x	o	o	o	o
1272	Thirteenth positioning dwell time	48	C8	C	x	x	x	x	o	x	x	x	o	o	o	o
1273	Thirteenth positioning sub-function	49	C9	C	x	x	x	x	o	x	x	x	o	o	o	o
1274	Fourteenth positioning acceleration time	4A	CA	C	x	x	x	x	o	x	x	x	o	o	o	o
1275	Fourteenth positioning deceleration time	4B	CB	C	x	x	x	x	o	x	x	x	o	o	o	o
1276	Fourteenth positioning dwell time	4C	CC	C	x	x	x	x	o	x	x	x	o	o	o	o
1277	Fourteenth positioning sub-function	4D	CD	C	x	x	x	x	o	x	x	x	o	o	o	o
1278	Fifteenth positioning acceleration time	4E	CE	C	x	x	x	x	o	x	x	x	o	o	o	o
1279	Fifteenth positioning deceleration time	4F	CF	C	x	x	x	x	o	x	x	x	o	o	o	o
1280	Fifteenth positioning dwell time	50	D0	C	x	x	x	x	o	x	x	x	o	o	o	o
1281	Fifteenth positioning sub-function	51	D1	C	x	x	x	x	o	x	x	x	o	o	o	o
1282	Home position return method selection	52	D2	C	x	x	x	x	o	x	x	x	o	o	o	o
1283	Home position return speed	53	D3	C	x	x	x	x	o	x	x	x	o	o	o	o
1284	Home position return shifting speed	54	D4	C	x	x	x	x	o	x	x	x	o	o	o	o
1285	Home position shift amount lower 4 digits	55	D5	C	x	x	x	x	o	x	x	x	o	o	o	o
1286	Home position shift amount upper 4 digits	56	D6	C	x	x	x	x	o	x	x	x	o	o	o	o
1287	Travel distance after proximity dog ON lower 4 digits	57	D7	C	x	x	x	x	o	x	x	x	o	o	o	o
1288	Travel distance after proximity dog ON upper 4 digits	58	D8	C	x	x	x	x	o	x	x	x	o	o	o	o
1289	Home position return stopper torque	59	D9	C	x	x	x	x	o	x	x	x	o	o	o	o
1290	Home position return stopper waiting time	5A	DA	C	x	x	x	x	o	x	x	x	o	o	o	o
1292	Position control terminal input selection	5C	DC	C	x	x	x	x	o	x	x	x	o	o	o	o
1293	Roll feeding mode selection	5D	DD	C	x	x	x	x	o	x	x	x	o	o	o	o
1294	Position detection lower 4 digits	5E	DE	C	x	x	x	x	o	x	x	x	o	o	o	o
1295	Position detection upper 4 digits	5F	DF	C	x	x	x	x	o	x	x	x	o	o	o	o
1296	Position detection selection	60	E0	C	x	x	x	x	o	x	x	x	o	o	o	o
1297	Position detection hysteresis width	61	E1	C	x	x	x	x	o	x	x	x	o	o	o	o
1298	Second position control gain	62	E2	C	x	x	x	x	o	x	x	x	o	o	o	o

Pr.	Name	Instruction code <sup>*1</sup>			Control method <sup>*2</sup>										Parameter		
		Read	Write	Extended	V/F	Magnetic flux	Vector <sup>*3</sup>			Sensorless		PM		Copy <sup>*4</sup>	Clear <sup>*4</sup>	All clear <sup>*4</sup>	
							Speed control	Torque control	Position control	Speed control	Torque control	Speed control <sup>*7</sup>	Position control <sup>*7</sup>				
1299	Second pre-excitation selection	63	E3	C	x	x	o	x	x	x	x	o	x	o	o	o	
1344	R-S turns ratio compensation <sup>[AVP]</sup>	2C	AC	D	o	o	o	o	o	o	o	o	o	o	x	x	
1345	T-S turns ratio compensation <sup>[AVP]</sup>	2D	AD	D	o	o	o	o	o	o	o	o	o	o	x	x	
1348	P/PI control switchover frequency	30	B0	D	x	x	o	x	x	o	x	o	o	o	o	o	
1349	Emergency stop operation selection	31	B1	D	o	o	o	o	x	o	o	o	o	o	o	o	
1382	MC switchover interlock time (for phase-synchronized bypass switching function) <sup>[AVP]</sup>	52	D2	D	o	o	x	x	x	x	x	x	x	o	o	o	
1383	Phase compensation amount for synchronous bypass switching <sup>[AVP]</sup>	53	D3	D	o	o	x	x	x	x	x	x	x	o	o	o	
1384	PLL tuning gain <sup>[AVP]</sup>	54	D4	D	o	o	x	x	x	x	x	x	x	o	o	o	
1410	Starting times lower 4 digits	0 A	8A	E	o	o	o	o	o	o	o	o	o	x	x	x	
1411	Starting times upper 4 digits	0B	8B	E	o	o	o	o	o	o	o	o	o	x	x	x	
1412	Motor induced voltage constant (phi f) exponent	0C	8C	E	x	x	x	x	x	x	x	o	o	o	x	o	
1413	Second motor induced voltage constant (phi f) exponent	0D	8D	E	x	x	x	x	x	x	x	o	o	o	x	o	
1442	IP filter address 1 (Ethernet) <sup>[NCG]</sup>	2A	AA	E	o	o	o	o	o	o	o	o	o	o	o <sup>*5</sup>	o <sup>*5</sup>	
1443	IP filter address 2 (Ethernet) <sup>[NCG]</sup>	2B	AB	E	o	o	o	o	o	o	o	o	o	o	o <sup>*5</sup>	o <sup>*5</sup>	
1444	IP filter address 3 (Ethernet) <sup>[NCG]</sup>	2C	AC	E	o	o	o	o	o	o	o	o	o	o	o <sup>*5</sup>	o <sup>*5</sup>	
1445	IP filter address 4 (Ethernet) <sup>[NCG]</sup>	2D	AD	E	o	o	o	o	o	o	o	o	o	o	o <sup>*5</sup>	o <sup>*5</sup>	
1446	IP filter address 2 range specification (Ethernet) <sup>[NCG]</sup>	2E	AE	E	o	o	o	o	o	o	o	o	o	o	o <sup>*5</sup>	o <sup>*5</sup>	
1447	IP filter address 3 range specification (Ethernet) <sup>[NCG]</sup>	2F	AF	E	o	o	o	o	o	o	o	o	o	o	o <sup>*5</sup>	o <sup>*5</sup>	
1448	IP filter address 4 range specification (Ethernet) <sup>[NCG]</sup>	30	B0	E	o	o	o	o	o	o	o	o	o	o	o <sup>*5</sup>	o <sup>*5</sup>	
1459	Clock source selection <sup>[NCG]</sup>	3B	BB	E	o	o	o	o	o	o	o	o	o	o	o <sup>*5</sup>	o <sup>*5</sup>	
1480	Load characteristics measurement mode	50	D0	E	o	o	o	o	x	o	o	o	x	o	o	o	
1481	Load characteristics load reference 1	51	D1	E	o	o	o	o	x	o	o	o	x	o	o	o	
1482	Load characteristics load reference 2	52	D2	E	o	o	o	o	x	o	o	o	x	o	o	o	
1483	Load characteristics load reference 3	53	D3	E	o	o	o	o	x	o	o	o	x	o	o	o	
1484	Load characteristics load reference 4	54	D4	E	o	o	o	o	x	o	o	o	x	o	o	o	
1485	Load characteristics load reference 5	55	D5	E	o	o	o	o	x	o	o	o	x	o	o	o	
1486	Load characteristics maximum frequency	56	D6	E	o	o	o	o	x	o	o	o	x	o	o	o	
1487	Load characteristics minimum frequency	57	D7	E	o	o	o	o	x	o	o	o	x	o	o	o	
1488	Upper limit warning detection width	58	D8	E	o	o	o	o	x	o	o	o	x	o	o	o	
1489	Lower limit warning detection width	59	D9	E	o	o	o	o	x	o	o	o	x	o	o	o	
1490	Upper limit fault detection width	5A	DA	E	o	o	o	o	x	o	o	o	x	o	o	o	
1491	Lower limit fault detection width	5B	DB	E	o	o	o	o	x	o	o	o	x	o	o	o	



Pr.	Name	Instruction code <sup>*1</sup>			Control method <sup>*2</sup>									Parameter		
		Read	Write	Extended	V/F	Magnetic flux	Vector <sup>*3</sup>			Sensorless		PM		Copy <sup>*4</sup>	Clear <sup>*4</sup>	All clear <sup>*4</sup>
							Speed control	Torque control	Position control	Speed control	Torque control	Speed control	Position control <sup>*7</sup>			
1492	Load status detection signal delay time / load reference measurement waiting time	5C	DC	E	○	○	○	○	×	○	○	○	○	○	○	○

## 9.6 For customers using HMS network options

### ◆ List of inverter monitor items / command items

The following items can be set using a communication option.

#### 16-bit data

No.	Description	Unit	Type	Read/ write
H0000	No data	-	-	-
H0001	Output frequency	0.01 Hz	unsigned	R
H0002	Output current	0.01 A/0.1 A	unsigned	R
H0003	Output voltage	0.1 V	unsigned	R
H0004	reserved	-	-	-
H0005	Frequency setting value	0.01 Hz	unsigned	R
H0006	Motor speed	1 r/min	unsigned	R
H0007	Motor torque	0.1%	unsigned	R
H0008	Converter output voltage	0.1 V	unsigned	R
H0009	Regenerative brake duty	0.1%	unsigned	R
H000A	Electric thermal relay function load factor	0.1%	unsigned	R
H000B	Output current peak value	0.01 A/0.1 A	unsigned	R
H000C	Converter output voltage peak value	0.1 V	unsigned	R
H000D	Input power	0.01 kW/ 0.1 kW	unsigned	R
H000E	Output power	0.01 kW/ 0.1 kW	unsigned	R
H000F	Input terminal status <sup>*1</sup>	-	-	R
H0010	Output terminal status <sup>*1</sup>	-	-	R
H0011	Load meter	0.1%	unsigned	R
H0012	Motor excitation current	0.01 A/0.1 A	unsigned	R
H0013	Position pulse	1	unsigned	R/W
H0014	Cumulative energization time	1 h	unsigned	R
H0015	reserved	-	-	-
H0016	Orientation status	1	unsigned	R
H0017	Actual operation time	1 h	unsigned	R
H0018	Motor load factor	0.1%	unsigned	R
H0019	Cumulative power	1 kWh	unsigned	R
H001A	Position command (lower 16 bits)	1	signed	R
H001B	Position command (upper 16 bits)			
H001C	Current position (lower 16 bits)	1	signed	R
H001D	Current position (upper 16 bits)			
H001E	Droop pulse (lower 16 bits)	1	signed	R
H001F	Droop pulse (upper 16 bits)			
H0020	Torque order	0.1%	unsigned	R
H0021	Torque current order	0.1%	unsigned	R
H0022	Motor output	0.1 kW	unsigned	R
H0023	Feedback pulse	1	unsigned	R
H0024	reserved	-	-	-
H0025				
H0026	Trace status	-	unsigned	R
H0027	reserved	-	-	-
H0028	PLC function user monitor 1	-	unsigned	R
H0029	PLC function user monitor 2	-	unsigned	R
H002A	PLC function user monitor 3	-	unsigned	R
H002B to H002D	reserved	-	-	-
H002E	Motor temperature			R
H002F to H0031	reserved	-	-	-
H0032	Power saving effect	-	unsigned	R

No.	Description	Unit	Type	Read/ write
H0033	Cumulative saving power	-	unsigned	R
H0034	PID set point	0.1%	unsigned	R/W
H0035	PID measured value	0.1%	unsigned	R/W
H0036	PID deviation	0.1%	unsigned	R/W
H0037 to H0039	reserved	-	-	-
H003A	Option input terminal status 1 <sup>*1</sup>	-	-	R
H003B	Option input terminal status 2 <sup>*1</sup>	-	-	R
H003C	Option output terminal status <sup>*1</sup>	-	-	R
H003D	Motor thermal load factor	0.1%	unsigned	R
H003E	Transistor thermal load factor	0.1%	unsigned	R
H003F	reserved	-	-	-
H0040	PTC thermistor resistance	ohm	unsigned	R
H0041	Output power (with regenerative display)			R
H0042	Cumulative regenerative power			R
H0043	PID measured value 2			
H0044	Second PID set point	0.1%	unsigned	R/W
H0045	Second PID measured value	0.1%	unsigned	R/W
H0046	Second PID deviation	0.1%	unsigned	R/W
H0047	Cumulative pulse	1	signed	R
H0048	Cumulative pulse carrying-over times	1	signed	R
H0049	Cumulative pulse (control terminal option)	1	signed	R
H004A	Cumulative pulse carrying-over times (control terminal option)	1	signed	R
H004B	Multi-revolution counter	1	unsigned	R
H004C to H004F	reserved	-	-	-
H0050	Integrated power on time			R
H0051	Running time			R
H0052	Saving energy monitor			R
H0053	reserved	-	-	-
H0054	Fault code (1)	-	-	R
H0055	Fault code (2)	-	-	R
H0056	Fault code (3)	-	-	R
H0057	Fault code (4)	-	-	R
H0058	Fault code (5)	-	-	R
H0059	Fault code (6)	-	-	R
H005A	Fault code (7)	-	-	R
H005B	Fault code (8)	-	-	R
H005C to H005E	reserved	-	-	-
H005F	Second PID measured value 2	0.1%	unsigned	R
H0060	Second PID manipulated variable	0.1%	signed	R
H0061 to H0063	reserved	-	-	-
H0064	Current position 2 (lower 16 bits)	1	signed	R
H0065	Current position 2 (upper 16 bits)			
H0066	PID manipulated variable	0.1%	signed	R
H0067 to H00F8	reserved	-	-	-
H00F9	Run command <sup>*2</sup>	-	-	R/W
H00FA to H01FF	reserved	-	-	-

\*1 For the details, refer to [page 446](#).

\*2 Operation command

This signal is assigned in the initial status. The description changes depending on the setting of **Pr.180 to Pr.189 (Input terminal function selection)**. (Refer to [page 521](#).)

b15															b0	
-	-	-	-	RES	STP (STOP)	CS	JOG	MRS	RT	RH	RM	RL	-	-	AU	

### <32-bit data>

No.	Description	Unit	Type	Read/ write
H0200	reserved	-	-	-
H0201	Output frequency (0-15 bit)	0.01 Hz	signed	R
H0202	Output frequency (16-31 bit)			
H0203	Setting frequency (0-15 bit)	0.01 Hz	signed	R
H0204	Setting frequency (16-31 bit)			
H0205	Motor rotation (0-15 bit)	1 r/min	signed	R
H0206	Motor rotation (16-31 bit)			
H0207	Load meter (0-15 bit)	0.1%	signed	R
H0208	Load meter (16-31 bit)			
H0209	Positioning pulse (0-15 bit)	1	signed	R/W
H020A	Positioning pulse (16-31 bit)			
H020B	Watt-hour meter (1 kWh step) (0-15 bit)	1 kWh	unsigned	R
H020C	Watt-hour meter (1 kWh step) (16-31 bit)			
H020D	Watt-hour meter (0.1/0.01 kWh step) (0-15 bit)	0.1/0.01 kWh	unsigned	R
H020E	Watt-hour meter (0.1/0.01 kWh step) (16-31 bit)			
H020F	Position error (0-15 bit)	1	signed	R
H0210	Position error (16-31 bit)			
H0211	Position command (lower 16 bits)	1	signed	R
H0212	Position command (upper 16 bits)			
H0213	Current position (lower 16 bits)	1	signed	R
H0214	Current position (upper 16 bits)			
H0215 to H03FF	reserved	-	-	-

## ◆ Error reset and Ready bit status selection

- An error reset command from a communication option can be invalidated in the External operation mode or the PU operation mode.
- The status of Ready bit is selectable.

Pr.	Name	Initial value	Setting range	Description
<b>349</b>	<b>Communication reset selection/Ready bit status selection</b>	0	0, 1, 100, 101, 1000, 1001, 1100, 1101, 10000, 10001, 10100, 10101, 11000, 11001, 11100, 11101	Use this parameter to select the error reset operation, Ready bit status, and inverter reset operation when a fault is cleared.
<b>N010</b>	<b>Communication reset selection</b>	0	0	Enables the error reset function in any operation mode.
			1	Enables the error reset function only in the Network operation mode.
<b>N240</b>	<b>Ready bit status selection</b>	0	0	The status of Ready bit in communication data can be selected.
			1	
<b>N241</b>	<b>Reset selection after inverter faults are cleared</b>	0	0	The inverter is reset when a fault is cleared.
			1	The inverter is not reset when a fault is cleared.
<b>N242</b>	<b>DriveControl writing restriction selection</b>	0	0	DriveControl writing is not restricted.
			1	DriveControl writing is restricted.

- The status of Ready bit in communication data can be changed when an HMS network option is installed. (**P.N240**)
- When an HMS network option is installed and the communication option is specified for the command source in Network operation mode, it is possible to select whether the inverter is reset after the "Fault reset" command is executed. (**P.N241**)

- When an HMS network option is installed, the command source to change the DriveControl settings can be restricted to only the command source selected by **Pr.550 NET mode operation command source selection. (P.N242)**

Setting value					Description					
Pr.349	N010	N240	N241	N242	Communication reset selection <sup>*1</sup>		Ready bit status selection <sup>*2</sup>		Reset selection after inverter faults are cleared	DriveControl writing restriction
					NET operation mode	Other than NET operation mode	Main circuit: power-ON	Main circuit: power-OFF <sup>*3</sup>		
0	0	0	0	0	Reset enabled	Reset enabled	Ready bit: ON	Ready bit: ON	Reset	Not restricted
1	1	0	0	0	Reset enabled	Reset disabled	Ready bit: ON	Ready bit: ON	Reset	Not restricted
100	0	1	0	0	Reset enabled	Reset enabled	Ready bit: ON	Ready bit: OFF	Reset	Not restricted
101	1	1	0	0	Reset enabled	Reset disabled	Ready bit: ON	Ready bit: OFF	Reset	Not restricted
1000	0	0	1	0	Reset enabled	Reset enabled	Ready bit: ON	Ready bit: ON	Not reset <sup>*4</sup>	Not restricted
1001	1	0	1	0	Reset enabled	Reset disabled	Ready bit: ON	Ready bit: ON	Not reset <sup>*4</sup>	Not restricted
1100	0	1	1	0	Reset enabled	Reset enabled	Ready bit: ON	Ready bit: OFF	Not reset <sup>*4</sup>	Not restricted
1101	1	1	1	0	Reset enabled	Reset disabled	Ready bit: ON	Ready bit: OFF	Not reset <sup>*4</sup>	Not restricted
10000	0	0	0	1	Reset enabled	Reset enabled	Ready bit: ON	Ready bit: ON	Reset	Restricted <sup>*4</sup>
10001	1	0	0	1	Reset enabled	Reset disabled	Ready bit: ON	Ready bit: ON	Reset	Restricted <sup>*4</sup>
10100	0	1	0	1	Reset enabled	Reset enabled	Ready bit: ON	Ready bit: OFF	Reset	Restricted <sup>*4</sup>
10101	1	1	0	1	Reset enabled	Reset disabled	Ready bit: ON	Ready bit: OFF	Reset	Restricted <sup>*4</sup>
11000	0	0	1	1	Reset enabled	Reset enabled	Ready bit: ON	Ready bit: ON	Not reset <sup>*4</sup>	Restricted <sup>*4</sup>
11001	1	0	1	1	Reset enabled	Reset disabled	Ready bit: ON	Ready bit: ON	Not reset <sup>*4</sup>	Restricted <sup>*4</sup>
11100	0	1	1	1	Reset enabled	Reset enabled	Ready bit: ON	Ready bit: OFF	Not reset <sup>*4</sup>	Restricted <sup>*4</sup>
11101	1	1	1	1	Reset enabled	Reset disabled	Ready bit: ON	Ready bit: OFF	Not reset <sup>*4</sup>	Restricted <sup>*4</sup>

\*1 The operation mode affects the availability of communication reset.

\*2 The ON/OFF state of the power supply affects the ON/OFF state of Ready bit.

\*3 When either the external 24 V power supply or the control circuit power supply is ON.

\*4 Available when the HMS network option is installed.

## ◆ Direct command mode for position control

In the direct command mode, the target position and maximum speed can be set through communication.

Pr.	Name	Initial value	Setting range	Description
1220 B100	Target position/speed selection	0	0	Target position and maximum speed: Point table
			1	Target position: Direct command. Maximum speed: Point table.
			2	Target position and maximum speed: Direct command

- The point table is set as follows in the direct command mode. (The setting is applied when the start signal is turned ON.)

Pr.1220 setting	Target position	Maximum speed	Acceleration time	Deceleration time	Dwell time	Auxiliary function
1	Direct command	Point table 1	*1	*1	Invalid <sup>*2</sup>	*1
2	Direct command	Direct command	Pr.7	Pr.8	Invalid <sup>*2</sup>	*1

\*1 Same as the point table 1. However, even when continuous operation is set in the auxiliary function, individual operation is applied.

\*2 The direct command mode is available only for individual operation. The dwell time is invalid.

- To perform positioning operation in the direct command mode, specify the point table (RH recommended) and turn ON the start signal. (When no point table is specified, home position return operation is performed.)
- Example when **Pr.1220 = "1"**

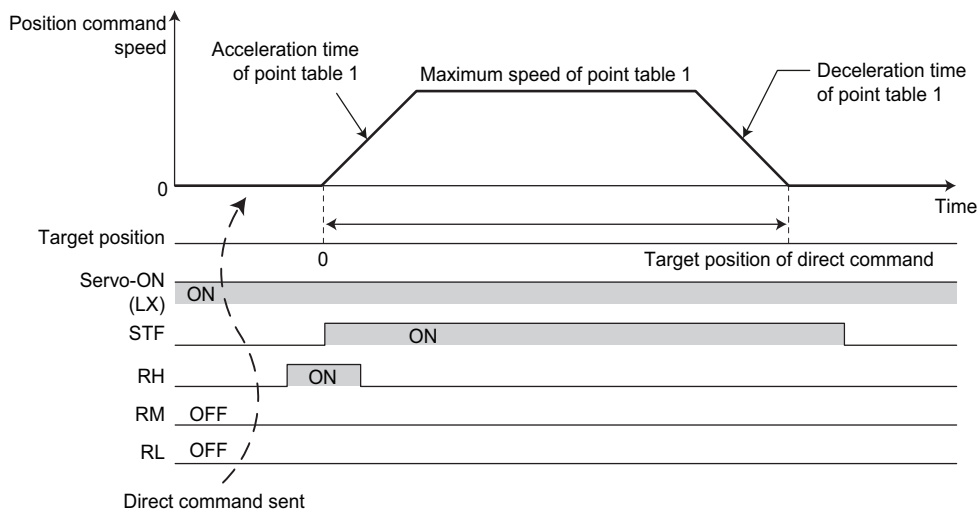

- Example when **Pr.1220 = "2"**

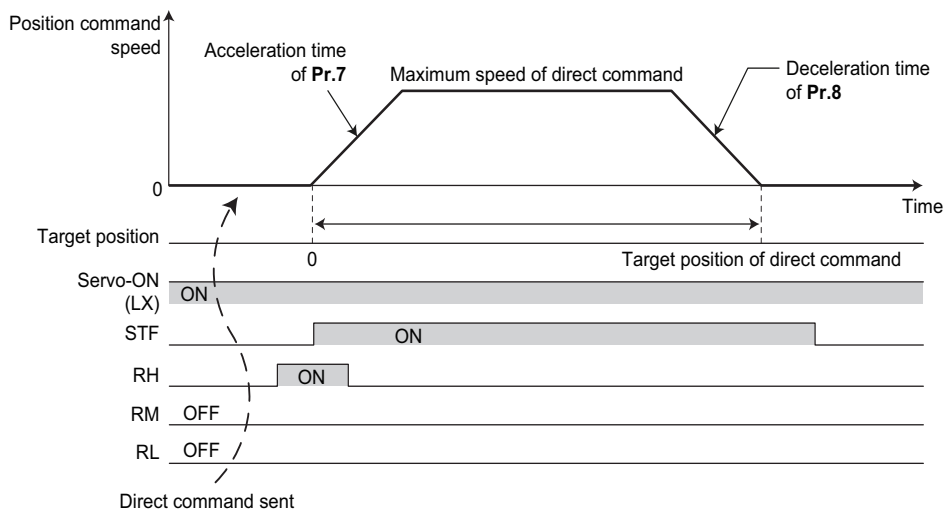

## 9.7 Ready bit status selection (Pr.349, N240)

### ◆ Error reset operation selection at inverter fault

- The status of Ready bit in communication data can be selected when a communication option (FR-A8ND or FR-A8NF) is installed.
- An error reset command from a communication option can be invalidated in the External operation mode or the PU operation mode.
- The status of Ready bit is selectable.

Pr.	Name	Initial value	Setting range	Function
349 <sup>*1</sup>	Communication reset selection/Ready bit status selection	0	0, 100	Error reset is enabled independently of operation mode.
			1, 101	Error reset is enabled in the Network operation mode.
			1001, 1000, 1100, 1101, 10000, 10001, 10100, 10101, 11000, 11001, 11100, 11101	For details, refer to <a href="#">page 893</a> .
N010 <sup>*1</sup>	Communication reset selection	0	0	Enables the error reset function in any operation mode.
			1	Enables the error reset function only in the Network operation mode.
N240 <sup>*1</sup>	Ready bit status selection	0	0	The status of Ready bit in communication data can be selected when a communication option is installed.
			1	

\*1 The setting is available only when a communication option is installed.

### ■ Ready bit status selection (P.N240)

The status of Ready bit in communication data can be selected.

Setting value			Description			
Pr.349	N010	N240	Communication reset selection		Ready bit status selection	
			NET operation mode	Other than NET operation mode	Main circuit: power-ON	Main circuit: power-OFF <sup>*1</sup>
0	0	0	Reset enabled	Reset enabled	Ready bit: ON	Ready bit: ON
1	1	0	Reset enabled	Reset disabled	Ready bit: ON	Ready bit: ON
100	0	1	Reset enabled	Reset enabled	Ready bit: ON	Ready bit: OFF
101	1	1	Reset enabled	Reset disabled	Ready bit: ON	Ready bit: OFF

\*1 When either the external 24 V power supply or the control circuit power supply is ON.

- FR-A8ND

Class 0x29 Instance 1

Attribute ID	Access	Name	Data type	Number of data bytes	Initial value	Range	Description
9	Get	Ready	BOOL	1	1	0	Other than the below
						1	Pr.349 = "0, 1" N240 = "0" During stop / during acceleration / during constant speed operation / during deceleration / during reverse rotation deceleration
							Pr.349 = "100, 101" N240 = "1" During stop while the RY signal is ON / during acceleration / during constant speed operation / during deceleration / during reverse rotation deceleration

- FR-A8NF

Inverter status monitor

Bit	Name	Description
14	READY signal	Pr.349 = "0, 1" N240 = "0" 0: During an inverter reset / during startup after power-ON. 1: During normal operation
		Pr.349 = "100, 101" N240 = "1" 0: RY signal is OFF 1: RY signal is ON

# REVISIONS

\*The manual number is given on the bottom left of the back cover.

Revision date	*Manual number	Revision
May 2013	IB(NA)-0600503ENG-A	First edition
Dec. 2013	IB(NA)-0600503ENG-B	Added <ul style="list-style-type: none"> <li>FR-A840-03250(110K) to FR-A840-06830(280K)</li> <li>IP55 compatible model</li> <li>Compatibility with FR-A8NP</li> <li>SF-PR included (<b>Pr.71 (Pr.450)</b> = "70, 73, 74")</li> <li>Anti-sway control (<b>Pr.1072 to Pr.1079</b>)</li> <li>Position control functions added (<b>Pr.1289, Pr.1290, Pr.1292 to Pr.1297</b>)</li> </ul>
Mar. 2014	IB(NA)-0600503ENG-C	Added <ul style="list-style-type: none"> <li>Separated converter type</li> </ul>
Apr. 2014	IB(NA)-0600503ENG-D	Added <ul style="list-style-type: none"> <li>Motor permissible load level (<b>Pr.607, Pr.608</b>)</li> <li>FR-A846-00023(0.4K) to FR-A846-00170(5.5K)</li> </ul>
Sep. 2014	IB(NA)-0600503ENG-E	Added <ul style="list-style-type: none"> <li>SF-PR heavy duty setting</li> <li>SF-PR slip amount adjustment mode (<b>Pr.673, Pr.674</b>)</li> <li>Addition to the power failure time deceleration-to-stop function (<b>Pr.606</b>, X48 signal, Y67 signal, and compatibility with the separated converter type)</li> <li>Addition to the self power management function (X94 signal)</li> <li>Addition to the electronic bypass sequence function (X95 signal and X96 signal)</li> <li><b>Pr.1015 Integral stop selection at limited frequency</b></li> <li><b>Pr.1016 PTC thermistor protection detection time</b></li> </ul>
Mar. 2015	IB(NA)-0600503ENG-F	Added <ul style="list-style-type: none"> <li>Second droop control (<b>Pr.679 to Pr.683</b>)</li> <li>Internal torque limit 2 (<b>Pr.810</b> = "2")</li> <li><b>Pr.1018 Monitor with sign selection</b></li> <li>Current position 2 (<b>Pr.430</b>)</li> <li>Cumulative pulse monitor value clear (<b>Pr.635 to Pr.638</b>)</li> <li>Compatibility with FR-A8TP, FR-A8APR, and FR-A8AZ</li> </ul> Edited <ul style="list-style-type: none"> <li>Availability of the brake sequence function under V/F control</li> <li>Availability of the anti-sway control under V/F control and Advanced magnetic flux vector control</li> </ul>
Aug. 2015	IB(NA)-0600503ENG-G	Added <ul style="list-style-type: none"> <li>FR-A800-GF (CC-Link IE Field Network communication function type)</li> </ul>
Oct. 2016	IB(NA)-0600503ENG-H	Added <ul style="list-style-type: none"> <li>Start count monitor (<b>Pr.1410, Pr.411</b>)</li> <li>Excitation current low-speed scaling factor (<b>Pr.14</b> = "12 to 15", <b>Pr.85, Pr.86, Pr.565, Pr.566, Pr.617</b>)</li> <li>Backup/restore function</li> <li>Input signals (CLRN, JOGF, JOGR)</li> <li>Output signal (SAFE)</li> <li>Simple position control by point table (The home position information is retained at servo-OFF.) (<b>Pr.419</b> = "10")</li> <li>MODBUS RTU communication stop bit length selection</li> <li>Continuous operation at communication error (<b>Pr.502</b> = "4")</li> </ul>
May 2017	IB(NA)-0600503ENG-J	Added <ul style="list-style-type: none"> <li>Load characteristics fault detection (<b>Pr.1480 to Pr.1492</b>)</li> <li>Droop control using the per-unit speed control reference frequency (<b>Pr.288 (Pr.681)</b> = "20 to 22")</li> <li>Torque current command limit (<b>Pr.801, Pr.803</b> = "2")</li> <li>PID manipulated amount: 0 to 100% (<b>Pr.1015</b> = "2, 12")</li> <li><b>Pr.1348 P/PI control switchover frequency</b></li> <li><b>Pr.1349 Emergency stop operation selection</b></li> <li>Operation selection at a communication error (<b>Pr.502</b> = "11, 12")</li> <li>Multi-revolution counter monitoring</li> </ul> Edited <ul style="list-style-type: none"> <li><b>Pr.275</b> setting range: 0 to 300%</li> </ul>
Oct. 2018	IB(NA)-0600503ENG-K	Added <ul style="list-style-type: none"> <li>Reset selection / disconnected PU detection / PU stop selection (<b>Pr.75</b> = "1000 to 1003, 1014 to 1017, 1100 to 1103, 1114 to 1117")</li> <li>External fault input signal (<b>Pr.178 to Pr.189</b> = "32")</li> <li>Error reset operation selection at inverter fault (<b>Pr.349</b> = "100, 101")</li> <li>PLC function (<b>Pr.414</b> = "11, 12", <b>Pr.675</b>)</li> <li>Pulse monitor selection (<b>Pr.430</b> = "2000 to 2005, 2012, 2013, 2100 to 2105, 2112, 2113, 3000 to 3005, 3012, 3013, 3100 to 3105, 3112, 3113")</li> </ul>



Revision date	*Manual number	Revision
Apr. 2020	IB(NA)-0600503ENG-L	Added <ul style="list-style-type: none"> <li>• Operation command source selection for the CS signal (<b>Pr.162</b> = "1000 to 1003, 1010 to 1013")</li> <li>• Main circuit capacitor life measurement at power OFF (every time) (<b>Pr.259</b> = "11")</li> <li>• Selecting clearing of the current position 2 monitor value (<b>Pr.419</b> = "200, 210, 300, 310, 1310")</li> <li>• <b>Pr.506 Display estimated main circuit capacitor residual life</b></li> <li>• Current input check terminal selection (<b>Pr.573</b> = "11 to 14, 21 to 24")</li> <li>• Ready bit status selection (for FR-A8ND and FR-A8NF)</li> <li>• Forward stroke end (LSP) signal, Reverse stroke end (LSN) signal</li> <li>• Low-speed forward rotation command (RLF) signal, Low-speed reverse rotation command (RLR) signal</li> <li>• Vector control for PM motor with encoder supported (for FR-A8AL and FR-A8TP)</li> <li>• Input terminal monitor (for terminals S1 and S2)</li> <li>• Reset selection after inverter faults are cleared (with the HMS network option installed)</li> </ul>
Mar. 2021	IB(NA)-0600503ENG-M	Added <ul style="list-style-type: none"> <li>• Cooling fan operation selection during the test operation (<b>Pr.244</b> = "1000, 1001, 1101 to 1105")</li> <li>• Display/reset ABC relay contact life (<b>Pr.507, Pr.508</b>)</li> <li>• DriveControl writing restriction selection (<b>Pr.349</b> = "10000, 10001, 10100, 10101, 11000, 11001, 11100, 11101")</li> </ul>

# FR-A800/A800 Plus Series

## Instruction Manual Supplement

### 1 Emergency drive



This function is used in case of emergency such as a fire to forcibly continue inverter operation to drive a motor without activating protective functions even if the inverter detects a fault. Using this function may cause damage of the motor or the inverter because driving the motor is given the highest priority. Use this function for emergency operation only. When the inverter is damaged by a fault, the motor operation can be continued by switching to the commercial power supply operation.

The emergency drive function is available only for standard structure models and IP55 compatible models.

Pr.	Name	Initial value		Setting range	Description
		FM	CA		
523 H320*1	Emergency drive mode selection	9999		100, 111, 112, 121, 122, 123, 124, 200, 211, 212, 221, 222, 223, 224, 300, 311, 312, 321, 322, 323, 324, 400, 411, 412, 421, 422, 423, 424	Select the operation mode of the emergency drive.
				9999	Emergency drive disabled.
524 H321*1*2	Emergency drive running speed	9999		0 to 590 Hz*3	Set the running frequency in the fixed frequency mode of the emergency drive (when the fixed frequency mode is selected in <b>Pr.523</b> )
				0% to 100%*3	Set the PID set point in the PID control mode of the emergency drive (when the PID control mode is selected in <b>Pr.523</b> )
				9999*3	Emergency drive disabled.
515 H322*1	Emergency drive dedicated retry count	1		1 to 200	Set the retry count during emergency drive operation.
				9999*3	Without retry count excess (no restriction on the number of retries).
1013 H323*1	Emergency drive running speed after retry reset	60 Hz	50 Hz	0 to 590 Hz	Set the frequency for operation after a retry when any of E.CPU, E.1 to E.3, and E.5 to E.7 occurs during emergency drive operation.
514 H324*1	Emergency drive dedicated waiting time	9999		0.1 to 600 s	Set the retry waiting time during emergency drive operation.
				9999	The <b>Pr.68</b> setting is applied to the operation.
136 A001	MC switchover interlock time	1 s		0 to 100 s	Set the operation interlock time for MC2 and MC3.
139 A004	Automatic switchover frequency from inverter to bypass operation	9999		0 to 60 Hz	Set the frequency at which the inverter-driven operation is switched over to the commercial power supply operation when the condition for the electronic bypass is established during emergency drive operation.
				8888, 9999	Electronic bypass during emergency drive is disabled.
57 A702	Restart coasting time	9999		0	Coasting time differs according to the inverter capacity. (Refer to the description of the automatic restart after instantaneous power failure function in the Instruction Manual (Detailed) or the Instruction Manual (Function).)
				0.1 to 30 s	Set the waiting time for the inverter to perform a restart after restoring power due to an instantaneous power failure.
				9999	No restart

\*1 The setting is available for the standard structure model and the IP55 compatible model.

\*2 Set **Pr.524** after setting **Pr.523**.

\*3 When **Pr.523** = "100, 200, 300, or 400", the emergency drive is activated regardless of the **Pr.524** setting.

## ◆ Connection diagram

- A connection diagram of the emergency drive (commercial mode) is as follows.

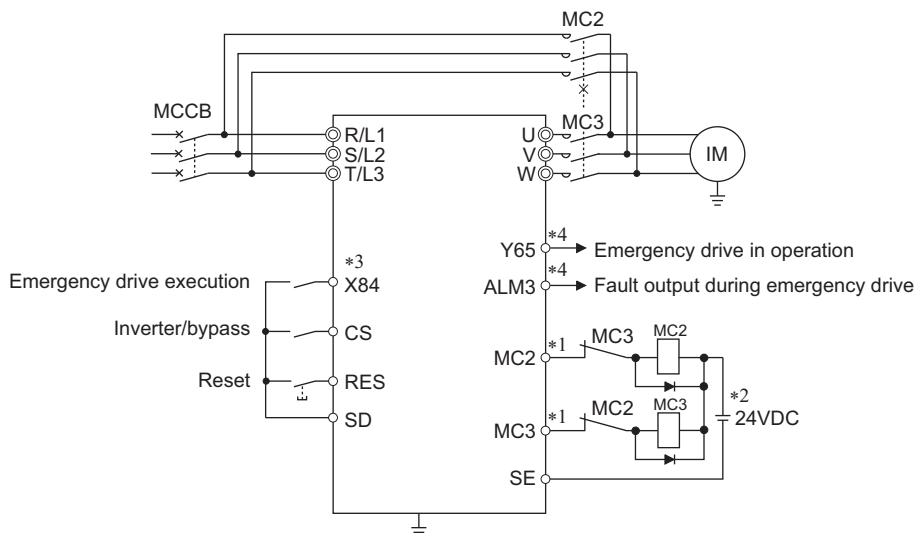

\*1 Be careful of the capacity of the sequence output terminals.

The applied terminals differ by the settings of **Pr.190 to Pr.196 (Output terminal function selection)**.

Output terminal capacity	Output terminal permissible load
Open collector output of inverter (RUN, SU, IPF, OL, FU)	24 VDC 0.1 A
Inverter relay output (A1-C1, B1-C1, A2-B2, B2-C2) Relay output option (FR-A8AR)	230 VAC 0.3 A 30 VDC 0.3 A

\*2 When connecting a DC power supply, insert a protective diode.

When connecting an AC power supply, use relay output terminals of the inverter or contact output terminals of the relay output option (FR-A8AR).

\*3 The applied terminals differ by the settings of **Pr.180 to Pr.189 (Input terminal function selection)**

\*4 The applied terminals differ by the settings of **Pr.190 to Pr.196 (Output terminal function selection)**.

### NOTE

- Be sure to provide a mechanical interlock for MC2 and MC3.

## ◆ Emergency drive execution sequence

### Point

- When the X84 signal is ON for 3 seconds, the emergency drive is activated.
- The Y65 signal turns ON during emergency drive operation.
- "ED" appears on the operation panel during emergency drive operation.
- The ALM3 signal turns ON when a fault occurs during emergency drive operation.

- To activate the emergency drive, the X84 signal needs to be ON for three seconds while all the following conditions are satisfied.

Item	Condition
Emergency drive parameter settings	<b>Pr.523</b> ≠ "9999" <b>Pr.524</b> ≠ "9999" (Setting is not required when <b>Pr.523</b> = "100, 200, 300, or 400".)
Control method	Either of the following control methods is selected (when <b>Pr.800</b> = "9, 10, 20, 109, or 110" or <b>Pr.451</b> = "10, 20, 110, or 9999") <ul style="list-style-type: none"> <li>• V/F control</li> <li>• Advanced magnetic flux vector control</li> <li>• Real sensorless vector control (speed control)</li> <li>• PM sensorless vector control (speed control)</li> <li>• PM sensorless vector control test operation</li> </ul>
Contradictory condition	None of the following conditions are satisfied. <ul style="list-style-type: none"> <li>• Enabling the electronic bypass sequence function</li> <li>• Enabling the brake sequence function</li> <li>• Using the FR-A8NS (option)</li> <li>• During offline auto tuning</li> <li>• Supplying power through terminals R1 and S1</li> <li>• <b>Pr.30</b> = "2, 102"</li> </ul>

- When the "retry" (**Pr.523** = "2□□, 3□□") is selected, it is recommended to use the automatic restart after instantaneous power failure function at the same time.
- Parameter setting is not available during emergency drive operation.
- To return to the normal operation during emergency drive operation, do the following. (The operation will not be returned to normal only by turning OFF the X84 signal.)  
Reset the inverter, or turn the power supply OFF.  
Clear a fault by turning ON the X51 signal while the sequence function is enabled (when the protective function is activated).
- The operation is switched over to the commercial power supply operation in case of the following during emergency drive operation while the commercial mode or the retry / commercial mode is selected.  
24 V external power supply operation, power failure status or operation with the power supplied through R1/S1 (except when the DC feeding mode 1 or 2 is selected), undervoltage
- To input the X84 signal, set "84" in any of **Pr.178 to Pr.189 (Input terminal function selection)** to assign the function.
- For the terminal used for the Y65 signal output, assign the function by setting "65 (positive logic)" or "165 (negative logic)" in any of **Pr.190 to Pr.196 (Output terminal function selection)**. For the terminal used for the ALM3 signal output, assign the function by setting "66 (positive logic)" or "166 (negative logic)" in any of **Pr.190 to Pr.196 (Output terminal function selection)**.
- The X84 signal input is valid either through the external terminal or via network regardless of the **Pr.338** and **Pr.339** settings (Selection of control source in Network operation mode).
- During emergency drive operation, the operation is performed as **Pr.502 Stop mode selection at communication error** = "0 (initial value)" and communication errors (such as E.SER) do not occur. (A protective function is performed according to its operation during emergency drive operation.)

- The following diagram shows the operation of the emergency drive function (in the retry / output shutoff mode or in the fixed frequency mode (**Pr.523** = "211")).

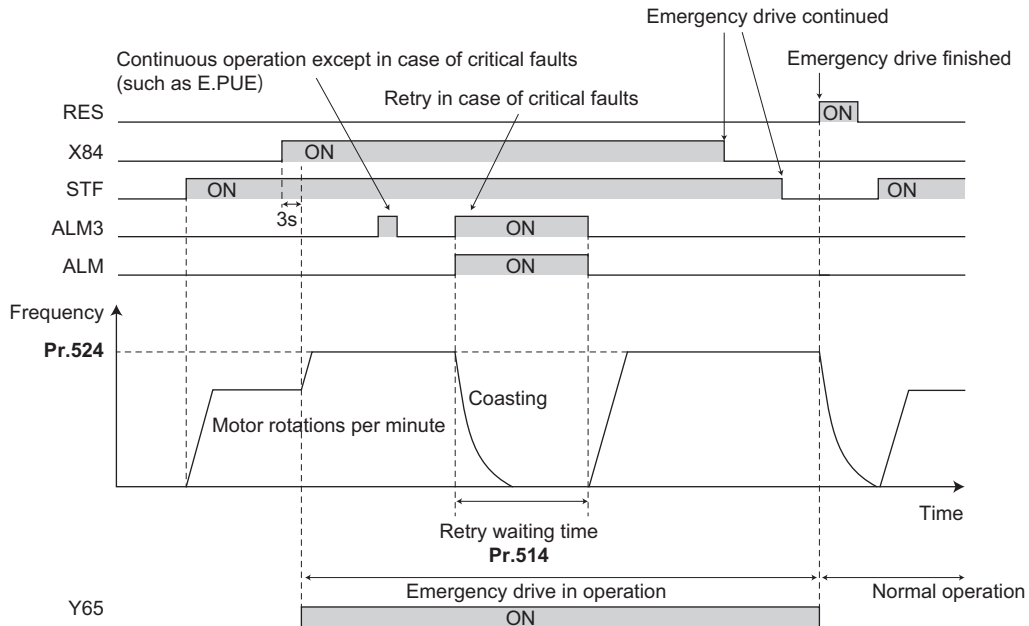

- The following diagram shows the operation of switching over to the commercial power supply operation during emergency drive operation by using the CS signal (when the electronic bypass during emergency drive operation is enabled) (in the commercial mode or in the fixed frequency mode (**Pr.523** = "411")).

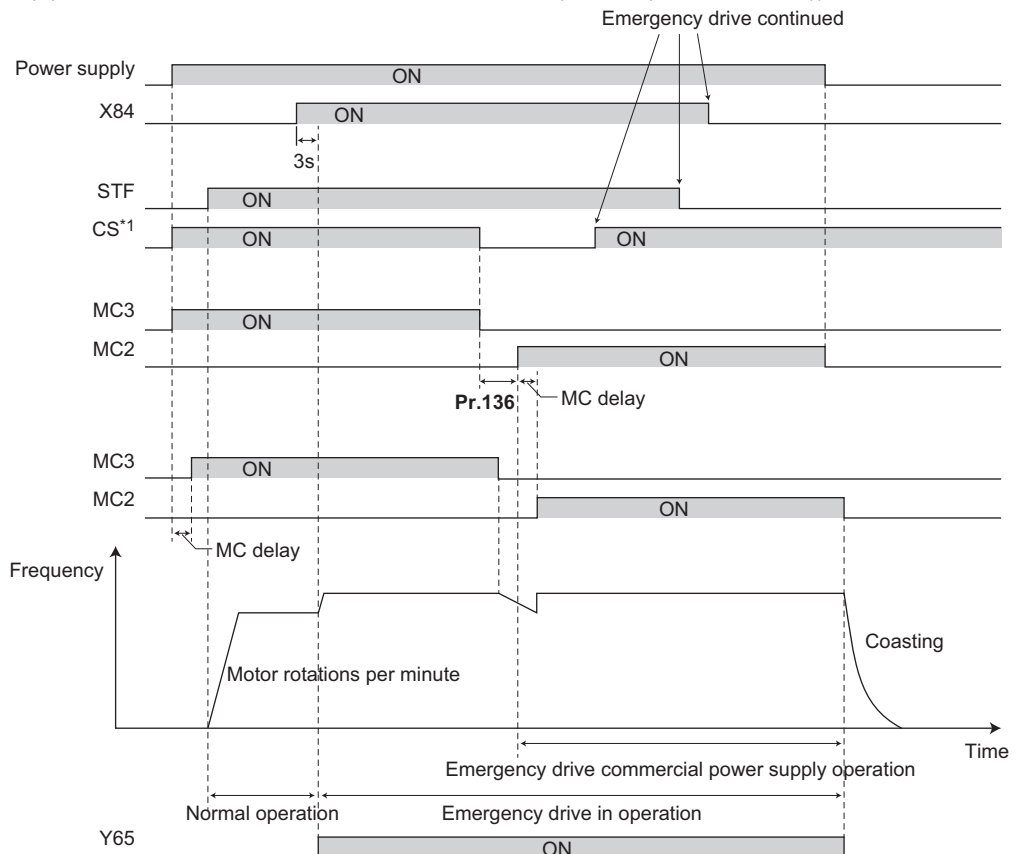

\*1 Input the CS signal via an external terminal.

**NOTE**

- The emergency drive function is not available for the FR-A800-CRN and FR-B, B3 series inverters.

## ◆ Emergency drive operation selection (Pr.523, Pr.524)

- Use **Pr.523 Emergency drive mode selection** to select the emergency drive operation. Set a value in the hundreds place to select the operation when a valid protective function is activated (critical fault) during emergency drive. Set values in the ones and tens places to select the operation method.

Pr.523 setting	Emergency drive operation mode		Description
100	Output shutoff mode		Output shutoff at a critical fault occurrence.
200	Retry / output shutoff mode		Retry operation at a critical fault occurrence. (Output shutoff at the occurrence of a fault for which retry is not permitted.) The output is shut off when a critical fault for which retry is not permitted occurs, or the retry count is exceeded.
300 <sup>*1</sup>	Retry / commercial mode		Retry operation at a critical fault occurrence. (Electronic bypass at the occurrence of a critical fault for which retry is not permitted.) The operation is switched over to the commercial power supply operation when a critical fault for which retry is not permitted occurs, or the retry count is exceeded. While <b>Pr.515</b> = "9999", the operation is switched over to the commercial power supply operation when the retry count reaches 200.
400 <sup>*1</sup>	Commercial mode		The operation is switched over to the commercial power supply operation when a critical fault occurs.
000	Normal operation		The operation is performed with the same set frequency and by the same starting command as those in the normal operation. Use this mode to avoid output shutoff due to a fault.
011	Fixed frequency mode	Forward rotation	The operation is forcibly performed with the frequency set in <b>Pr.524</b> . Even when the motor is stopped, the operation is started by the emergency drive operation.
012		Reverse rotation	
021	PID control mode	Forward rotation	The operation is performed under PID control using the <b>Pr.524</b> setting as a set point. The measured values are input in the method set in <b>Pr.128</b> .
022		Reverse rotation	
023		Forward rotation (Second PID measured value input)	The operation is performed under PID control using the <b>Pr.524</b> setting as a set point. The measured values are input in the method set in <b>Pr.753</b> .
024		Reverse rotation (Second PID measured value input)	
9999	Emergency drive disabled.		

\*1 Under PM sensorless vector control, the operation is not switched over to the commercial power supply operation and the output is shut off.

### NOTE

- The operation is automatically switched from the PU operation mode or External/PU combined operation mode to the External operation mode when the emergency drive is activated in the fixed frequency mode or in the PID control mode.

## ◆ Retry operation during emergency drive (Pr.515, Pr.514)

- Set the retry operation during emergency drive operation. Use **Pr.515 Emergency drive dedicated retry count** to set the retry count, and use **Pr.514 Emergency drive dedicated waiting time** to set the retry waiting time.
- The ALM signal output conditions depend on the **Pr.67 Number of retries at fault occurrence** setting. (Refer to the description of the retry function in the Instruction Manual (Detailed) or the Instruction Manual (Function).)
- For the protective functions (critical faults) for which a retry is performed during emergency drive operation, refer to [page 7](#).

### NOTE

- During emergency drive operation, **Pr.65 Retry selection** is not available.

## ◆ Electronic bypass during emergency drive (Pr.136, Pr.139, Pr.57)

- For selecting the commercial mode (Pr.523 = "3□□, 4□□"), setting is required as follows.  
Set **Pr.136 MC switchover interlock time** and **Pr.139 Automatic switchover frequency from inverter to bypass operation** and assign MC2 and MC3 signals to output terminals.  
When the CS signal is assigned to an input terminal, set **Pr.57 Restart coasting time** ≠ "9999" and input the CS signal through the terminal. (In the initial setting, the CS signal is assigned to the terminal CS.)  
Select V/F control, Advanced magnetic flux vector control, or Real sensorless vector control. (Under PM sensorless vector control, the operation is not switched over to the commercial power supply operation the output is shut off.)
- During emergency drive operation, the operation is switched over to the commercial power supply operation when any of the following conditions is satisfied.  
CS signal turns OFF.  
A critical fault for which retry is not permitted occurs while **Pr.523** = "3□□".  
A critical fault occurs while **Pr.523** = "4□□".
- While the motor is driven by the inverter during emergency drive operation, if a condition for electronic bypass is satisfied, the output frequency is accelerated/decelerated to the **Pr.139** setting. When the frequency reaches the set frequency, the operation is switched over to the commercial power supply operation. (The operation is immediately switched over to the commercial power supply operation during output shutoff due to a critical fault occurrence.)
- If the parameter for electronic bypass is not set while the commercial mode is set (**Pr.523** = "3□□, 4□□"), the operation is not switched over to the commercial power supply operation even when a condition for switchover is satisfied, and the output is shut off.
- To assign the MC2 and MC3 signals to output terminals, use any two of **Pr.190 to Pr.196 (Output terminal function selection)** and set "18 (positive logic)" for the MC2 signal and set "19 (positive logic)" for the MC3 signal.
- Operation of magnetic contactor (MC2, MC3)

Magnetic contactor	Installation location	Operation	
		During commercial power supply operation	During inverter operation
MC2	Between power supply and motor	Shorted	Open
MC3	Between inverter output side and motor	Open	Shorted

- The input signals are as follows.

Signal	Function	Operation	MC operation <sup>*4</sup>	
			MC2	MC3
CS <sup>*1</sup>	Inverter/bypass	ON: Inverter operation	×	○
		OFF: Emergency drive commercial power supply operation <sup>*2</sup>	○	×
X84	Emergency drive operation	ON: Emergency drive operation	—	—
		OFF: Normal operation <sup>*3</sup>	×	○
RES	Operation status reset	ON: Reset	×	No change
		OFF: Normal operation	—	—

\*1 Input the CS signal via an external terminal. (Set **Pr.162** = "0 to 3, 10 to 13" or **Pr.338** = "1".)

\*2 If the signal is turned ON after switchover to the emergency drive commercial power supply operation, the operation will not be returned to the inverter-driven operation.

\*3 If the signal is turned OFF during the emergency drive operation, the operation will not be returned to normal.

\*4 MC operation is as follows.

Notation	MC operation
○	ON
×	OFF
—	During inverter operation: MC2-OFF, MC3-ON During commercial power supply operation: MC2-ON, MC3-OFF
No change	The operation status before changing the signal state to ON or OFF is held.

### NOTE

- During electronic bypass operation while the electronic bypass sequence is enabled (**Pr.135** = "1"), the emergency drive function is not available.

## ◆ PID control during emergency drive operation

- During emergency drive operation in the PID control mode, the operation is performed under PID control using the **Pr.524** setting as a set point. Input the measured values in the method set in **Pr.128** or **Pr.753**.
- When the PID control mode is selected for emergency drive, the PID action during emergency drive operation is as follows depending on the PID control setting.

Item	PID control action		
	Set point / measured value input setting	Deviation input setting	Without PID control setting
Measured value input selection ( <b>Pr.128, Pr.753</b> )	Held	Terminal 4 input	Terminal 4 input
Forward action / reverse action selection ( <b>Pr.128, Pr.753</b> )	Held	Held	Reverse action
Proportional band ( <b>Pr.129, Pr.756</b> )	Held	Held	100% (initial value)
Integral time ( <b>Pr.130, Pr.757</b> )	Held	Held	1 s (initial setting)
Differential time ( <b>Pr.134, Pr.758</b> )	Held	Held	Not used (initial setting)
Applied to the frequency / calculation only ( <b>Pr.128, Pr.753</b> )	Applied to the frequency	Applied to the frequency	Applied to the frequency
Dancer control	Invalid	Invalid	Invalid
Other PID-related settings	Held	Held	Held

- While the "retry" (**Pr.523** = "22[, 32[") is selected in the PID control mode, if a retry occurs at an occurrence of E.CPU, E.1 to E.3, or E.5 to E.7 during emergency drive operation, the operation is performed not under PID control but with the fixed frequency.

Use **Pr.1013 Emergency drive running speed after retry reset** to set the fixed frequency.

## ◆ Operation of protective functions during emergency drive

- Operation of protective functions during emergency drive is as follows.

Protective function	Operation during emergency drive	Protective function	Operation during emergency drive	Protective function	Operation during emergency drive
E.OC1	Retry	E.OP3	The function is disabled.	E.ECA	The function is disabled.
E.OC2	Retry	E.16	The function is disabled.	E.MB1	The function is disabled.
E.OC3	Retry	E.17	The function is disabled.	E.MB2	The function is disabled.
E.OV1	Retry	E.18	The function is disabled.	E.MB3	The function is disabled.
E.OV2	Retry	E.19	The function is disabled.	E.MB4	The function is disabled.
E.OV3	Retry	E.20	The function is disabled.	E.MB5	The function is disabled.
E.THT	Retry	E.PE	Output shutoff	E.MB6	The function is disabled.
E.THM	Retry	E.PUE	The function is disabled.	E.MB7	The function is disabled.
E.FIN	Retry	E.RET	Output shutoff	E.EP	The function is disabled.
E.IPF	The function is disabled.	E.PE2	Output shutoff	E.MP	The function is disabled.
E.UVT	The function is disabled.	E.CPU	Retry	E.EF	The function is disabled.
E.ILF	The function is disabled.	E.CTE	The function is disabled.	E.IAH	The function is disabled.
E.OLT	Retry	E.P24	The function is disabled.	E.LCI	The function is disabled.
E.SOT	Retry	E.CDO	Retry	E.PCH	The function is disabled.
E.LUP	The function is disabled.	E.IOH	Output shutoff	E.PID	The function is disabled.
E.LDN	The function is disabled.	E.SER	The function is disabled.	E.1	Retry <sup>*2</sup>
E.BE	Retry <sup>*1</sup>	E.AIE	The function is disabled.	E.2	Retry <sup>*2</sup>
E.GF	Retry	E.USB	The function is disabled.	E.3	Retry <sup>*2</sup>
E.LF	The function is disabled.	E.SAF	Retry <sup>*1</sup>	E.5	Retry <sup>*2</sup>
E.OHT	Retry	E.PBT	Retry <sup>*1</sup>	E.6	Retry <sup>*1*2</sup>
E.PTC	Retry	E.OS	The function is disabled.	E.7	Retry <sup>*1*2</sup>
E.OPT	The function is disabled.	E.OSD	The function is disabled.	E.11	The function is disabled.
E.OP1	The function is disabled.	E.ECT	The function is disabled.	E.13	Output shutoff
E.OP2	The function is disabled.	E.OD	The function is disabled.		

\*1 While the switchover to the commercial power supply operation during emergency drive operation is enabled, when the same protective function is activated twice consecutively, the retry is attempted up to twice.

\*2 In normal operation (**Pr.523** = "200 or 300"), the start signal is turned OFF at the same time the retry function resets the protective function. Input the start signal again to resume the operation.



- The fault output during emergency drive operation is as follows.

Signal	Pr.190 to Pr.196 setting		Description
	Positive logic	Negative logic	
ALM	99	199	Turns ON at the occurrence of a fault that causes the above-mentioned "retry" or "output shutoff" during emergency drive operation.
ALM3	66	166	Output when a fault occurs during emergency drive operation. During emergency drive operation, if a fault that does not activate any protective function occurs, the signal turns ON for 3 seconds and then turns OFF.

## ◆ Input signal operation

- During emergency drive operation in the fixed frequency mode or in the PID control mode, input signals unrelated to the emergency drive become invalid with some exceptions.
- The following table shows functions of the signals that do not become invalid during emergency drive operation in the fixed frequency mode or in the PID control mode.

Input signal status	Fixed frequency mode	PID control mode
Valid	OH, X31 <sup>*1</sup> , X32, X41 <sup>*1</sup> , TRG, TRC, X51, RES, X70, X71	OH, X31 <sup>*1</sup> , X32, X41 <sup>*1</sup> , TRG, TRC, X51, RES, X70, X71
Held	RT, X9, X17, X18, MC, SQ, X84	RT, X9, X17, X18, MC, SQ, X64, X65, X66, X67, X79, X84
Always-ON	—	X14, X77, X78, X80

<sup>\*1</sup> The signal is available only for the FR-A800-LC.

## ◆ Emergency drive status monitor

- Set "68" in **Pr.52, Pr.774 to Pr.776, Pr.992** to monitor the status of the emergency drive on the operation panel.
- Description of the status monitor

Operation panel indication	Description	
	Emergency drive setting	Emergency drive operating status
0	Emergency drive function setting is not available.	—
1	Electronic bypass during emergency drive operation is disabled.	During normal operation
2		Operating properly
3		A certain alarm is occurring. <sup>*2</sup>
4		Emergency drive in operation
5		A critical fault is occurring. The operation is being continued by the retry.
11	Electronic bypass during emergency drive operation is enabled.	During normal operation
12		Operating properly
13		A certain alarm is occurring. <sup>*2</sup>
14		Emergency drive in operation
15		A critical fault is occurring. The operation is being continued by the retry.
20 <sup>*1</sup>		Electronic bypass is started during emergency drive (during acceleration/ deceleration to the switchover frequency).
30 <sup>*1</sup>		During electronic bypass during emergency drive (waiting during the interlock time).
40 <sup>*1</sup>		During commercial power supply operation during emergency drive

<sup>\*1</sup> The first digit remains the same as the previous numerical value (fault condition).

<sup>\*2</sup> "A certain alarm" means a protective function disabled during emergency drive shown in the tables on [page 7](#).

## ⚠ CAUTION

- When the emergency drive operation is performed, the operation is continued or the retry is repeated even when a fault occurs, which may damage or burn the inverter and motor. Before restarting the normal operation after using this function, make sure that the inverter and motor have no fault. Any damage of the inverter or the motor caused by using the emergency drive function is not covered by the warranty even within the guarantee period.

## 2 Forward rotation output (Y30) signal and Reverse rotation output (Y31) signal

---

The Forward rotation output (Y30) signal and Reverse rotation output (Y31) signal become available under encoder feedback control.

- Under Vector control or encoder feedback control, the Forward rotation output (Y30) signal or the Reverse rotation output (Y31) signal is output according to the actual rotation direction of the motor.

### NOTE

- For the details on the Y30 and Y31 signals, refer to the Instruction Manual (Detailed) or the Instruction Manual (Function).
-

# FR-A800/A800 Plus Series

## Instruction Manual Supplement

### 1 Internal storage device fault (E.PE6)

The operation of the storage device in the inverter can be checked.

If a data fault occurs in the storage device in the inverter, the protective function (E.PE6) is activated.

When the read value of **Pr.890** is "7" or smaller, an inverter reset after All parameter clear can return the operation to normal. (The parameters that had been changed before All parameter clear must be set again.)

Operation panel indication	E.PE6	E. PEE	FR-LU08 indication	Fault
<b>Name</b>	Internal storage device fault			
<b>Description</b>	This protective function is activated by an inverter reset if writing data fails due to power-OFF or a data fault occurs in the storage device during parameter operations <sup>*1</sup> .			
<b>Check point</b>	Check if the power was turned OFF during parameter operations.			
<b>Corrective action</b>	Check the power supply or the devices on the power system to check that the devices have no fault. <ul style="list-style-type: none"> <li>When E.PE6 occurs due to power-OFF during parameter operations: Check the read value of <b>Pr.890</b>. When the value is "7" or smaller, perform All parameter clear and then an inverter reset. The parameters that had been changed before All parameter clear must be set again.</li> <li>When E.PE6 occurs due to other reason (such as turning OFF/ON the power or an inverter reset): Contact your sales representative.</li> </ul>			

\*1 For example, when parameter clear, All parameter clear, Parameter copy, or offline auto tuning is performed in the inverter, or when parameter batch write is performed in FR Configurator2.

#### NOTE

- "E.PE6" does not activate the retry function.
- "E.PE6" outputs the Fault output 3 (Y91) signal.
- "E.PE6" turns OFF the Safety monitor output (SAFE) signal.
- "E.PE6" is not cleared by turning ON the Fault clear (X51) signal.
- "E.PE6" is not activated during emergency drive operation.
- The communication data code for "E.PE6" is 172 (HAC).

### ◆ Checking faulty area in the internal storage device

When E.PE6 occurs, faulty area in the internal storage device can be checked by reading **Pr.890**.

Pr.	Name	Initial value	Setting range	Description
<b>890</b> <b>H325</b>	<b>Internal storage device status indication</b>	0	(0 to 9999)	A faulty area detected by self-check function can be indicated in the internal storage device.



- Use the read value of **Pr.890** to check the faulty area.
- The following table shows faulty areas indicated by the read value of **Pr.890**. Some read values indicate that there are multiple faulty areas. (For example, the read value "7" indicates that all the areas described in No. 1 to No. 3 are faulty.)

No.	Read value	Description
1	1, 3, 5, 7	Storage area other than the area for parameter settings is faulty (such as area for the set frequency). (When All parameter clear is performed, the set frequency, remotely-set frequency, host name for Ethernet communication, position pulse, multi-revolution counter, and offline auto tuning data are cleared.)
2	2, 3, 6, 7	Storage area for standard parameter settings is faulty.
3	4, 5, 6, 7	Storage area for communication parameter settings is faulty.
4	8 to 9999	Area for manufacturer setting

## 2 Note for terminal P3 (200/400 V class only)

Some descriptions about terminal P3 are incorrect in the Instruction Manual. The descriptions are corrected as follows.

### ◆ Details on the main circuit terminals

Use terminal P3 only when a brake resistor is connected.

[Incorrect]

Terminal symbol	Terminal name	Terminal function description
P3, PR	Brake resistor connection for FR-A820-00770(15K) to 01250(22K), or FR-A840-00470(18.5K) to 01800(55K)	Connect an optional brake resistor across terminals P3 and PR. Connecting a brake resistor increases the regenerative braking capability.
P/+, N/-	Brake unit connection	Connect the brake unit (FR-BU2, FR-BU, BU), power regeneration common converter (FR-CV), power regeneration converter (MT-RC), high power factor converter (FR-HC2), multifunction regeneration converter (FR-XC), or DC power supply (under DC feeding mode). When connecting multiple inverters, FR-A820-00770(15K) to 01250(22K) or FR-A840-00470(18.5K) to 01800(55K), in parallel using the FR-CV, FR-HC2, or FR-XC, always use either terminal P/+ or P3 for the connection. (Do not use terminals P/+ and P3 together.) Do not connect the DC power supply between terminals P3 and N/-. Use terminals P/+ and N/- for DC feeding.
P3, N/-	Brake unit connection for FR-A820-00770(15K) to 01250(22K), or FR-A840-00470(18.5K) to 01800(55K)	Do not connect the DC power supply between terminals P3 and N/-. Use terminals P/+ and N/- for DC feeding.

[Correct]

Terminal symbol	Terminal name	Terminal function description
P3, PR	Brake resistor connection for FR-A820-00770(15K) to 01250(22K), or FR-A840-00470(18.5K) to 01800(55K)	Connect an optional brake resistor across terminals P3 and PR. Connecting a brake resistor increases the regenerative braking capability.
P/+, N/-	Brake unit connection	Connect the brake unit (FR-BU2, FR-BU, BU), power regeneration common converter (FR-CV), power regeneration converter (MT-RC), high power factor converter (FR-HC2), multifunction regeneration converter (FR-XC), or DC power supply (under DC feeding mode).

### ◆ Terminal connection diagrams

In the terminal connection diagrams, the wiring of the optional brake unit is corrected as follows.

[Incorrect]

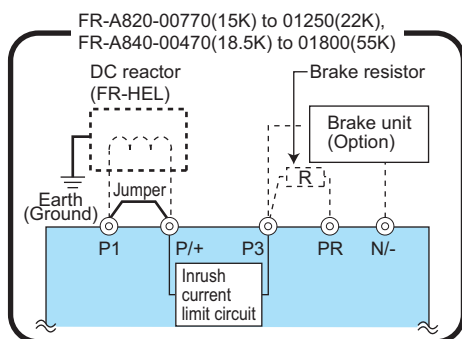

[Correct]

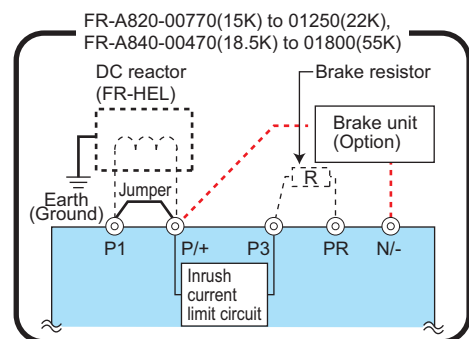

## ◆ Connection of stand-alone option units

When the brake unit (FR-BU2, FR-BU, BU), power regeneration common converter (FR-CV), power regeneration converter (MT-RC), high power factor converter (FR-HC2), multifunction regeneration converter (FR-XC), or DC power supply (under DC feeding mode) is connected, use terminal P/+ of the inverter. (Do not use terminal P3.) The following diagram shows the connection example with the FR-BU2 (GRZG type discharging resistor).

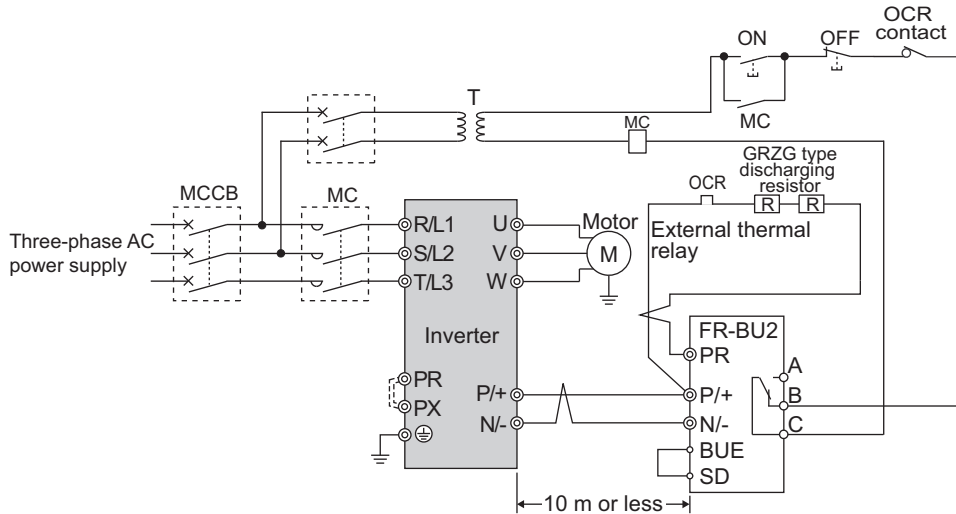

Connection example with the FR-BU2 (GRZG type discharging resistor)

# FR-A800/A800 Plus Series

## Instruction Manual Supplement

---

### 1 Monitoring terminals S1 and S2 (FR Configurator2)

---

---

Graph display using FR Configurator2 is supported for terminals S1 and S2 (data from the high speed sampling and the USB trace file).

The state of terminals S1 and S2 can be displayed in graph form using FR Configurator2.

The FR Configurator2 version 1.28E or later supports graph display for terminals S1 and S2.

For details on FR Configurator2, refer to the FR Configurator2 Instruction Manual.

#### ◆ Digital source (monitor item) selection

- Terminals S1 and S2 can be selected as digital sources for the trace function.
- Select the digital sources (input/output signals) to be set to **Pr.1038 to Pr.1045** from the following table. When a value other than the ones in the following table is set, "0" (OFF) is applied for indication.

Setting value	Signal name
1	STF
2	STR
3	AU
4	RT
5	RL
6	RM
7	RH
8	JOG
9	MRS
10	STP(STOP)
11	RES
12	CS
15	S2
16	S1

Setting value	Signal name
21	X0
22	X1
23	X2
24	X3
25	X4
26	X5
27	X6
28	X7
29	X8
30	X9
31	X10
32	X11
33	X12
34	X13
35	X14
36	X15
37	DY

Setting value	Signal name
101	RUN
102	SU
103	IPF
104	OL
105	FU
106	ABC1
107	ABC2
121	DO0
122	DO1
123	DO2
124	DO3
125	DO4
126	DO5
127	DO6
128	RA1
129	RA2
130	RA3

### 2 Note for use with the Type E combination motor controller

---

---

When Appendix "Instructions for UL and cUL" in the Instruction Manual (Startup) mentions the Type E combination motor controller, only the MMP-T series controllers with the UL mark affixed are applicable for certification.

# FR-A800/A800 Plus Series

## Instruction Manual Supplement

### 1 Earth (ground) fault detection at start / restricting reset method for an earth (ground) fault

The reset method for the output side earth (ground) fault overcurrent (E.GF) can be restricted.

- Select whether to enable or disable the earth (ground) fault detection at start. When enabled, the earth (ground) fault detection is performed immediately after a start signal input to the inverter.
- Select whether to restrict the reset method for an earth (ground) fault.

Pr.	Name	Initial value	Setting range	Description	
				Earth (ground) fault	Reset method
249 H101	Earth (ground) fault detection at start	0	0	Not detected at start	Not restricted
			1	Detected at start	
			2		Restricted

#### ◆ Selecting whether to perform the earth (ground) fault detection at start

- If an earth (ground) fault is detected at start while **Pr.249** = "1 or 2", the output side earth (ground) fault overcurrent (E.GF) is detected and output is shut off.
- Earth (ground) fault detection at start is enabled under V/F control and Advanced magnetic flux vector control.
- When the **Pr.72 PWM frequency selection** setting is high, enable the earth (ground) fault detection at start.

#### NOTE

- Because the detection is performed at start, output is delayed for approx. 20 ms every start.
- Use **Pr.249** to enable/disable the earth (ground) fault detection at start. During operation, earth (ground) faults are detected regardless of the **Pr.249** setting.

#### ◆ Restricting reset method for an earth (ground) fault

- The reset method when the output is shut off due to the output side earth (ground) fault overcurrent (E.GF) can be restricted. When E.GF occurs while **Pr.249** = "2", E.GF can be reset only by turning OFF the control circuit power.
- This restriction prevents the inverter from being damaged due to repeated reset operations by the other methods such as entering the RES signal.
- When E.GF occurs while **Pr.249** = "2", the output short-circuit detection (ALM4) signal can be output.
- For the terminal used to output the ALM4 signal, set "23" (positive logic) or "123" (negative logic) in any of **Pr.190 to Pr.196 (Output terminal function selection)**.
- If **Pr.249** is set to "2" while the retry function is enabled (**Pr.67** is not set to "0"), no retry is performed even when E.GF occurs.
- If **Pr.249** is set to "2" while the automatic bypass switching after inverter fault is enabled (**Pr.138** is not set to "1"), the operation is not switched to the commercial power supply operation even when E.GF occurs.

#### NOTE

- Changing the terminal assignment using **Pr.190 to Pr.196 (Output terminal function selection)** may affect the other functions. Set parameters after confirming the function of each terminal.
- E.GF is not cleared by turning ON the Fault clear (X51) signal when **Pr.249** = "2".
- If E.GF occurs during emergency drive operation when **Pr.249** = "2", the output is shut off.

## 2 Output short-circuit fault (E.SCF)

Select the reset operation and fault indication for an output short-circuit.

Pr.	Name	Initial value	Setting range	Description	
				Operation after detection	Reset method
521 H194	Output short-circuit detection	0	0	E.OC1 to E.OC3	Not restricted
			1	E.SCF	Restricted

- The fault indication for an output short-circuit (E.OC1 to E.OC3, and E.SCF) can be changed by the **Pr.521** setting.
- When an output short-circuit is detected while **Pr.521** = "1", E.SCF is displayed and the inverter output is shut off.
- When E.SCF occurs while **Pr.521** = "1", E.SCF can be reset only by turning OFF the control circuit power. (E.OC1 to E.OC3 can be reset by any reset method.)
- This restriction prevents the inverter from being damaged due to repeated reset operations by the other methods such as entering the RES signal.
- When E.SCF occurs, the output short-circuit detection (ALM4) signal can be output.
- For the terminal used to output the ALM4 signal, set "23" (positive logic) or "123" (negative logic) in any of **Pr.190 to Pr.196 (Output terminal function selection)**.
- If the automatic bypass switching after inverter fault is enabled (**Pr.138** is not set to "1"), the operation is not switched to the commercial power supply operation even when E.SCF occurs.

Operation panel indication	E.SCF	<i>E. SCF</i>	FR-LU08 indication	Fault
<b>Name</b>	Output short-circuit fault			
<b>Description</b>	The inverter output is shut off when an output short-circuit is detected while <b>Pr.521</b> = "1". When <b>Pr.521</b> = "0" (initial value), E.OC1, E.OC2, or E.OC3 appears when an output short-circuit is detected.			
<b>Check point</b>	Check for output short-circuit.			
<b>Corrective action</b>	Check the wiring to make sure that any output short circuit does not occur, then turn OFF the control circuit power to reset the inverter.			

### NOTE

- When short-circuit resistance is large, the current does not reach the short-circuit detection level. In such a case, an output short-circuit cannot be detected.
- Changing the terminal assignment using **Pr.190 to Pr.196 (Output terminal function selection)** may affect the other functions. Set parameters after confirming the function of each terminal.
- E.SCF does not activate the retry function.
- E.SCF is not cleared by turning ON the Fault clear (X51) signal.
- If E.SCF occurs during emergency drive operation, the output is shut off.
- The communication data code for E.SCF is 20 (H14).



### 3 Extended detection time of the output current and zero current

The setting range of the **Pr.151 Output current detection signal delay time** and **Pr.153 Zero current detection time** is extended.

Pr.	Name	Initial value	Setting range	Description
<b>151 M461</b>	<b>Output current detection signal delay time</b>	0 s	0 to 300 s	Set the output current detection time. Enter the time from when the output current reaches the set current or higher to when the Output current detection (Y12) signal is output.
<b>153 M463</b>	<b>Zero current detection time</b>	0.5 s	0 to 300 s	Set the time from when the output current drops to the <b>Pr.152</b> setting or lower to when the Zero current detection (Y13) signal is output.

### 4 Selecting the command interface in the Network operation mode (Pr.338, Pr.339)

- The proximity dog (X76) signal can be input via communication.
- The following table shows the command interface for the function in the Network operation mode, determined by the parameter settings: an external terminal or a communication interface (RS-485 terminals or communication option).

Pr.338 Communication operation command source		0: NET			1: EXT		
Pr.339 Communication speed command source		0: NET	1: EXT	2: EXT	0: NET	1: EXT	2: EXT
X76	Proximity dog	Combined			EXT		

[Explanation of Terms in Table]

EXT: External terminal only

Combined: Either external terminal or communication interface

# FR-A800/A800 Plus Series

## Instruction Manual Supplement

### 1 Compatibility with SF-PR 0.4kW

The SF-PR 0.4kW is supported. Offline auto tuning is not required for operation under Advanced magnetic flux vector control, Real sensorless vector control, or Vector control. (When the wiring length exceeds 30 m, offline auto tuning must be performed.)

#### ◆ Automatic change of Pr.0 Torque boost and Pr.12 DC injection brake operation voltage

- When initial values are set in **Pr.0** and **Pr.12**, the **Pr.0** and **Pr.12** settings are automatically changed to the values in the following table by changing the **Pr.71** setting.

Inverter		Pr.0 value (%) after automatic change								Pr.12 value (%) after automatic change		
FR-A820-□	FR-A840-□	Standard motor <sup>*1</sup>		Constant-torque motor <sup>*2</sup>		SF-PR <sup>*3</sup>				Standard motor <sup>*1</sup>	Constant-torque motor <sup>*2</sup>	SF-PR <sup>*3</sup>
		SLD /LD	ND /HD	SLD /LD	ND /HD	Pr.81 ≠ 2, 4, 6	Pr.81 = 2	Pr.81 = 4	Pr.81 = 6			
00046(0.4K)	00023(0.4K)	6		6		5	8	6.5	7.5	4	4	5
00077(0.75K)	00038(0.75K)	6		6		4	7.4	6	6.4	4	4	4
00105(1.5K)	00052(1.5K)	4		4		3	5.8	5	3.7	4	4	2.5
00167(2.2K)	00083(2.2K)	4		4		2.5	6	4.5	3.3	4	4	2.5
00250(3.7K)	00126(3.7K)	4		4		2.5	6.4	4.5	4.2	4	4	2.5
00340(5.5K)	00170(5.5K)	3		2		2	4.5	3.7	3.3	4	2	2
00490(7.5K)	00250(7.5K)	3		2		2	4.4	4.5	3.8	4	2	2
00630(11K)	00310(11K)	2		2		1.5	3.5	3.3	3.5	2	2	1.5
00770(15K)	00380(15K)	2		2		1.5	4.5	3	3.5	2	2	1.5
00930(18.5K)	00470(18.5K)	2		2		1.5	4	3.2	3	2	2	1.5
01250(22K)	00620(22K)	2		2		1.5	2.5	3.4	3	2	2	1
01540(30K)	00770(30K)	2		2		1	3	2	2.5	2	2	1
01870(37K)	00930(37K)	2		2		1	2	2.5	2.6	2	2	1
02330(45K)	01160(45K)	1.5	2	1.5	2	1	2	2	2.4	2	2	1
03160(55K)	01800(55K)	1.5	2	1.5	2	0.7	2	2	0.7	2	2	1
03800(75K) or higher	02160(75K) or higher	1		1		1	1	1	1	1	1	1

\*1 **Pr.71** = "0, 2 to 6, 20, 23, 24, 40, 43, or 44" (standard motor)

\*2 **Pr.71** = "1, 13 to 16, 50, 53, or 54" (constant-torque motor)

\*3 **Pr.71** = "70, 73, or 74" (SF-PR)

#### NOTE

- When the **Pr.0** and **Pr.12** settings are changed from their initial values, the automatic change is not performed.
- When the SF-PR motor is selected (**Pr.71** = "70, 73, or 74"), the output current may become large due to a small load by setting **Pr.81 Number of motor poles** according to the number of the SF-PR motor poles.
- When the SF-PR motor is used, the output current tends to increase compared with the case where the SF-JR or SF-HR motor is used. Depending on the load conditions, the output current may increase even though the torque boost value has been automatically changed. When the protective function such as the electronic thermal O/L relay (E.THT, E.THM) or stall prevention (OL, E.OLT) is activated, adjust the **Pr.0 Torque boost** according to the load.

## 2 Compatibility with PM motor EM-A series

The PM motor EM-A series (200 V class 0.75kW to 7.5kW) is supported.

Motor model: EM-AMF□		0.75kW	1.5kW	2.2kW	3.7kW	5.5kW	7.5kW
Applicable inverter model FR-A820-□K	SLD	0.4	0.75	1.5	2.2	3.7	5.5
	LD	0.4	0.75	1.5	2.2	3.7	5.5
	ND	0.75	1.5	2.2	3.7	5.5	7.5
	HD	1.5	2.2	3.7	5.5	7.5	11

### 2.1 Selecting the PM sensorless vector control

#### ◆ Initializing the parameters required for the PM sensorless vector control (Pr.998)

- PM parameter initialization sets parameters required for driving an EM-A motor.
- Two methods of the motor parameter initialization are available: using **Pr.998 PM parameter initialization**, and using IPM parameter initialization ("**PM**").

Pr.	Name	Initial value	Setting range	Description	
998 E430	PM parameter initialization	0	0	Parameter setting (in frequencies) for an induction motor	The setting of the motor parameters is changed to the setting required to drive an induction motor.
			3003	Parameter setting (in rotations per minute) for an MM-CF motor	The setting of the motor parameters is changed to the setting required to drive an MM-CF motor.
			3103	Parameter setting (in frequencies) for an MM-CF motor	
			3044	Parameter setting (in rotations per minute) for an EM-A motor	The setting of the motor parameters is changed to the setting required to drive an EM-A motor.
			3144	Parameter setting (in frequencies) for an EM-A motor	
			8009	Parameter setting (in rotations per minute) for an IPM motor other than EM-A/MM-CF (after tuning)	The setting of the motor parameters is changed to the setting required to drive an IPM motor. (Set <b>Pr.71 Applied motor</b> and perform offline auto tuning in advance.)
			8109	Parameter setting (in frequencies) for an IPM motor other than EM-A/MM-CF (after tuning)	
			9009	Parameter setting (in rotations per minute) for an SPM motor (after tuning)	The setting of the motor parameters is changed to the setting required to drive an SPM motor. (Set <b>Pr.71 Applied motor</b> and perform offline auto tuning in advance.)
			9109	Parameter setting (in frequencies) for an SPM motor (after tuning)	

- To use a motor capacity that is one rank lower than the inverter capacity, set **Pr.80 Motor capacity** before performing PM parameter initialization.
- When "3003, 3044, 8009, or 9009" is set in **Pr.998**, the motor speed which was set/monitored in frequencies is set/monitored in motor rotations per minute. To set/monitor in frequencies, set "3103, 3144, 8109, or 9109" in **Pr.998**.
- Set **Pr.998** = "0" to change the PM sensorless vector control parameter settings to the parameter settings required to drive an induction motor.
- When using an IPM motor or SPM motor other than EM-A or MM-CF, set **Pr.998** = "8009, 8109, 9009, or 9109".

**NOTE**

- Make sure to set **Pr.998** before setting other parameters. If the **Pr.998** setting is changed after setting other parameters, some of those parameters are initialized too. (Refer to the "List of the target parameters for the motor parameter initialization".)
- To change back to the parameter settings required to drive an induction motor, perform Parameter clear or All parameter clear.
- Whenever the setting of **Pr.998 PM parameter initialization** is changed from "3003, 3044, 8009, or 9009 (rotations per minute)" to "3103, 3144, 8109, or 9109 (frequency)", and vice versa, all the relevant parameters are initialized. The purpose of **Pr.998** is not to change the display units. Use **Pr.144 Speed setting switchover** to change the display units between rotations per minute and frequency. Using **Pr.144** enables switching the units between rotations per minute and frequency without initializing the settings of the motor parameters.  
Example) Changing the **Pr.144** setting between "6" and "106" switches the display units between frequency and rotations per minute.
- For an inverter out of the capacity range of the EM-A motor, the settings "3044 and 3144" are disabled. For an inverter out of the capacity range of the MM-CF motor, the settings "3003 and 3103" are disabled.
- The PM parameter initialization (**Pr.998**) changes parameter settings for the first motor. When a PM motor is used as the second motor, parameters for the second motor must be set individually.

## ◆ List of the target parameters for the motor parameter initialization (EM-A)

- The parameter settings in the following table are changed to the settings required to perform PM sensorless vector control by selecting PM sensorless vector control with the IPM initialization on the operation panel or with **Pr.998 PM parameter initialization**. The changed settings differ according to the specification (capacity) of the PM motor used.
- Performing Parameter clear or All parameter clear sets back the parameter settings to the settings required to drive an induction motor.

Pr.	Name	Induction motor		PM motor (setting in rotations per minute)	PM motor (setting in frequencies)	Setting increments	
		Pr.998 = "0 (initial value)"		Pr.998 = "3044" (EM-A)	Pr.998 = "3144" (EM-A)	Pr.998 = "3044"	Pr.998 = "0, 3144"
		FM	CA				
1	Maximum frequency	120 Hz		Maximum motor rotations per minute <sup>*2</sup>	Maximum motor frequency <sup>*2</sup>	1 r/min	0.01 Hz
4	Multi-speed setting (high speed)	60 Hz	50 Hz	Rated motor rotations per minute <sup>*2</sup>	Rated motor frequency <sup>*2</sup>	1 r/min	0.01 Hz
9	Electronic thermal O/L relay	Inverter rated current		Rated motor current <sup>*2</sup>		0.01 A	
10	DC injection brake operation frequency	3 Hz		Rated motor rotations per minute × 3% <sup>*2</sup>	Rated motor frequency × 3% <sup>*2</sup>	1 r/min	0.01 Hz
13	Starting frequency	0.5 Hz		Rated motor rotations per minute × 0.5% <sup>*2</sup>	Rated motor frequency × 0.5% <sup>*2</sup>	1 r/min	0.01 Hz
15	Jog frequency	5 Hz		Rated motor rotations per minute × 10% <sup>*2</sup>	Rated motor frequency × 10% <sup>*2</sup>	1 r/min	0.01 Hz
18	High speed maximum frequency	120 Hz		Maximum motor rotations per minute <sup>*2</sup>	Maximum motor frequency <sup>*2</sup>	1 r/min	0.01 Hz
20	Acceleration/deceleration reference frequency	60 Hz	50 Hz	Rated motor rotations per minute <sup>*2</sup>	Rated motor frequency <sup>*2</sup>	1 r/min	0.01 Hz
22	Stall prevention operation level	150%		200%		0.1%	
37	Speed display	0		0		1	
55	Frequency monitoring reference	60 Hz	50 Hz	Rated motor rotations per minute <sup>*2</sup>	Rated motor frequency <sup>*2</sup>	1 r/min	0.01 Hz
56	Current monitoring reference	Inverter rated current		Rated motor current <sup>*2</sup>		0.01 A	
71	Applied motor	0		1140		1	
80	Motor capacity	9999		Motor capacity (EM-A) <sup>*1</sup>		0.01 kW	
81	Number of motor poles	9999		Number of motor poles (EM-A) <sup>*1</sup>		1	
84	Rated motor frequency	9999		Rated motor rotations per minute <sup>*2</sup>	Rated motor frequency <sup>*2</sup>	1 r/min	0.01 Hz
116	Third output frequency detection	60 Hz	50 Hz	Rated motor rotations per minute <sup>*2</sup>	Rated motor frequency <sup>*2</sup>	1 r/min	0.01 Hz
125 (903)	Terminal 2 frequency setting gain frequency	60 Hz	50 Hz	Rated motor rotations per minute <sup>*2</sup>	Rated motor frequency <sup>*2</sup>	1 r/min	0.01 Hz
126 (905)	Terminal 4 frequency setting gain frequency	60 Hz	50 Hz	Rated motor rotations per minute <sup>*2</sup>	Rated motor frequency <sup>*2</sup>	1 r/min	0.01 Hz
144	Speed setting switchover	4		Number of motor poles (EM-A) + 100 <sup>*2</sup>	Number of motor poles (EM-A) <sup>*2</sup>	1	
240	Soft-PWM operation selection	1		0		1	

Pr.	Name	Induction motor		PM motor (setting in rotations per minute)	PM motor (setting in frequencies)	Setting increments	
		Pr.998 = "0 (initial value)"		Pr.998 = "3044" (EM-A)	Pr.998 = "3144" (EM-A)	Pr.998 = "3044"	Pr.998 = "0, 3144"
		FM	CA				
263	Subtraction starting frequency	60 Hz	50 Hz	Rated motor rotations per minute <sup>*2</sup>	Rated motor frequency <sup>*2</sup>	1 r/min	0.01 Hz
266	Power failure deceleration time switchover frequency	60 Hz	50 Hz	Rated motor rotations per minute <sup>*2</sup>	Rated motor frequency <sup>*2</sup>	1 r/min	0.01 Hz
374	Overspeed detection level	9999		Maximum motor rotations per minute × 115% <sup>*2</sup>	Maximum motor frequency × 115% <sup>*2</sup>	1 r/min	0.01 Hz
386	Frequency for maximum input pulse	60 Hz	50 Hz	Rated motor rotations per minute <sup>*2</sup>	Rated motor frequency <sup>*2</sup>	1 r/min	0.01 Hz
422	Position control gain	25 s <sup>-1</sup>		20 s <sup>-1</sup>		1 s <sup>-1</sup>	
505	Speed setting reference	60 Hz	50 Hz	Rated motor frequency <sup>*2</sup>		0.01 Hz	
557	Current average value monitor signal output reference current	Inverter rated current		Rated motor current <sup>*2</sup>		0.01 A	
665	Regeneration avoidance frequency gain	100%		80%		0.1%	
820	Speed control P gain 1	60%		30%		1%	
821	Speed control integral time 1	0.333 s		0.333 s		0.001 s	
824	Torque control P gain 1 (current loop proportional gain)	100%		150%		1%	
825	Torque control integral time 1 (current loop integral time)	5 ms		6.7 ms		0.1 ms	
870	Speed detection hysteresis	0 Hz		Rated motor rotations per minute × 0.5% <sup>*2</sup>	Rated motor frequency × 0.5% <sup>*2</sup>	1 r/min	0.01 Hz
885	Regeneration avoidance compensation frequency limit value	6 Hz		Rated motor rotations per minute × 6% <sup>*2</sup>	Rated motor frequency × 6% <sup>*2</sup>	1 r/min	0.01 Hz
893	Energy saving monitor reference (motor capacity)	Inverter rated capacity		Motor capacity (Pr.80)		0.01 kW	
C14 (918)	Terminal 1 gain frequency (speed)	60 Hz	50 Hz	Rated motor rotations per minute <sup>*2</sup>	Rated motor frequency <sup>*2</sup>	1 r/min	0.01 Hz
1121	Per-unit speed control reference frequency	120 Hz		Maximum motor rotations per minute <sup>*2</sup>	Maximum motor frequency <sup>*2</sup>	1 r/min	0.01 Hz

\*1 When a value other than "9999" is set, the set value is not changed.

\*2 The rated motor rotations per minute (frequency), maximum motor rotations per minute (frequency), number of motor poles, and rated motor current are as follows.

Item	0.75kW	1.5kW or higher
Rated motor rotations per minute (frequency)	3000 r/min (100 Hz)	3000 r/min (150 Hz)
Maximum motor rotations per minute (frequency)	4000 r/min (133.33 Hz)	4000 r/min (200 Hz)
Number of motor poles	4	6
Rated motor current	0.75kW: 3.3 A, 1.5kW: 6.1 A, 2.2kW: 9.3 A, 3.7kW: 16.5 A, 5.5kW: 22.0 A, 7.5kW: 31.0 A	

## NOTE

- When the motor parameter initialization is performed with the setting in units of rotations per minute (Pr.998 = "3044"), the parameters not listed in the table and the monitor items are also set and displayed in rotations per minute.

## ◆ List of the target parameters for the motor parameter initialization (other than EM-A)

- The settings in Pr.10, Pr.422, and Pr.665 are changed to the settings shown in the following table by selecting a motor other than EM-A with the IPM initialization on the operation panel or with Pr.998 PM parameter initialization. For other parameters whose settings are to be changed, refer to the Instruction Manual (Detailed).

Pr.	Name	Induction motor		PM motor (setting in rotations per minute)	PM motor (setting in frequencies)	Setting increments	
		Pr.998 = "0 (initial value)"		Pr.998 = "3003" (MM-CF) Pr.998 = "8009, 9009" (other than EM-A/MM-CF)	Pr.998 = "3103" (MM-CF) Pr.998 = "8109, 9109" (other than EM-A/MM-CF)	Pr.998 = "3003, 8009, 9009"	Pr.998 = "0, 3103, 8109, 9109"
		FM	CA				
10	DC injection brake operation frequency	3 Hz		3 Hz <sup>*1</sup>	3 Hz	1 r/min	0.01 Hz
422	Position control gain	25 s <sup>-1</sup>		25 s <sup>-1</sup>		1 s <sup>-1</sup>	
665	Regeneration avoidance frequency gain	100%		100%		0.1%	

\*1 The setting value is converted from frequency to rotations per minute. (It differs according to the number of motor poles.)

## 2.2 Offline auto tuning for a PM motor (motor constant tuning)

The offline auto tuning enables the optimal operation of a PM motor.

- Automatic measurement of motor constants (offline auto tuning) enables optimal operation of motors for PM sensorless vector control even when motor constants vary or when the wiring distance is long.

### ◆ Before performing offline auto tuning

Check the following points before performing offline auto tuning:

- The PM sensorless vector control is selected.
- A motor is connected. (Check that the motor is not rotated by an external force during tuning.)
- The maximum frequency under PM sensorless vector control is 400 Hz.
- The motor may rotate slightly even if the offline auto tuning without the motor rotating (**Pr.96 Auto tuning setting/status** = "11") is selected. (It does not affect the tuning performance.)

Fix the motor securely with a mechanical brake, or before tuning, make sure that it is safe even if the motor rotates. (Caution is required especially in vertical lift applications.)

- Tuning is not available during position control under PM sensorless vector control.

### ◆ Settings

- To perform tuning, set the following parameters about the motor.

First motor Pr.	Second motor Pr.	Name	Setting for EM-A
80	453	Motor capacity	Parameters for the first motor are set by IPM parameter initialization.
81	454	Number of motor poles	
9	51	Electronic thermal O/L relay	
84	457	Rated motor frequency	
71	450	Applied motor	
83	456	Rated motor voltage	Initial value (200 V)
96	463	Auto tuning setting/status	11

#### NOTE

- Under PM sensorless vector control, tuning cannot be performed even when **Pr.96** = "101". When the EM-A is set to the applied motor, tuning cannot be performed even when **Pr.96** = "1 or 101".

- Use the following parameters in the initial settings ("9999").

First motor Pr.	Second motor Pr.	Name	Setting for EM-A
702	743	Maximum motor frequency	9999 (initial value)
707	744	Motor inertia (integer)	9999 (initial value)
724	745	Motor inertia (exponent)	
725	746	Motor protection current level	9999 (initial value)

### ◆ Performing tuning

#### Point

- Before performing tuning, check the monitor display of the operation panel or parameter unit if the inverter is in the state ready for tuning. The motor starts by turning ON the start command while tuning is unavailable.

- In the PU operation mode, press  /  on the operation panel.

In the external operation mode, turn ON the start command (STF signal or STR signal). Tuning starts.

For details on the tuning procedure, refer to "5.13.4 Offline auto tuning for a PM motor (motor constants tuning)" in the Instruction Manual (Detailed).

### ◆ Parameters updated by tuning results after tuning

First motor Pr.	Second motor Pr.	Name	Description
90	458	Motor constant (R1)	Resistance per phase
717	741	Starting resistance tuning compensation	
96	463	Auto tuning setting/status	

## ◆ Tuning adjustment (Pr.1002)

- The overcurrent protective function may be activated during Lq tuning for an easily magnetically saturated motor (motor with a large Lq decay ratio). In such case, adjust the target flowing current used for tuning with **Pr.1002 Lq tuning target current adjustment coefficient**.

## ◆ Changing the motor constants

- The motor constants can be set directly when the motor constants are known in advance, or by using the data measured during offline auto tuning.
- According to the **Pr.71 (Pr.450)** setting, the range of the motor constant parameter setting values and units can be changed. The changed settings are stored in the EEPROM as the motor constant parameters.

## ◆ Changing the motor constants (when setting motor constants in units of Ω, mH, or A)

- Set **Pr.71** as follows.

Motor		Pr.71 setting
PM motor	EM-A	1140

- Set desired values as the motor constant parameters.

First motor Pr.	Second motor Pr.	Name	Setting range	Setting increments	Initial value
90	458	Motor constant (R1)	0 to 50 Ω, 9999	0.001 Ω	9999
92	460	Motor constant (L1)/d-axis inductance (Ld)	0 to 500 mH, 9999	0.01 mH	
93	461	Motor constant (L2)/q-axis inductance (Lq)	0 to 500 mH, 9999	0.01 mH	
706	738	Induced voltage constant (phi f)	0 to 5000 mV (rad/s), 9999	0.1 mV (rad/s)	
859	860	Torque current/Rated PM motor current	0 to 500 A, 9999	0.01 A	
1412	1413	Motor induced voltage constant (phi f) exponent	0 to 2, 9999	1	

### NOTE

- If "9999" is set, tuning data will be invalid. When the EM-A motor is selected, the EM-A constant is used.
- To change a motor induced voltage constant of PM motors, the setting in **Pr.706 Induced voltage constant (phi f)** or **Pr.738 Second motor induced voltage constant (phi f)** must be changed. If the constant after the change exceeds the setting range of **Pr.706** or **Pr.738** (0 to 5000 mV (rad/s)), set **Pr.1412 Motor induced voltage constant (phi f) exponent** or **Pr.1413 Second motor induced voltage constant (phi f) exponent**. Set a value in the exponent n in the formula, **Pr.706 (Pr.738) × 10<sup>n</sup>** [mV (rad/s)], to set the induced voltage constant (phi f).
- When **Pr.1412 (Pr.1413) = "9999"**, the motor induced voltage constant is as set in **Pr.706 (Pr.738)**. (No exponent setting)

## 2.3 Selection of the control method and the control mode

- Select a control method (and a control mode) from V/F control, Advanced magnetic flux vector control (speed control), Real sensorless vector control (speed control, torque control), Vector control (speed control, torque control, position control), and PM sensorless vector control (speed control, position control).

Settings of Pr.80 (Pr.453) and Pr.81 (Pr.454)	Pr.71 (Pr.450)	Pr.800 setting*1	Pr.451 setting*1	Control method	Control mode	Remarks	
Other than 9999	Induction motor	For details on the settings, refer to the Instruction Manual (Detailed).					
	EM-A, MM-CF*2	9, 109	—	PM sensorless vector control test operation			
		13, 113			PM sensorless vector control	Position control*4	—
		14, 114				Speed control / position control switchover*4	MC signal ON: position control MC signal OFF: speed control
		20 (initial value), 110	20, 110			Speed control	—
	PM motor (other than EM-A/MM-CF)	0, 100*5			Vector control*7	Speed control	—
		3, 103				Position control	—
		4, 104*6			Speed control / position control switchover		MC signal ON: position control MC signal OFF: speed control
		9, 109	—	PM sensorless vector control test operation			
		20 (initial value), 110*8	20, 110*8	PM sensorless vector control	Speed control	—	
PM motor	—	9999 (initial value)	The setting value of Pr.800 is used for the second motor. (PM sensorless vector control (speed control) when Pr.800="9 or 109")				
9999*3	—	—	V/F control				

\*1 The setting values of 100 and above are used when the fast-response operation is selected.

\*2 For the EM-A or MM-CF motor, the setting other than "9, 13, 14, 109, 113, 114, or 9999" in Pr.800 (Pr.451) has the same meaning as the setting "20 or 110" in Pr.800 (Pr.451) (speed control under PM sensorless vector control).

\*3 V/F control is applied when Pr.80 or Pr.81 is "9999", regardless of the Pr.800 setting. When Pr.71 is set to the EM-A or MM-CF, PM sensorless vector control is enabled even if Pr.80 ≠ "9999" or Pr.81 = "9999". (When other PM motors are used, set Pr.80 and Pr.81 according to the motor. Otherwise, proper operation cannot be performed.)

\*4 Setting Pr.788 (Pr.747) = "0" (low-speed range torque characteristic disabled) selects speed control.

\*5 The operation for the setting of "0 or 100" is performed when "1, 2, 6, 101, 102, or 106" is set.

\*6 The operation for the setting of "4 or 104" is performed when "5 or 105" is set.

\*7 Speed control under PM sensorless vector control is applied if an option for vector control for PM motor is not installed.

\*8 The operation for the setting of "20 or 110" is performed when "10 to 14 or 111 to 114" is set.

## 2.4 Low-speed range torque characteristics selection

### ◆ When the low-speed range high-torque characteristic is enabled (Pr.788 Low speed range torque characteristic selection = "9999 (initial value)")

- The high frequency superposition control provides enough torque in the low-speed range operation.
- The low-speed range high-torque characteristic is enabled for the EM-A and MM-CF motors.

### ◆ When the low-speed range high-torque characteristic is disabled (Pr.788 Low speed range torque characteristic selection = "0")

- The current synchronization operation reduces much motor noise compared with the high frequency superposition control.
- Since the torque in a low-speed range is low, use this setting for an operation with light start-up load.

#### NOTE

- Position control under PM sensorless vector control is not available when the current synchronization operation is selected. Zero speed and servo lock are also disabled during current synchronization operation.



# 2.5 Applied motor

By setting the applied motor type, the thermal characteristic appropriate for the motor can be selected.

When using a constant-torque or PM motor, the electronic thermal O/L relay is set according to the motor.

When the Advanced magnetic flux vector control, Real sensorless vector control, Vector control, or PM sensorless vector control is selected, the motor constant necessary for control (SF-PR, SF-JR, SF-HR, SF-JRCA, SF-HRCA, SF-V5RU (1500 r/min series), EM-A, MM-CF, etc.) is also selected at the same time.

Pr.	Name	Initial value	Setting range	Description
<b>71</b> <b>C100</b>	<b>Applied motor</b>	0	0 to 6, 13 to 16, 20, 23, 24, 30, 33, 34, 40, 43, 44, 50, 53, 54, 70, 73, 74, 330, 333, 334, <b>1140</b> , 8090, 8093, 8094, 9090, 9093, 9094	By selecting a motor, the thermal characteristic and motor constant of each motor are set.
<b>450</b> <b>C200</b>	<b>Second applied motor</b>	9999	0, 1, 3 to 6, 13 to 16, 20, 23, 24, 30, 33, 34, 40, 43, 44, 50, 53, 54, 70, 73, 74, 330, 333, 334, <b>1140</b> , 8090, 8093, 8094, 9090, 9093, 9094	Set this parameter when using the second motor (the same specifications as <b>Pr.71</b> ).
			9999	The function is disabled.

## ◆ Setting the applied motor

- Refer to the following list and set the parameters according to the applied motor.

Pr.71	Pr.450	Motor	Motor constant value range (increment)	Electronic thermal O/L relay function		
				Standard	Constant-torque	PM
0 <sup>*1</sup>	0	Standard motor (such as SF-JR)		○		
1		Constant-torque motor (SF-JRCA, etc.) SF-V5RU (other than the 1500 r/min series)	<b>Pr.82 (Pr.455), Pr.859 (Pr.860)</b> • 0 to 500 A, 9999 (0.01 A) <sup>*3</sup> • 0 to 3600 A, 9999 (0.1 A) <sup>*4</sup>		○	
2	—	Standard motor (such as SF-JR) Adjustable 5 points V/F	<b>Pr.90 (Pr.458), Pr.91 (Pr.459)</b> • 0 to 50 Ω, 9999 (0.001 Ω) <sup>*3</sup> • 0 to 400 mΩ, 9999 (0.01 mΩ) <sup>*4</sup>	○		
20		Mitsubishi Electric standard motor (SF-JR 4P 1.5kW or lower)	• 0 to 50 Ω, 9999 (0.001 Ω) <sup>*3</sup> • 0 to 400 mΩ, 9999 (0.01 mΩ) <sup>*4</sup>		○	
30		Vector control dedicated motor SF-V5RU (1500 r/min series) SF-THY	<b>Pr.92 (Pr.460), Pr.93 (Pr.461) (Induction motor)</b> • 0 to 6000 mH, 9999 (0.1 mH) <sup>*3</sup> • 0 to 400 mH, 9999 (0.01 mH) <sup>*4</sup>		○	
40		Mitsubishi Electric high-efficiency motor SF-HR	<b>Pr.92 (Pr.460), Pr.93 (Pr.461) (PM motor)</b> • 0 to 6000 mH, 9999 (0.1 mH) <sup>*3</sup> • 0 to 400 mH, 9999 (0.01 mH) <sup>*4</sup>	○		
50		Mitsubishi Electric constant-torque motor SF-HRCA	• 0 to 500 mH, 9999 (0.01 mH) <sup>*3</sup> • 0 to 50 mH, 9999 (0.001 mH) <sup>*4</sup>		○	
70		Mitsubishi Electric high-performance energy-saving motor SF-PR	<b>Pr.94 (Pr.462)</b> • 0 to 100%, 9999 (0.1%) <sup>*3</sup> • 0 to 100%, 9999 (0.01%) <sup>*4</sup>		○	
330 <sup>*2</sup>		IPM motor MM-CF	<b>Pr.706 (Pr.738)</b> • 0 to 5000 mV (rad/s), 9999 (0.1 mV (rad/s))			○ (MM-CF)
1140 <sup>*2</sup>		PM motor EM-A				○ (EM-A)
8090		IPM motor (other than EM-A/MM-CF)			○	
9090		SPM motor			○	

Pr.71	Pr.450	Motor	Motor constant value range (increment)	Electronic thermal O/L relay function		
				Standard	Constant-torque	PM
3 (4) <sup>*5</sup>		Standard motor (such as SF-JR)	<b>Pr.82 (Pr.455), Pr.859 (Pr.860), Pr.90 (Pr.458), Pr.91 (Pr.459), Pr.92 (Pr.460), Pr.93 (Pr.461), Pr.94 (Pr.462), Pr.706 (Pr.738)</b> • Internal data value 0 to 65534, 9999 (1) The display increment can be changed in <b>Pr.684</b> .	○		
13 (14) <sup>*5</sup>		Constant-torque motor (SF-JRCA, etc.) SF-V5RU (other than the 1500 r/min series)		○		
23 (24) <sup>*5</sup>		Mitsubishi Electric standard motor (SF-JR 4P 1.5kW or lower)		○		
33 (34) <sup>*5</sup>		Vector control dedicated motor SF-V5RU (1500 r/min series) SF-THY		○		
43 (44) <sup>*5</sup>		Mitsubishi Electric high-efficiency motor SF-HR		○		
53 (54) <sup>*5</sup>		Mitsubishi Electric constant-torque motor SF-HRCA		○		
73 (74) <sup>*5</sup>		Mitsubishi Electric high-performance energy-saving motor SF-PR		○		
333 (334) <sup>*2*5</sup>		IPM motor MM-CF				○ (MM-CF)
8093 (8094) <sup>*5</sup>		IPM motor (other than EM-A/MM-CF)		○		
9093 (9094) <sup>*5</sup>		SPM motor		○		
5		Standard motor	Wye connection <b>Pr.82 (Pr.455), Pr.859 (Pr.860)</b> • 0 to 500 A, 9999 (0.01 A) <sup>*3</sup> • 0 to 3600 A, 9999 (0.1 A) <sup>*4</sup> <b>Pr.90 (Pr.458), Pr.91 (Pr.459)</b> • 0 to 50 Ω, 9999 (0.001 Ω) <sup>*3</sup> • 0 to 400 mΩ, 9999 (0.01 mΩ) <sup>*4</sup>	○		
15		Constant-torque motor		○		
6		Standard motor	Delta connection <b>Pr.92 (Pr.460), Pr.93 (Pr.461)</b> • 0 to 50 Ω, 9999 (0.001 Ω) <sup>*3</sup> • 0 to 3600 mΩ, 9999 (0.1 mΩ) <sup>*4</sup> <b>Pr.94 (Pr.462)</b> • 0 to 500 Ω, 9999 (0.01 Ω) <sup>*3</sup> • 0 to 100 Ω, 9999 (0.01 Ω) <sup>*4</sup>	○		
16		Constant-torque motor		○		
—	9999 <sup>*1</sup>	No second applied motor				

\*1 Initial value.

\*2 The setting is available only for the inverters with the capacity applicable for the motor.

\*3 For the FR-A820-55K(03160) or lower and FR-A840-55K(01800) or lower.

\*4 For the FR-A820-75K(03800) or higher and FR-A840-75K(02160) or higher.

\*5 The same operation is performed for the both settings.

## 2.6 Electronic thermal O/L relay (Pr.9)

- This function detects the overload (overheat) of the motor and shuts off the inverter output by stopping the operation of the transistor at the inverter output side.
- Set the rated current (A) of the motor in **Pr.9 Electronic thermal O/L relay**. Performing IPM parameter initialization automatically sets the rated current of the IPM motor.
- Set "0" in **Pr.9** to avoid activating the electronic thermal relay function; for example, when using an external thermal relay for the motor. (Note that the output transistor protection of the inverter is activated. (E.THT))
- Operational characteristic of the electronic thermal O/L relay when the EM-A motor is used

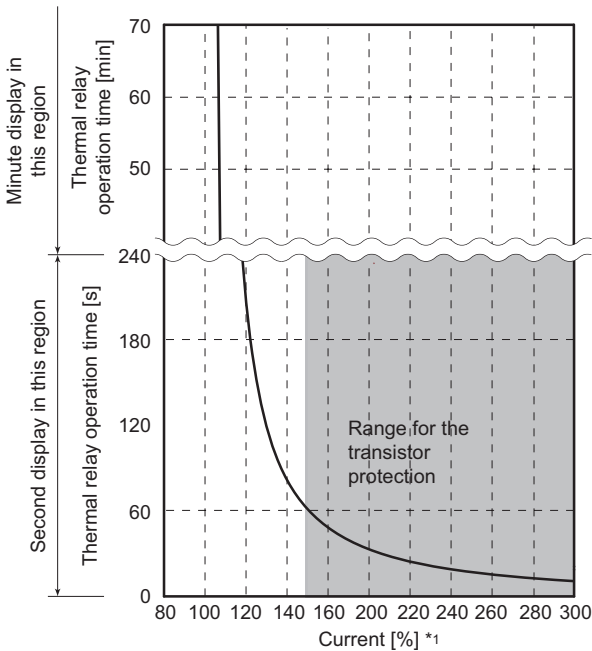

Protective function activated area: the area right of the characteristic curve

Normal operation area: the area left of the characteristic curve

\*1 The % value denotes the percentage to the rated motor current.

### NOTE

- The internal accumulated heat value of the electronic thermal relay function is reset to the initial value by the inverter's power reset or reset signal input. Avoid unnecessary reset and power-OFF.
- The transistor protection thermal O/L relay is activated early when the **Pr.72 PWM frequency selection** setting is increased.

## 2.7 Brake sequence function

The brake sequence function is available when the EM-A motor is used.

For details on the brake sequence function, refer to "5.14.3 Brake sequence function" in the Instruction Manual (Detailed).

## 2.8 Automatic restart after instantaneous power failure function

The automatic restart after instantaneous power failure function is available when the EM-A motor is used.

When the EM-A motor is used, the frequency search is available at 450 r/min or higher.

For details on the automatic restart after instantaneous power failure function, refer to "5.14.15 Automatic restart after instantaneous power failure/flying start with a PM motor" in the Instruction Manual (Detailed).

# MITSUBISHI ELECTRIC CORPORATION

HEAD OFFICE: TOKYO BUILDING 2-7-3, MARUNOUCHI, CHIYODA-KU, TOKYO 100-8310, JAPAN

<b>Model</b>	<b>FR-A800 Instruction Manual (Detailed)</b>
<b>Model code</b>	<b>1A2-P52</b>